



HEARTH PRODUCTS

P/N 875021M Rev. K 01/2011

This manual is part of a set of two supporting this product. Refer to P/N 850017M for Installation Instructions. Ce manuel est disponible en français, simplement en faire la demande. Numéro de la pièce 875021CF.

WHAT'S INSIDE

Table of Contents 2
Safety and Your Fireplace 2
FREE Safety Guard Offer (Protects Against Burns) 2
Important Safety Information 4
Attaching the Safety-in-Operation Warnings 5
[EN FRANÇAIS] L'information de sûreté importante 3-4
Apposition des mises en garde relatives à la sécurité d'utilisation 5
[EN ESPAÑOL] Información importante de seguridad 3-4
Colocación de advertencias de seguridad en operación 5

CARE AND OPERATION INSTRUCTIONS

EDV Direct-Vent Gas Fireplaces

ELITE™ SERIES

MODELS

MILLIVOLT:

ELECTRONIC:

- EDV3530CNM-B EDV3530CPM-B
EDV4035CNM-B EDV4035CPM-B
EDV4540CPM-B EDV4540CPM-B

- EDV3530CNE-B
EDV4035CNE-B
EDV4540CNE-B



OTL Report No. 116-F-05-5



INSTALLER: Leave this manual with the appliance.
CONSUMER: Retain this manual for future reference.
INSTALLATEUR : Laissez cette notice avec l'appareil.
CONSOMMATEUR : Conservez cette notice pour consultation ultérieure.



WARNING / AVERTISSEMENT / AVISO

- HOT GLASS WILL CAUSE BURNS.
DO NOT TOUCH GLASS UNTIL COOLED.
NEVER ALLOW CHILDREN TO TOUCH GLASS.



- UNE SURFACE VITRÉE CHAUDE PEUT CAUSER DES BRÛLURES.
LAISSER REFROIDIR LA SURFACE VITRÉE AVANT D'Y TOUCHER.
NE PERMETTEZ JAMAIS À UN ENFANT DE TOUCHER LA SURFACE VITRÉE.

- EL VIDRIO CALIENTE CAUSARÁ QUEMADURAS.
USTED DEBE NUNCA TOCAR EL VIDRIO CALIENTE.
LOS NIÑOS DEBEN NUNCA TOCAR EL VIDRIO.

WARNING: If the information in these instructions is not followed exactly, a fire or explosion may result, causing property damage, personal injury, or death.

- Do not store or use gasoline or other flammable vapors and liquids in the vicinity of this or any other appliance.
- WHAT TO DO IF YOU SMELL GAS:
• Do not try to light any appliance.
• Do not touch any electrical switch; do not use any phone in your building.
• Immediately call your gas supplier from a neighbor's phone. Follow the gas supplier's instructions.
• If you cannot reach your gas supplier, call the fire department.
- Installation and service must be performed by a qualified installer, service agency or the gas supplier.

AVERTISSEMENT : Assurez-vous de bien suivre les instructions données dans cette notice pour réduire au minimum le risque d'incendie ou d'explosion ou pour éviter tout dommage matériel, toute blessure ou la mort.

- Ne pas entreposer ni utiliser d'essence ni d'autres vapeurs ou liquides inflammables dans le voisinage de cet appareil ou de tout autre appareil.
- QUE FAIRE SI VOUS SENTEZ UNE ODEUR DE GAZ :
• Ne pas tenter d'allumer d'appareil.
• Ne touchez à aucun interrupteur. Ne pas vous servir des téléphones se trouvant dans le bâtiment où vous trouvez.
• Appelez immédiatement votre fournisseur de gaz depuis un voisin. Suivez les instructions du fournisseur.
• Si vous ne pouvez rejoindre le fournisseur de gaz, appelez le service des incendies.
- L'installation et l'entretien doivent être assurés par un installateur ou un service d'entretien qualifié ou par le fournisseur de gaz.

ACCESSORY COMPONENTS CONTINUED

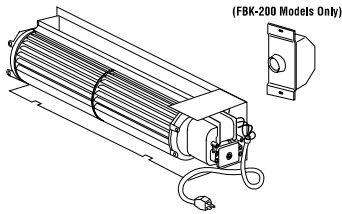

Forced Air Blower Kits		
-Single Speed	80L84	FBK-100
-Variable Speed with wall-mountable switch	80L85	FBK-200
-Variable Speed with unit-mountable switch	80L86	FBK-250

Forced Air Kit

The FBK-100 blower provides constant velocity forced air circulation. The FBK-200 assembly with variable speed, wall-mountable switch provides variable speed forced air circulation. The FBK-250 assembly with variable speed unit-mountable switch, also provides variable speed forced air circulation.

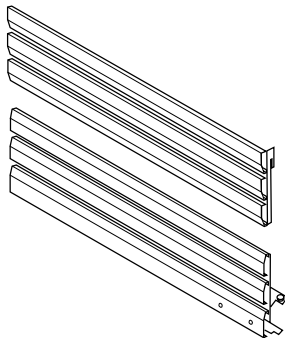

Assembled Louver Kits		
Model No.	Catalog No. Model No.	
	Polished Brass	Brushed Stainless
EDV3530	88L28	88L32
	LVR35PB-2	LVR35BS
EDV4035	88L29	88L33
	LVR40PB-2	LVR40BS
EDV4540	88L30	88L34
	LVR45PB-2	LVR45BS

These louvers are designed to replace the standard charcoal louvers that are provided with the appliance. The brass and brushed stainless louver kits include six (6) louvers.

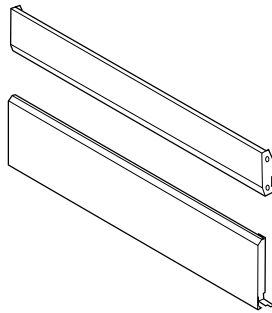

Clean Face Panel Kits	
Model No.	Catalog No. Model No.
EDV3530	88L36 RAD35C-2
	88L37 RAD40C-2
EDV4035	88L38 RAD45C-2
	88L39 RAD45C-2

Clean faced panel kits are available to convert the standard louvered fireplaces to radiant models which are more suited for finishing around the firebox opening with non-combustible materials, such as tile.

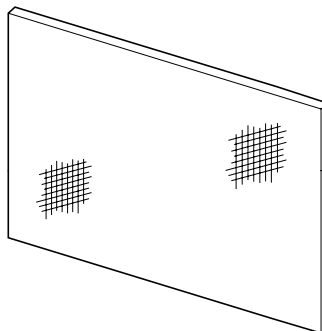

Screen Panel Kits	
Model No.	Catalog No. Model No.
EDV3530	88L52 HG35E
	96K32 HG40
EDV4035	96K33 HG45
	96K34 HG45

These screen panels can be installed on the glass enclosure panel to provide protection from the hot glass surface. The screen panel kits cannot be used in conjunction with either of the arch door kits or door frame kits.

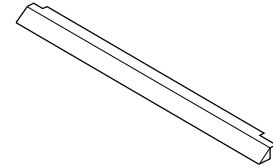

Hood Kits		
Model No.	Catalog No. Model No.	
	Polished Brass	Brushed Stainless
EDV3530	96K67 EB35PB	88L49 EB35BS
	96K68 EB40PB	88L50 EB40BS
EDV4540	96K69 EB45PB	88L51 EB45BS

These hood kits replace the standard hood that comes with these fireplaces.

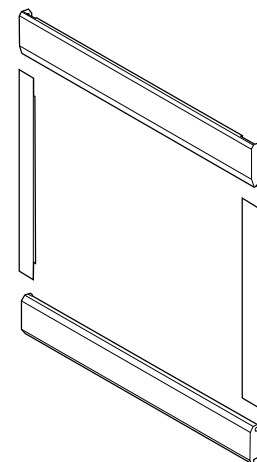

4-Piece Door Frame Kits		
Model No.	Catalog No. Model No.	
	Polished Brass	Brushed Stainless
EDV3530	88L44 DTKE35PB	90L70 DTKE35BS
	88L45 DTK40PB-2	90L71 DTK40BS
EDV4540	88L46 DTK45PB-2	90L72 DTK45BS

These kits are designed to attach directly to the front face of the fireplace at the four edges of the glass enclosure panel.

ACCESSORY COMPONENTS CONTINUED

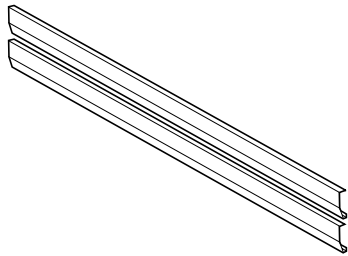

2-Piece Louver Kits		
Model No.	Catalog No. Model No.	
	Polished Brass	Brushed Stainless
EDV3530	96L05	96L09
	2LVR35PB	2LVR35BS
EDV4035	96L06	96L10
	2LVR40PB	2LVR40BS
EDV4540	96L07	96L11
	2LVR45PB	2LVR45BS

The 2-piece polished brass or brushed stainless louver kits may be used to replace either the middle charcoal louver of each louver set, or the charcoal louver in each louver set closest to the glass door.

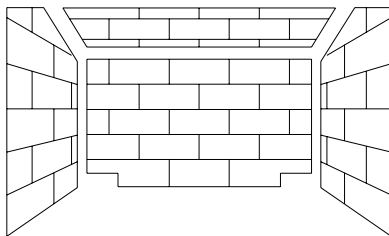

Brickaded Panel Liner Kits	
Model No.	Catalog No. Model No.
EDV3530	H0775 EBLK-35
	H0776 EBLK-40
EDV4540	H0777 EBLK-45

The brickaded panel liner kits include ceramic panels of the side walls, the rear and the baffle of the firebox. The panels have brick-like features in relief.

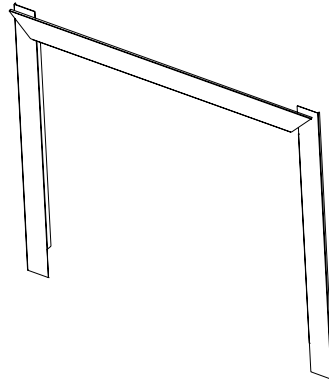

Finish Trim Kits	
Model No.	Catalog No. Model No.
EDV3530	H0454 TK35EPB3
	96K22 TK40PB3
EDV4035	96K23 TK45PB3

This kit contains brass trim pieces used to finish the gaps between the wall board and the fireplace, providing the appliance a brass perimeter highlight.



Bag of Glowing Embers 88L53 FGE

Bag of Glowing Embers

Replacement ember materials are available for use with these appliances. Order a bag of Glowing Embers, Model FGE to replace ember materials as part of the periodic maintenance of the appliance.



Touch-Up Paint (Black) Kit 90L73 TPK-B

Touch-Up Paint Kit

Repair of minor scratches and discoloration of the appliance painted surfaces may be accomplished with the touch-up paint kit.

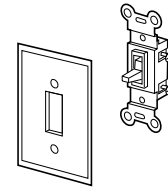

ON/OFF Wall Switch Kit 85L87 FWSK

ON/OFF Wall Switch Kit

The ON/OFF wall switch kit may be used to control the operation of the fireplace burner as an alternative to the modesty panel mounted ON-OFF switch. Install the ON/OFF wall switch in a convenient location near the fireplace.

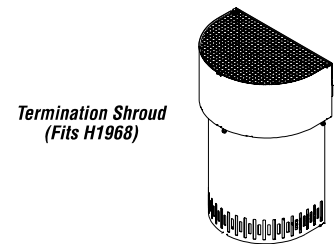

Termination Shroud (Fits H1968)

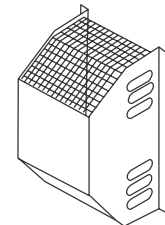

Deluxe Termination Guard (Fits 94L10)

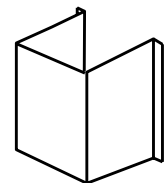

Square Termination Guard (Fits 94L10)

Termination Guard Kits

The vent termination guards may be used to cover the vent termination on the exterior of the home to minimize exposure to the hot surface of the termination.

Termination Guard Kits (all models)		
Cat. No.	Model No.	Description
H5820	4.5HTSK	Termination Shroud
87L02	SV4.5HGS	Termination Guard, Deluxe
17M52	SV4.5HGS-1	Termination Guard, Square

ACCESSORY COMPONENTS CONTINUED

Style View Doors -

Style View Doors come in 4 beautiful styles. They are easy to install and will not require hardware to attach them to the standard glass door frame. The door includes heavy duty magnet door latches and functional twin-pane doors.

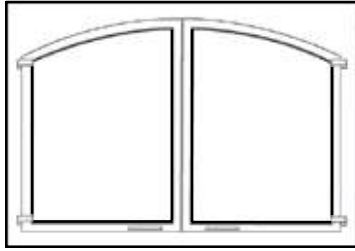

Arch Design

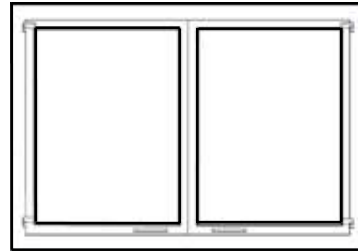

Square Design

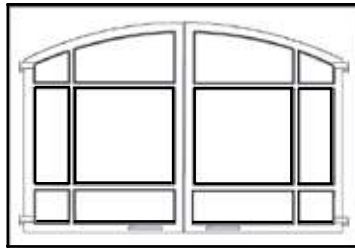

Arch Pane Design

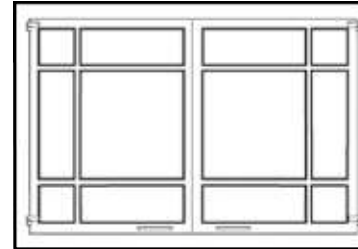

Square Pane Design

ARCH DESIGN KITS			
Cat. No.	Model	Description	Model Series
H0862	AD40C	40" Arch Doors, Black	EDV4035
H0863	AD40TI	40" Arch Doors, Textured Iron	
H0864	AD40SP	40" Arch Doors, Satin Pewter	
H0865	AD40AB	40" Arch Doors, Antique Brass	
H0866	AD45C	45" Arch Doors, Black	EDV4540
H0867	AD45TI	45" Arch Doors, Textured Iron	
H0868	AD45SP	45" Arch Doors, Satin Pewter	
H0869	AD45AB	45" Arch Doors, Antique Brass	
H0870	AD35EC	35" Elite Arch Doors, Black	EDV3530
H0871	AD35ETI	35" Elite Arch Doors, Textured Iron	
H0872	AD35ESP	35" Elite Arch Doors, Satin Pewter	
H0873	AD35EAB	35" Elite Arch Doors, Antique Brass	
ARCH PANE DESIGN KITS			
H0934	APD40C	40" Arch Pane Doors, Black	EDV4035
H0935	APD40TI	40" Arch Pane Doors, Textured Iron	
H0936	APD40SP	40" Arch Pane Doors, Satin Pewter	
H0937	APD40AB	40" Arch Pane Doors, Antique Brass	
H0938	APD45C	45" Arch Pane Doors, Black	EDV4540
H0939	APD45TI	45" Arch Pane Doors, Textured Iron	
H0940	APD45SP	45" Arch Pane Doors, Satin Pewter	
H0941	APD45AB	45" Arch Pane Doors, Antique Brass	
H0942	APD35EC	35" Elite Arch Pane Doors, Black	EDV3530
H0943	APD35ETI	35" Elite Arch Pane Doors, Textured Iron	
H0944	APD35ESP	35" Elite Arch Pane Doors, Satin Pewter	
H0945	APD35EAB	35" Elite Arch Pane Doors, Antique Brass	

SQUARE DESIGN KITS			
Cat. No.	Model	Description	Model Series
H0950	SD40C	40" Sq. Doors, Black	EDV4035
H0951	SD40TI	40" Sq. Doors, Textured Iron	
H0952	SD40SP	40" Sq. Doors, Satin Pewter	
H0953	SD40AB	40" Sq. Doors, Antique Brass	
H0954	SD45C	45" Sq. Doors, Black	EDV4540
H0955	SD45TI	45" Sq. Doors, Textured Iron	
H0956	SD45SP	45" Sq. Doors, Satin Pewter	
H0957	SD45AB	45" Sq. Doors, Antique Brass	
H0958	SD35EC	35" Elite Sq. Doors, Black	EDV3530
H0959	SD35ETI	35" Elite Sq. Doors, Textured Iron	
H0960	SD35ESP	35" Elite Sq. Doors, Satin Pewter	
H0961	SD35EAB	35" Elite Sq. Doors, Antique Brass	
SQUARE PANE DESIGN KITS			
H0966	SPD40C	40" Sq. Pane Doors, Black	EDV4035
H0967	SPD40TI	40" Sq. Pane Doors, Textured Iron	
H0968	SPD40SP	40" Sq. Pane Doors, Satin Pewter	
H0969	SPD40AB	40" Sq. Pane Doors, Antique Brass	
H0970	SPD45C	45" Sq. Pane Doors, Black	EDV4540
H0971	SPD45TI	45" Sq. Pane Doors, Textured Iron	
H0972	SPD45SP	45" Sq. Pane Doors, Satin Pewter	
H0973	SPD45AB	45" Sq. Pane Doors, Antique Brass	
H0974	SPD35EC	35" Elite Sq. Pane Doors, Black	EDV3530
H0975	SPD35ETI	35" Elite Sq. Pane Doors, Textured Iron	
H0976	SPD35ESP	35" Elite Sq. Pane Doors, Satin Pewt.	
H0977	SPD35EAB	35" Elite Sq. Pane Doors, Ant. Brass	

NOTE: DIAGRAMS & ILLUSTRATIONS ARE NOT TO SCALE.

ACCESSORY COMPONENTS CONTINUED

Style View Doors Continued -

Style View Doors also come in a Tall Arch Pane Design. Two distinctive grille kits, the “Crescents” and “Sunrise” design, are also offered separately. They are easy to install and will not require hardware to attach them to the standard glass door frame. The door includes heavy duty magnet door latches and functional twin-pane doors.

Tall Arch Pane Door

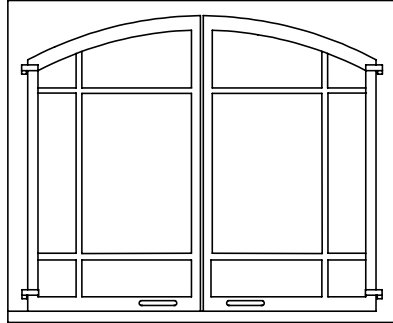

TALL ARCH PANE DOORS			
Cat. No.	Model	Description	Model Series
H3537	TAPD35EC	35" Elite Arch Pane Doors, Black	EDV3530
H3539	TAPD35ESP	35" Elite Arch Pane Doors, Satin Pewter	
H3529	TAPD40C	40" Arch Pane Doors, Black	EDV4035
H3531	TAPD40SP	40" Arch Pane Doors, Satin Pewter	
H3533	TAPD45C	45" Arch Pane Doors, Black	EDV4540
H3535	TAPD45SP	45" Arch Pane Doors, Satin Pewter	

Crescents Grille Kits

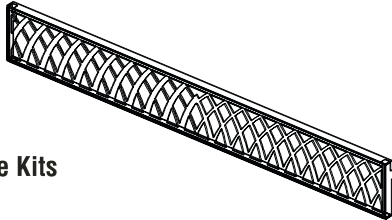

Sunrise Grille Kits

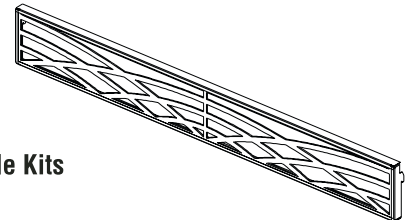

“Crescents” Grille Kits			
Cat. No.	Model	Description	Model Series
H3541	CUGK35C	35" Crescents Upper Grille Kit, Black	EDV3530
H3543	CUGK35SP	35" Crescents Upper Grille Kit, Satin Pewter	
H3545	CLGK35C	35" Crescents Lower Grille Kit, Black	
H3547	CLGK35SP	35" Crescents Lower Grille Kit, Satin Pewter	
H3549	CUGK40C	40" Crescents Upper Grille Kit, Black	EDV4035
H3551	CUGK40SP	40" Crescents Upper Grille Kit, Satin Pewter	
H3553	CLGK40C	40" Crescents Lower Grille Kit, Black	
H3555	CLGK40SP	40" Crescents Lower Grille Kit, Satin Pewter	
H3557	CUGK45C	45" Crescents Upper Grille Kit, Black	EDV4540
H3559	CUGK45SP	45" Crescents Upper Grille Kit, Satin Pewter	
H3561	CLGK45C	45" Crescents Lower Grille Kit, Black	
H3563	CLGK45SP	45" Crescents Lower Grille Kit, Satin Pewter	

“Sunrise” Grille Kits			
Cat. No.	Model	Description	Model Series
H3565	SUGK35C	35" Sunrise Upper Grille Kit, Black	EDV3530
H3567	SUGK35SP	35" Sunrise Upper Grille Kit, Satin Pewter	
H3569	SLGK35C	35" Sunrise Lower Grille Kit, Black	
H3571	SLGK35SP	35" Sunrise Lower Grille Kit, Satin Pewter	
H3573	SUGK40C	40" Sunrise Upper Grille Kit, Black	EDV4035
H3575	SUGK40SP	40" Sunrise Upper Grille Kit, Satin Pewter	
H3577	SLGK40C	40" Sunrise Lower Grille Kit, Black	
H3579	SLGK40SP	40" Sunrise Lower Grille Kit, Satin Pewter	
H3581	SUGK45C	45" Sunrise Upper Grille Kit, Black	EDV4540
H3583	SUGK45SP	45" Sunrise Upper Grille Kit, Satin Pewter	
H3585	SLGK45C	45" Sunrise Lower Grille Kit, Black	
H3587	SLGK45SP	45" Sunrise Lower Grille Kit, Satin Pewter	

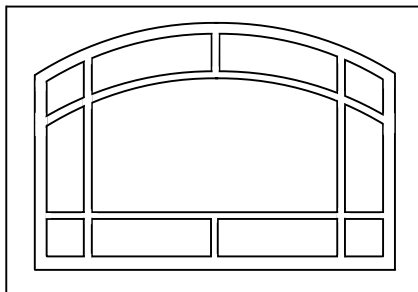

Arch Screen Panel Kit
40" Decorative Arch Screen Panel Kit - Textured Iron

Model No.
DASPK40TI

Catalog No.
H3594

This screen panel kit can be installed on the glass enclosure panel to prevent direct contact with the hot glass surface. The panel kit adds a new design choice with a handsome textured iron finish. The screen panel kit cannot be used in conjunction with either of the arch door kits or door frame kits.

REPLACEMENT PARTS LIST

Item No.	Description	EDV3530		EDV4035		EDV4540	
		Part No.	Qty.	Part No.	Qty.	Part No.	Qty.
1	Hood	H3895	1	H3896	1	H3897	1
2	Louver Assembly, Top	H3726	1	H2727	1	H3728	1
3	Louver Assembly, Bottom	H3726	1	H2727	1	H3728	1
4	Enclosure, Glass Front (Complete)	91L18	1	H3724	1	91L16	1
5	Bustle, Top	H4964	1	H3741	1	H3742	1
6	Bustle, Bottom	91L25	1	H3729	1	H3730	1
7	Nameplate (Brand)	12L15	1	12L15	1	12L15	1
8	Latch	69L21	2	69L21	2	69L21	2
9	Catch, Door, Magnetic	69L31	1	69L31	1	69L31	1
10	Log Set (Complete)	55M02	1	55M03	1	55M03	1
11	Burner Assembly	55M29	1	55M30	1	55M30	1
12	Grate Assembly	H4990	1	H4991	1	H4991	1
13	Venturi/Air Shutter	H3707	1	H3707	1	H3707	1
14	Orifice, Main Burner - Nat. Gas	69L96	1	18L40	1	99K77	1
14	Orifice, Main Burner - LP Gas	39L10	1	37G00	1	H0922	1
15	Ceramic Panel Floor (Complete)	55M46	1	55M47	1	55M48	1
16	Bag of Rockwool	88L53	1	88L53	1	88L53	1
17	ON/OFF Control Switch	80L41	1	80L41	1	80L41	1
18a	Modesty Panel, Millivolt	H3382	1	H3382	1	H3384	1
18b	Modesty Panel, Electronic	H3381	1	H3381	1	H3383	1
19	Gasket - Venturi Tube Mounting	43K85	1	43K85	1	43K85	1
20	Gas Line Flexible Connector	93L32	1	93L32	1	93L32	1
21	Magnet	H3699	1	H3699	1	H3699	1

Gas Controls - SIT Millivolt

Item No.	Description	Natural Gas		Propane Gas	
		Part No.	Qty.	Part No.	Qty.
30	Gas Valve, SIT	43K07	1	88J53	1
31	Piezo Igniter	10K86	1	10K86	1
32	Pilot Assembly	69L17	1	69L18	1
33	Pilot Generator	60J79	1	60J79	1
34	Thermocouple	74L57	1	74L57	1
35	Pilot Tube	74L56	1	74L56	1
36	Electrode And Cable	74L58	1	74L58	1

Gas Controls - Honeywell Electronic

Item No.	Description	Natural Gas	
		Part No.	Qty.
40	Gas Valve, Honeywell	62L18	1
41	Pilot Assembly	62L14	1
42	Transformer	42J32	1
43	Ignitor Assembly (Kit)	87L54	1

Contact an Authorized Lennox Hearth Products dealer to obtain any of these parts. Never use substitute materials. Use of non-approved parts can result in poor performance and safety hazards.

WARNING

Failure to position the parts in accordance with these diagrams or failure to use only parts specifically approved with this appliance may result in property damage or personal injury.

AVERTISSEMENT

Risque de dommages ou de blessures si les pièces ne sont pas installées conformément à ces schémas et ou si des pièces autres que celles spécifiquement approuvées avec cet appareil sont utilisées.

REPLACEMENT PARTS

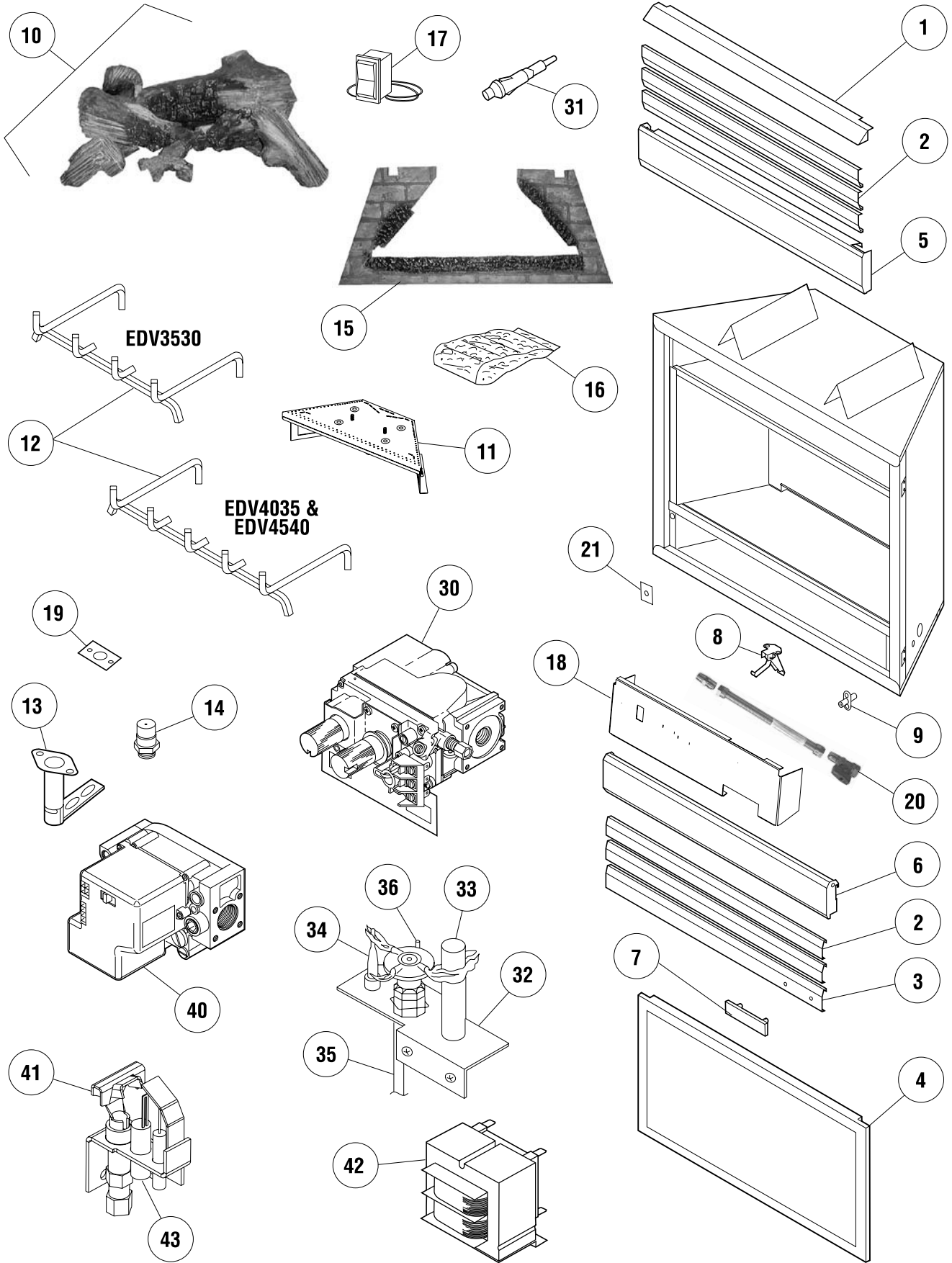

NOTE: DIAGRAMS & ILLUSTRATIONS ARE NOT TO SCALE.