



P/N 875025M Rev. E 01/2011

This manual is part of a set of two supporting this product. Refer to P/N 850024M for Installation Instructions.
Ce manuel est disponible en français, simplement en faire la demande. Numéro de la pièce 875025CF.

WHAT'S INSIDE

Table of Contents	2
Safety and Your Fireplace	2
FREE Safety Guard Offer (Protects Against Burns)	2
Important Safety Information	4
Attaching the Safety-in-Operation Warnings	5
[EN FRANÇAIS] L'information de sûreté importante	3-4
Apposition des mises en garde relatives à la sécurité d'utilisation ...	5
[EN ESPAÑOL] Información importante de seguridad	3-4
Colocación de advertencias de seguridad en operación	5

CARE AND OPERATION INSTRUCTIONS

MPD35 Direct-Vent Gas Fireplaces

MERIT™ Plus SERIES

MODELS

MILLIVOLT:		ELECTRONIC:
MPD35ST-NM-B	MPD35PF-NM-B	MPD35ST-NE-B
MPD35ST-PM-B	MPD35PF-PM-B	MPD35PF-NE-B



OTL Report No. 116-F-28-5



INSTALLER: Leave this manual with the appliance.
CONSUMER: Retain this manual for future reference.
INSTALLATEUR : Laissez cette notice avec l'appareil.
CONSOMMATEUR : Conservez cette notice pour consultation ultérieure.



! WARNING / AVERTISSEMENT / AVISO

- HOT GLASS WILL CAUSE BURNS.
- DO NOT TOUCH GLASS UNTIL COOLED.
- NEVER ALLOW CHILDREN TO TOUCH GLASS.



- UNE SURFACE VITRÉE CHAUDE PEUT CAUSER DES BRÛLURES.
- LAISSER REFROIDIR LA SURFACE VITRÉE AVANT D'Y TOUCHER.
- NE PERMETTEZ JAMAIS À UN ENFANT DE TOUCHER LA SURFACE VITRÉE.

- EL VIDRIO CALIENTE CAUSARÁ QUEMADURAS.
- USTED DEBE NUNCA TOCAR EL VIDRIO CALIENTE.
- LOS NIÑOS DEBEN NUNCA TOCAR EL VIDRIO.

WARNING: If the information in these instructions is not followed exactly, a fire or explosion may result, causing property damage, personal injury, or death.

- Do not store or use gasoline or other flammable vapors and liquids in the vicinity of this or any other appliance.
- **WHAT TO DO IF YOU SMELL GAS:**
 - Do not try to light any appliance.
 - Do not touch any electrical switch; do not use any phone in your building.
 - Immediately call your gas supplier from a neighbor's phone. Follow the gas supplier's instructions.
 - If you cannot reach your gas supplier, call the fire department.
- Installation and service must be performed by a qualified installer, service agency or the gas supplier.

AVERTISSEMENT : Assurez-vous de bien suivre les instructions données dans cette notice pour réduire au minimum le risque d'incendie ou d'explosion ou pour éviter tout dommage matériel, toute blessure ou la mort.

- Ne pas entreposer ni utiliser d'essence ni d'autres vapeurs ou liquides inflammables dans le voisinage de cet appareil ou de tout autre appareil.
- **QUE FAIRE SI VOUS SENTEZ UNE ODEUR DE GAZ :**
 - Ne pas tenter d'allumer d'appareil.
 - Ne touchez à aucun interrupteur. Ne pas vous servir des téléphones se trouvant dans le bâtiment où vous trouvez.
 - Appelez immédiatement votre fournisseur de gaz depuis un voisin. Suivez les instructions du fournisseur.
 - Si vous ne pouvez rejoindre le fournisseur de gaz, appelez le service des incendies.
- L'installation et l'entretien doivent être assurés par un installateur ou un service d'entretien qualifié ou par le fournisseur de gaz.

ACCESSORY COMPONENTS

Product Reference Information			
Cat. No.	Model	Ship. Weight	Ship. Volume
H3201	MPD35ST-NM-B	220 lbs	46W x 26D x 43H (30 cu.ft.)
H6945	MPD35PF-NM-B	225 lbs	46W x 26D x 43H (30 cu.ft.)
H3202	MPD35ST-PM-B	220 lbs	46W x 26D x 43H (30 cu.ft.)
H6946	MPD35PF-PM-B	225 lbs	46W x 26D x 43H (30 cu.ft.)
H3203	MPD35ST-NE-B	220 lbs	46W x 26D x 43H (30 cu.ft.)
H6947	MPD35PF-NE-B	225 lbs	46W x 26D x 43H (30 cu.ft.)



Wall Thermostat, Millivolt		
Cat. No.	Model No.	Description
H4635	DWTK	Wall Thermostat Kit, White

Digital Wall Thermostat

The wall thermostat kit provides temperature control for optimum comfort.

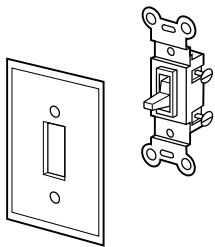

White Wall Switch Kit		
Cat. No.	Model No.	Description
85L87	FWSK	OFF/ON Wall Switch Kit

OFF/ON Wall Switch Kit

The OFF/ON wall switch kit may be used to control the operation of the fireplace burner. Install the OFF/ON wall switch in a convenient location near the fireplace.



Remote Control Kit, Standard		
Cat. No.	Model No.	Description
H0249	RCL	Remote Control System (Standard)

(ref. Form # 750,127M)

Standard Remote Control System

The Model RCL (Standard) Remote Control System, features a simplistic OFF/ON control function for the fireplace. This model includes a hand-held transmitter, a remote receiver with wall-mount cover plate and all hardware required to install the unit. The remote receiver can be wall or hearth mounted.

The transmitter has ON and OFF functions that are activated by pressing either button on the face of the transmitter. When a button on the transmitter is pressed, a signal light illuminates briefly to verify that a signal has been sent.

The Model RCL is designed to operate with all millivolt ignition systems, as well as electronic ignition systems. It may be installed with use for either natural gas or propane gas appliances. The RCL offers ease of installation and allows you to execute on-off commands to the fireplace effortlessly with one simple motion.

The Model RCL comes complete with detailed operating instructions.



Remote Control Kit, Deluxe		
Cat. No.	Model No.	Description
H0251	RCL-STAT	Remote Control System (Deluxe)

(ref. Form # 750,129M)

Deluxe Remote Control System

The Model RCL-T (Deluxe) Remote Control System has all of the features of the standard system along with an added easy to read LCD screen which presents access to many enhancements, including; battery power level indicator, timer, mode of operation, thermostatic display including room temperature in either metric of English units, flame indicator and clock. Fully programmable, the Model RCL-T allows for virtual command over nearly all operational and temperature variables, using the hand held remote control transmitter.

The Model RCL-T (Deluxe) remote control system is installed in the same manner as the standard system, may be operated with electronic and millivolt systems with either natural gas or propane gas. The RCL-T comes complete with detailed operating instructions.

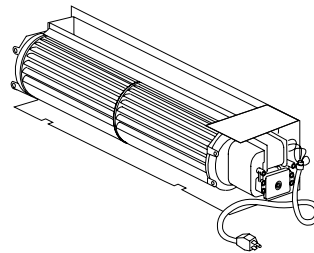

Forced Air Kit

The FBK-100 blower provides constant velocity forced air circulation. The FBK-200 assembly with variable speed, wall-mountable switch provides variable speed forced air circulation. The FBK-250 assembly with variable speed unit-mountable switch, also provides variable speed forced air circulation.

Forced Air Blower Kits		
Cat. No.	Model No.	Description
80L84	FBK-100	Blower, Standard (single speed)
80L85	FBK-200	Blower, Variable Speed (w/wall-mounted switch)
80L86	FBK-250	Blower, Variable Speed (w/unit-mounted switch)
94L89	FBK-100-36	Blower, Standard, 36 Pack
94L90	FBK-200-36	Blower Kit - Variable Speed with Wall Switch 36 Pack
H0543	FBK-250-36	Blower Kit - Variable Speed with Thermo Snap Switch 36 Pack

(ref. Form # 750,028M & 750,029M)

ACCESSORY COMPONENTS

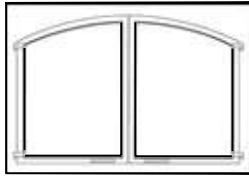

Arch Design

Arch Pane Design

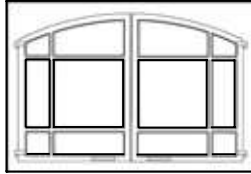

Square Design



Square Pane Design

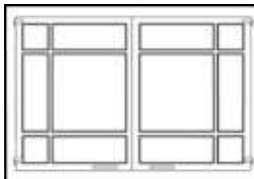

Style View Screen Doors -

These Style View screen doors come in 4 beautiful styles. They are easy to install and will not require hardware to attach them to the standard glass door frame. The screens prevent direct contact with the hot glass surface. The door includes heavy duty magnet door latches and functional twin-pane screen doors.

Arch Pane Design Kits		
Cat. No.	Model	Description
H0930	APD35C	35" Arch Pane Doors
H0931	APD35TI	35" Arch Pane Doors, Text. Iron
H0932	APD35SP	35" Arch Pane Doors, Satin Pew.
H0933	APD35AB	35" Arch Pane Doors, Ant. Brass

Arch Design Kits		
Cat. No.	Model	Description
H0858	AD35C	35" Arch Doors
H0859	AD35TI	35" Arch Doors, Textured Iron
H0860	AD35SP	35" Arch Doors, Satin Pewter
H0861	AD35AB	35" Arch Doors, Antique Brass

Square Design Kits		
Cat. No.	Model	Description
H0946	SD35C	35" Sq. Doors
H0947	SD35TI	35" Sq. Doors, Textured Iron
H0948	SD35SP	35" Sq. Doors, Satin Pewter
H0949	SD35AB	35" Sq. Doors, Antique Brass

Square Pane Design Kits		
Cat. No.	Model	Description
H0962	SPD35C	35" Sq. Pane Doors
H0963	SPD35TI	35" Sq. Pane Doors, Text. Iron
H0964	SPD35SP	35" Sq. Pane Doors, Satin Pew.
H0965	SPD35AB	35" Sq. Pane Doors, Ant. Brass

(ref. Form # 775,169M)

Note: Door & Trim Kits are for 1 side only. If set is desired, order 2 kits.

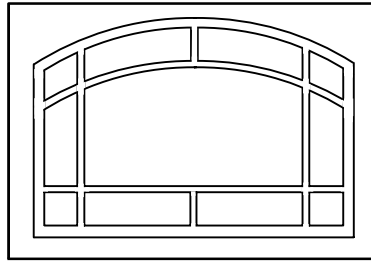

Decorative Arch Screen Panel Kit

This easy to install optional screen installs over the standard glass enclosure panel to provide protection from direct contact with the hot glass surface. These screen panels cannot be used in conjunction with the arch door kits or door frame kits.

Decorative Arch Screen Panel Kit		
Cat. No.	Model	Description
H3593	DASPK35TI	35" Dec. Arch Screen Panel

(ref. Form # 750,199M)

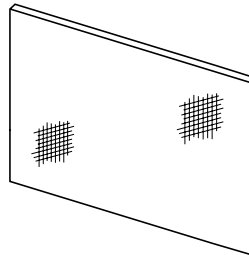

*Screen Heat Guard Kit		
Cat. No.	Model No.	Description
26M48	HG35M	35" Screen Heat Guard Kit
H7018	HG22M	22" Screen Heat Guard Kit

* Order 2 for set if desired.

(ref. Form # 750,101M)

Screen Heat Guard Kit

This easy to install optional screen heat guard installs over the standard glass enclosure panel to prevent contact with the hot glass surface. These screen heat guard panels cannot be used in conjunction with the arch door kits or door frame kits. Order 2 if a set is desired (for front face and rear face glass surfaces).

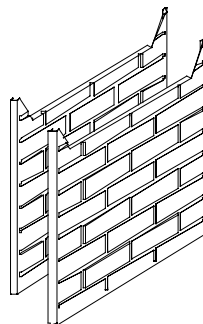

Brickaded Wall Liner Kits		
Cat. No.	Model No.	Description
H3207	MBLK-35ST	Interior Brick Liner Kit

(ref. Form # 750,160M)

Brickaded Panel Liner Kit

The brickaded liner kits include ceramic panels as shown here. The panels have brick-like features in relief.

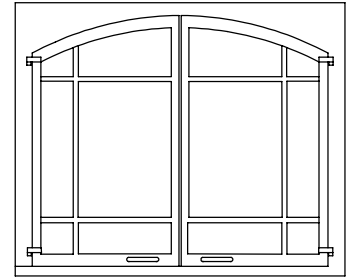

Tall Style View Doors

These decorative screen doors are offered in four attractive finishes and fit on the face of the appliance over the glass doorframe to prevent direct contact with the hot glass surface. These doors replace the bottom louver assembly and cover the control compartment which elongates the appearance of the height of the fireplace face.

Style View Tall Arch 35" Pane Screen Door Kits		
Cat. No.	Model	Description
H3525	TAPD35C	Arch Pane, Black
H3527	TAPD35SP	Arch Pane, Satin Pewter

(ref. Form # 750,200M)

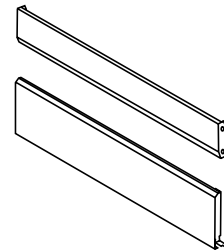

Clean Face Charcoal Radiant Panel Kits		
Cat. No.	Model No.	Description
88L36	RAD35C-2	Clean Face Panel Kit
H7019	RAD22C-2	Clean Face Panel Kit

(ref. Form # 504,223M)

Clean Face Panel Kits

Clean faced panel kits are available to convert the standard louvered fireplaces to radiant models which are more suited for finishing around the firebox opening with non-combustible materials, such as tile.

ACCESSORY COMPONENTS

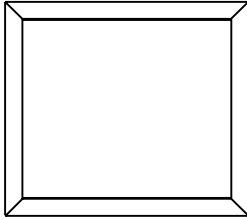

4 Piece Trim Kit		
Cat. No.	Model No.	Description
96K17	TK35PB4	35" 4 Piece Finish Trim Kit, Polished Brass

(ref. Form # ii-9299)

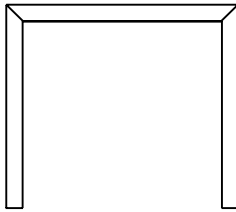

3 Piece Trim Kit		
Cat. No.	Model No.	Description
96K21	TK35PB3	35" 3 Piece Finish Trim Kit, Polished Brass
H4821	TK35C3	35" 3 Piece Finish Trim Kit, Black

(ref. Form # 750,147M)

Polished Brass Trim Kit

This kit contains brass trim pieces used to finish the gaps between the wall board and the fireplace, providing the appliance a brass perimeter highlight. This kit contains the trim pieces and these instructions.

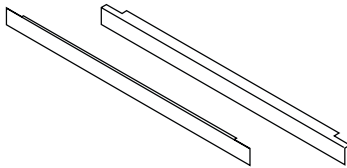

2 Piece Trim Kit		
Cat. No.	Model No.	Description
26M88	2DFK35PB	35" Door Trim Kit, Polished Brass (2 Piece, Top and Bottom)
H7020	2DFK22PB	22" Door Trim Kit, Polished Brass (2 Piece, Top and Bottom)
26M91	2DFK35BS	35" Door Trim Kit, Brushed Stainless (2 Piece, Top and Bottom)
H7021	2DFK22BS	22" Door Trim Kit, Brushed Stainless (2 Piece, Top and Bottom)

(ref. Form # 750,098M)

2-Piece Door Frame Kits

These kits are designed to attach directly to the front face of the appliance at the glass enclosure panel's top and bottom edges.

Note: Door & Trim Kits are for 1 side only. If set is desired, order 2 kits.

Sunrise Style (upper grille shown)



Crescent Style (lower grille shown)



Cat. No.#	Model	Description	Model Series
H3565	SUGK35C	35" Black	UPPER GRILLE KITS SUNRISE
H3567	SUGK35SP	35" Satin Pewter	

Cat. No.	Model	Description	Model Series
H3541	CUGK35C	35" Black	UPPER GRILLE KITS CRESCENTS
H3543	CUGK35SP	35" Satin Pewter	

Cat. No.	Model	Description	Model Series
H3569	SLGK35C	35" Black	LOWER GRILLE KITS SUNRISE
H3571	SLGK35SP	35" Satin Pewter	

Cat. No.	Model	Description	Model Series
H3545	CLGK35C	35" Black	LOWER GRILLE KITS CRESCENTS
H3547	CLGK35SP	35" Satin Pewter	

(ref. Form # 750,202M)

Decorative Grille Kits

These decorative grilles are offered in two attractive finishes and fit on the face of the appliance in place of the standard louvers.

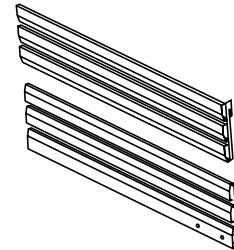
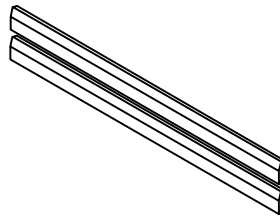

2-Piece Louver Kits		
Cat. No.	Model No.	Description
96L05	2LVR35PB	2 Pc. Louver Kit, Polished Brass
H7022	2LVR22PB	2 Pc. Louver Kit, Polished Brass
96L09	2LVR35BS	2 Pc. Louver Kit, Brushed Stainless
H7023	2LVR22BS	2 Pc. Louver Kit, Brushed Stainless

(ref. Form # 504,224M)

2-Piece Polished Brass and Brushed Stainless Louvers Kits

These louvers are designed to replace either the middle charcoal louver of each set or the charcoal louver in each set closest to the glass door. These kits include two narrow louvers. They provide a touch of elegance to these appliances. These kits can be retrofitted to previously installed appliances.

35" Assembled Louver Kits		
Cat. No.	Model No.	Description
88L28	LVR35PB-2	Louver Kit, Polished Brass
H7024	LVR22PB-2	Louver Kit, Polished Brass
88L32	LVR35BS-2	Louver Kit, Brushed Stainless
H7025	LVR22BS-2	Louver Kit, Brushed Stainless

(ref. Form # 750,119M)

Polished Brass & Brushed Stainless Louvers Kits

Decorative louvers are available for use with all Multi-Open Series appliances. These kits include a top 3-piece assembly and a bottom 3-piece assembly. They provide a touch of elegance to any Multi-Open Series appliance. These kits can be retrofitted to previously installed appliances.

ACCESSORY COMPONENTS



Touch-Up Paint Kits		
Cat. No.	Model No.	Description
90L73	TPK-B	Touch-Up Paint (Black)
98K67	TPK-T	Touch-Up Paint (Tan)

(TPK-C ref. Form # 504,216M)

Touch-Up Paint Kit

Repair of minor scratches and discoloration of the appliance charcoal painted surfaces may be accomplished with the touch-up paint kit.

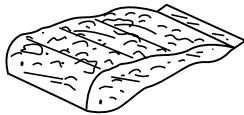

Decorative Firebox Accessories		
Cat. No.	Model No.	Description
88L53	FGE	Bag of Glowing Embers (1 oz. rockwool)
80L42	FDVS	Bag of Decorative Volcanic Stone

(FDVS ref. Form #750,010M)

Bag of Glowing Embers Bag of Volcanic Stone

Replacement ember materials or volcanic stone are available for use with these appliances. Order kits as part of the periodic maintenance of the appliance.

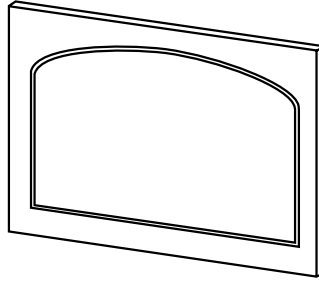

* 35" Arch Door Kits		
Cat. No.	Model No.	Description
26M43	ADK35CMPB	Arch Door, Polished Brass
H7026	ADK22CMPB	Arch Door, Polished Brass
26M44	ADK35CMBS	Arch Door, Brushed Stainless
H7027	ADK22CMBS	Arch Door, Brushed Stainless

* Order 2 for set if desired.

(ref. Form # 750,021M)

Arch Door Kits

Two types of arch door kits are available for the Multi-Open Series. Both types of kits are easy to install and do not require hardware to attach them to the standard door frame. These kits can be retrofitted to previously installed Multi-Open Series appliances. The decorative arch kits can not be used in conjunction with the screen panel kit.

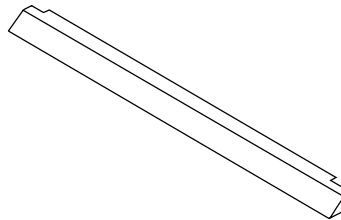

*Eyebrow Hood Kits		
Cat. No.	Model No.	Description
96K67	EB35PB	Hood Kit, Polished Brass
H7028	EB22PB	Hood Kit, Polished Brass
88L49	EB35BS	Hood Kit, Brushed Stainless
H7029	EB22BS	Hood Kit, Brushed Stainless

* These hood kits replace the standard hood that comes with these fireplaces.

(ref. Form #504,142M)

Polished Brass & Brushed Stainless Hood Kits

Attractive hoods are available in two styles to be used on the Multi-Open Series appliances. These hoods are designed to be fitted to the glass viewing sides of the appliance. In addition to providing an aesthetically pleasing appearance to your appliance installation, the hood reduces heat effects to decorative mantles and finish materials located above the fireplace opening. The hood kit replaces the standard hood that comes with these appliances and snaps into place. These kits can be retrofitted to previously installed appliances.

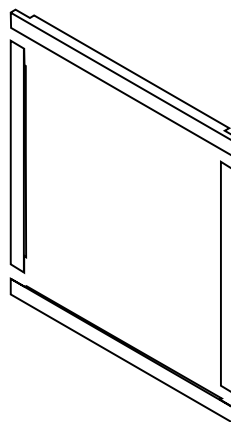

4 Piece Door Trim Kits		
Cat. No.	Model No.	Description
26M82	4DFK35PB	Door Trim, Polished Brass
H7030	4DFK22PB	Door Trim, Polished Brass
26M85	4DFK35BS	Door Trim, Brushed Stainless
H7031	4DFK22BS	Door Trim, Brushed Stainless

(ref. Form # 750,098M)

Door Frame Kits

A decorative door frame kit is available for use with these appliances. It is designed to attach directly to the front face of the appliance at the four edges of the glass enclosure panel resulting in the appearance of a picture frame.

REPLACEMENT PARTS LIST - MPD35ST/PF

Item	Part/Cat.No.	Qty	Description	Where Used
SIT Millivolt Only				
1	H3357	1	Gas Train Assembly, NG, MV	MPD35ST-NM
1	H3355	1	Gas Train Assembly, LP, MV	MPD35ST-PM
Honeywell Electronic Only				
2	H3356	1	Gas Train Assembly, NG, Electr.	MPD35ST-NE
3	42J32	1	Transformer	MPD35ST-NE & MPD35ST-PE
Misc. Replacement Parts				
4	H3351	2	Brickaded Side Panels	All
5	H3352	1	Burner, Pan	All
6	H3353	1	* Electrical kit	All
7	97K51	2	Eyebrow Hood	MPD35ST-NE & MPD35ST-PE
7A	H7032	1	Eyebrow Hood	MPD35PF-NE & MPD35PF-PE
8	93L32	1	Flex Line Gas Connector, FFGC	All
9	H4864	2	Glass Enclosure Assembly 35"	MPD35ST-NE & MPD35ST-PE
9A	H7033	1	Glass Enclosure Assembly 22"	MPD35PF-NE & MPD35PF-PE
10	H3696		Vermiculite, Bag of	All
11	H3358	1	Grate Assembly	All
12	69L21	4	Latch, Glass Enclosure Panel	All
13	H3354	1	Firebox Sub-Floor	All

Note: Ordering information for Volcanic Stone, Glowing Embers and Touch-up Paint can be found on **Page 21**.

Contact an Authorized Lennox Hearth Products dealer to obtain any of these parts. Never use substitute materials. Use of non-approved parts can result in poor performance and safety hazards.

WARNING

Failure to position the parts in accordance with these diagrams or failure to use only parts specifically approved with this appliance may result in property damage or personal injury.

AVERTISSEMENT

Risque de dommages ou de blessures si les pièces ne sont pas installées conformément à ces schémas et ou si des pièces autres que celles spécifiquement approuvées avec cet appareil sont utilisées.

Item	Part/Cat. No.	Qty	Description	Where Used
Misc. Replacement Parts				
14	H3210	1	Log Set	All
15	H3726	2	Louver Assembly, Upper (35")	All
15A	H7034	1	Louver Assembly, Upper (22")	All
16	H3734	1	Louver Assembly, Lower, (valve access side)	All
17	H3359	1	Louver Assembly, Lower, (35")	All
17A	H7035	1	Louver Assembly, Lower, (22")	All
18	69L31	2	Magnet, Latch, Spring-Loaded	All
19	94326	2	Magnet	All
20	H3740	8	Nailing Flange	All
21	12L15	2	Nameplate, Lennox	All
22	24M10	1	Orifice, Burner, NG, #37 (.104")	MPD35ST-NM & MPD35ST-NE
22	42M79	1	Orifice, Burner, LP, 1.55mm (.061")	MPD35ST-PM & MPD35ST-PE
23	91K94	1	Piezo Igniter (w/wire)	MPD35ST-NM & MPD35ST-PM
24	27K30	1	OFF/ON Switch, Rocker	All
25	H3363		Vent Restrictor	All

* Electrical Outlet Kit consists of a junction box, 2 screws, a receptacle outlet, an OFF/ON rocker switch and a snap bushing. Note: All the components in the electrical kit will Not be used by every model.

REPLACEMENT PARTS - MPD35ST/PF

14 Complete Log Set Available Only

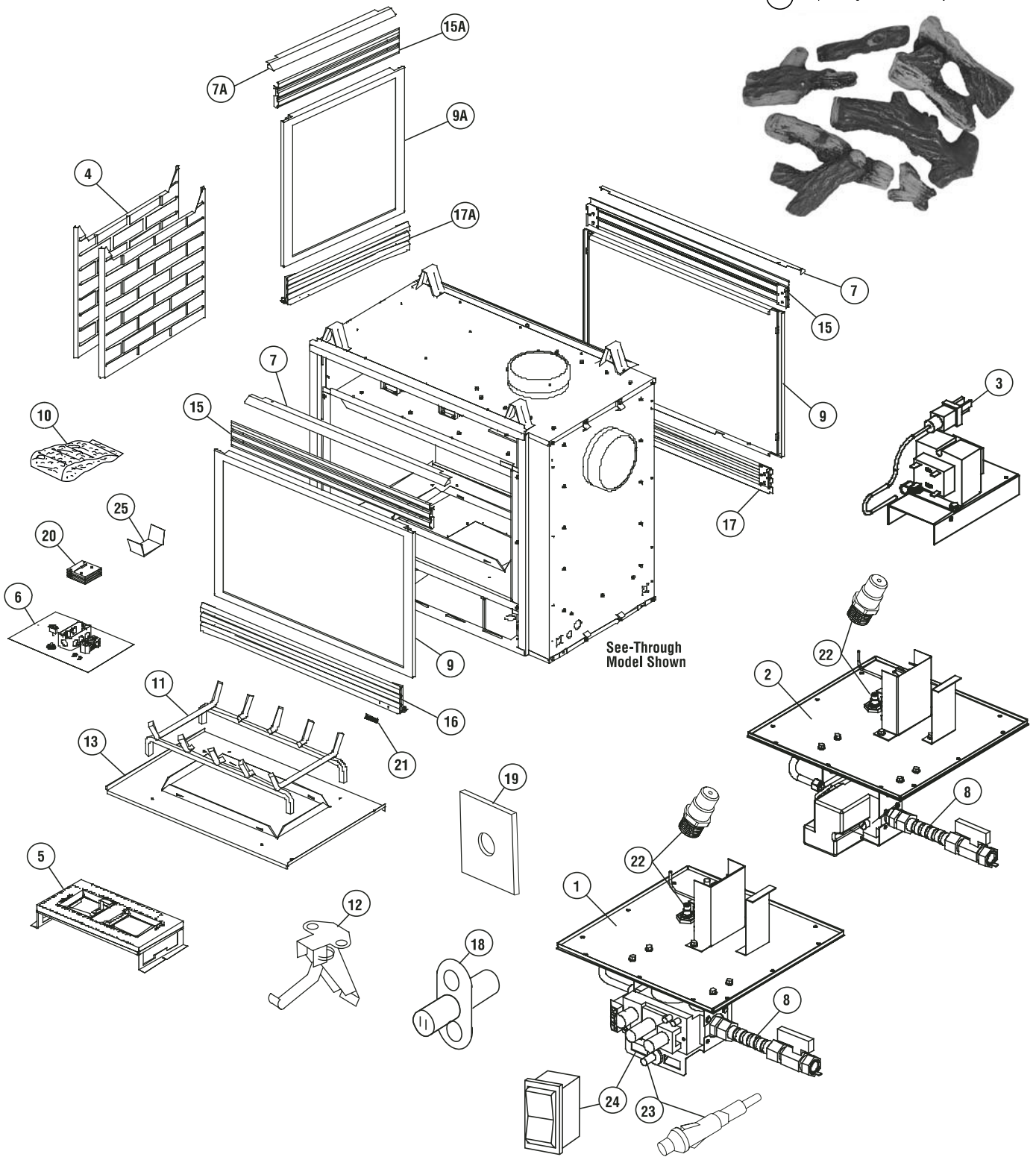

NOTE: DIAGRAMS & ILLUSTRATIONS ARE NOT TO SCALE.