



HEARTH PRODUCTS

P/N 875022M Rev. F 01/2011

This manual is part of a set of two supporting this product. Refer to P/N 850018M for Installation Instructions.

Ce manuel est disponible en français, simplement en faire la demande. Numéro de la pièce 875022CF.

WHAT'S INSIDE

|   |     |
|---|-----|
| Table of Contents .....   | 2   |
| <b>Safety and Your Fireplace</b> .....                                  | 2   |
| FREE Safety Guard Offer (Protects Against Burns) .....                  | 2   |
| <b>Important Safety Information</b> .....                               | 4   |
| <b>Attaching the Safety-in-Operation Warnings</b> .....                 | 5   |
| [EN FRANÇAIS] L'information de sûreté importante .....                  | 3-4 |
| Apposition des mises en garde relatives à la sécurité d'utilisation ... | 5   |
| [EN ESPAÑOL] Información importante de seguridad .....                  | 3-4 |
| Colocación de advertencias de seguridad en operación .....              | 5   |

CARE AND OPERATION INSTRUCTIONS

EDV Direct-Vent Gas Fireplaces

ELITE™ SERIES

MODELS

| MILLIVOLT: |           | ELECTRONIC: |           |
|------------|-----------|-------------|-----------|
| EDVSTNM-B  | EDVCRNM-B | EDVSTNE-B   | EDVCRNE-B |
| EDVSTPM-B  | EDVCRPM-B | EDVPFNE-B   | EDVCLNE-B |
| EDVPFNM-B  | EDVCLNM-B |             |           |
| EDVPFPM-B  | EDVCLPM-B |             |           |



OTL Report No. 116-F-04-5



**INSTALLER:** Leave this manual with the appliance.  
**CONSUMER:** Retain this manual for future reference.  
**INSTALLATEUR :** Laissez cette notice avec l'appareil.  
**CONSOMMATEUR :** Conservez cette notice pour consultation ultérieure.



! WARNING / AVERTISSEMENT / AVISO

- HOT GLASS WILL CAUSE BURNS.
- DO NOT TOUCH GLASS UNTIL COOLED.
- NEVER ALLOW CHILDREN TO TOUCH GLASS.



- UNE SURFACE VITRÉE CHAUDE PEUT CAUSER DES BRÛLURES.
- LAISSER REFROIDIR LA SURFACE VITRÉE AVANT D'Y TOUCHER.
- NE PERMETTEZ JAMAIS À UN ENFANT DE TOUCHER LA SURFACE VITRÉE.

- EL VIDRIO CALIENTE CAUSARÁ QUEMADURAS.
- USTED DEBE NUNCA TOCAR EL VIDRIO CALIENTE.
- LOS NIÑOS DEBEN NUNCA TOCAR EL VIDRIO.

**WARNING:** If the information in these instructions is not followed exactly, a fire or explosion may result, causing property damage, personal injury, or death.

- Do not store or use gasoline or other flammable vapors and liquids in the vicinity of this or any other appliance.
- **WHAT TO DO IF YOU SMELL GAS:**
  - Do not try to light any appliance.
  - Do not touch any electrical switch; do not use any phone in your building.
  - Immediately call your gas supplier from a neighbor's phone. Follow the gas supplier's instructions.
  - If you cannot reach your gas supplier, call the fire department.
- Installation and service must be performed by a qualified installer, service agency or the gas supplier.

**AVERTISSEMENT :** Assurez-vous de bien suivre les instructions données dans cette notice pour réduire au minimum le risque d'incendie ou d'explosion ou pour éviter tout dommage matériel, toute blessure ou la mort.

- Ne pas entreposer ni utiliser d'essence ni d'autres vapeurs ou liquides inflammables dans le voisinage de cet appareil ou de tout autre appareil.
- **QUE FAIRE SI VOUS SENTEZ UNE ODEUR DE GAZ :**
  - Ne pas tenter d'allumer d'appareil.
  - Ne touchez à aucun interrupteur. Ne pas vous servir des téléphones se trouvant dans le bâtiment où vous trouvez.
  - Appelez immédiatement votre fournisseur de gaz depuis un voisin. Suivez les instructions du fournisseur.
  - Si vous ne pouvez rejoindre le fournisseur de gaz, appelez le service des incendies.
- L'installation et l'entretien doivent être assurés par un installateur ou un service d'entretien qualifié ou par le fournisseur de gaz.

## EDVPF, EDVST, EDVCL AND EDVCR LOG PLACEMENT

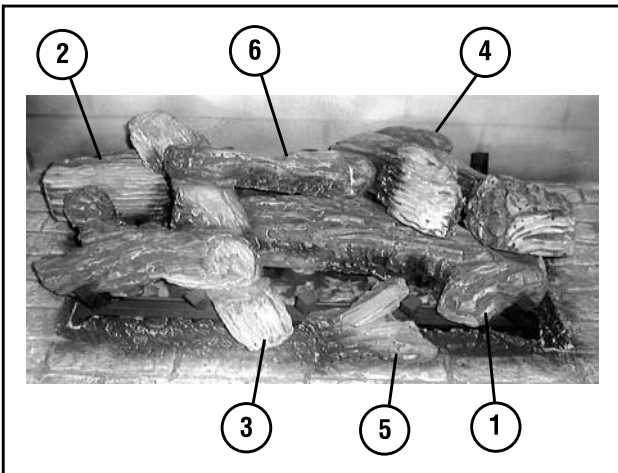

| Log Number | Description       | Part Number |
|------------|-------------------|-------------|
| 1          | Log, Corner       | 55M18       |
| 2          | Log, Rear/Left    | 55M19       |
| 3          | Log, Front/Left   | 55M20       |
| 4          | Log, Rear/Right   | 55M21       |
| 5          | Log, Front/Center | 55M22       |
| 6          | Log, Center/Top   | 55M23       |

**Catalog Number for the entire log set: 55M04**

### STEP 1

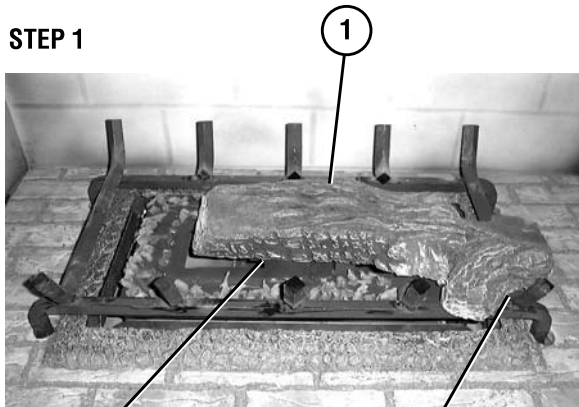

**Position Groove At The Bottom Of Log (1) Over The Burner Log Support Bracket**

**Position The Groove At The Bottom Of Log (1) Over The Grate And Slide It Forward Against The Grate Here**

### STEP 2

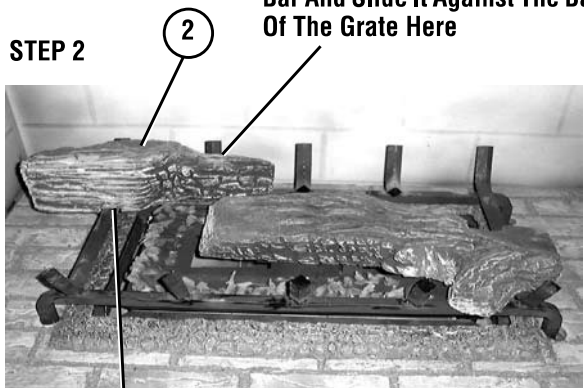

**Position Groove At The Bottom Of Log (2) Over The Grate Here And Slide It Against The Back Of The Grate**

**Position Log (2) Over The Grate Bar And Slide It Against The Back Of The Grate Here**

### STEP 3

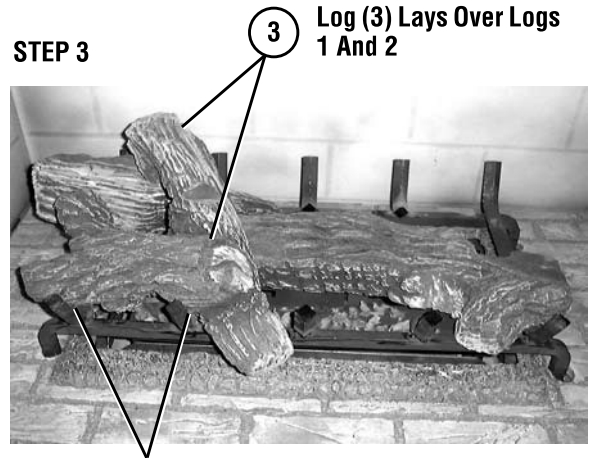

**Place Bottom Hole Of Log (3) On Pin In Log (2). Position Grooves At The Bottom Of Log (3) Over The Grate.**

**Log (3) Lays Over Logs 1 And 2**

### STEP 4

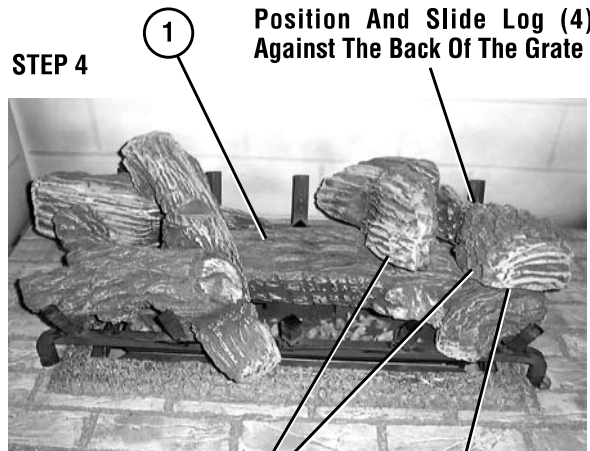

**Place Log (4) Over The Flat Spot On Log (1) Here**

**Position And Slide Log (4) Against The Back Of The Grate**

*Figure 7*

## ACCESSORY COMPONENTS

| Product Reference Information |         |              |               |
|-------------------------------|---------|--------------|---------------|
| Cat. No.                      | Model   | Ship. Weight | Ship. Volumn  |
| H0721                         | EDVSTNM | 282 lbs.     | (36.2 cu.ft.) |
| H0722                         | EDVSTNE | 282 lbs.     | (36.2 cu.ft.) |
| H0723                         | EDVSTPM | 282 lbs.     | (36.2 cu.ft.) |
| H0724                         | EDVPFNM | 270 lbs.     | (36.2 cu.ft.) |
| H0725                         | EDVPFNE | 270 lbs.     | (36.2 cu.ft.) |
| H0726                         | EDVPFPM | 270 lbs.     | (36.2 cu.ft.) |
| H0727                         | EDVCLNM | 272 lbs.     | (36.2 cu.ft.) |
| H0728                         | EDVCLNE | 272 lbs.     | (36.2 cu.ft.) |
| H0729                         | EDVCRNM | 272 lbs.     | (36.2 cu.ft.) |
| H0730                         | EDVCRNE | 272 lbs.     | (36.2 cu.ft.) |
| H0731                         | EDVCLPM | 272 lbs.     | (36.2 cu.ft.) |
| H0732                         | EDVCRPM | 272 lbs.     | (36.2 cu.ft.) |



| Remote Control Kit, Standard |           |                                  |
|------------------------------|-----------|----------------------------------|
| Cat. No.                     | Model No. | Description                      |
| H0249                        | RCL       | Remote Control System (Standard) |

### Standard Remote Control System

The Model RCL (Standard) Remote Control System, features a simplistic OFF/ON control function for the fireplace. This model includes a hand-held transmitter, a remote receiver with wall-mount cover plate and all hardware required to install the unit. The remote receiver can be wall or hearth mounted.

The transmitter has ON and OFF functions that are activated by pressing either button on the face of the transmitter. When a button on the transmitter is pressed, a signal light illuminates briefly to verify that a signal has been sent.

The Model RCL is designed to operate with all millivolt ignition systems, as well as electronic ignition systems. It may be installed with use for either natural gas or propane gas appliances. The RCL offers ease of installation and allows you to execute on-off commands to the fireplace effortlessly with one simple motion.

The Model RCL comes complete with detailed operating instructions.



| Remote Control Kit, Deluxe |           |                                |
|----------------------------|-----------|--------------------------------|
| Cat. No.                   | Model No. | Description                    |
| H0251                      | RCL-STAT  | Remote Control System (Deluxe) |

### Deluxe Remote Control System

The Model RCL-T (Deluxe) Remote Control System has all of the features of the standard system along with an added easy to read LCD screen which presents access to many enhancements, including; battery power level indicator, timer, mode of operation, thermostatic display including room temperature in either metric or English units, flame indicator and clock. Fully programmable, the Model RCL-T allows for virtual command over nearly all operational and temperature variables, using the hand held remote control transmitter.

The Model RCL-T (Deluxe) remote control system is installed in the same manner as the standard system, may be operated with electronic and millivolt systems with either natural gas or propane gas. The RCL-T comes complete with detailed operating instructions.



|   |       |        |
|---|-------|--------|
| Flame Modulating Remote Control<br>- Natural Gas    | H0301 | RCL-MN |
| Flame Modulating Remote Control<br>- LP/Propane Gas | H0302 | RCL-ML |

### Flame Modulating Remote Control

Flame Modulating Remote Controls were developed to provide a safe, reliable and user-friendly remote control system for appliances equipped with a Millivolt Gas Valve. A detailed set of instructions are included with each remote.

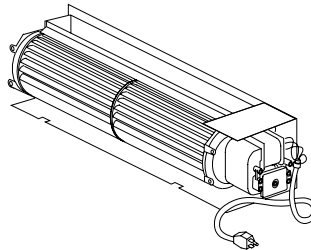

### Forced Air Kit

The FBK-100 blower provides constant velocity forced air circulation. The FBK-200 assembly with variable speed, wall-mountable switch provides variable speed forced air circulation. The FBK-250 assembly with variable speed unit-mountable switch, also provides variable speed forced air circulation.

| Forced Air Blower Kits |            |   |
|------------------------|------------|---|
| Cat. No.               | Model No.  | Description   |
| 80L84                  | FBK-100    | Blower, Standard (single speed)                             |
| 80L85                  | FBK-200    | Blower, Variable Speed (w/wall-mounted switch)              |
| 80L86                  | FBK-250    | Blower, Variable Speed (w/unit-mounted switch)              |
| 94L89                  | FBK-100-36 | Blower, Standard, 36 Pack                                   |
| 94L90                  | FBK-200-36 | Blower Kit - Variable Speed with Wall Switch 36 Pack        |
| H0543                  | FBK-250-36 | Blower Kit - Variable Speed with Thermo Snap Switch 36 Pack |

**ACCESSORY COMPONENTS CONTINUED**



| Touch-Up Paint Kits |           |                        |
|---------------------|-----------|------------------------|
| Cat. No.            | Model No. | Description            |
| 90L73               | TPK-B     | Touch-Up Paint (Black) |

**Touch-Up Paint Kit**

Repair of minor scratches and discoloration of the appliance charcoal painted surfaces may be accomplished with the touch-up paint kit.

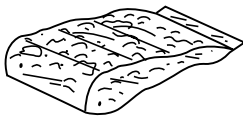

| Decorative Firebox Accessories |           |                                  |
|--------------------------------|-----------|----------------------------------|
| Cat. No.                       | Model No. | Description                      |
| 88L53                          | FGE       | Bag of Glowing Embers            |
| 80L42                          | FDVS      | Bag of Decorative Volcanic Stone |

**Bag of Glowing Embers**

**Bag of Volcanic Stone**

Replacement ember materials or volcanic stone are available for use with these appliances. Order kits as part of the periodic maintenance of the appliance.

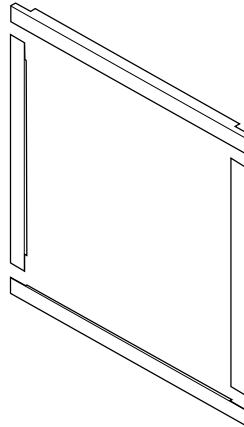

**Door Frame Kits**

A decorative door frame kit is available for use with these appliances. The DTK is designed to attach directly to the front face of the appliance at its extreme edges. The DTK provides a picture frame finish for the appliance. The door frame kit can be retrofitted onto previously installed appliances.

| Door Frame Kits<br>CATALOG NO. / MODEL NO. AND NUMBER OF SETS |                            |                            |                            |                            |
|---|----------------------------|----------------------------|----------------------------|----------------------------|
| Unit Model No.  | Polished Brass Finish      |                            | Brushed Stainless Finish   |                            |
|   | for 24 in. wide Glass Door | for 40 in. wide Glass Door | for 24 in. wide Glass Door | for 40 in. wide Glass Door |
|   | 88L43<br>DTK24PB-2         | 88L45<br>DTK40PB-2         | 90L69<br>DTK24BS           | 90L71<br>DTK40BS           |
| EDVST   | -                          | 2                          | -                          | 2                          |
| EDVPF   | 1                          | 2                          | 1                          | 2                          |
| EDVCR<br>EDVCL  | 1                          | 1                          | 1                          | 1                          |

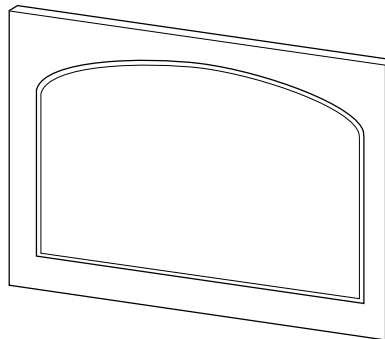

**Arch Door Kits**

Two types of arch door kits are available for the Multi-Open Series. Both types of kits are easy to install and do not require hardware to attach them to the standard door frame. These kits can be retrofitted to previously installed Multi-Open Series appliances. The decorative arch kits can not be used in conjunction with the screen panel kit.

| Arch Door Kits - CATALOG NO. / MODEL NO. AND QUANTITY |                            |                            |                            |                            |
|---|----------------------------|----------------------------|----------------------------|----------------------------|
| Unit Model No.  | Polished Brass Finish      |                            | Brushed Stainless Finish   |                            |
|   | for 24 in. wide Glass Door | for 40 in. wide Glass Door | for 24 in. wide Glass Door | for 40 in. wide Glass Door |
|   | 81L37<br>ADK24CPB          | 81L35<br>ADK40CPB          | 98L71<br>ADK24CBS          | 98L69<br>ADK40CBS          |
| EDVST   | -                          | 2                          | -                          | 2                          |
| EDVPF   | 1                          | 2                          | 1                          | 2                          |
| EDVCR<br>EDVCL  | 1                          | 1                          | 1                          | 1                          |

NOTE: DIAGRAMS & ILLUSTRATIONS ARE NOT TO SCALE.

**ACCESSORY COMPONENTS CONTINUED**



| Wall Thermostat, Millivolt |           |                            |
|----------------------------|-----------|----------------------------|
| Cat. No.                   | Model No. | Description                |
| H4635                      | DWTK      | Wall Thermostat Kit, White |

**Digital Wall Thermostat**

The wall thermostat kit provides temperature control for optimum comfort.

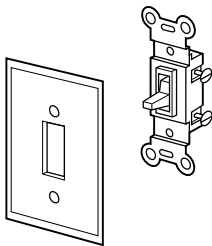

| White Wall Switch Kit |           |                        |
|-----------------------|-----------|------------------------|
| Cat. No.              | Model No. | Description            |
| 85L87                 | FWSK      | OFF/ON Wall Switch Kit |

**OFF/ON Wall Switch Kit**

The OFF/ON wall switch kit may be used to control the operation of the fireplace burner. Install the OFF/ON wall switch in a convenient location near the fireplace.

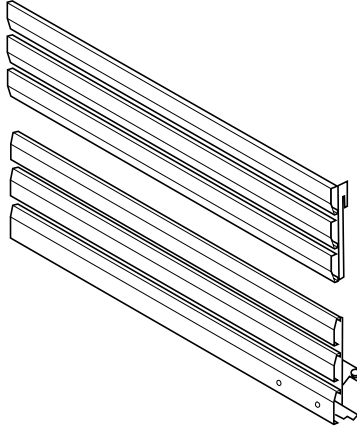

**Black Finish Louvers Kits**

Decorative louvers are available for use with all Multi-Open Series appliances. These louvers are designed to replace the standard radiant panels that are provided with the appliance. These kits include a black finish top 3-piece assembly and a bottom 3-piece assembly. These kits can be retrofitted to previously installed appliances.

| Black Finish Louver Assembly Kits<br>(3-piece Top and 3-piece Bottom Assembly)<br>CATALOG NO. / MODEL NO. AND NUMBER OF SETS |                            |                            |
|--|----------------------------|----------------------------|
| Unit Model No.   | Black Finish               |                            |
|  | for 24 in. wide Glass Door | for 40 in. wide Glass Door |
|  | 88L23<br>LVR24C-2          | 88L25<br>LVR40C-2          |
| EDVST  | -                          | 2                          |
| EDVPF  | 1                          | 2                          |
| EDVCR<br>EDVCL   | 1                          | 1                          |

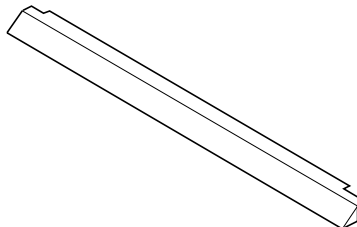

**Polished Brass and Brushed Stainless Hood Kits**

Attractive hoods are available in two styles to be used on the Multi-Open Series appliances. These hoods are designed to be fitted to the glass viewing sides of the appliance. In addition to providing an aesthetically pleasing appearance to your appliance installation, the hood reduces heat effects to decorative mantles and finish materials located above the fireplace opening. The hood kit replaces the standard hood that comes with these appliances and snaps into place. These kits can be retrofitted to previously installed appliances.

| Hood Kits<br>CATALOG NO. / MODEL NO. AND NUMBER OF SETS |                            |                            |                            |                            |
|---|----------------------------|----------------------------|----------------------------|----------------------------|
| Unit Model No.  | Polished Brass Finish      |                            | Brushed Stainless Finish   |                            |
|   | for 24 in. wide Glass Door | for 40 in. wide Glass Door | for 24 in. wide Glass Door | for 40 in. wide Glass Door |
|   | 96K28<br>EB24PB            | 96K68<br>EB40PB            | 88L47<br>EB24BS            | 88L50<br>EB40BS            |
| EDVST   | -                          | 2                          | -                          | 2                          |
| EDVPF   | 1                          | 2                          | 1                          | 2                          |
| EDVCR<br>EDVCL  | 1                          | 1                          | 1                          | 1                          |

**ACCESSORY COMPONENTS CONTINUED 1**

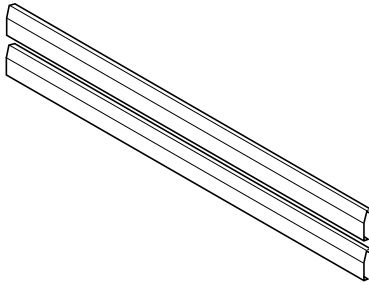

**2-Piece Polished Brass and Brushed Stainless Louvers Kits**

Decorative louvers are available for use with all Multi-Open Series appliances. These louvers are designed to replace either the middle charcoal louver of each set or the charcoal louver in each set closest to the glass door. These kits include two narrow louvers. They provide a touch of elegance to any Multi-Open Series appliance. These kits can be retrofitted to previously installed appliances.

| <b>Louver Kits (2-piece)</b>                      |                                   |                                   |                                   |                                   |
|---|-----------------------------------|-----------------------------------|-----------------------------------|-----------------------------------|
| <b>CATALOG NO. / MODEL NO. AND NUMBER OF SETS</b> |                                   |                                   |                                   |                                   |
| <b>Unit Model No.</b>                             | <b>Polished Brass Finish</b>      |                                   | <b>Brushed Stainless Finish</b>   |                                   |
|   | <b>for 24 in. wide Glass Door</b> | <b>for 40 in. wide Glass Door</b> | <b>for 24 in. wide Glass Door</b> | <b>for 40 in. wide Glass Door</b> |
|   | <b>96L04<br/>2LVR24PB</b>         | <b>96L06<br/>2LVR40PB</b>         | <b>96L08<br/>LVR24BS</b>          | <b>96L10<br/>LVR40BS</b>          |
| <b>EDVST</b>                                      | -                                 | 2                                 | -                                 | 2                                 |
| <b>EDVPF</b>                                      | 1                                 | 2                                 | 1                                 | 2                                 |
| <b>EDVCR<br/>EDVCL</b>                            | 1                                 | 1                                 | 1                                 | 1                                 |

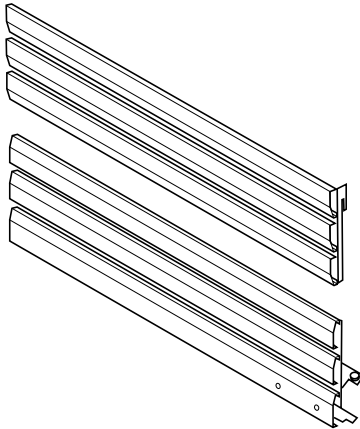

**Polished Brass and Brushed Stainless Louvers Kits**

Decorative louvers are available for use with all Multi-Open Series appliances. These louvers are designed to replace the standard radiant panels that are provided with the appliance. These kits include a top 3-piece assembly and a bottom 3-piece assembly. They provide a touch of elegance to any Multi-Open Series appliance. These kits can be retrofitted to previously installed appliances.

| <b>Louver Assembly Kits (3-piece Top and 3-piece Bottom Assembly)</b> |                                   |                                   |                                   |                                   |
|---|-----------------------------------|-----------------------------------|-----------------------------------|-----------------------------------|
| <b>CATALOG NO. / MODEL NO. AND NUMBER OF SETS</b>                     |                                   |                                   |                                   |                                   |
| <b>Unit Model No.</b>   | <b>Polished Brass Finish</b>      |                                   | <b>Brushed Stainless Finish</b>   |                                   |
|   | <b>for 24 in. wide Glass Door</b> | <b>for 40 in. wide Glass Door</b> | <b>for 24 in. wide Glass Door</b> | <b>for 40 in. wide Glass Door</b> |
|   | <b>88L27<br/>LVR24PB-2</b>        | <b>88L29<br/>LVR40PB-2</b>        | <b>88L31<br/>LVR24BS</b>          | <b>88L33<br/>LVR40BS</b>          |
| <b>EDVST</b>  | -                                 | 2                                 | -                                 | 2                                 |
| <b>EDVPF</b>  | 1                                 | 2                                 | 1                                 | 2                                 |
| <b>EDVCR<br/>EDVCL</b>  | 1                                 | 1                                 | 1                                 | 1                                 |

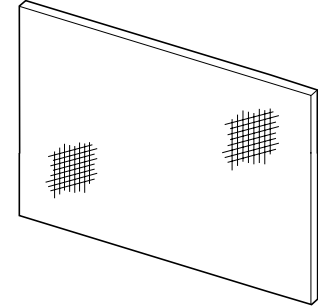

|                         |              |             |
|-------------------------|--------------|-------------|
| <b>Screen Panel Kit</b> |              |             |
| 24 inch Wide Glass Door | <b>98K74</b> | <b>HG24</b> |
| 40 inch Wide Glass Door | <b>96K32</b> | <b>HG40</b> |

**Screen Panel Kit**

An optional screen panel can be installed on the Multi-Open Series doors. These screen panels are easy to install. These kits can be retrofitted to previously installed appliances. The screen panel kits can not be used in conjunction with either of the arch door kits or door frame kits.

**ACCESSORY COMPONENTS CONTINUED**

| <b>Bricaded Panel Liner Kits</b> |                                  |
|----------------------------------|----------------------------------|
| <b>Model No.</b>                 | <b>Catalog No.<br/>Model No.</b> |
| <b>EDVPF</b>                     | H0778<br>EBLK-PF                 |
| <b>EDVST</b>                     | H0779<br>EBLK-ST                 |
| <b>EDVCL</b>                     | H0780<br>EBLK-CL                 |
| <b>EDVCR</b>                     | H0781<br>EBLK-CR                 |

The brickaded liner kits include ceramic panels as shown here. The panels have brick-like features in relief.

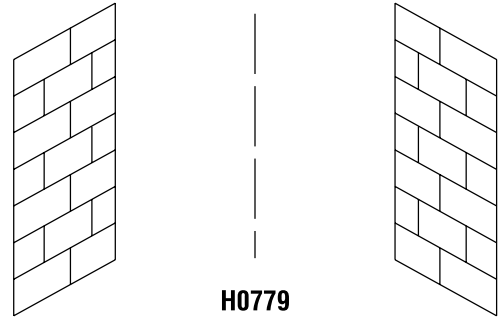

**H0779  
(Top Vent)**

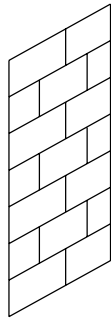

**H0778  
(Top Vent)**

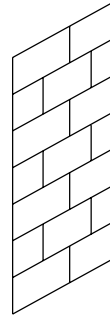

**H0780 & H0781  
(Top Vent)**

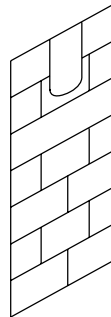
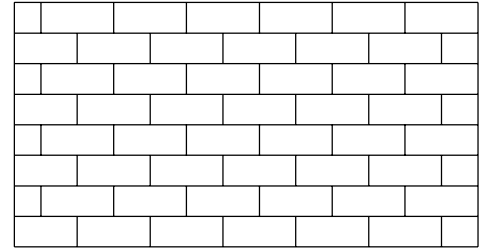

**H0779  
(Rear Vent)**

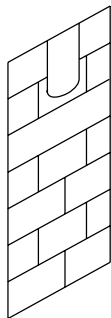
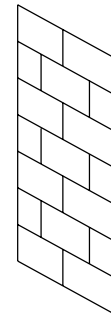

**H0778  
(Rear Vent)**

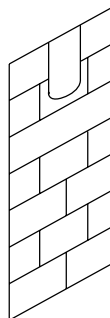

**H0780 & H0781  
(Rear Vent)**

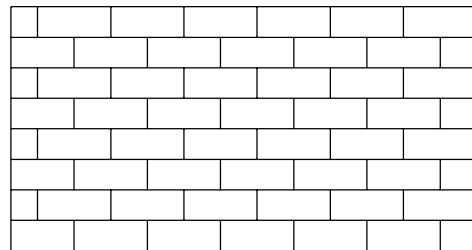

**ACCESSORY COMPONENTS CONTINUED**

**Style View Doors -**

Style View Doors come in 4 beautiful styles. They are easy to install and will not require hardware to attach them to the standard glass door frame. The door includes heavy duty magnet door latches and functional twin-pane doors.

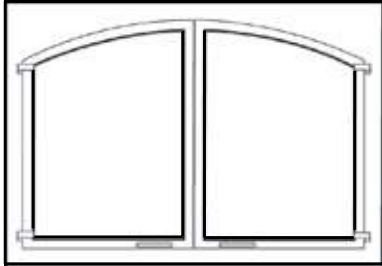

**Arch Design**

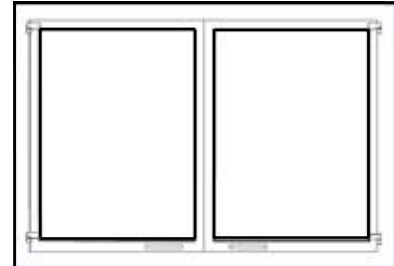

**Square Design**

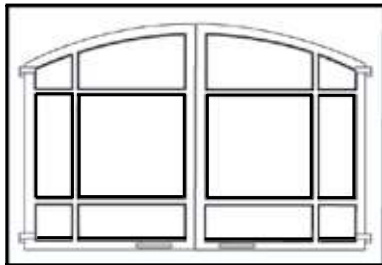

**Arch Pane Design**

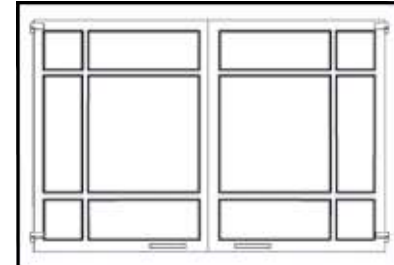

**Square Pane Design**

| <b>ARCH DESIGN KITS</b>      |         |                                    |                                  |
|------------------------------|---------|------------------------------------|----------------------------------|
| Cat. No.                     | Model   | Description                        | Model Series                     |
| H0862                        | AD40C   | 40" Arch Doors, Black              | EDVST<br>EDVPF<br>EDVCR<br>EDVCL |
| H0863                        | AD40TI  | 40" Arch Doors, Textured Iron      |                                  |
| H0864                        | AD40SP  | 40" Arch Doors, Satin Pewter       |                                  |
| H0865                        | AD40AB  | 40" Arch Doors, Antique Brass      |                                  |
| <b>ARCH PANE DESIGN KITS</b> |         |                                    |                                  |
| H0934                        | APD40C  | 40" Arch Pane Doors, Black         | EDVST<br>EDVPF<br>EDVCR<br>EDVCL |
| H0935                        | APD40TI | 40" Arch Pane Doors, Textured Iron |                                  |
| H0936                        | APD40SP | 40" Arch Pane Doors, Satin Pewter  |                                  |
| H0937                        | APD40AB | 40" Arch Pane Doors, Antique Brass |                                  |

| <b>SQUARE DESIGN KITS</b>      |         |                                   |                                  |
|--------------------------------|---------|-----------------------------------|----------------------------------|
| Cat. No.                       | Model   | Description                       | Model Series                     |
| H0950                          | SD40C   | 40" Sq. Doors, Black              | EDVST<br>EDVPF<br>EDVCR<br>EDVCL |
| H0951                          | SD40TI  | 40" Sq. Doors, Textured Iron      |                                  |
| H0952                          | SD40SP  | 40" Sq. Doors, Satin Pewter       |                                  |
| H0953                          | SD40AB  | 40" Sq. Doors, Antique Brass      |                                  |
| <b>SQUARE PANE DESIGN KITS</b> |         |                                   |                                  |
| H0966                          | SPD40C  | 40" Sq. Pane Doors, Black         | EDVST<br>EDVPF<br>EDVCR<br>EDVCL |
| H0967                          | SPD40TI | 40" Sq. Pane Doors, Textured Iron |                                  |
| H0968                          | SPD40SP | 40" Sq. Pane Doors, Satin Pewter  |                                  |
| H0969                          | SPD40AB | 40" Sq. Pane Doors, Antique Brass |                                  |

**ACCESSORY COMPONENTS CONTINUED**

**Style View Doors Continued -**

Style View Doors also come in a Tall Arch Pane Design. Two distinctive grille kits, the “Crescents” and “Sunrise” design, are also offered separately. They are easy to install and will not require hardware to attach them to the standard glass door frame. The door includes heavy duty magnet door latches and functional twin-pane doors.

**Tall Arch Pane Door**

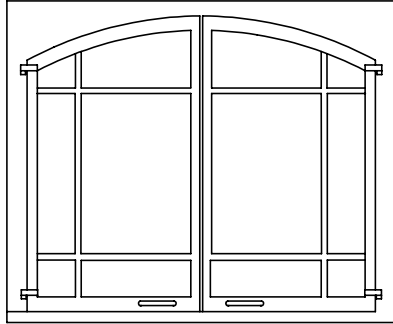

| TALL ARCH PANE DOORS |          |                                   |              |
|----------------------|----------|-----------------------------------|--------------|
| Cat. No.             | Model    | Description                       | Model Series |
| H3529                | TAPD40C  | 40" Arch Pane Doors, Black        | EDVST        |
| H3531                | TAPD40SP | 40" Arch Pane Doors, Satin Pewter |              |

**Crescents Grille Kits**

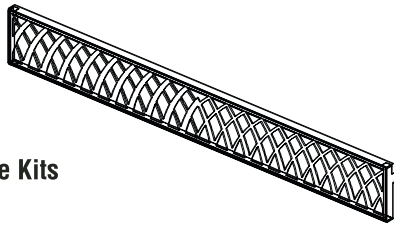

**Sunrise Grille Kits**

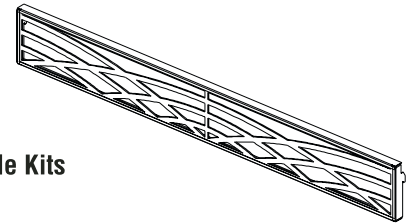

| “Crescents” Grille Kits |          |  |              |
|-------------------------|----------|--|--------------|
| Cat. No.                | Model    | Description                                  | Model Series |
| H3549                   | CUGK40C  | 40" Crescents Upper Grille Kit, Black        | EDVST        |
| H3551                   | CUGK40SP | 40" Crescents Upper Grille Kit, Satin Pewter |              |
| H3553                   | CLGK40C  | 40" Crescents Lower Grille Kit, Black        |              |
| H3555                   | CLGK40SP | 40" Crescents Lower Grille Kit, Satin Pewter |              |

| “Sunrise” Grille Kits |          |  |              |
|-----------------------|----------|--|--------------|
| Cat. No.              | Model    | Description                                | Model Series |
| H3573                 | SUGK40C  | 40" Sunrise Upper Grille Kit, Black        | EDVST        |
| H3575                 | SUGK40SP | 40" Sunrise Upper Grille Kit, Satin Pewter |              |
| H3577                 | SLGK40C  | 40" Sunrise Lower Grille Kit, Black        |              |
| H3579                 | SLGK40SP | 40" Sunrise Lower Grille Kit, Satin Pewter |              |

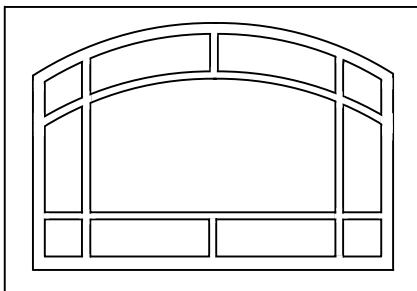

**Arch Screen Panel Kit**  
40" Decorative Arch Screen Panel Kit - Textured Iron

**Model No.**  
DASPK40TI

**Catalog No.**  
H3594

This screen panel kit can be installed on the glass enclosure panel to prevent direct contact with the hot glass surface. The panel kit adds a new design choice with a handsome textured iron finish. The screen panel kit cannot be used in conjunction with either of the arch door kits or door frame kits.

## REPLACEMENT PARTS LIST

| No. | DESCRIPTION                            | Natural and Propane |       |       |       |       |      |
|-----|--|---------------------|-------|-------|-------|-------|------|
|     |  | Part No.            | Qty.  | Qty.  | Qty.  | Qty.  |      |
|     |  |                     | EDVST | EDVPF | EDVCL | EDVCR |      |
| 1a  | Upper Radiant, Black - 24 in.          | H3723               | none  | 1     | 1     | 1     |      |
| 1b  | Upper Radiant, Black - 40 in.          | H3722               | 2     | 2     | 1     | 1     |      |
| 2a  | Hood, Black - 24 in.                   | 98K95               | none  | 1     | 1     | 1     |      |
| 2b  | Hood, Black - 40 in.                   | 97K52               | 2     | 2     | 1     | 1     |      |
| 3a  | Upper Bustle, Black - 24 in.           | H3743               | none  | 1     | 1     | 1     |      |
| 3b  | Upper Bustle, Black - 40 in.           | H3741               | 2     | 2     | 1     | 1     |      |
| 4a  | Glass Enclosure Assembly - 24 in.      | H3725               | none  | 1     | 1     | 1     |      |
| 4b  | Glass Enclosure Assembly - 40 in.      | H3724               | 2     | 2     | 1     | 1     |      |
| 5a  | Lower Bustle, Black - 24 in.           | H3731               | none  | 1     | 1     | 1     |      |
| 5b  | Lower Bustle, Black - 40 in.           | H3729               | 2     | 2     | 1     | 1     |      |
| 6a  | Lower Radiant Assembly, Black - 24 in. | H3733               | none  | 1     | 1     | 1     |      |
| 6b  | Lower Radiant Assembly, Black - 40 in. | H3732               | 2     | 2     | 1     | 1     |      |
| 7   | Nameplate (Brand)                      | 12L15               | 2     | 2     | 1     | 1     |      |
| 8   | Log Set                                | 55M04               | 1     | 1     | 1     | 1     |      |
| 9   | Grate Assembly                         | H3358               | 1     | 1     | 1     | 1     |      |
| 10  | Magnet, Radiant Panel                  | H3876               | 2     | 4     | 3     | 3     |      |
| 11  | Burner Assembly                        | 55M42               | 1     | 1     | 1     | 1     |      |
| 12  | Gasket, Burner Tray Mounting           | 19L51               | 1     | 1     | 1     | 1     |      |
| 13  | Gasket, Venturi Tube Mounting          | 43K85               | 1     | 1     | 1     | 1     |      |
| 14  | Venturi Tube Arm                       | 42M80               | 1     | 1     | 1     | 1     |      |
| 15a | Modesty Panel - PF, CL                 | Millivolt           | H3386 | none  | 1     | 1     | none |
| 15b |  | Electronic          | H3385 | none  | 1     | 1     | none |
| 15c | Modesty Panel - ST, CR                 | Millivolt           | H3388 | 1     | none  | none  | 1    |
| 15d |  | Electronic          | H3387 | 1     | none  | none  | 1    |
| 16  | Latch, Glass Enclosure Panel           | 69L21               | 4     | 6     | 4     | 4     |      |
| 17  | Magnet, Latch, Spring-Loaded           | 69L31               | 2     | 2     | 1     | 1     |      |
| 18  | Switch, Rocker                         | 80L41               | 1     | 1     | 1     | 1     |      |
| 19  | Air Shutter Adjustment Rod             | H3707               | 1     | 1     | 1     | 1     |      |
| 20  | Flex Line Gas Connector                | 93L32               | 1     | 1     | 1     | 1     |      |

**Note:** Ordering information for Volcanic Stone, Glowing Embers and Touch-up Paint can be found on **Page 19**.

REPLACEMENT PARTS LIST CONTINUED

**GAS CONTROLS — SIT MILLIVOLT**

| No. | DESCRIPTION             | Natural  |      | Propane  |      |
|-----|-------------------------|----------|------|----------|------|
|     |                         | Part No. | Qty. | Part No. | Qty. |
| 30. | Gas Valve - SIT         | 43K07    | 1    | 88J53    | 1    |
| 31. | Piezo Igniter           | 10K86    | 1    | 10K86    | 1    |
| 32. | Pilot Assembly          | 69L17    | 1    | 69L18    | 1    |
| 33. | Pilot Generator         | 60J79    | 1    | 60J79    | 1    |
| 34. | Thermocouple            | 74L57    | 1    | 74L57    | 1    |
| 35. | Pilot Tube              | 74L56    | 1    | 74L56    | 1    |
| 36. | Electrode And Cable     | 74L58    | 1    | 74L58    | 1    |
| 37. | Orifice                 | 21L81    | 1    | 21L82    | 1    |
| 38. | Sticker (Modesty Panel) | 31L22    | 1    | 31L22    | 1    |

**GAS CONTROLS — HONEYWELL ELECTRONIC**

| No. | DESCRIPTION             | Natural  |      |
|-----|-------------------------|----------|------|
|     |                         | Part No. | Qty. |
| 40. | Gas Valve - Honeywell   | 62L18    | 1    |
| 41. | Pilot Assembly          | 62L14    | 1    |
| 42. | Transformer             | 42J32    | 1    |
| 43. | Ignitor Assembly (Kit)  | 87L54    | 1    |
| 44. | Orifice                 | 21L81    | 1    |
| 45. | Sticker (Modesty Panel) | 69L50    | 1    |
| 46. | Pilot Tube              | H3720    | 1    |

Contact an Authorized Lennox Hearth Products dealer to obtain any of these parts. Never use substitute materials. Use of non-approved parts can result in poor performance and safety hazards.

**⚠ WARNING**

Failure to position the parts in accordance with these diagrams or failure to use only parts specifically approved with this appliance may result in property damage or personal injury.

**⚠ AVERTISSEMENT**

Risque de dommages ou de blessures si les pièces ne sont pas installées conformément à ces schémas et ou si des pièces autres que celles spécifiquement approuvées avec cet appareil sont utilisées.

# REPLACEMENT PARTS

**Cabinet**

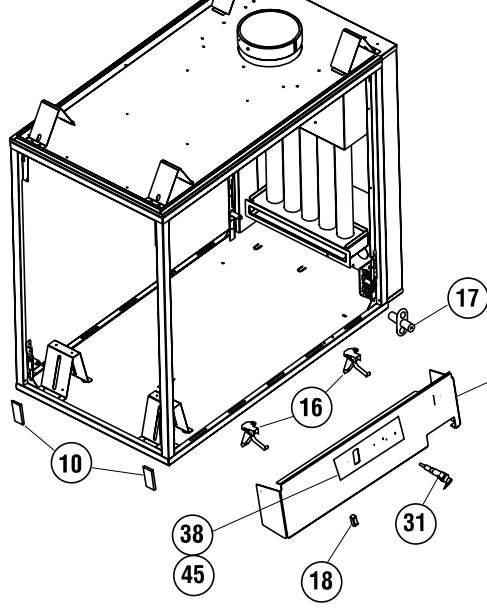

**Firebox**

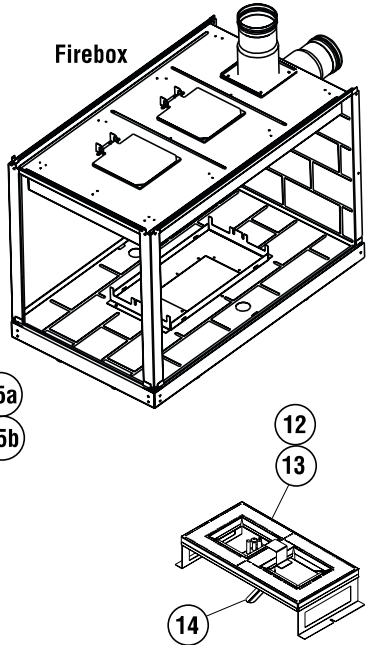

EDVPF Shown - see table on page 30 and 31 for replacement parts applicable to EDVST, EDVCR and EDVCL

