



**GAS VAC  
PARTS LIST**

**Model  
V1900**

DEC/2016

# INDEX

INTRODUCTION.....	PAGE 3
TERMS & CONDITIONS OF SALE.....	PAGE 4 & 5
SAFETY & HAZARDOUS WARNING.....	PAGE 6
FILTER INFORMATION.....	PAGE 7
WARRANTY BREAKDOWN.....	PAGE 8
OPERATION & MAINTAINENCE.....	PAGE 9 - 12
VACUUM PARTS	
BODY GROUP.....	PAGE 13 - 15
AIR GROUP.....	PAGE 16 - 18
ADDITIONAL SPARE PARTS.....	PAGE 19

# INTRODUCTION

## **FORWARD**

**WARNING** READ THIS MANUAL CAREFULLY PRIOR TO OPERATING THE EQUIPMENT IN ORDER TO UNDERSTAND HOW TO OPERATE AND SERVICE THE EQUIPMENT CORRECTLY. FAILURE TO PROPERLY REVIEW THIS MANUAL COULD RESULT IN PERSONAL INJURY OR EQUIPMENT DAMAGE.

This manual should be considered a permanent part of the equipment and should remain with the equipment at all times. Please note the following:

Measurements in this manual are given in metric and standard U.S. measurement equivalents.

Use only correct replacement parts and fasteners. Fasteners may require specific tools.

Right and left hand sides are determined by facing forward while sitting in the seat behind the steering wheel.

## **THIRD-PARTY MANUFACTURER INFORMATION**

This equipment contains an engine manufactured by a third-party manufacturer. This engine may be covered by the manufacturer's standard factory warranty and the manufacturer may require that all repairs and/or service be completed pursuant to its warranty terms and conditions. Please refer to the product manual and Warranty Breakdown for additional information on this warranty and any registration requirements.

## GENERAL SAFETY & HAZARDOUS MATERIALS WARNING

**WARNING** SURFACE PREPARATION EQUIPMENT CAN BE DANGEROUS IF NOT OPERATED PROPERLY. THE OPERATOR IS RESPONSIBLE FOR THE SAFE OPERATION OF THIS EQUIPMENT. The operator must carefully read and follow any warnings or safety instructions provided with the equipment prior to operating the equipment. Do not remove any safety devices or warnings on the equipment.

**WARNING** FLOOR AND/OR DECK SURFACES MAY BE COATED WITH OR CONTAMINATED BY HAZARDOUS MATERIALS. Typical examples of hazardous materials include (i) tile mastic (likely to contain *asbestos*); (ii) stained areas near electrical equipment (potentially containing *PCBS*); (iii) paint (potentially containing *lead*); (iv) stained floor areas in chemical or other industrial facilities (potentially containing toxic *pesticides, cleaning fluids, solvents, or other harmful chemicals*).

**WARNING** Preparation equipment is used to remove surface material from a variety of surfaces. The surface preparation process often generates large amounts of dust and other small particles, which are released into the air. WHEN A SURFACE CONTAINS HAZARDOUS MATERIALS, EXPOSURE TO THE DUST GENERATED BY THE PREPARATION EQUIPMENT MAY POSE A HEALTH RISK. INSPECT ALL SURFACES FOR POSSIBLE CONTAMINATES PRIOR TO USING PREPARATION EQUIPMENT AND CONSULT HAZARDOUS MATERIAL EXPERTS AND GOVERNMENT AUTHORITIES BEFORE OPERATING PREPARATION EQUIPMENT ON SURFACES SUSPECTED OF CONTAINING HAZARDOUS MATERIALS.

**WARNING** BW MANUFACTURING, INC. IN NO WAY REPRESENTS THAT ITS PREPARATION EQUIPMENT IS SUITABLE OR APPROVED FOR REMOVING HAZARDOUS MATERIALS FROM CONTAMINATED SURFACES. DO NOT ATTEMPT TO USE ANY PREPARATION EQUIPMENT MANUFACTURED BY BW MANUFACTURING, INC. ON ANY CONTAMINATED SURFACE. It is the responsibility of the preparation equipment operator and/or the contractor using the preparation equipment to inspect the proposed worksite for contaminants and obtain approval from contamination experts and/or government authorities before using BW Manufacturing, Inc. preparation equipment. It is also the responsibility of any contractor using preparation equipment to inform its employees or subcontractors of all potential health risks associated with operating preparation equipment and to ensure its employees or subcontractors are protected from exposure to harmful materials.

BW MANUFACTURING, INC. IS NOT RESPONSIBLE FOR ANY INJURY, ILLNESS, DEATH, OR PROPERTY DAMAGE THAT MAY RESULT FROM IMPROPER USE OF ITS PREPARATION EQUIPMENT OR OTHER PRODUCTS

# DIAMOND PRODUCTS

## NEW FILTER APPLICATIONS

**New filters will flow noticeable dust for the first 10 to 15 minutes of use or until the filter is adequately coated with material. The filter cleans to 99.950 efficiency at 2 microns and therefore the filter will allow a minimal amount of dust through the filter on every pulsation cycle even after filter is fully loaded.**

Further tests have shown that humidity and concrete dampness will affect the efficiency of the pulsation system to clean the filter.

- Stock filter included with V1900 is part # 2505796
- Optional filter is a Moisture Resistant “Duct Back” Filter part # 10129-D
- Optional filter is a HEPA filter part # 2505797 (*Special Order*)



### **2505796**

Filter (Blend) (*Standard*)  
99.7% Efficiency @ .05 Microns

### **10129-D**

Moisture Resistant (*Optional*)  
99% Efficiency @ 1-2 Microns

### **2505797**

HEPA (*Special Order*)  
99.995% Efficiency @ .03 Microns

## WARRANTY BREAKDOWN

Item	NONE	90 DAYS	1YEAR	2 YEARS	WARRANTED BY:
Chassis			○		B W Mfg., Inc.
Engine (gas)			○		Honda Power
Engine (gas)				○	Subaru Robin
Engine (220V)			○		Leeson Elect.
Compressor			○		B W Mfg., Inc.
Dust Filters	○				B W Mfg., Inc.

## WARRANTY CONTACT INFORMATION

<b>B W Mfg., Inc.</b>	<b>B W Manufacturing, Inc.</b>
	Voice: 616-447-9076
	Fax: 616-447-9078
	E-mail: <a href="mailto:info@bwmanufacturing.com">info@bwmanufacturing.com</a>
	<b><i>Warranty does not include travel time</i></b>
<b>Subaru Robin</b>	<b>Subaru Robin</b>
	940 Lively Blvd.
	Wood Dale, IL 60191-1204
	Phone: 800-277-6246
	<i>E-mail:</i> <a href="mailto:website.warranty@robinamerica.com">website.warranty@robinamerica.com</a>
<b>Honda Power Equipment Group</b>	<b>Honda Power Equip. Group</b>
	4900 Marconi Dr.
	Alpharetta, GA 30005-8847
	Phone: 770-497-6400
	<i>Website:</i> <a href="http://www.honda-engines.com">www.honda-engines.com</a>
<b>Leeson Elect.</b>	<b>Leeson Electric Corp.</b>
	2100 Washington Street
	P.O. Box 241
	Grafton, WI 53024-0241
	Phone: 262-377-8810
	E-mail: <a href="mailto:leeson@leeson.com">leeson@leeson.com</a>

# V1900 GAS VAC OPERATING & MAINTENANCE INSTRUCTIONS

## Starting Instructions For Models Equipped With A Gas Engine

Begin by turning the gas valve to the OPEN position (1), then place the power switch in the ON position (2), adjusting the choke (3), place throttle in wide open position (4), and pull the starting handle (5 *not shown*). As motor begins to run you will need to adjust the choke (3) until the engine runs smoothly.

To turn off engine, start by placing the power switch (2) in the OFF position, and return the gas valve (1) to the CLOSE position.

Robin/Subaru Engine

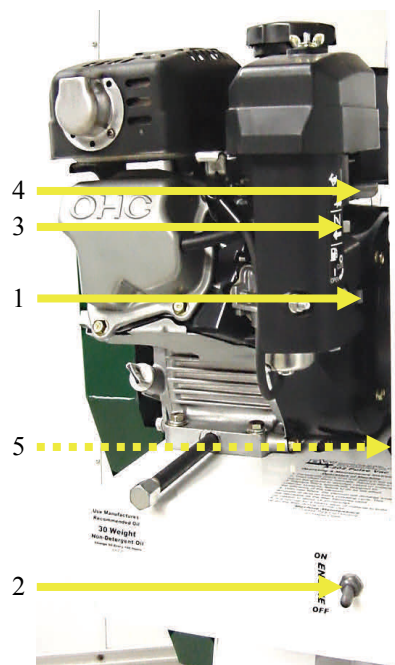

## Gas Engine Maintenance Instructions

Clean engine air filter every day  
Change engine oil after first 20 hours of operation and every 100 afterward.

## Starting Instructions For Models Equipped With An Electric Engine

### 220V Single Phase

Plug unit into a 220 volt, 30 amp service and turn on machine using ON/OFF Switch (6).

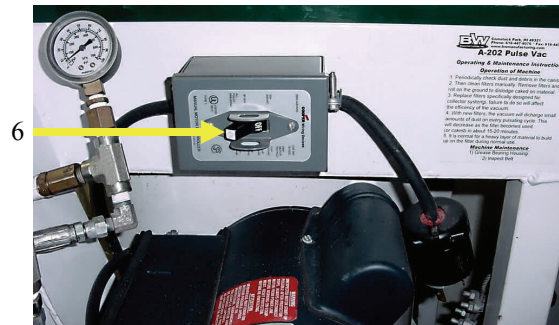

# V1900 GAS VAC OPERATING & MAINTENANCE INSTRUCTIONS

## Greasing The Blower Bearing Housing

Grease every 8 hours (A)

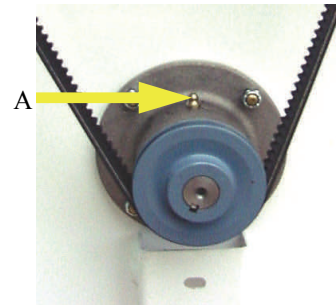

## Filter Inspection & Maintenance

Routine inspection of filters (B)

### To Clean Filter Manually:

Rotate the filter and gently tap the filter sides on the ground. Adverse conditions on the filters such as heavy grease, oil, glues, and moisture may require more frequent manual cleaning or replacement.

*(Using filters that are **not designed** for collector systems will cause a decrease in vacuum and will reduce paddle and liner life).*

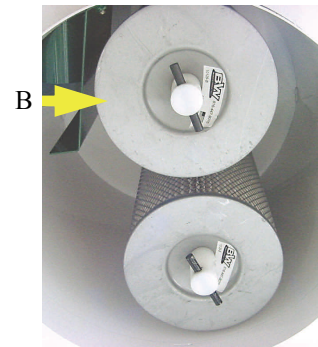

## Unloader Valve Settings

Valve #1 is preset at factory (E)

Valve #2 is preset at factory (F)

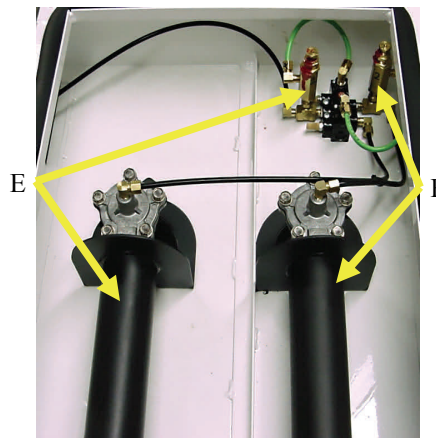

## Gas Engine & Air Compressor Maintenance

Using manufactures recommended oil (30 Weight Non-Detergent Oil) changing every 100 hours of operation (G).

Check compressor air filter (H) and engine air filter (I) every 8 hours of operation.



# V1900 GAS VAC OPERATING & MAINTENANCE INSTRUCTIONS

## Dust Drum Removal and Installation

To remove drum for emptying, start by turning the winch handle counter clockwise (1) to lower the drum. Once there is slack in the cable, unhook the pulley (2) from either side of the drum and push chassis of vacuum back. Once drum is clear of the chassis it is ready to be emptied of debris and dust.

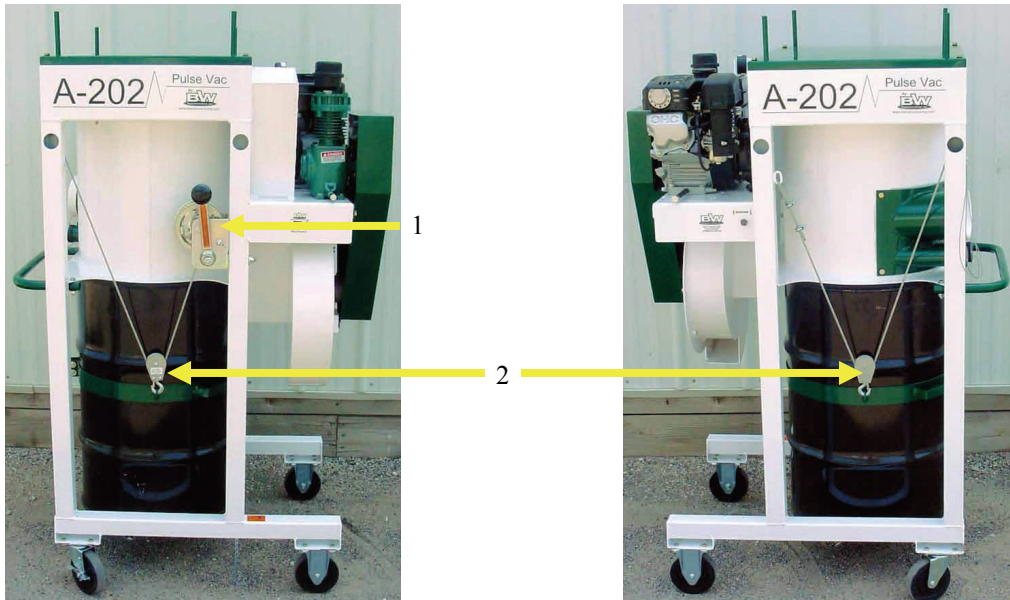

# V1900 GAS VAC OPERATING & MAINTENANCE INSTRUCTIONS

## Dust Filter Cleaning & Replacement.

To clean filter manually, rotate the filter and gently tap the filter sides on the ground. Adverse conditions on the filters such as heavy grease, oil, glues, and moisture may require more frequent manual cleaning or replacement.

## To determine if you have a bad dust filter.

Watch the indicator lights on the timer board and blower exhaust while the machine is in operation. If a puff of dust follows an indicator light, that filter is bad and should be replaced. Or when inspecting filters you find a layer of dust on the top of the filter inside the rubber seal ring, this is an indication that the filter is bad and needs to be replaced.



*(Using filters that are **not** designed for collector systems will cause a decrease in vacuum and will reduce paddle and liner life).*

Good Filter

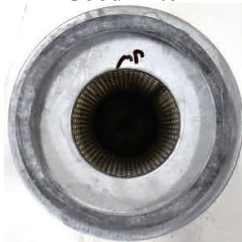

Bad Filter



This is the 10129-B Filter that is the stock filter in all BW Manufacturing, Inc. equipment.

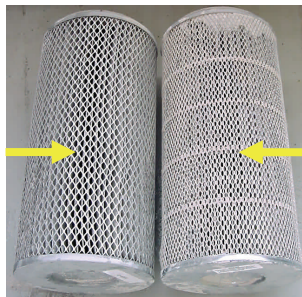

This is a competitors filter.

Both filters were installed in the same machine and you can see that the filter on the right has more pleats along with dust packed near the top rim.



The 10129-B Filter on the left weighs over 2 lbs. less than the competitors filter due to better air flow during the pulsation process.



# V1900 GAS VAC BODY GROUP

- 1. W-36-AS Belt Guard
- 2. B-1647 Wire Rope Clip
- 3. W-23-AS Collector Lid
- 4. W-31-AS Intake Assembly
- 5. W-0017 Caster (Stationary)
- 6. W-0019 Caster (Swivel)

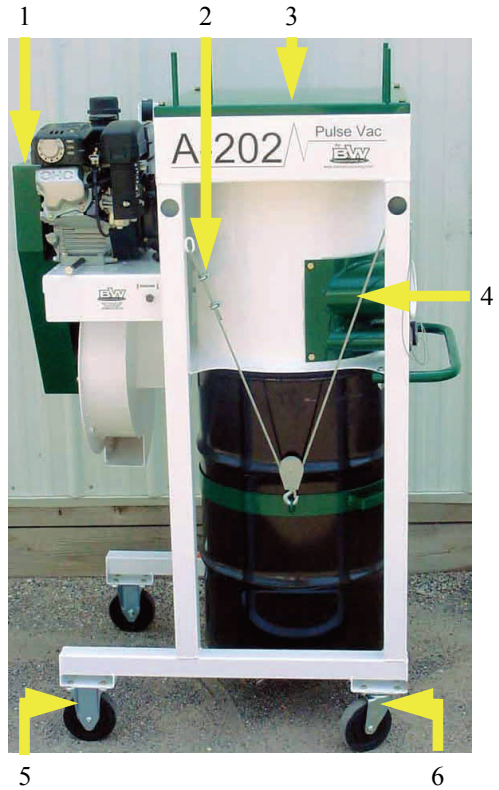

- 1. I-130 Winch
- 2. W-06-AS Collector Body
- 3. W-0001-AS Drum Assembly
- 4. I-143 Pulley W/Hook
- 5. W-35 Handle

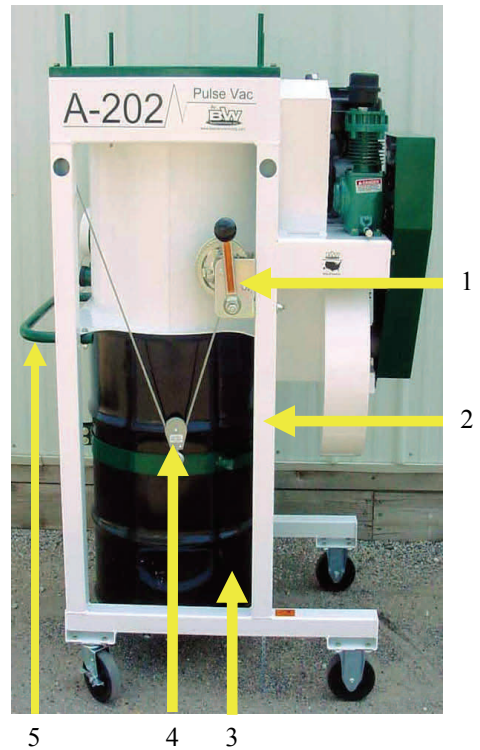

# V1900 GAS VAC PARTS BODY GROUP

- 1. W-0023 Pulley
- 2. W-31-AS Intake Pipe
- 3. I-147-AS Cap 5"
- 4. W-0016 Cap 2"
- 5. I-163 Lanyard
- 6. W-27-AS Drum Strap
- 7. W-49 Lid seal (*not shown*)
- 8. W-50 Drum deal (*not shown*)

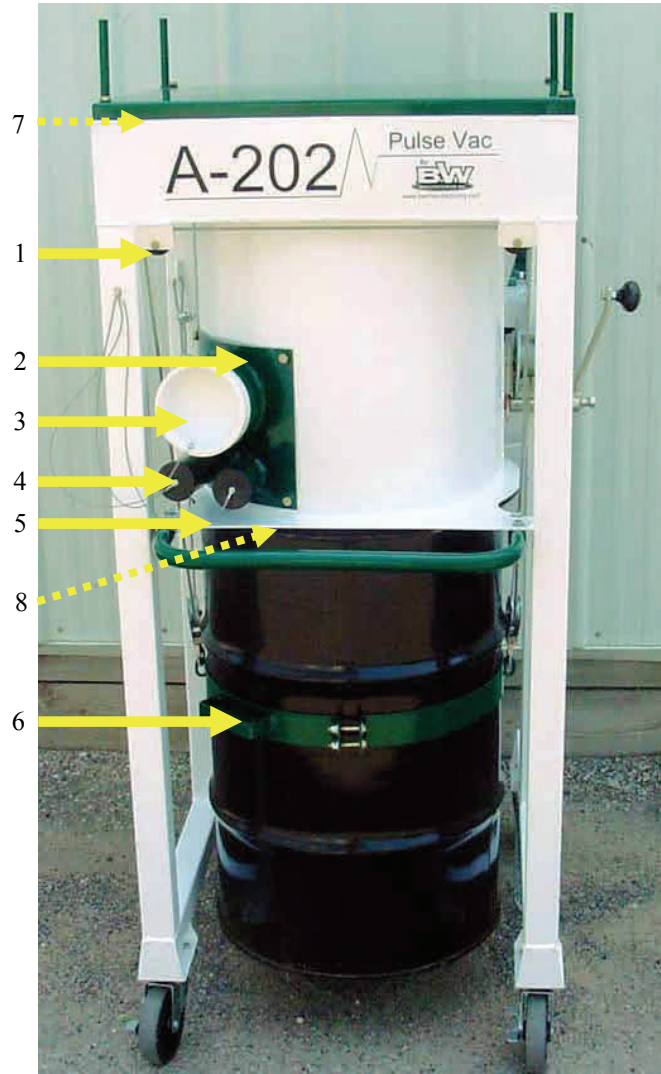

- 1. W-34-AS Dust Deflector
- 2. 10129-B Filter (blend)
- 10129-D Filter (moisture resistant) (optional)
- 10129-H Filter (HEPA) (optional - *special order*)
- 3. V-122-AS Filter Nut

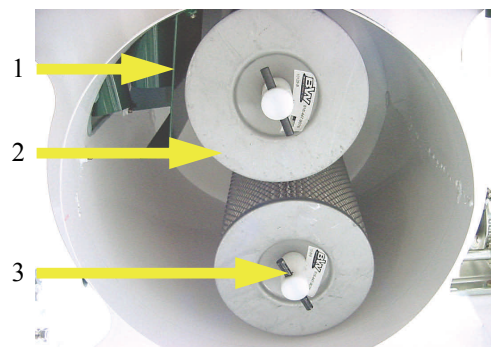

# V1900 GAS VAC PARTS BODY GROUP

- 1. I-127 Motor Sheave (Gas)
- R-117 Motor Sheave (220V)
- 2. I-126 Idler Pulley
- 3. D-1311 Belt Tensioner
- 4. W-0027 Belt
- 5. I-128-A Blower Sheave
- 6. W-37-AS Blower Mount

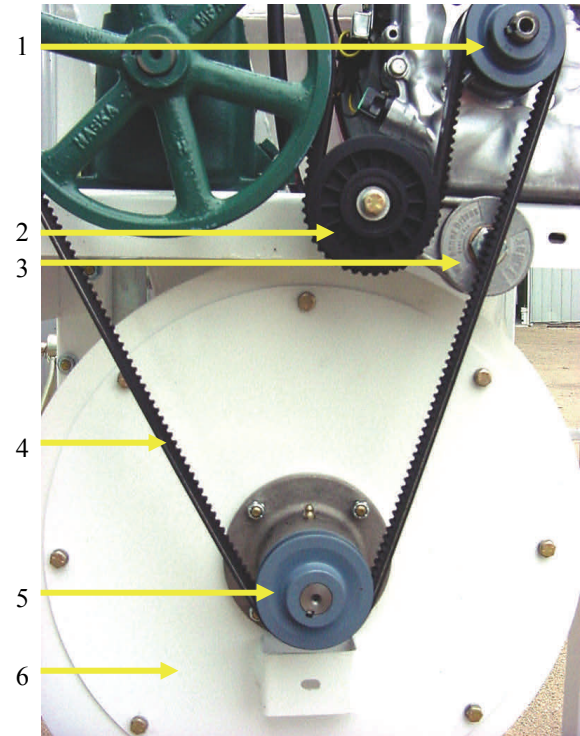

- 1. D-1205 Blower Fan
- 2. 1/4-20X1 Blower Fan Bolt
- 3. R-36 Blower Hub
- 4. D-1290 Blower Fan Bearing
- 5. D-1309 Blower Fan Main Shaft Snap Ring
- 6. O-02-V Blower Fan Main Shaft

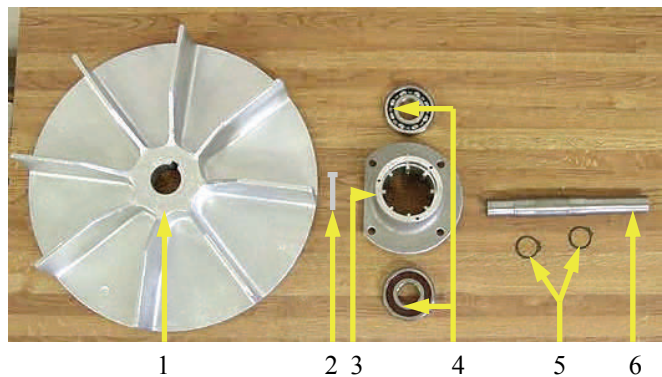

# V1900 GAS VAC PARTS AIR GROUP

- 1. I-144-FH Compressor Air Filter Housing (includes Air Filter)
- 2. I-144-FE Compressor Air Filter *(not shown)*
- 3. I-144 Air Compressor
- 4. I-102-A Air Compressor Sheave

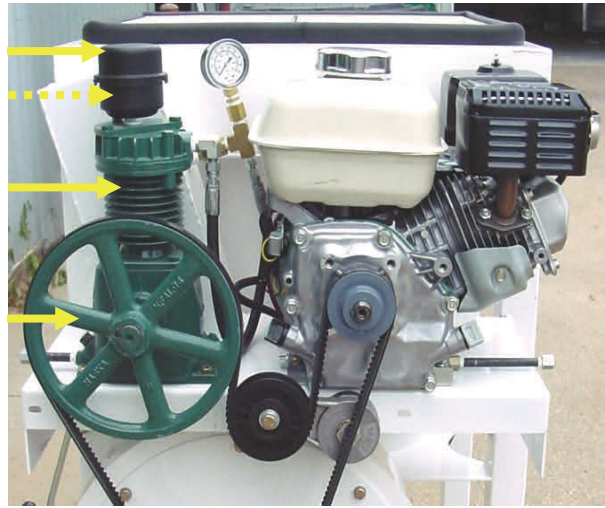

- 1. V-1022 Pressure Gauge
- 2. I-106 Fitting
- 3. I-154 Snubber
- 4. I-154-B Snubber Filter
- 5. C-1645 Adapter
- 6. V-1039 Pipe Nipple
- 7. C-1776 Compressor Fitting
- 8. W-59 Air Compressor Air Line
- 9. C-1764 Adapter

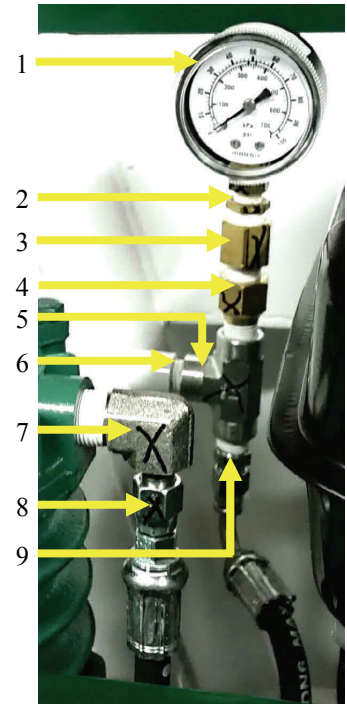

- 1. C-1623 Pressure Relief Valve
- 2. W-0006 Adapter
- 3. V-1039 Pipe Nipple
- 4. V-1031 Fitting (90 Degree)

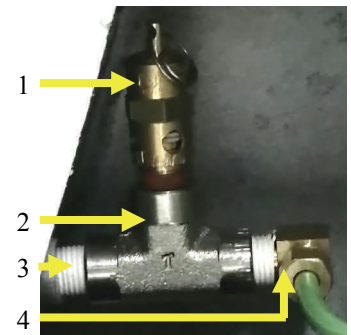

# V1900 GAS VAC PARTS AIR GROUP

1. W-0031 Low Pressure Unloader Valve
2. W-0032 High Pressure Unloader Valve
3. W-0008 Pilot Valve

Unit can be purchased as an assembly using part number **W-0008-AS**

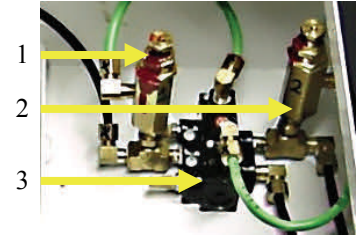

1. W-18-1AS Air Tank
2. W-52 Popet Valve
3. V-1031 Air Fitting (90 deg.)

*5 Bolt Poppet Valve & Tank*

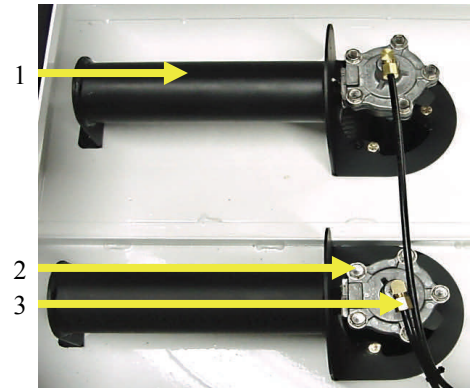

*5 Bolt Poppet Valve*

1. V-1019 Orifice Bushing
2. W-52 Popet Valve
3. W-53 Popet Valve Repair Kit

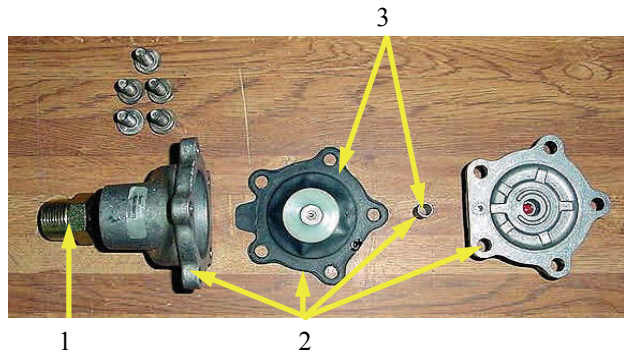

# V1900 GAS VAC PARTS AIR GROUP

1. W-18-1AS Air Tank
2. V-1013 Popet Valve
3. V-1031 Air Fitting (90 deg.)

4 Bolt Poppet Valve

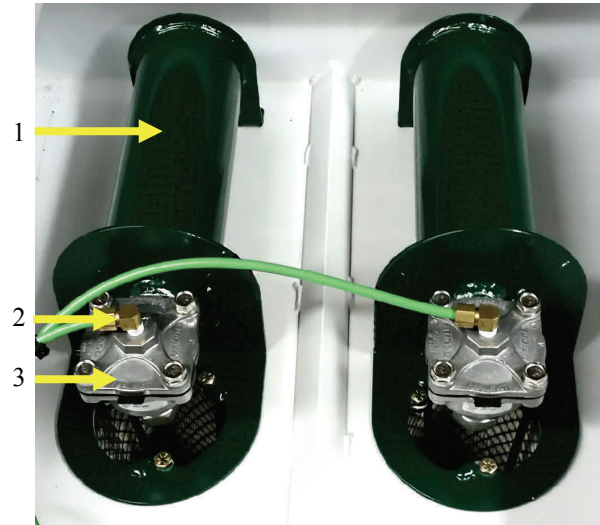

- 4 Bolt Poppet Valve
1. V-1019 Orifice Bushing
  2. V-1013 Popet Valve
  3. V-1107 Popet Valve Repair Kit

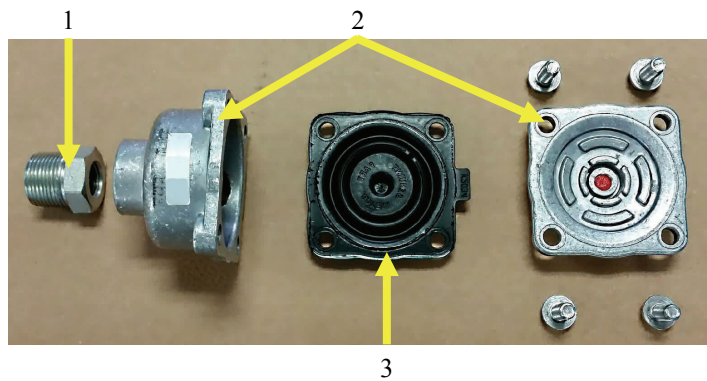

# V1900 GAS VAC ADDITIONAL SPARE PARTS

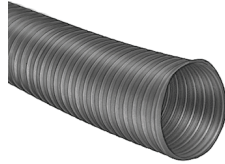

**I-122**  
5" x 15' Vac Hose



**V-1084**  
2" x 15' Vac Hose



**10129-B**  
Filter (Blend) (Standard)  
99.7% Efficiency @ .05 Microns

**10129-D**  
Moisture Resistant (Optional)  
99% Efficiency @ 1-2 Microns

**10129-H**  
HEPA (*Special Order*)  
99.995% Efficiency @ .03 Microns



**W-0002**  
30 Gallon Drum Liner (4 mil)



Proposition 65  
State of California

Warning !

Engine exhaust and some its constituents are known to the State of California to cause cancer, birth defects, and/or other reproductive harm.

Notification of Spark Arrester Requirement for  
State of California

It is a violation of Section 4442 or 4443 to use or operate the engine on any forest-covered, brush-covered, or grass-covered land unless the engine is equipped with a spark arrester, as defined in Section 4442, maintained in effective working order or the engine is constructed, equipped, and maintained for the prevention of fire pursuant to Section 4443.

## **EQUIPMENT AND PARTS WARRANTY**

Diamond Products warrants all equipment manufactured by it against defects in workmanship or materials for a period of one (1) year from the date of shipment to Customer.

The responsibility of Diamond Products under this Warranty is limited to replacement or repair of defective parts at Diamond Products' Elyria, Ohio factory, or at a point designated by it, of such parts as shall appear to us upon inspection at such parts, to have been defective in material or workmanship, with expense for transportation and labor borne by Customer.

In no event shall Diamond Products be liable for consequential or incidental damages arising out of the failure of any Product to operate properly.

Integral units such as engines, electric motors, batteries, transmissions, etc., are excluded from this Warranty and are subject to the prime manufacturer's warranty.

**THIS WARRANTY IS IN LIEU OF ALL OTHER WARRANTIES, EXPRESSED OR IMPLIED, AND ALL SUCH OTHER WARRANTIES ARE HEREBY DISCLAIMED.**



333 Prospect Street, Elyria, Ohio 44035  
(440) 323-4616 • (800) 321-5336 • Fax (440) 323-8689  
[www.diamondproducts.com](http://www.diamondproducts.com)