

CARE AND OPERATION INSTRUCTIONS

SLDVT Direct-Vent Gas Fireplaces

MODELS		MILLIVOLT:	ELECTRONIC:
SLDVT-30NM	SLDVT-40NM	SLDVT-30NE	SLDVT-35NE
SLDVT-30PM	SLDVT-40PM	SLDVT-40NE	SLDVT-45NE
SLDVT-35NM	SLDVT-45NM	SLDVT-45NE	
SLDVT-35PM	SLDVT-45PM		

WHAT'S INSIDE	
Table of Contents	2
Safety and Your Fireplace	2
FREE Safety Guard Offer (Protects Against Burns)	2
Important Safety Information	4
Attaching the Safety-in-Operation Warnings	5
[EN FRANÇAIS] L'information de sûreté importante	3-4
Apposition des mises en garde relatives à la sécurité d'utilisation	5
[EN ESPAÑOL] Información importante de seguridad	3-4
Colocación de advertencias de seguridad en operación	5



Intertek

Report No. 100353019PRT-001



INSTALLER: Leave this manual with the appliance.
CONSUMER: Retain this manual for future reference.
INSTALLATEUR : Laissez cette notice avec l'appareil.
CONSOMMATEUR : Conservez cette notice pour consultation ultérieure.

! WARNING / AVERTISSEMENT / AVISO

<ul style="list-style-type: none"> • HOT GLASS WILL CAUSE BURNS. • DO NOT TOUCH GLASS UNTIL COOLED. • NEVER ALLOW CHILDREN TO TOUCH GLASS. 		<ul style="list-style-type: none"> • UNE SURFACE VITRÉE CHAUDE PEUT CAUSER DES BRÛLURES. • LAISSER REFROIDIR LA SURFACE VITRÉE AVANT D'Y TOUCHER. • NE PERMETTEZ JAMAIS À UN ENFANT DE TOUCHER LA SURFACE VITRÉE. 	<ul style="list-style-type: none"> • EL VIDRIO CALIENTE CAUSARÁ QUEMADURAS. • USTED DEBE NUNCA TOCAR EL VIDRIO CALIENTE. • LOS NIÑOS DEBEN NUNCA TOCAR EL VIDRIO.
---	--	--	--

WARNING: If the information in these instructions is not followed exactly, a fire or explosion may result, causing property damage, personal injury, or death.

- Do not store or use gasoline or other flammable vapors and liquids in the vicinity of this or any other appliance.
- **WHAT TO DO IF YOU SMELL GAS:**
 - Do not try to light any appliance.
 - Do not touch any electrical switch; do not use any phone in your building.
 - Immediately call your gas supplier from a neighbor's phone. Follow the gas supplier's instructions.
 - If you cannot reach your gas supplier, call the fire department.
- Installation and service must be performed by a qualified installer, service agency or the gas supplier.

AVERTISSEMENT : Assurez-vous de bien suivre les instructions données dans cette notice pour réduire au minimum le risque d'incendie ou d'explosion ou pour éviter tout dommage matériel, toute blessure ou la mort.

- Ne pas entreposer ni utiliser d'essence ni d'autres vapeurs ou liquides inflammables dans le voisinage de cet appareil ou de tout autre appareil.
- **QUE FAIRE SI VOUS SENTEZ UNE ODEUR DE GAZ :**
 - Ne pas tenter d'allumer d'appareil.
 - Ne touchez à aucun interrupteur. Ne pas vous servir des téléphones se trouvant dans le bâtiment où vous trouvez.
 - Appelez immédiatement votre fournisseur de gaz depuis un voisin. Suivez les instructions du fournisseur.
 - Si vous ne pouvez rejoindre le fournisseur de gaz, appelez le service des incendies.
- L'installation et l'entretien doivent être assurés par un installateur ou un service d'entretien qualifié ou par le fournisseur de gaz.

Unit Shipping Weights/Volumes			
Cat. No.	Model	Ship. Weight	Ship. Volume
H7496	SLDVT-30NM	78 lbs.	9.09 cu. ft.
H7497	SLDVT-30PM	78 lbs.	9.09 cu. ft.
H7498	SLDVT-30NE	78 lbs.	9.09 cu. ft.
H7282	SLDVT-35NM	86 lb.	10.61 cu. ft.
H7284	SLDVT-35PM	86 lb.	10.61 cu. ft.
H7286	SLDVT-35NE	86 lb.	10.61 cu. ft.
H7283	SLDVT-40NM	108 lb.	14.01 cu. ft.
H7285	SLDVT-40PM	108 lb.	14.01 cu. ft.
H7287	SLDVT-40NE	108 lb.	14.01 cu. ft.
H7499	SLDVT-45NM	122 lbs.	15.76 cu. ft.
H7500	SLDVT-45PM	122 lbs.	15.76 cu. ft.
H7501	SLDVT-45NE	122 lbs.	15.76 cu. ft.

ACCESSORY COMPONENTS



Digital Wall Thermostat

The wall thermostat kit provides temperature control for optimum comfort.

Wall Thermostat, Millivolt		
Cat. No.	Model No.	Description
H4635	DWTK	Wall Thermostat Kit, White

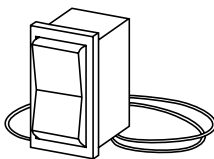

Unit-Mountable Rocker Switch

This rocker switch kit can be installed directly in the gas valve mounting bracket (millivolt gas valve equipped fireplaces) to provide On/Off operation in lieu of a wall switch.

Rocker Switch Kit		
Cat. No.	Model No.	Description
80L41	FRS	Rocker Switch Kit



Standard Remote Control System

The Model RCL (Standard) Remote Control System, features a simplistic OFF/ON control function for the fireplace. This model includes a hand-held transmitter, a remote receiver with wall-mount cover plate and all hardware required to install the unit. The remote receiver can be wall or hearth mounted.

The transmitter has ON and OFF functions that are activated by pressing either button on the face of the transmitter. When a button on the transmitter is pressed, a signal light illuminates briefly to verify that a signal has been sent.

The Model RCL is designed to operate with all millivolt ignition systems, as well as electronic ignition systems. It may be installed with use for either natural gas or propane gas appliances. The RCL offers ease of installation and allows you to execute on-off commands to the fireplace effortlessly with one simple motion.

The Model RCL comes complete with detailed operating instructions.

Remote Control Kit, Standard		
Cat. No.	Model No.	Description
H0249	RCL	Remote Control System (Standard)

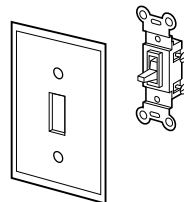

OFF/ON Wall Switch Kit

The OFF/ON wall switch kit may be used to control the operation of the fireplace burner or blower. Install the OFF/ON wall switch in a convenient location near the fireplace.

White Wall Switch Kit		
Cat. No.	Model No.	Description
85L87	FWSK	OFF/ON Wall Switch Kit



Deluxe Remote Control System

The Model RCL-T (Deluxe) Remote Control System has all of the features of the standard system along with an added easy to read LCD screen which presents access to many enhancements, including; battery power level indicator, timer, mode of operation, thermostatic display including room temperature in either metric or English units, flame indicator and clock. Fully programmable, the Model RCL-T allows for virtual command over nearly all operational and temperature variables, using the hand held remote control transmitter.

The Model RCL-T (Deluxe) remote control system is installed in the same manner as the standard system, may be operated with electronic and millivolt systems with either natural gas or propane gas. The RCL-T comes complete with detailed operating instructions.

Remote Control Kit, Deluxe		
Cat. No.	Model No.	Description
H0251	RCL-STAT	Remote Control System (Deluxe)

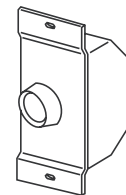

Variable Speed Wall Switch

Provides variable speed control if optional blower kit is purchased.

Variable Speed Wall Switch		
Cat. No.	Model No.	Description
045571H	VSWK	Rocker Switch Kit

ACCESSORY COMPONENTS (continued)

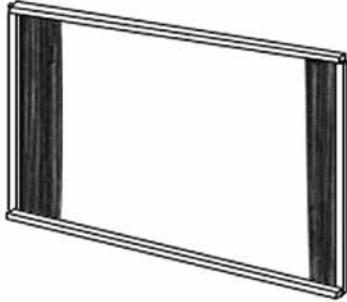

Pull Screen Panel Kit

This easy to install optional decorative screen kit installs over the standard glass enclosure panel. These screen kits cannot be used in conjunction with the arch door kits or door frame kits.

Screen Panel Kits		
Cat. No.	Model No.	Models Where Used
H6112	PSFPKM30	SLDVT-30
H6113	PSFPKM35	SLDVT-35
H6114	PSFPKM40	SLDVT-40
H6115	PSFPKM45	SLDVT-45

Style View Screen Doors -

These Style View doors are easy to install and will not require hardware to attach them to the standard glass door frame. The Style View door installs over the standard glass enclosure panel and provides a barrier to prevent direct contact with the hot glass surface. The door includes heavy duty magnet door latches and functional twin-pane screen doors.

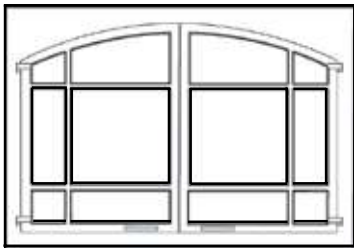

Arch Pane Design

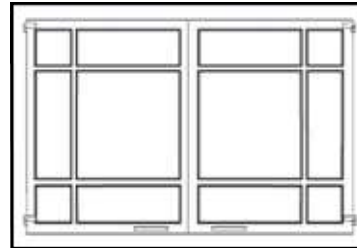

Square Pane Design

ARCH PANE DESIGN KITS			
Cat. No.	Model	Description	Model Series
H6104	APDML30C	30" Arch Pane Door, Painted	SLDVT-30
H6105	APDML30SP	30" Arch Pane Door, Satin Pewter	
H6106	APDML35C	35" Arch Pane Door, Painted	SLDVT-35
H6107	APDML35SP	35" Arch Pane Door, Satin Pewter	
H6108	APDML40C	40" Arch Pane Door, Painted	SLDVT-40
H6109	APDML40SP	40" Arch Pane Door, Satin Pewter	
H6110	APDML45C	45" Arch Pane Door, Painted	SLDVT-45
H6111	APDML45SP	45" Arch Pane Door, Satin Pewter	

SQUARE PANE DESIGN KITS			
Cat. No.	Model	Description	Model Series
H6096	SPDML40C	30" Square Pane Door, Painted	SLDVT-30
H6097	SPDML40SP	30" Square Pane Door, Satin Pewter	
H6098	SPDML35C	35" Square Pane Door, Painted	SLDVT-35
H6099	SPDML35SP	35" Square Pane Door, Satin Pewter	
H6100	SPDML40C	40" Square Pane Door, Painted	SLDVT-40
H6101	SPDML40SP	40" Square Pane Door, Satin Pewter	
H6102	SPDML45C	45" Square Pane Door, Painted	SLDVT-45
H6103	SPDML45SP	45" Square Pane Door, Satin Pewter	

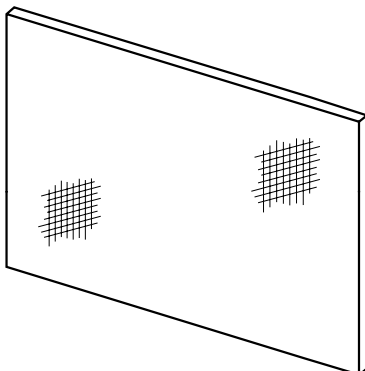

Barrier Screen Panel Kit

This easy to install optional screen panel installs over the standard glass enclosure panel and provides a barrier to prevent direct contact with the hot glass surface. These screen panels cannot be used in conjunction with the arch door kits or door frame kits.

Barrier Screen Panel Kits		
Cat. No.	Model No.	Models Where Used
H6094	30MSKP	SLDVT-30
H6095	35MSPK	SLDVT-35
H3989	40LSPK	SLDVT-40
H3990	45LSPK	SLDVT-45

ACCESSORY COMPONENTS (continued)

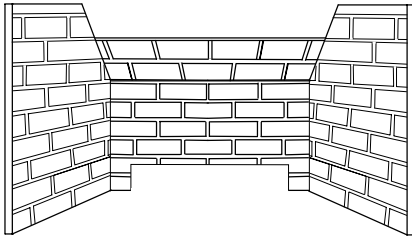

Brickaded Panel Liner Kit

The brickaded liner kits include ceramic panels as shown here. The panels have brick-like features in relief.

Brickaded Wall Liner Kits		
Cat. No.	Model No.	Description
H7502	BLPK-30TB	Brick Liner Kit, Buff SLDVT-30
H7288	BLPK-35TB	Brick Liner Kit, Buff SLDVT-35
H7289	BLPK-40TB	Brick Liner Kit, Buff SLDVT-40
H7503	BLPK-45TB	Brick Liner Kit, Buff SLDVT-45
H7505	BLPK-30TR	Brick Liner Kit, Red SLDVT-30
H7290	BLPK-35TR	Brick Liner Kit, Red SLDVT-35
H7291	BLPK-40TR	Brick Liner Kit, Red SLDVT-40
H7505	BLPK-45TR	Brick Liner Kit, Red SLDVT-45



Touch-Up Paint Kit

Repair of minor scratches and discoloration of the appliance black painted surfaces may be accomplished with the touch-up paint kit.

Touch-Up Paint Kits (all models)		
Cat. No.	Model No.	Description
90L73	FTPK-B	Touch-Up Paint (Black)

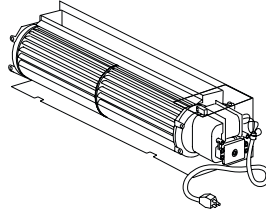

Forced Air Kit

The FBK-100 blower provides constant velocity forced air circulation. The FBK-200 assembly with variable speed, wall-mountable switch provides variable speed forced air circulation. The FBK-300 features and automatic thermo-sensitive control.

Forced Air Blower Kits		
Cat. No.	Model No.	Description
80L84	FBK-100	Blower, Standard (single speed)
80L85	FBK-200	Blower, Variable Speed (w/wall-mounted switch)
H7841	FBK-300	Blower, Variable Speed (w/thermal snap switch)



**Bag of Glowing Embers
Bag of Volcanic Stone**

Replacement ember materials or volcanic stone are available for use with these appliances. Order kits as part of the periodic maintenance of the appliance.

Decorative Firebox Accessories (all models)		
Cat. No.	Model No.	Description
88L53	FGE	Bag of Glowing Embers
80L42	FDVS	Bag of Decorative Volcanic Stone

Termination Shroud (Fits H1968)

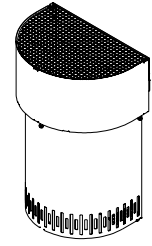

Deluxe Termination Guard (Fits 94L10)

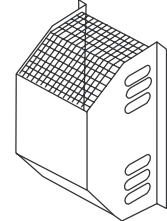

Square Termination Guard (Fits 94L10)

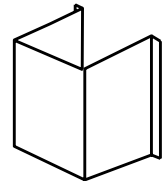

Termination Guard Kits

The vent termination guards may be used to cover the vent termination on the exterior of the home to minimize exposure to the hot surface of the termination.

Termination Guard Kits (all models)		
Cat. No.	Model No.	Description
H5820	4.5HTSK	Termination Shroud
87L02	SV4.5HGS	Termination Guard, Deluxe
17M52	SV4.5HGS-1	Termination Guard, Square

REPLACEMENT PARTS LIST

Item No.	Description	SLDVT-30		SLDVT-35		SLDVT-40		SLDVT-45	
		Part No.	Qty.	Part No.	Qty.	Part No.	Qty.	Part No.	Qty.
1	Hood	H7568	1	H7266	1	H7267	1	H7569	1
2	Lower Control Compartment Panel	H7556	1	H7262	1	H7263	1	H7557	1
3	Enclosure, Glass Front (Complete)	H7560	1	H7264	1	H7265	1	H7561	1
4	Door Latch Spring	H1264	2	H1264	2	H1264	2	H1264	2
5	Log Set (Complete)	H7244	1	H7244	1	H7245	1	H7547	1
6	Burner Assembly	H7258	1	H7253	1	H7259	1	H7550	1
7	Orifice, Main Burner - Natural Gas	H4873	1	H1355	1	60J80	1	37L70	1
7	Orifice, Main Burner - Propane Gas	35M91	1	75L10	1	99K78	1	99K79	1
8	Bag of Glowing Embers (Rockwool)	88L53	1	88L53	1	88L53	1	88L53	1
8	Bag of Decorative Volcanic Stone	80L42	1	80L42	1	80L42	1	80L42	1
9	Orifice Holder	H7257	1	H7257	1	H7257	1	H7257	1
10	Gas Line Flexible Connector	93L32	1	93L32	1	93L32	1	93L32	1
11	Sub-Floor	H7558	1	H7450	1	H7462	1	H7741	1

Gas Controls - SIT Millivolt

Item No.	Description	Natural Gas		Propane Gas	
		Part No.	Qty.	Part No.	Qty.
15	Gas Valve, SIT	H6209	1	88J53	1
16	Piezo Igniter	10K86	1	10K86	1
---	Piezo Igniter Wire	56L21	1	56L21	1
17	Pilot Assembly	69L17	1	69L18	1
18	Pilot Generator	60J79	1	60J79	1
19	Thermocouple	74L57	1	74L57	1
20	Pilot Tube	74L56	1	74L56	1
21	Electrode and Cable	74L58	1	74L58	1

Gas Controls - Dexen Electronic

Item No.	Description	Natural Gas	
		Part No.	Qty.
28	Gas Valve, Dexen	H4681	1
29	Pilot Assembly	H4673	1
30	Igniter Module	H4674	1
31	Battery Holder	H4675	1
32	Wire Harness	H4676	1
33	Adaptor	H4677	1

Contact an Authorized Lennox Hearth Products dealer to obtain any of these parts. Never use substitute materials. Use of non-approved parts can result in poor performance and safety hazards.

WARNING

Failure to position the parts in accordance with these diagrams or failure to use only parts specifically approved with this appliance may result in property damage or personal injury.

AVERTISSEMENT

Risque de dommages ou de blessures si les pièces ne sont pas installées conformément à ces schémas et ou si des pièces autres que celles spécifiquement approuvées avec cet appareil sont utilisées.

REPLACEMENT PARTS

