





HEARTH PRODUCTS

	⚠ WARNINGS <ul style="list-style-type: none">• Hot! Do not touch! The glass and surfaces of this appliance will be hot during operation and will retain heat for a while after shutting off the appliance. Severe burns may result.• Carefully supervise children in the same room as appliance.
	<ul style="list-style-type: none">• If small children are present in the home, it is recommended that this appliance be fitted with a screen door or screen panel kit. See <i>Pages 13 & 14</i> for ordering information.

WARNING: IF THE INFORMATION IN THIS MANUAL IS NOT FOLLOWED EXACTLY, A FIRE OR EXPLOSION MAY RESULT CAUSING PROPERTY DAMAGE, PERSONAL INJURY OR LOSS OF LIFE.

Do not store or use gasoline or other flammable vapors or liquids in the vicinity of this or any other appliance.

WHAT TO DO IF YOU SMELL GAS:

- Do not light any appliance.
- Do not touch any electrical switch; do not use any phone in your building.
- Immediately call your gas supplier from a neighbor's phone. Follow your gas supplier's instructions.
- If your gas supplier cannot be reached, call the fire department.

Installation and service must be performed by a qualified installer, service agency or the gas supplier.

Tested & Listed By  Beaverton Oregon USA
OMNI-Test Laboratories, Inc.

OTL Report No. 116-F-31-5

A French manual is available upon request. Order P/N 875,028CF
Ce manuel d'installation est disponible en français, simplement en faire la demande. Numéro de la pièce 875,028CF

CARE AND OPERATION INSTRUCTIONS

DIRECT VENT MERIT™ LMDV-33/35/40 SERIES

DIRECT-VENT GAS FIREPLACE HEATERS

P/N 875,028M REV. E 02/2008

MODELS

Millivolt Models

LMDVT-3328CNM

LMDVT-3328CPM

LMDVR-3328CNM

LMDVR-3328CPM

Electronic Models

LMDVT-3328CNE

LMDVR-3328CNE

LMDV-3530CNE

LMDV-4035CNE

INSTALLER: Leave this manual with the appliance.
CONSUMER: Retain this manual for future reference.

AVERTISSEMENT: ASSUREZ-VOUS DE BIEN SUIVRE LES INSTRUCTIONS DONNÉ DANS CETTE NOTICE POUR RÉDUIRE AU MINIMUM LE RISQUE D'INCENDIE OU POUR ÉVITER TOUT DOMMAGE MATÉRIEL, TOUTE BLESSURE OU LA MORT.

POUR VOTRE SÉCURITÉ: Ne pas entreposer ni utiliser d'essence ni d'autre vapeurs ou liquides inflammables dans le voisinage de cet appareil ou de tout autre appareil.

POUR VOTRE SÉCURITÉ: Que faire si vous sentez une odeur de gaz:

- Ne pas tenter d'allumer d'appareil.
- Ne touchez à aucun interrupteur. Ne pas vous servir des téléphones se trouvant dans le bâtiment où vous vous trouvez.
- Evacuez la pièce, le bâtiment ou la zone.
- Appelez immédiatement votre fournisseur de gaz depuis un voisin. Suivez les instructions du fournisseur.
- Si vous ne pouvez rejoindre le fournisseur de gaz, appelez le service des incendies.

L'installation et service doit être exécuté par un qualifié installateur, agence de service ou le fournisseur de gaz.

ACCESSORY COMPONENTS

Product Reference Information			
Cat. No.	Model	Ship. Weight	Ship. Volume
H3313	LMDVT-3328CNM	95 lb.	13.08 cu. ft.
H3314	LMDVT-3328CPM	95 lb.	13.08 cu. ft.
H3315	LMDVR-3328CNM	95 lb.	13.08 cu. ft.
H3316	LMDVR-3328CPM	95 lb.	13.08 cu. ft.
H3317	LMDVT-3328CNE	95 lb.	13.08 cu. ft.
H3318	LMDVR-3328CNE	95 lb.	13.08 cu. ft.
H3319	LMDV-3530CNM	113 lb.	15.75 cu. ft.
H3320	LMDV-3530CPM	113 lb.	15.75 cu. ft.
H3321	LMDV-3530CNE	113 lb.	15.75 cu. ft.
H3322	LMDV-4035CNM	147 lb.	20.18 cu. ft.
H3323	LMDV-4035CPM	147 lb.	20.18 cu. ft.
H3324	LMDV-4035CNE	147 lb.	20.18 cu. ft.



Digital Wall Thermostat

The wall thermostat kit provides temperature control for optimum comfort.

Wall Thermostat, Millivolt		
Cat. No.	Model No.	Description
H4635	DWTK	Wall Thermostat Kit, White

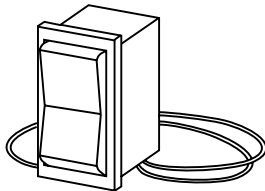

Unit-Mountable Rocker Switch

This rocker switch kit can be installed directly in the gas valve mounting bracket (millivolt gas valve equipped fireplaces) to provide On/Off operation in lieu of a wall switch.

Rocker Switch Kit		
Cat. No.	Model No.	Description
80L41	FRS	Rocker Switch Kit

(ref. Form # 750,037M)



Standard Remote Control System

The Model RCL (Standard) Remote Control System, features a simplistic OFF/ON control function for the fireplace. This model includes a hand-held transmitter, a remote receiver with wall-mount cover plate and all hardware required to install the unit. The remote receiver can be wall or hearth mounted.

The transmitter has ON and OFF functions that are activated by pressing either button on the face of the transmitter. When a button on the transmitter is pressed, a signal light illuminates briefly to verify that a signal has been sent.

The Model RCL is designed to operate with all millivolt ignition systems, as well as electronic ignition systems. It may be installed with use for either natural gas or propane gas appliances. The RCL offers ease of installation and allows you to execute on-off commands to the fireplace effortlessly with one simple motion.

The Model RCL comes complete with detailed operating instructions.

Remote Control Kit, Standard		
Cat. No.	Model No.	Description
H0249	RCL	Remote Control System (Standard)

(ref. Form # 750,127M)

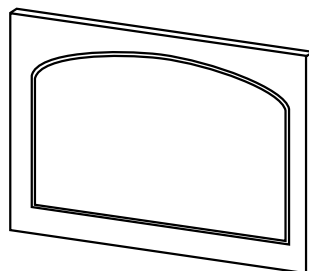

Arch Door Kits

The arch door kits are easy to install and do not require hardware to attach them to the standard door frame. The decorative arch kits can not be used in conjunction with the screen panel kit.



Deluxe Remote Control System

The Model RCL-T (Deluxe) Remote Control System has all of the features of the standard system along with an added easy to read LCD screen which presents access to many enhancements, including; battery power level indicator, timer, mode of operation, thermostatic display including room temperature in either metric or English units, flame indicator and clock. Fully programmable, the Model RCL-T allows for virtual command over nearly all operational and temperature variables, using the hand held remote control transmitter.

The Model RCL-T (Deluxe) remote control system is installed in the same manner as the standard system, may be operated with electronic and millivolt systems with either natural gas or propane gas. The RCL-T comes complete with detailed operating instructions.

Remote Control Kit, Deluxe		
Cat. No.	Model No.	Description
H0251	RCL-STAT	Remote Control System (Deluxe)

(ref. Form # 750,129M)

Arch Door Kit - Polished Brass		
Cat. No.	Model	Fireplace Model
98L05	ADK33CPB	LMDVT-3328, LMDVR-3328
26M43	ADK35CMPB	LMDV-3530
81L35	ADK40CPB	LMDV-4035

Arch Door Kit - Brushed Stainless Steel		
Cat. No.	Model	Fireplace Model
98L62	ADK33CBS	LMDVT-3328, LMDVR-3328
26M44	ADK35CMBS	LMDV-3530
98L69	ADK40CBS	LMDV-4035

(ref. Form # 750,021M)

ACCESSORY COMPONENTS

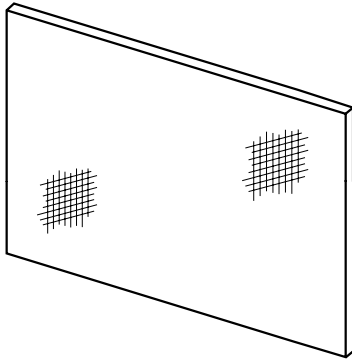

Barrier Screen Panel Kit

This easy to install optional screen panel installs over the standard glass enclosure panel and provides a barrier to prevent direct contact with the hot glass surface. These screen panels cannot be used in conjunction with the arch door kits or door frame kits.

Screen Panel Kits		
Cat. No.	Model No.	Models Where Used
98L04	HG33	LMDVT-3328 LMDVR-3328
26M48	HG35M	LMDV-3530
26M49	HG40M	LMDV-4035

(ref. Form # 750,101M)

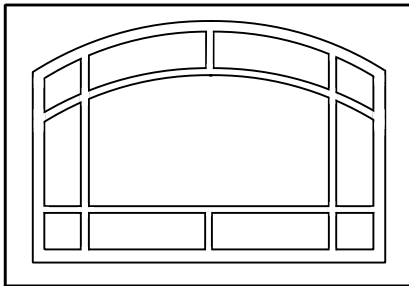

Decorative Arch Screen Panel Kit

This easy to install optional screen panel installs over the standard glass enclosure panel and provides a barrier to prevent direct contact with the hot glass surface. These screen panels cannot be used in conjunction with the arch door kits or door frame kits.

Decorative Arch Screen Panel Kit			
Cat. No.	Model	Model	Model Series
H3592	DASPK33TI	33" Decorative Arch Screen Panel	LMDVT-3328 & LMDVR-3328
H3593	DASPK35TI	35" Decorative Arch Screen Panel	LMDV-3530
H3594	DASPK40TI	40" Decorative Arch Screen Panel	LMDV-4035

(ref. Form # 750,199M)

Style View™ Doors - Arch Design Kits			
Cat. No.	Model	Model	Model Series
H0858	AD35C	35" Arch Doors, Charcoal	LMDV-3530
H0859	AD35TI	35" Arch Doors, Textured Iron	
H0860	AD35SP	35" Arch Doors, Satin Pewter	
H0861	AD35AB	35" Arch Doors, Antique Brass	
H0862	AD40C	40" Arch Doors, Charcoal	LMDV-4035
H0863	AD40TI	40" Arch Doors, Textured Iron	
H0864	AD40SP	40" Arch Doors, Satin Pewter	
H0865	AD40AB	40" Arch Doors, Antique Brass	

Style View Doors - Arch Pane Design Kits			
Cat. No.	Model	Model	Model Series
H0930	APD35C	35" Arch Pane Doors, Charcoal	LMDV-3530
H0931	APD35TI	35" Arch Pane Doors, Textured Iron	
H0932	APD35SP	35" Arch Pane Doors, Satin Pewter	
H0933	APD35AB	35" Arch Pane Doors, Antique Brass	
H0934	APD40C	40" Arch Pane Doors, Charcoal	LMDV-4035
H0935	APD40TI	40" Arch Pane Doors, Textured Iron	
H0936	APD40SP	40" Arch Pane Doors, Satin Pewter	
H0937	APD40AB	40" Arch Pane Doors, Antique Brass	

Style View Doors - Square Design Kits			
Cat. No.	Model	Model	Model Series
H0946	SD35C	35" Sq. Doors, Charcoal	LMDV-3530
H0947	SD35TI	35" Sq. Doors, Textured Iron	
H0948	SD35SP	35" Sq. Doors, Satin Pewter	
H0949	SD35AB	35" Sq. Doors, Antique Brass	
H0950	SD40C	40" Sq. Doors, Charcoal	LMDV-4035
H0951	SD40TI	40" Sq. Doors, Textured Iron	
H0952	SD40SP	40" Sq. Doors, Satin Pewter	
H0953	SD40AB	40" Sq. Doors, Antique Brass	

Style View Doors - Square Pane Design Kits			
Cat. No.	Model	Model	Model Series
H0962	SPD35C	35" Sq. Pane Doors, Charcoal	LMDV-3530
H0963	SPD35TI	35" Sq. Pane Doors, Textured Iron	
H0964	SPD35SP	35" Sq. Pane Doors, Satin Pewter	
H0965	SPD35AB	35" Sq. Pane Doors, Antique Brass	
H0966	SPD40C	40" Sq. Pane Doors, Charcoal	LMDV-4035
H0967	SPD40TI	40" Sq. Pane Doors, Textured Iron	
H0968	SPD40SP	40" Sq. Pane Doors, Satin Pewter	
H0969	SPD40AB	40" Sq. Pane Doors, Antique Brass	

(ref. Form # 775,169M)

Style View Screen Doors -

These Style View screen doors come in 4 beautiful styles. The Style View door installs over the standard glass enclosure panel and provides a barrier to prevent direct contact with the hot glass surface. The door includes heavy duty magnet door latches and functional twin-pane screen doors.

Arch Design

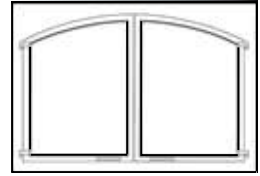

Arch Pane Design

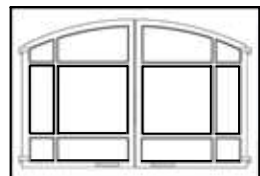

Square Design

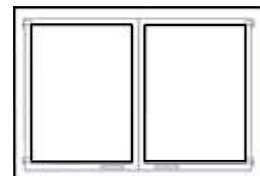

Square Pane Design

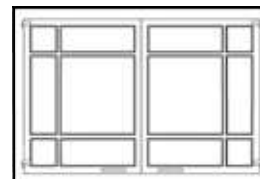

ACCESSORY COMPONENTS

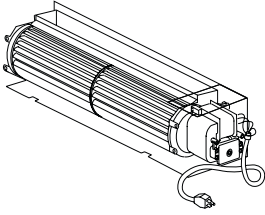

Forced Air Blower Kits		
Cat. No.	Model No.	Description
80L84	FBK-100	Blower, Standard (single speed)
80L85	FBK-200	Blower, Variable Speed (w/wall-mounted switch)
80L86	FBK-250	Blower, Variable Speed (w/unit-mounted switch)
94L89	FBK-100-36	Blower, Standard, 36 Pack
94L90	FBK-200-36	Blower Kit - Variable Speed with Wall Switch 36 Pack
H0543	FBK-250-36	Blower Kit - Variable Speed with Thermo Snap Switch 36 Pack

(ref. Form # 750,028M & 750,029M)

Forced Air Kit

The FBK-100 blower provides constant velocity forced air circulation. The FBK-200 assembly with variable speed, wall-mountable switch provides variable speed forced air circulation. The FBK-250 assembly with variable speed unit-mountable switch, also provides variable speed forced air circulation.

Variable Speed Wall Switch

Provides variable speed control if optional blower kit is purchased.

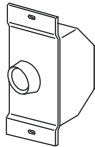

Variable Speed Wall Switch		
Cat. No.	Model No.	Description
045571H	VSWS	Rocker Switch Kit

Bag of Glowing Embers

Bag of Volcanic Stone

Replacement ember materials or volcanic stone are available for use with these appliances. Order kits as part of the periodic maintenance of the appliance.



Decorative Firebox Accessories (all models)		
Cat. No.	Model No.	Description
88L53	FGE	Bag of Glowing Embers (1 oz. rockwool)
80L42	FDVS	Bag of Decorative Volcanic Stone

(FDVS ref. Form #750,010M)

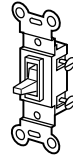
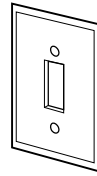

White Wall Switch Kit		
Cat. No.	Model No.	Description
85L87	FWSK	OFF/ON Wall Switch Kit

OFF/ON Wall Switch Kit

The OFF/ON wall switch kit may be used to control the operation of the fireplace burner. Install the OFF/ON wall switch in a convenient location near the fireplace.

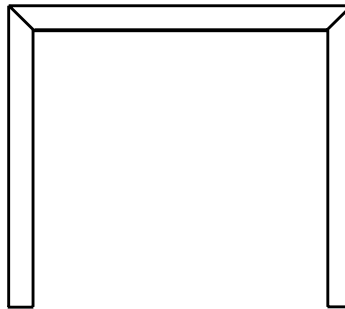

3 Piece Trim Kit		
Cat. No.	Model No.	Description
H0453	TK33PB3	33" Polished Brass, LMDVT-3328, LMDVR-3328
96K21	TK35PB3	35" Polished Brass, LMDV-3530
96K22	TK40PB3	40" Polished Brass, LMDV-4035
H1813	TK33BS3	33" Brushed Stainless, LMDVT-3328, LMDVR-3328
H1815	TK35BS3	35" Brushed Stainless, LMDV-3530
H1816	TK40BS3	40", Brushed Stainless, LMDV-4035
H4820	TK33C3	33" Charcoal, LMDVT-3328, LMDVR-3328
H4821	TK35C3	35" Charcoal, LMDV-3530
H4823	TK40C3	40" Charcoal, LMDV-4035

(ref. Form # 750,147M)

Polished Brass 3-Piece Trim Kit

This kit contains brass trim pieces used to finish the gaps between the wall board and the fireplace, providing the appliance a brass perimeter highlight. This kit contains the trim pieces and these instructions

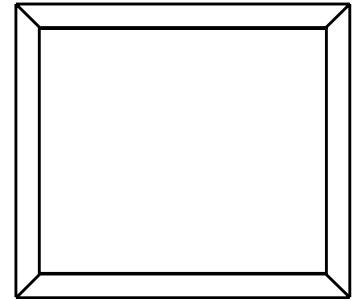

4 Piece Trim Kit		
Cat. No.	Model No.	Description
96K17	TK35PB4	35" 4 Piece Finish Trim Kit, Polished Brass, LMDV-3530
96K18	TK40PB4	40" 4 Piece Finish Trim Kit, Polished Brass, LMDV-4035

(ref. Form # ii-9299)

Polished Brass 4-Piece Trim Kit

This kit contains brass trim pieces used to finish the gaps between the wall board and the fireplace, providing the appliance a brass perimeter highlight. This kit contains the trim pieces and these instructions

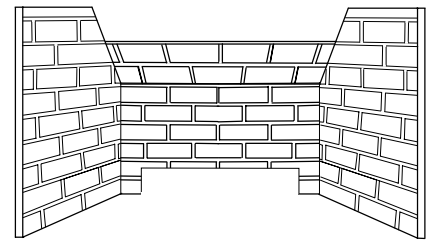

Brickaded Wall Liner Kits		
Cat. No.	Model No.	Description
H0912	MBLK-33T	Brick Liner Kit, Top Vent, LMDVT-3328
H0918	MBLK-33R	Brick Liner Kit, Rear Vent, LMDVR-3328
H0913	MBLK-35	Brick Liner Kit, Top/Rear, LMDV-3530
H0914	MBLK-40	Brick Liner Kit, Top/Rear, LMDV-4035

(ref. Form # 750,160M)

Brickaded Panel Liner Kit

The brickaded liner kits include ceramic panels as shown here. The panels have brick-like features in relief.

ACCESSORY COMPONENTS



Touch-Up Paint Kit

Repair of minor scratches and discoloration of the appliance charcoal painted surfaces may be accomplished with the touch-up paint kit.

Touch-Up Paint Kits (all models)		
Cat. No.	Model No.	Description
90L74	TPK-C	Touch-Up Paint (Charcoal)

(TPK-C ref. Form # 504,216M)

Termination Shroud

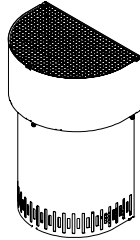

Deluxe Termination Guard

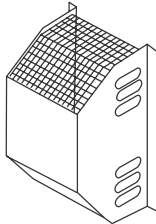

Square Termination Guard

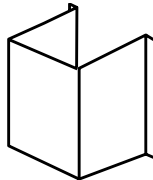

Termination Guard Kits (all models)		
Cat. No.	Model No.	Description
H5820	4.5HTSK	Termination Shroud
87L02	SV4.5HGS	Termination Guard, Deluxe
17M52	SV4.5HGS-1	Termination Guard, Square

Ref. 750,109M Ref. 750,055M

Termination Guard Kits

The vent termination guards may be used to cover the vent termination on the exterior of the home to minimize exposure to the hot surface of the termination.

* Assembled 8-Piece Louver Kits					
Polished Brass		Brushed Stainless		Models Where Used	
Cat. #	Model	Cat. #	Model		
H1522	LK-400B	H1523	LK-400BS	LMDVT-3328 LMDVR-3328	
H1524	LK-500B	H1525	LK-500BS	LMDV-3530	
H1526	LK-600B	H1527	LK-600BS	LMDV-4035	

(ref. Form # 750,166M)

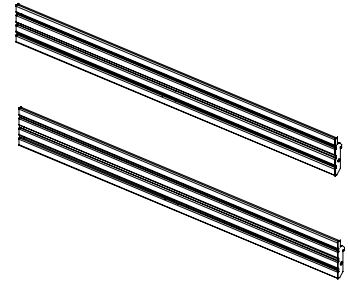

* Lennox Nameplate Logo, 12L15, is sold separately.

Polished Brass & Brushed Stainless Louvers Kits

These kits include a top 4-louver assembly and a bottom 4-louver assembly. They provide a touch of elegance. These kits can be retrofitted to previously installed appliances.

2- Piece Door Frame Kits					
Polished Brass		Brushed Stainless		Models Where Used	
Cat. #	Model	Cat. #	Model		
98L18	2DFK33PB	98L19	2DFK33BS	LMDVT-3328 LMDVR-3328	
26M88	2DFK35PB	26M91	2DFK35BS	LMDV-4035	
26M89	2DFK40PB	26M92	2DFK40BS	LMDV-4035	

(ref. Form # 750,098M)

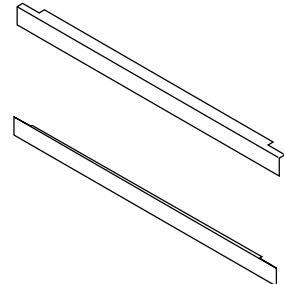

Polished Brass & Brushed Stainless 2-Piece Door Frame Kits

These kits are designed to attach directly to the front face of the appliance at the glass enclosure panel's top and bottom edges.

4 Piece Door Trim Kits					
Polished Brass		Brushed Stainless		Models Where Used	
Cat. #	Model	Cat. #	Model		
98L22	4DFK33PB	98L23	4DFK33BS	LMDVT-3328 LMDVR-3328	
26M82	4DFK35PB	26M85	4DFK35BS	LMDV-3530	
26M83	4DFK40PB	26M86	4DFK40BS	LMDV-4035	

(ref. Form # 750,098M)

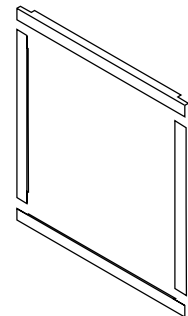

Door Frame Kits

A decorative door frame kit is available for use with these appliances. It is designed to attach directly to the front face of the appliance at the four edges of the glass enclosure panel resulting in the appearance of a picture frame.

Eyebrow Hood Kits					
Polished Brass		Brushed Stainless		Models Where Used	
Cat. #	Model	Cat. #	Model		
98L10	EB33PB	98L11	EB33BS	LMDVT-3328 LMDVR-3328	
96K67	EB35PB	88L49	EB35BS	LMDV-4035	
96K68	EB40PB	88L50	EB40BS	LMDV-4035	
* These hood kits replace the standard hood that comes with these fireplaces.					

(ref. Form #504,142M)

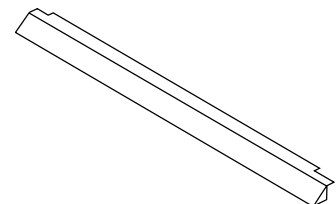

Polished Brass & Brushed Stainless Hood Kits

Attractive hoods are available in two styles. These hoods are designed to be fitted to the glass viewing sides of the appliance. In addition to providing an aesthetically pleasing appearance to your appliance installation, the hood reduces heat effects to decorative mantles and finish materials located above the fireplace opening. The hood kit replaces the standard hood that comes with these appliances and snaps into place. These kits can be retrofitted to previously installed appliances.

ACCESSORY COMPONENTS

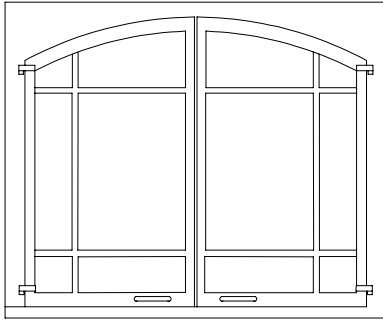

Tall Style View Doors -

These decorative screen doors are offered in four attractive finishes and fit on the face of the appliance over the glass doorframe to prevent direct contact with the hot glass surface. The screens prevent direct contact with the hot glass surface. These doors replace the bottom louver assembly and cover the control compartment which elongates the appearance of the height of the fireplace face.

Style View Tall Arch Pane Screen Door Kits		
Cat#	Model	Description
H3525	TAPD35C	35", Charcoal
H3527	TAPD35SP	35", Satin Pewter
H3529	TAPD40C	40", Charcoal
H3531	TAPD40SP	40", Satin Pewter

Note: Door & Trim Kits are for 1 side only. If set is desired, order 2 kits.

Sunrise Style (upper grille shown)



Crescent Style (lower grille shown)

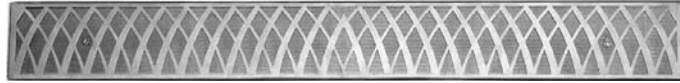

Cat. No.#	Model	Description	Model Series
H3565	SUGK35C	35" Charcoal	UPPER GRILLE KITS SUNRISE
H3567	SUGK35SP	35" Satin Pewter	
H3573	SUGK40C	40" Charcoal	
H3575	SUGK40SP	40" Satin Pewter	

H3541	CUGK35C	35" Charcoal	UPPER GRILLE KITS CRESCENTS
H3543	CUGK35SP	35" Satin Pewter	
H3549	CUGK40C	40" Charcoal	
H3551	CUGK40SP	40" Satin Pewter	

H3569	SLGK35C	35" Charcoal	LOWER GRILLE KITS SUNRISE
H3571	SLGK35SP	35" Satin Pewter	
H3577	SLGK40C	40" Charcoal	
H3579	SLGK40SP	40" Satin Pewter	

H3545	CLGK35C	35" Charcoal	LOWER GRILLE KITS CRESCENTS
H3547	CLGK35SP	35" Satin Pewter	
H3553	CLGK40C	40" Charcoal	
H3555	CLGK40SP	40" Satin Pewter	

(ref. Form # 750,202M)

Decorative Grille Kits

These decorative grilles are offered in two attractive finishes and fit on the face of the appliance in place of the standard louvers.

REPLACEMENT PARTS LIST

Item #	Description	LMDVT-3328 & LMDVR-3328		LMDV-3530		LMDV-4035	
		Part No.	Qty.	Part No.	Qty.	Part No.	Qty.
1	Hood	H4574	1	97K51	1	97K52	1
2	Louver Assembly, Top, Charcoal	H3375	1	H3376	1	H3377	1
3	*Louver Assembly, Bottom, Charcoal	H3378	1	H3379	1	H3380	1
4	Enclosure, Glass Front (Complete)	H4575	1	H4864	1	H3724	1
5	Nameplate, Lennox	12L15	1	12L15	1	12L15	1
6	Latch	69L21	2	69L21	2	69L21	2
7	Log Set (Complete)	H3366	1	H3366	1	H3365	1
8	Burner Assembly	24M58	1	24M58	1	24M59	1
9	Orifice, Main Burner - Natural Gas	39L66	1	60J80	1	24M10	1
9	Orifice, Main Burner - Propane Gas	99K78	1	12L52	1	21L01	1
10	Bag of Glowing Embers (Rockwool)	88L53	1	88L53	1	88L53	1
10	Bag of Decorative Volcanic Stone	80L42	1	80L42	1	80L42	1
10	Bag of Vermiculite	H3696	1	H3696	1	H3696	1
11	Gas Line Flexible Connector	93L32	1	93L32	1	93L32	1

* Lennox Nameplate Logo, 12L15, is sold separately.

Gas Controls - SIT Millivolt					
		Natural Gas		Propane Gas	
		Part No.	Qty.	Part No.	Qty.
12	Gas Valve, SIT	H1657	1	88J53	1
13	Piezo Igniter	10K86	1	10K86	1
14	Pilot Assembly	69L17	1	69L18	1
15	Pilot Generator	60J79	1	60J79	1
16	Thermocouple	74L57	1	74L57	1
17	Pilot Tube	74L56	1	74L56	1
18	Electrode and Cable	74L58	1	74L58	1
19	Pilot Shield	H3737	1	H3737	1

Gas Controls - Honeywell Millivolt					
		Natural Gas		Propane Gas	
		Part No.	Qty.	Part No.	Qty.
20	Gas Valve, Honeywell	24M12	1	82L87	1
21	Piezo Igniter	24M89	1	24M89	1
22	Pilot Assembly	67L70	1	67L70	1
23	Pilot Generator	60J79	1	60J79	1
24	Thermocouple	67L67	1	67L67	1
25	Pilot Tube	67L68	1	67L68	1
26	Electrode and Cable	67L87	1	67L87	1
27	Pilot Shield	H3737	1	H3737	1

Gas Controls - Honeywell Electronic					
		Natural Gas		Propane Gas	
		Part No.	Qty.	Part No.	Qty.
28	Gas Valve, Honeywell	62L18	1	62L19	1
29	Pilot Assembly	62L14	1	62L15	1
30	Transformer	42J32	1	42J32	1
31	Igniter Assembly (Kit)	87L54	1	87L54	1
32	Pilot Shield	H1596	1	H1596	1

REPLACEMENT PARTS

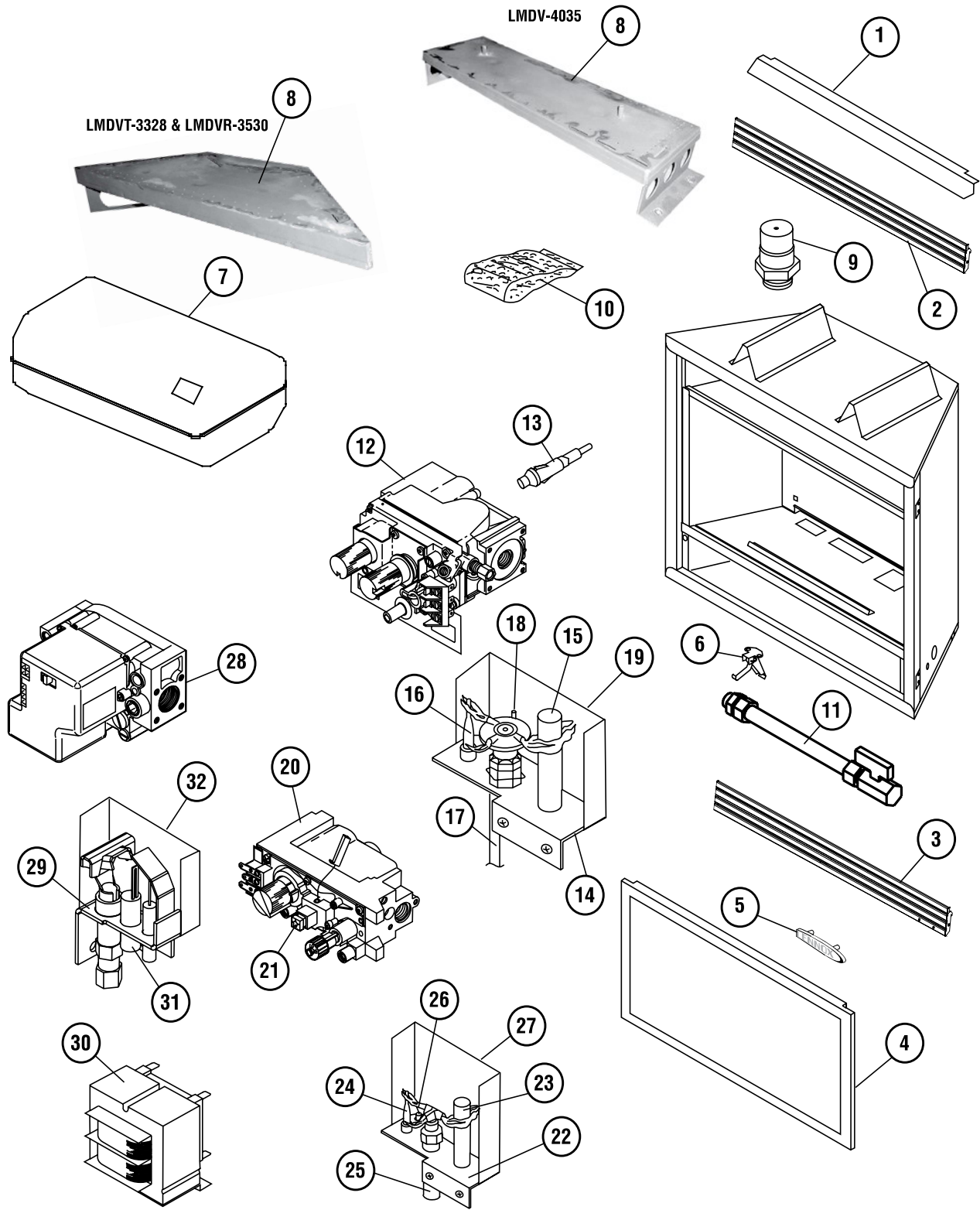

NOTE: DIAGRAMS & ILLUSTRATIONS ARE NOT TO SCALE.



We recommend that our gas hearth products be installed and serviced by professionals who are certified in the U.S. by the National Fireplace Institute® (NFI) as NFI Gas Specialists.