

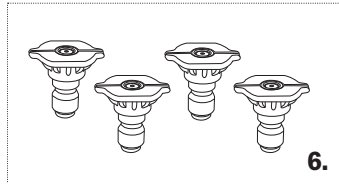

PRESSURE WASHER BREAKDOWN

PE-2565HWAARSP



REF #	DESCRIPTION	PART #
1	Frame	85.600.116
2	Engine - Honda GX200	85.510.067
3	Pump - AR RCV3G25D	85.129.005B
4	Wheel	85.660.004BF
5	Soap Hose	85.400.005
6	Nozzle Set	85.210.035
7	Gun & Wand	85.205.055
8	Hose 50' x 3/8"	85.238.153

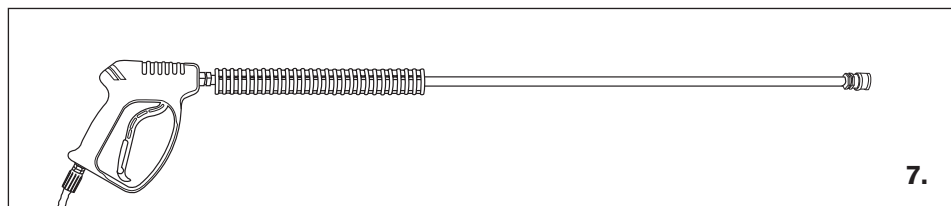
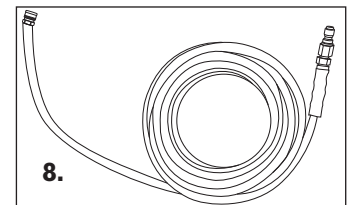
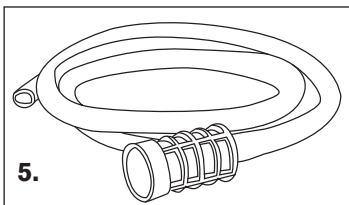



PRESSURE WASHER BREAKDOWN

PE-2565HWAARSP

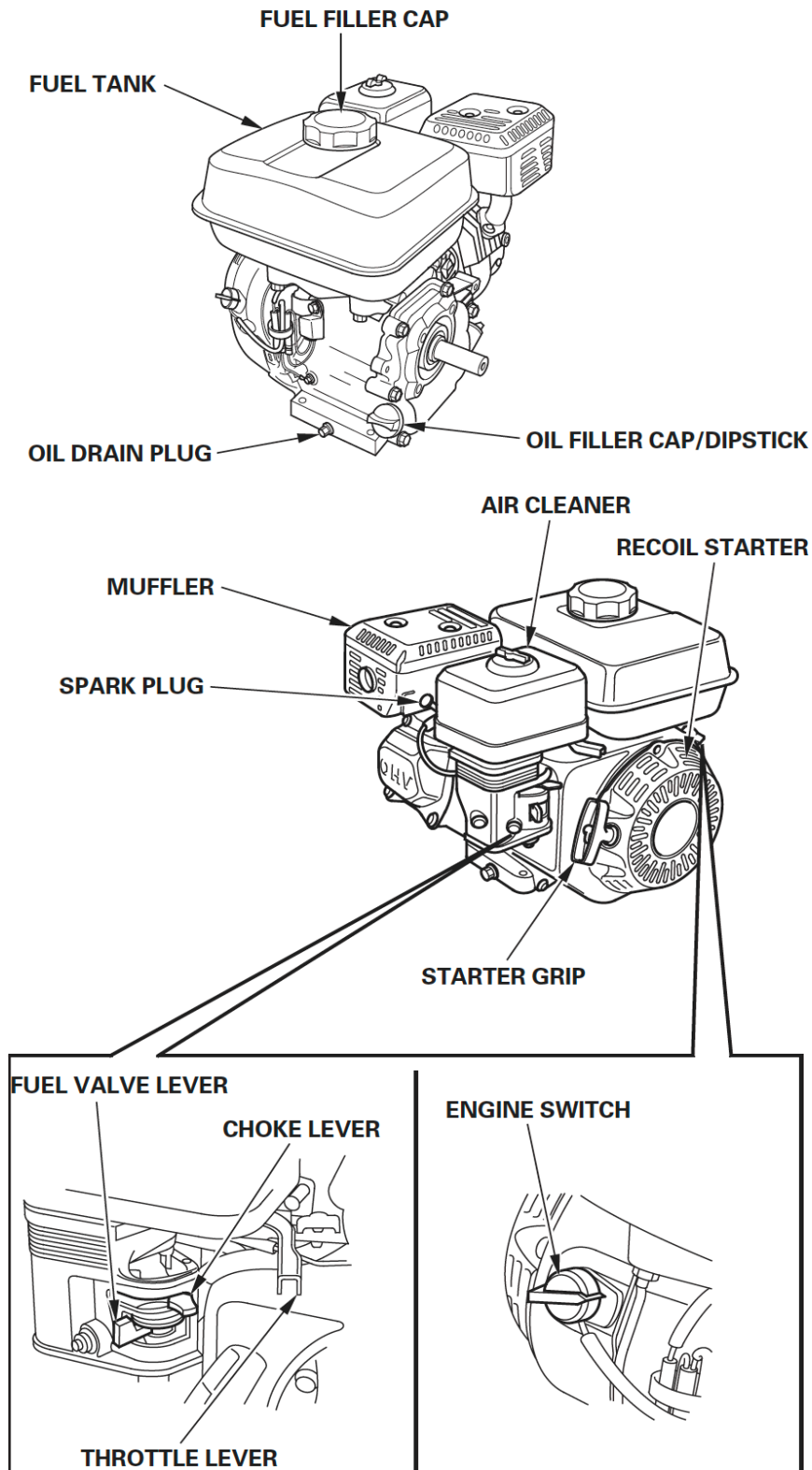



PRESSURE WASHER BREAKDOWN

PE-2565HWAARSP

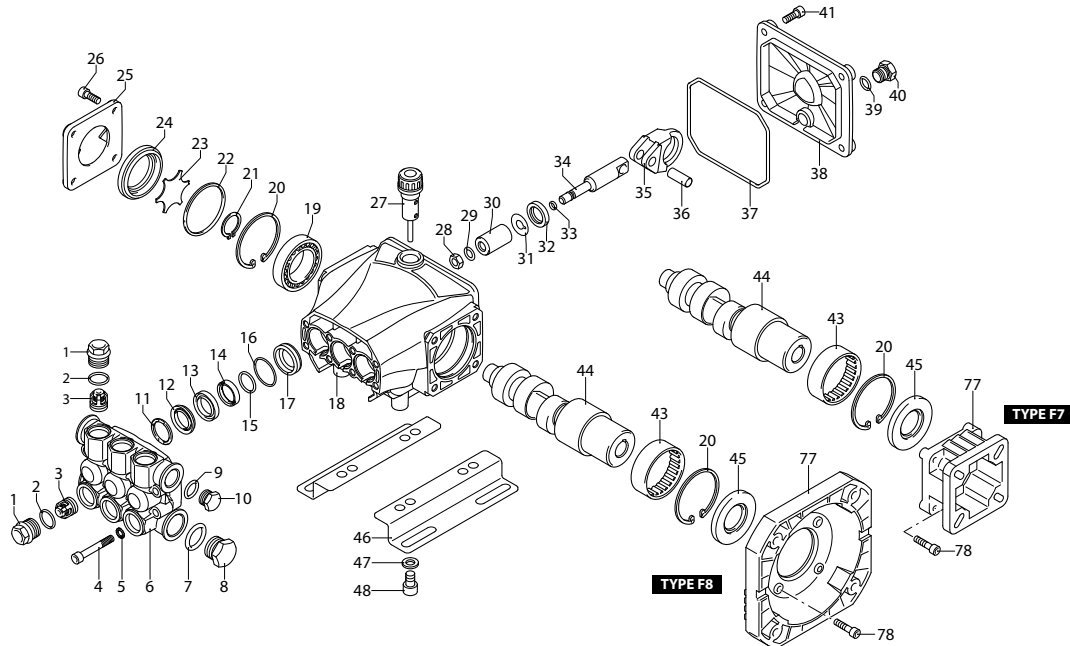

Repair Kits

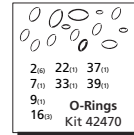

Pos	Code	Description	Qty.	Pos	Code	Description	Qty.	Legend		
1	3200110	Plug	(216 in/lbs) 6	37	2760280	O-Ring	1	For ○	For ●	For ◆
2	120690	O-Ring	6	38	3200030	Rear cover	1	For RCV2G25E	For RCV3G25E	For RCV2G25D
3	2769050	Complete valve	(92 in/lbs) 6	39	820510	O-Ring	1			
4	800410	Screw	8	40	880581	Plug	1	For ■	For ⌘	For ★
5	1381550	Washer	8	41	3200220	Screw	4	For RCV25G27D	For RCV3G25D	For RCV35G25
6	3200020	Head	1	44	3201200	Crankshaft - Solid Shaft	○1			
7	180101	O-Ring	1	44	3200860	Crankshaft - Solid Shaft	◆1			
8	820361	Plug	(354 in/lbs) 1	44	3201180	Crankshaft - Solid Shaft	◆1			
9	740290	O-Ring	1	44	3201170	Crankshaft - Hollow Shaft	■1			
10	1980740	Plug	(221 in/lbs) 1	44	3200350	Crankshaft - Hollow Shaft	⌘1			
11	1780140	Ring	3	44	3200340	Crankshaft - Hollow Shaft	★1			
12	1780720	Gasket	3	42	3200330	Key	1			
13	3200130	Piston guide	3	43	2760350	Bearing	1			
14	3200142	Gasket	3	45	480671	Seal	1			
15	3200260	Ring	3	46	320210	Base	2			
16	770260	O-Ring	3	47	1322640	Washer	4			
17	3200120	Piston guide	3	48	850250	Screw	4			
18	3200010	Pump body	1	77	1320060	Flange (F7)	1			
19	1780490	Bearing	1	78	1200430	Screw	4			
20	1260790	Snap ring	2		AR64516	Oil	2			
21	1780550	Snap ring	1			<i>OIL CAPACITY - 9.81 OZ</i>				
22	395081	O-Ring	1							
23	3200090	Disc	1							
24	3200080	Oil indicator	1							
25	3200070	Cover	1							
26	1200430	Screw	(92 in/lbs) 8							
27	880130	Oil cap	1							
28	1260110	Nut	(106 in/lbs) 3							
29	1260100	Washer	3							
30	1260210	Piston guide	3							
31	1260091	Spacer	3							
32	1260460	Seal	3							
33	480480	O-Ring	3							
34	3200060	Piston guide	3							
35	3200040	Conrod	3							
36	1780050	Conrod pin	3							