



WATER PUMP BREAKDOWN

WP-2065HL



REF #	DESCRIPTION	QTY	PARTS
N/A	Honda GX200 Engine	1	See Honda Website



WATER PUMP BREAKDOWN

WP-2065HL

WATER PUMP ASSEMBLY

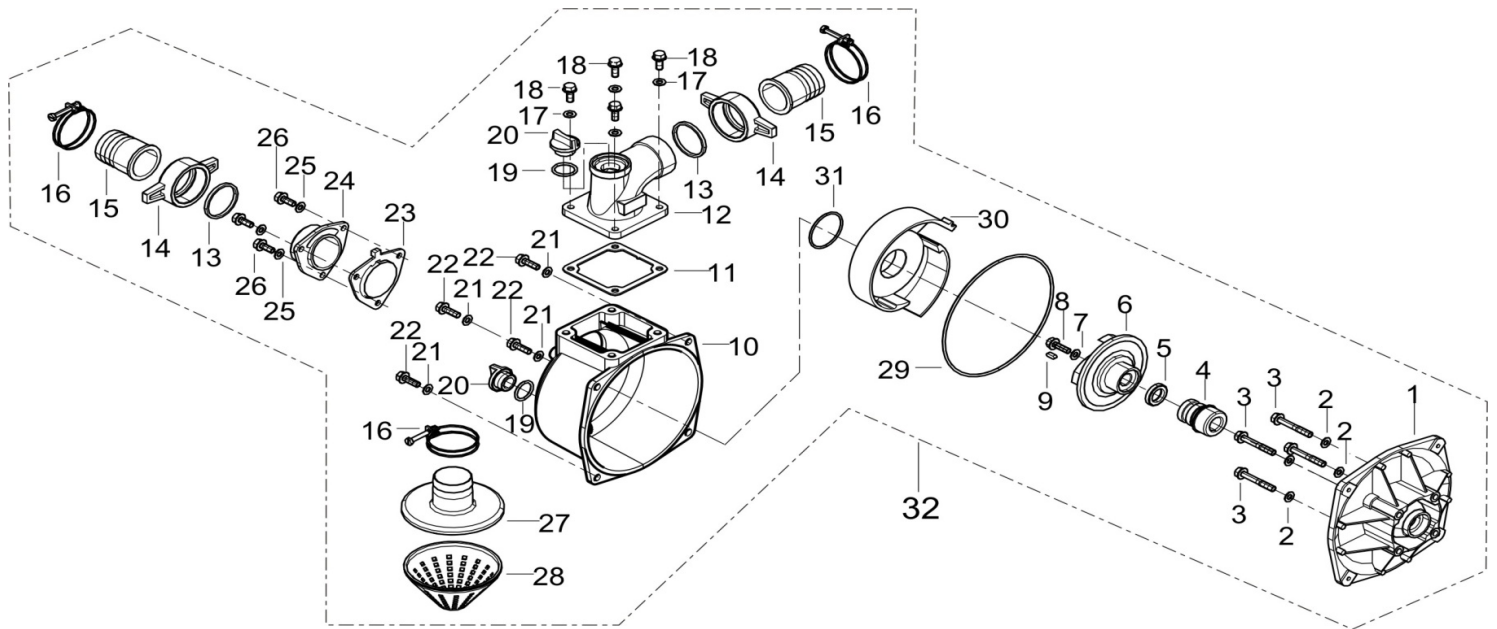

REF #	DESCRIPTION	QTY	BE PART #
1	Water Pump Joint	1	85.571.136
2	Washer	4	50.002.200
3	Bolt	4	
7	Washer	1	
8	Bolt	1	
9	Key	1	
22	Bolt	4	
25	Washer	4	
4	Mechanism Seal Assembly	1	50.002.202
5	Porcelain Seal	1	
11	Outlet Gasket	1	
23	Inltet Water Gasket	1	
29	Water Pump Joint Cushion	1	
31	Whorl Case Sealing Ring	1	50.002.201
6	Water Pump Impeller	1	
10	Pump Body	1	85.571.134
19	Screw Plug Washer	2	50.002.203
20	Thread Plug	2	
12	Water Outlet	1	50.002.204
24	Water Inlet	1	
30	Whorl Case	1	85.571.135



WATER PUMP BREAKDOWN

WP-2065HL

FRAME ASSEMBLY

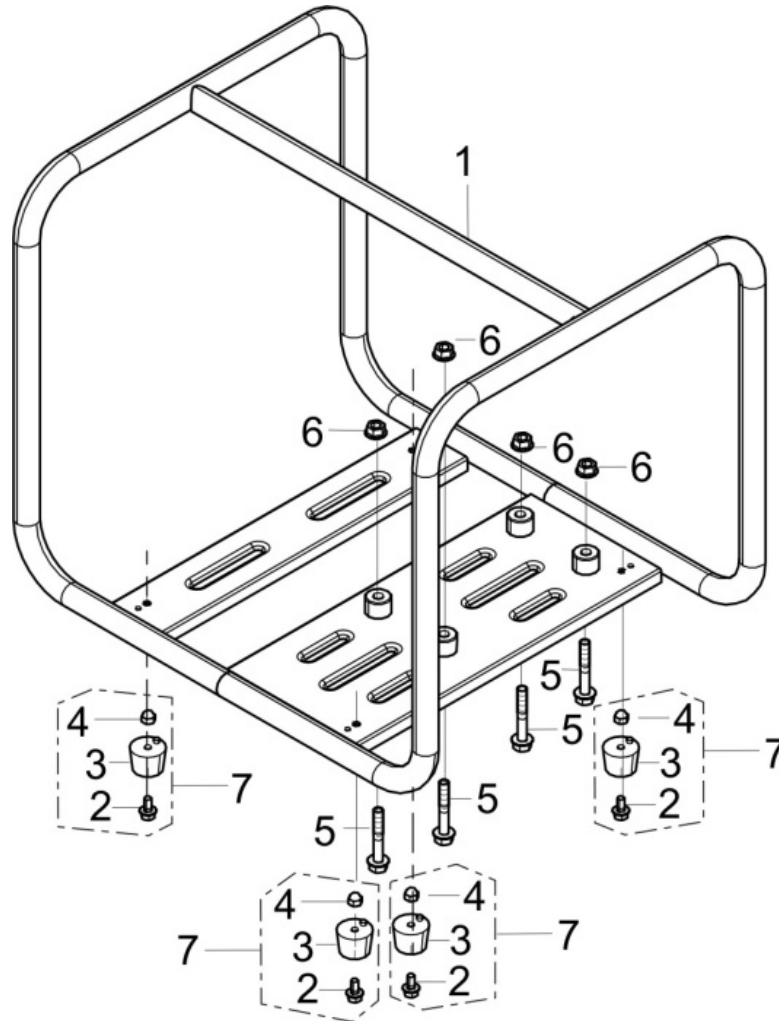

REF #	DESCRIPTION	QTY	BE PART #
2	Bolt	4	50.002.205
3	Engine Frame Shock Absorption Seat	4	
4	Acorn Nut	4	