



INSTALLATION INSTRUCTIONS

STANDARD SERIES

Unvented Decorative Gas Fireplaces
P/N 904538 REV. E 02/2004

MODELS

CF5500-CMN
CF5500-CMP

CF6500-CMN
CF6500-CMP

RETAIN THESE INSTRUCTIONS FOR FUTURE REFERENCE



We suggest that our gas hearth products be installed and serviced by professionals who are certified in the U.S. by the National Fireplace Institute® (NFI) as NFI Gas Specialists.



FOR USE ONLY WITH DECORATIVE TYPE UNVENTED ROOM HEATERS.

DO NOT BUILD A WOOD FIRE.

WARNING: IMPROPER INSTALLATION, ADJUSTMENT, ALTERATION, SERVICE OR MAINTENANCE CAN CAUSE INJURY OR PROPERTY DAMAGE. REFER TO THIS MANUAL. FOR ASSISTANCE OR ADDITIONAL INFORMATION CONSULT A QUALIFIED INSTALLER, SERVICE AGENCY OR THE GAS SUPPLIER.

WARNING: DO NOT BURN WOOD OR OTHER MATERIAL IN THESE APPLIANCES.

CAREFULLY REVIEW THE INSTRUCTIONS SUPPLIED WITH THE DECORATIVE TYPE UNVENTED ROOM HEATER FOR THE MINIMUM FIREPLACE SIZE REQUIREMENT.

DO NOT INSTALL THE APPLIANCE IN THIS FIREBOX, UNLESS THIS FIREBOX MEETS THE MINIMUM DIMENSIONS REQUIRED FOR THE INSTALLATIONS.

This is an unvented gas-fired heater. It uses air (oxygen) from the room in which it is installed. Provisions for adequate combustion and ventilation air must be provided. Refer to Combustion and Ventilation Air Section, Page 3.

Due to high temperatures, the appliance should be located out of traffic and away from furniture or draperies.

Do not place clothing or other materials on or near this appliance.

IMPORTANT: READ AND UNDERSTAND THESE INSTRUCTIONS COMPLETELY BEFORE INSTALLING YOUR UNVENTED ROOM HEATERS.

WARNING: IF THE INFORMATION IN THIS MANUAL IS NOT FOLLOWED EXACTLY, A FIRE OR EXPLOSION MAY RESULT CAUSING PROPERTY DAMAGE, PERSONAL INJURY OR LOSS OF LIFE.

FOR YOUR SAFETY: Do not store or use gasoline or other flammable vapors or liquids in the vicinity of this or any other appliance.

FOR YOUR SAFETY: What to do if you smell gas:

- DO NOT light any appliance.
- DO NOT touch any electrical switches.
- DO NOT use any phone in your building.
- Immediately call your gas supplier from a neighbor's phone.

Follow your gas suppliers instructions.

- If your gas supplier cannot be reached, call the fire department.

Installation and service must be performed by a qualified installer, service agency or the gas supplier.

ACCESSORIES AND COMPONENTS

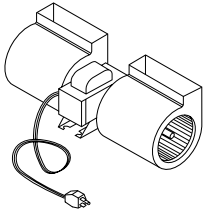

Forced Air Kit **FAB-1100**

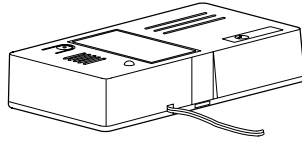

CO Sensor Kit **CMSK**

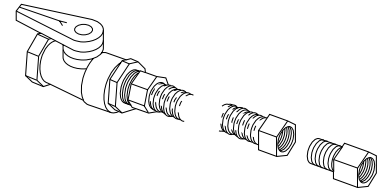

Gas Flex Line Kit **GFLV**

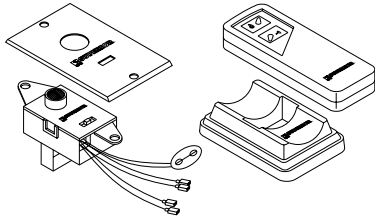

Remote Control Kit **RCK**

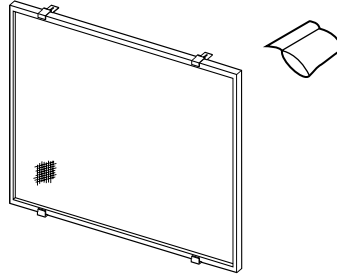

Screen Panel Kits **SPK-5000**
SPK-6000

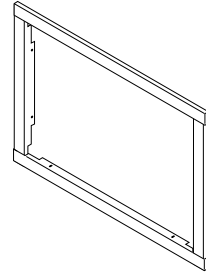

Brass Square Surround Kits **BSK-5**
BSK-6

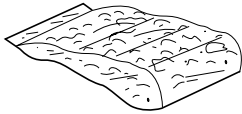

Decorative Volcanic Stone **DVS**

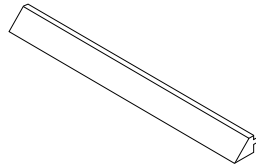

Brass Hood Kit **VF5-PBH**
VF6-PBH

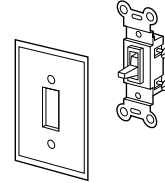

Wall Switch Kit **WSK**

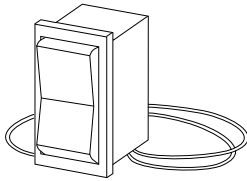

Rocker Switch Kit **RS**

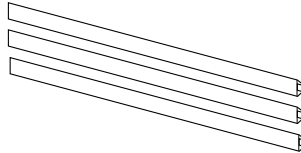

Brass Louver Kits **VF5-BRLK**
VF6-BRLK

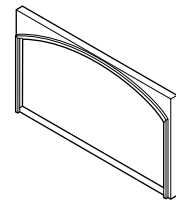

1-Piece Decorative Arch Frame Kit **DAT-5000-1**
DAT-6000-1

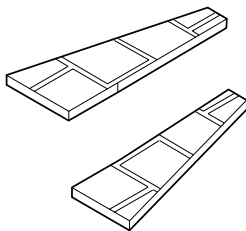

Bottom Brick Liner (CF-5500) **BBL-5**

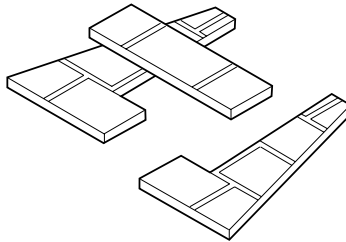

Bottom Brick Liner (CF-6500) **BBL-6**

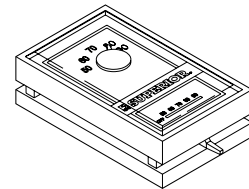

Thermostat **WTK**

NOTE: DIAGRAMS & ILLUSTRATION NOT TO SCALE.

REPLACEMENT PARTS LIST — MILLIVOLT

No.	DESCRIPTION	CF5500-CMN		CF5500-CMP		CF6500-CMN		CF6500-CMP	
		Part No.	Qty.	Part No.	Qty.	Part No.	Qty.	Part No.	Qty.
1.	Gas Fireplace Assembly	128231	1	128232	1	128551	1	128552	1
2.	Bar, Louver (Black)	024504	4	024504	4	104951	4	104951	4
3.	Hood (Black), Clean Face	108951	1	108951	1	108971	1	108971	1
4.	Screw	000861	3	000861	3	000861	3	000861	3
5.	Replacement Glass Panel with Gasket	064099	1	064099	1	064101	1	064101	1
6.	Door Switch	094468	1	094468	1	094468	1	094468	1
7.	Pan Burner Assembly	128281	1	128281	1	128661	1	128661	1
8.	Log Grate	126461	1	126461	1	128831	1	128831	1
9.	Log Set (Split, Complete)	904555	1	904555	1	904556	1	904556	1
a.	Log, Rear Right	903923	1	903923	1	904563	1	904563	1
b.	Log, Rear	903921	1	903921	1	904561	1	904561	1
c.	Log, Front	903922	1	903922	1	904562	1	904562	1
d.	Log, Front Right	903924	1	903924	1	904564	1	904564	1
10.	Venturi Tube	097506	1	097506	1	097506	1	097506	1
11.	Gasket	900272	1	900272	1	900272	1	900272	1
12.	Bag of Rockwool/Ember Coals	125013	1	125013	1	125013	1	125013	1
13.	Refractory Liner, Rear	903502	1	903502	1	903499	1	903499	1
	Refractory Liner, Side Panel	903500	2	903500	2	903497	2	903497	2

GAS CONTROLS — MILLIVOLT

No.	DESCRIPTION	CF5500-CMN CF6500-CMN		CF5500-CMP CF6500-CMP	
		Part No.	Qty.	Part No.	Qty.
20.	Gas Valve - SIT	901916	1	901917	1
	Gas Valve - Honeywell	67L0101	1	67L0201	1
21.	Piezo Igniter	111061	1	111061	1
22.	Orifice/CF5500	903461	1	901694	1
	Orifice/CF6500	903883	1	901699	1
23.	Pilot Assembly (ODS)	901914	1	901915	1
24.	Regulator	903218	1	112081	1

REPLACEMENT PARTS

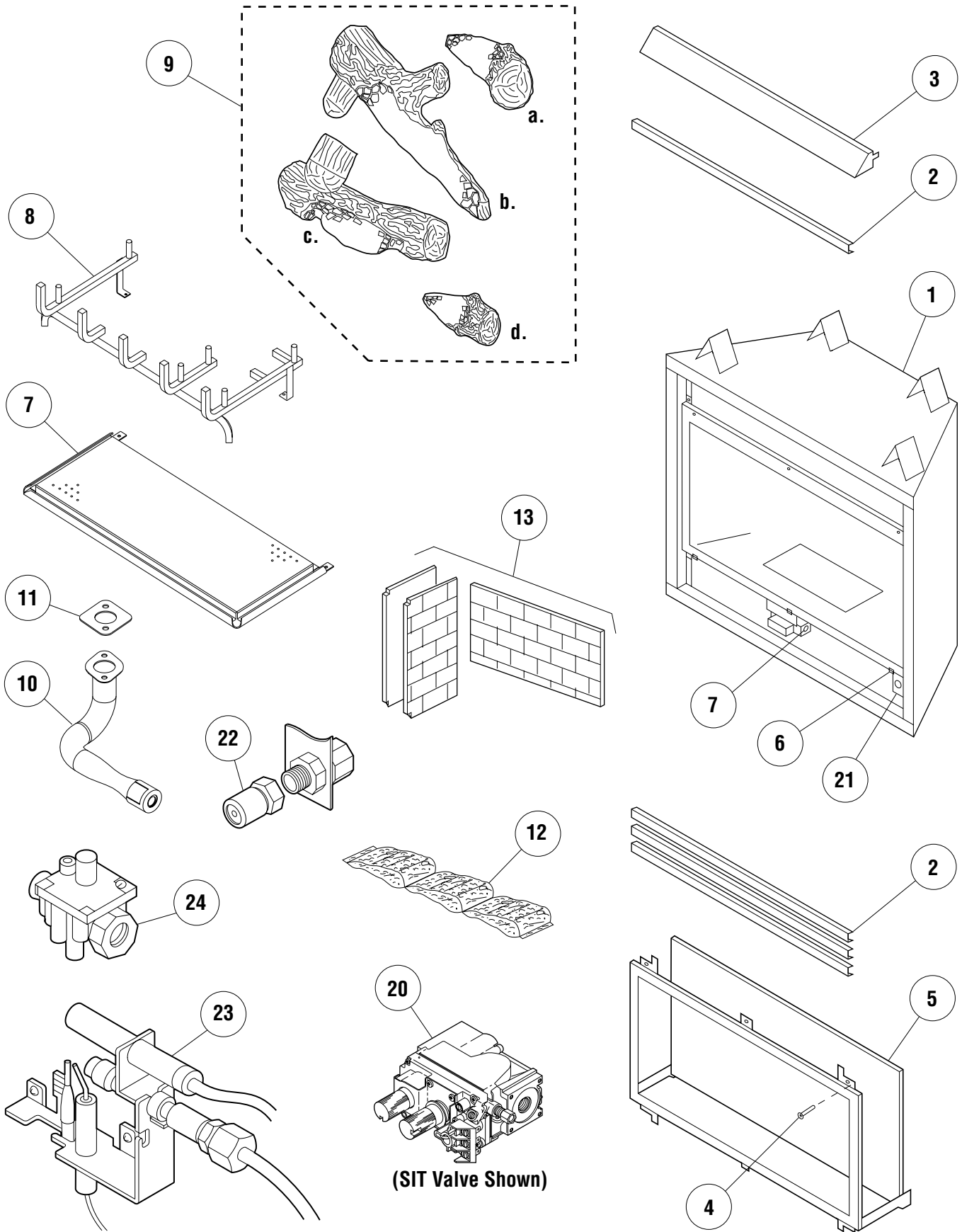

(SIT Valve Shown)

NOTE: DIAGRAMS & ILLUSTRATION NOT TO SCALE.