



Intertek Report No.
100513650PRT-001

P/N 506010-10 Rev. NC 12/2013

This manual is part of a set of two supporting this product.

Refer to P/N 506009-14 for Installation Instructions.

Ce manuel est disponible en français, simplement en faire la demande. Numéro de la pièce 506010-11.

WHAT'S INSIDE

Table of Contents	2
Safety and Your Fireplace	2
FREE Safety Guard Offer (Protects Against Burns)	2
Important Safety Information	4
Attaching the Safety-in-Operation Warnings	5
[EN FRANÇAIS] L'information de sûreté importante	3-4
Apposition des mises en garde relatives à la sécurité d'utilisation	5
[EN ESPAÑOL] Información importante de seguridad	3-4
Colocación de advertencias de seguridad en operación	5

CARE AND OPERATION INSTRUCTIONS

Signature Series 40 and 45 in.
Direct Vent Gas Fireplaces

MODELS		
DRT6340TEN		DRT6345TEN
DRT6340TEP		DRT6345TEP
DRC6340TEN		DRC6345TEN
DRC6340TEP		DRC6345TEP

Decorative Product: Not for use as a heating appliance.

NOTICE: Fireplace is not to be operated by a thermostat.



INSTALLER: Leave this manual with the appliance.
CONSUMER: Retain this manual for future reference.
INSTALLATEUR : Laissez cette notice avec l'appareil.
CONSOMMATEUR : Conservez cette notice pour consultation ultérieure.



! WARNING / AVERTISSEMENT / AVISO

<p>HOT GLASS WILL CAUSE BURNS. DO NOT TOUCH GLASS UNTIL COOLED NEVER ALLOW CHILDREN TO TOUCH GLASS.</p>		<p>UNE SURFACE VITRÉE CHAUDE PEUT CAUSER DES BRÛLURES. LAISSER REFROIDIR LA SURFACE VITRÉE AVANT D'Y TOUCHER. NE PERMETTEZ JAMAIS À UN ENFANT DE TOUCHER LA SURFACE VITRÉE.</p>	<p>EL VIDRIO CALIENTE CAUSARÁ QUEMADURAS. USTED DEBE NUNCA TOCAR EL VIDRIO CALIENTE. LOS NIÑOS DEBEN NUNCA TOCAR EL VIDRIO.</p>
--	---	--	--

WARNING: If the information in these instructions is not followed exactly, a fire or explosion may result, causing property damage, personal injury, or death.

- Do not store or use gasoline or other flammable vapors and liquids in the vicinity of this or any other appliance.
- **WHAT TO DO IF YOU SMELL GAS:**
 - Do not try to light any appliance.
 - Do not touch any electrical switch; do not use any phone in your building.
 - Immediately call your gas supplier from a neighbor's phone. Follow the gas supplier's instructions.
 - If you cannot reach your gas supplier, call the fire department.
- Installation and service must be performed by a qualified installer, service agency or the gas supplier.

AVERTISSEMENT : Assurez-vous de bien suivre les instructions données dans cette notice pour réduire au minimum le risque d'incendie ou d'explosion ou pour éviter tout dommage matériel, toute blessure ou la mort.

- Ne pas entreposer ni utiliser d'essence ni d'autres vapeurs ou liquides inflammables dans le voisinage de cet appareil ou de tout autre appareil.
- **QUE FAIRE SI VOUS SENTEZ UNE ODEUR DE GAZ :**
 - Ne pas tenter d'allumer d'appareil.
 - Ne touchez à aucun interrupteur. Ne pas vous servir des téléphones se trouvant dans le bâtiment où vous trouvez.
 - Appelez immédiatement votre fournisseur de gaz depuis un voisin. Suivez les instructions du fournisseur.
 - Si vous ne pouvez rejoindre le fournisseur de gaz, appelez le service des incendies.
- L'installation et l'entretien doivent être assurés par un installateur ou un service d'entretien qualifié ou par le fournisseur de gaz.

ACCESSORY COMPONENTS

Bag of Glowing Embers
Bag of Volcanic Stone
Bag of Platinum Embers



Replacement ember material, volcanic stone and vermiculite are available for use with these appliances. Order them to replace materials as part of the periodic maintenance of the appliance.

Firebox Accessories/Parts		
Cat. No.	Model	Description
88L53	FGE	Bag of Glowing Embers
80L42	FDVS	Bag of Volcanic Stone
H8312	PGE	Bag of Platinum Embers

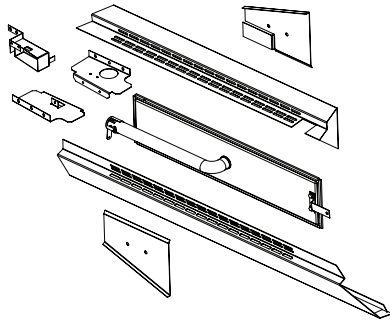

Floor Options

Optional contemporary burner/floor kits include the burner and porcelain floors and requires purchase of a porcelain panel kit and one glass media kit.

Contemporary Burner/Floor Kits		
Cat. No.	Model	Description
H8694	CBFK-MDLX40	Contemporary Burner/Floor Kit, 40 in.
H8695	CBFK-MDLX45	Contemporary Burner/Floor Kit, 45 in.

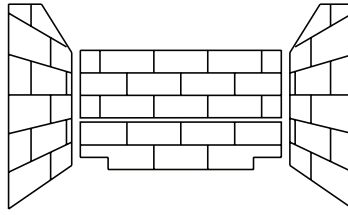

Firebox Liner Kits

Choose from ceramic brick or porcelain panels.

Ceramic and Porcelain Firebox Liner Kits		
Fireplace	Cat. No. / Model	Description
40 in.	H8697 LKC-BFRS-MDLX40	Ceramic, Buff Rustic
	H2220 BLKH-LSM40	Ceramic, Buff Herringbone
	H8581 LKP-BK-MDLX40	Porcelain, Black
45 in.	H8699 LKC-BFRS-MDLX45	Ceramic, Buff Rustic
	H2224 BLKH-LSM45	Ceramic, Buff Herringbone
	H8696 LKP-BK-MDLX45	Porcelain, Black



Touch-Up Paint Kit

Repair of minor scratches and discoloration of the appliances black painted surfaces may be accomplished with the touch-up paint kit.

Touch-Up Paint Kit		
Cat. No.	Model	Description
90L73	FTPK-B	Black Paint Kit

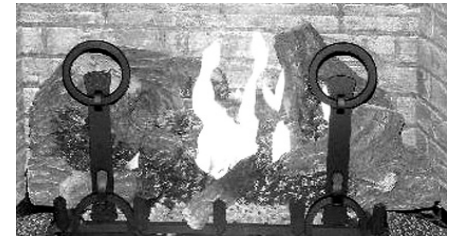

Log Sets

This finely crafted log set has detailing that replicates the natural look of real wood.

Aged Oak Log Set	
Cat. No.	Description
F1719	Aged Oak Log Set

Glass Media Kits

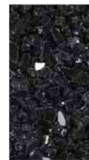

Reflective Black

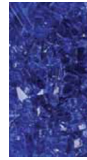

Reflective Blue



Platinum



Goldfinger



Copper

Cat. No.	Model	Description
H8412	CRSHGL-RBLK	Reflective Black
H8424	CRSHGL-RBLU	Reflective Blue
H8413	CRSHGL-P	Platinum
H8538	CRSHGL-GF	Goldfinger
H8539	CRSHGL-C	Copper

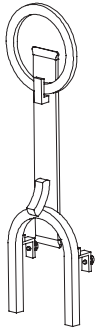

Mission

Andiron Grate Kits

The andiron kits attach to the grate assembly.

Andiron Grate Kits	
Fits Fireplace Models	Cat. No. (Model)
LSM40-2 & LSM45-2	H2227 (AKM-LSM)

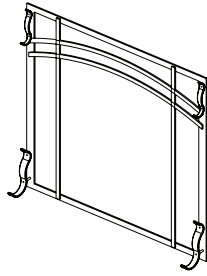

Dual Arch Screen Kits

These Dual Arch screen kits can be placed in front of the glass enclosure panel to help prevent direct human contact with the hot glass surface.

Dual Arch Screen Kits		
Cat. No.	Model	Description
H5051	DASK-LSM40-2	Dual Arch Screen
H5054	DASK-LSM45-2	Dual Arch Screen

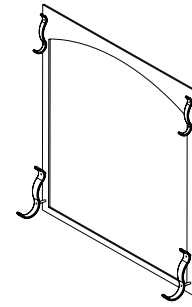

Arch Screen Kits

These Arch Screen kits can be placed in front of the glass enclosure panel to help prevent direct human contact with the hot glass surface.

Arch Screen Kits		
Cat. No.	Model	Description
H5053	ASK-LSM40-2	Arch Screen Kit
H5056	ASK-LSM45-2	Arch Screen Kit

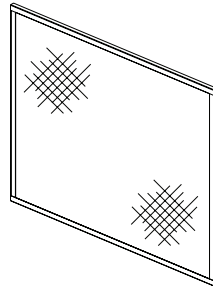

Barrier Screen Kits

These Barrier Screen Panel kits can be placed in front of the glass enclosure panel to help prevent direct human contact with the hot glass surface.

Barrier Screen Kits		
Cat. No.	Model	Description
LSM40-2		
H4805	BSK40	Barrier Screen
LSM45-2		
H4806	BSK45	Barrier Screen

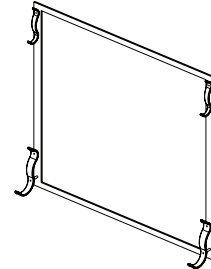

Classic Screen Kits

These Classic Screen kits can be placed in front of the glass enclosure panel to help prevent direct human contact with the hot glass surface.

Classic Screen Kits		
Cat. No.	Model	Description
H5052	SK-LSM40-2	Classic Screen Kit
H5055	SK-LSM45-2	Classic Screen Kit

REPLACEMENT PARTS LIST

Item No.	Description	40 in.		45 in.	
		Cat. No.	Qty.	Cat. No.	Qty.
1	Door Modesty Shield	H4808	1	H4809	1
2	Log Set (Aged Oak) (Traditional only)	F1719	1	F1719	1
3	Enclosure, Glass Door	H2281	1	H2282	1
4	Spring Latch Assembly	H2274	2	H2274	2
5	Burner Assembly, Traditional	H4817	1	H4817	1
5	Burner Assembly, Contemporary	F1880	1	F1880	1
6	Venturi (Traditional only)	H1428	1	H1428	1
7	Gasket—Venturi (Traditional only)	43K85	1	43K85	1
8	Access Plate	H2277	1	H2277	1
9	Screen Rod	H2278	1	H2279	1
10	Screen	H1427	2	H1169	2
11	Gasket, Access Plate	H1452	1	H1452	1
12	Gas Line Tubing	H2283	1	H2284	1
13	Connector, Male	H2285	1	H2285	1
14	Orifice, Natural Gas	H2286	1	H8808	1
14	Orifice, Propane Gas	H2287	1	H4816	1
15	Bag of Glowing Embers	88L53	1	88L53	1
16	Grate Assembly (Traditional only)	H4907	1	H4907	1
17	Gas Line, Flexible Connection	93L32	1	93L32	1
18	Modesty Panel, Right Side	H3371	1	H3372	1
19	Modesty Panel, Left Side	H3373	1	H3374	1
20	Floor Panel	H3369	1	H3370	1
21	Bag of Volcanic Stone (Traditional only)	80L42	1	80L42	2
22	Bag of Platinum Embers (Traditional only)	H8312	1	H8312	1

Contact an Innovative Hearth Products dealer to obtain any of these parts. Never use substitute materials. Use of non-approved parts can result in poor performance and safety hazards.

Gas Controls—SIT Electronic

Item No.	Description	Natural Gas		Propane Gas	
		Part No.	Qty.	Part No.	Qty.
23	Gas Valve, SIT	H7270	1	H7271	1
24	Pilot Assembly	H7268	1	H7269	1
25	Control Module	H8656	1	H8656	1
26	Wiring Harness, Power	H8811	1	H8811	1
27	Wiring Harness, Control	H8814	1	H8814	1
28	Wiring Harness, Wall Switch	H8813	1	H8813	1
29	Wiring Harness, Jumper	H8809	1	H8809	1

 **WARNING**

Failure to position the parts in accordance with these diagrams or failure to use only parts specifically approved with this appliance may result in property damage or personal injury.

 **AVERTISSEMENT**

Risque de dommages ou de blessures si les pièces ne sont pas installées conformément à ces schémas et ou si des pièces autres que celles spécifiquement approuvées avec cet appareil sont utilisées.

REPLACEMENT PARTS

