



HEARTH PRODUCTS

P/N 506013-05 Rev. NC 11/2013

This manual is part of a set of two supporting this product. Refer to P/N 506011-05 for Installation Instructions.

Ce manuel est disponible en français, simplement en faire la demande. Numéro de la pièce 506223-69.

WHAT'S INSIDE

Table of Contents	2
Safety and Your Fireplace	2
FREE Safety Guard Offer (Protects Against Burns)	2
Important Safety Information	4
Attaching the Safety-in-Operation Warnings	5
[EN FRANÇAIS] L'information de sûreté importante	3-4
Apposition des mises en garde relatives à la sécurité d'utilisation	5
[EN ESPAÑOL] Información importante de seguridad	3-4
Colocación de advertencias de seguridad en operación	5

CARE AND OPERATION INSTRUCTIONS

EDV Direct-Vent Gas Fireplaces

ELITE® SERIES

MODELS		MILLIVOLT:	ELECTRONIC:
EDV35RNM	EDV35RPM	EDV35RNE	EDV35RNE
EDV40RNM	EDV40RPM	EDV40RNE	EDV40RNE
EDV45RNM	EDV45RPM	EDV45RNE	EDV45RNE



OTL Report No. 116-F-05d-5



**INSTALLER:** Leave this manual with the appliance.  
**CONSUMER:** Retain this manual for future reference.  
**INSTALLATEUR :** Laissez cette notice avec l'appareil.  
**CONSOMMATEUR :** Conservez cette notice pour consultation ultérieure.

! WARNING / AVERTISSEMENT / AVISO

<p><b>HOT GLASS WILL CAUSE BURNS. DO NOT TOUCH GLASS UNTIL COOLED. NEVER ALLOW CHILDREN TO TOUCH GLASS.</b></p>		<p><b>UNE SURFACE VITRÉE CHAUDE PEUT CAUSER DES BRÛLURES. LAISSER REFROIDIR LA SURFACE VITRÉE AVANT D'Y TOUCHER. NE PERMETTEZ JAMAIS À UN ENFANT DE TOUCHER LA SURFACE VITRÉE.</b></p>	<p><b>EL VIDRIO CALIENTE CAUSARÁ QUEMADURAS. USTED DEBE NUNCA TOCAR EL VIDRIO CALIENTE. LOS NIÑOS DEBEN NUNCA TOCAR EL VIDRIO.</b></p>
---	---	--	--

**WARNING:** If the information in these instructions is not followed exactly, a fire or explosion may result, causing property damage, personal injury, or death.

- Do not store or use gasoline or other flammable vapors and liquids in the vicinity of this or any other appliance.
- **WHAT TO DO IF YOU SMELL GAS:**
  - Do not try to light any appliance.
  - Do not touch any electrical switch; do not use any phone in your building.
  - Immediately call your gas supplier from a neighbor's phone. Follow the gas supplier's instructions.
  - If you cannot reach your gas supplier, call the fire department.
- Installation and service must be performed by a qualified installer, service agency or the gas supplier.

**AVERTISSEMENT :** Assurez-vous de bien suivre les instructions données dans cette notice pour réduire au minimum le risque d'incendie ou d'explosion ou pour éviter tout dommage matériel, toute blessure ou la mort.

- Ne pas entreposer ni utiliser d'essence ni d'autres vapeurs ou liquides inflammables dans le voisinage de cet appareil ou de tout autre appareil.
- **QUE FAIRE SI VOUS SENTEZ UNE ODEUR DE GAZ :**
  - Ne pas tenter d'allumer d'appareil.
  - Ne touchez à aucun interrupteur. Ne pas vous servir des téléphones se trouvant dans le bâtiment où vous trouvez.
  - Appelez immédiatement votre fournisseur de gaz depuis un voisin. Suivez les instructions du fournisseur.
  - Si vous ne pouvez rejoindre le fournisseur de gaz, appelez le service des incendies.
- L'installation et l'entretien doivent être assurés par un installateur ou un service d'entretien qualifié ou par le fournisseur de gaz.

## ACCESSORY COMPONENTS

Product Reference Information			
Cat. No.	Model	Ship. Weight	Ship. Volume
H9026	EDV35RNM	78 lb.	9.09 cu. ft.
H9027	EDV35RPM	78 lb.	9.09 cu. ft.
H9028	EDV35RNE	78 lb.	9.09 cu. ft.
H9029	EDV40RNM	86 lb.	10.61 cu. ft.
H9030	EDV40RPM	86 lb.	10.61 cu. ft.
H9031	EDV40RNE	86 lb.	10.61 cu. ft.
H9032	EDV45RNM	108 lb.	14.01 cu. ft.
H9033	EDV45RPM	108 lb.	14.01 cu. ft.
H9034	EDV45RNE	108 lb.	14.01 cu. ft.



### State-of-the-art control with touch screen operation

- Backlit LCD display
- Wall mounted docking station for the transmitter
- Thermostatic or manual ON/OFF
- Programmable Weekday/Weekend modes
- Flame icon and low battery indicator
- Receiver may be wall mounted or placed in the valve compartment
- Includes batteries

Remote, Touch Screen, Thermostat, On/Off		
Cat. No.	Model No.	Description
H8865	RC-S-TOUCH	Remote Control

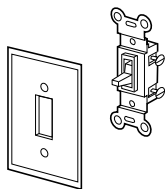

### ON/OFF Wall Switch Kit

The ON/OFF wall switch may be used to control the operation of the fireplace burner as an alternative to the optional unit-mountable ON/OFF rocker switch. Install the wall switch in a convenient location near the fireplace.

ON/OFF Wall Switch		
Cat. No.	Model No.	Description
85L87	FWSK	ON/OFF Wall Switch



### Thermostatic or Manual modes

- LCD Display
- Up to 9 hour Count down Timer
- Includes batteries
- Child lock
- Low battery indicator
- Receiver may be wall mounted or placed in the valve compartment

Remote, LCD Stat, Thermostat, On/Off		
Cat. No.	Model No.	Description
H8861	RC-S-STAT	Remote Control



### Flame and Heat modulation

- Includes solenoid for SIT millivolt valves
- Thermostatic, manual or up to 9 hour Countdown Timer modes
- 3 Fan speed settings
- Child lock
- Low battery indicator
- Wall clip included
- Includes batteries

Remote With Hi/Low Flame, Millivolt		
Cat. No.	Model No.	Description
H8862	RC-S-MODMV	Remote Control



### Cost Effective Solution

- Simple On/Off operation
- Works with millivolt and low voltage electronic ignition controls

Kit includes:  
Remote and Receiver

G-Fire Remote, Simple On/Off		
Cat. No.	Model No.	Description
H8840	KIT-RC-G-FIRE	Remote Control



### Wall Thermostat

- Wall surface mounted
- Thermostat or manual ON/OFF operation
- Large LCD screen to display room and set temperature in °F and °C
- Connects to wall switch wire

Wall Thermostat, On/Off and Thermostatic functions		
Cat. No.	Model No.	Description
H8864	WS-S-TSTAT	Wall Thermostat



### Wall Control

- 4-button timer with 30/60/120/OFF minutes
- Wall surface mounted
- Connects to wall switch wire
- Perfect for rental and resort applications

Wall Switch, Countdown Timer		
Cat. No.	Model No.	Description
H8863	WS-S-TMR	Wall Switch

## ACCESSORY COMPONENTS CONTINUED



### Manual or up to 3 hr Countdown Timer modes

- LCD display
- Displays room temp. in °F or °C
- Flame icon and low battery indicator
- Includes batteries
- Wall clip included
- Receiver may be wall mounted or placed in the control compartment
- Includes white face plate
- Flame icon
- Low battery indicator
- Batteries included

#### Remote, Two Button, Timer, On/Off Or Timer Mode

Cat. No.	Model No.	Description
H8860	RC-S-1	Remote Control

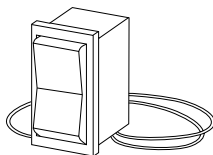

### Unit-Mountable ON/OFF Rocker Switch Kit (Millivolt systems only)

The rocker switch may be used to provide ON/OFF operation as an alternative to the optional wall switch. The rocker switch installs directly in the gas valve mounting bracket (millivolt gas valve-equipped fireplaces only).

#### Rocker Switch Kit

Cat. No.	Model No.	Description
80L41	FRS	Rocker Switch Kit

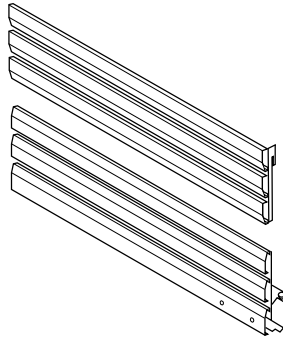

#### Black Louvers

Model No.	Catalog No. Model No.	
	Top Louver Kit	Bottom Louver Kit
EDV35	H6337	H6344
EDV40	H2727	H6345
EDV45	H3146	H6346

These louvers are designed to replace the standard radiant panels that are provided with the appliance.

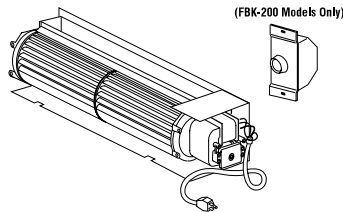

#### Blower Kits

Cat. No.	Model No.	Description
80L84	FBK-100	Single Speed
80L85	FBK-200	Variable Speed with wall-mountable switch
80L86	FBK-250	Heat activated variable speed with unit mounted switch

### Forced Air Kit

The FBK-100 blower provides constant velocity forced air circulation. The FBK-200 assembly with variable speed, wall-mountable switch provides variable speed forced air circulation. The FBK-250 assembly with heat activation and a unit mounted switch which provides variable speed forced air circulation.

Termination Shroud (Fits H1968)

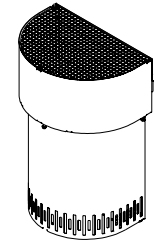

Deluxe Termination Guard (Fits 94L10)

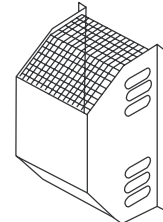

Square Termination Guard (Fits 94L10)

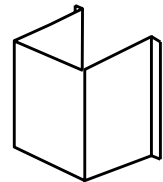

### Termination Guard Kits

The vent termination guards may be used to cover the vent termination on the exterior of the home to minimize exposure to the hot surface of the termination.

#### Termination Guard Kits (all models)

Cat. No.	Model No.	Description
H5820	4.5HTSK	Termination Shroud
87L02	SV4.5HGS	Termination Guard, Deluxe
17M52	SV4.5HGS-1	Termination Guard, Square



### Touch-Up Paint Kit

Repair of minor scratches and discoloration of the appliance painted surfaces may be accomplished with the touch-up paint kit.

#### Touch-Up Paint (Black) Kit

Cat. No.	Model No.	Description
90L73	TPK-B	Touch-Up Paint

**ACCESSORY COMPONENTS CONTINUED**

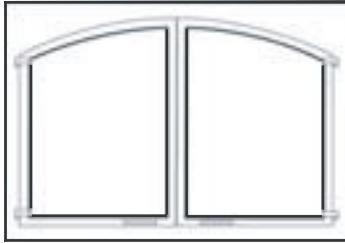

**Arch Design**



**Arch Pane Design**

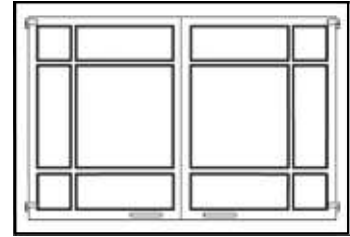

**Square Pane Design**

**Style View Doors -**

Style View Doors come in three beautiful styles. They are easy to install. The door includes heavy duty magnet door latches and functional twin-pane doors.

<b>ARCH DESIGN KITS</b>			
Cat. No.	Model	Description	Model Series
H9143	AD35EB-2	Arch Doors, Black	EDV35
H9144	AD35ESP-2	Arch Doors, Satin Pewter	
H8771	AD40B-2	Arch Doors, Black	EDV40
H8772	AD40SP-2	Arch Doors, Satin Pewter	
H8773	AD45B-2	Arch Doors, Black	EDV45
H8774	AD45SP-2	Arch Doors, Satin Pewter	
<b>ARCH PANE DESIGN KITS</b>			
H9145	APD35B-2	Arch Pane Doors, Black	EDV35
H9146	APD35ESP-2	Arch Pane Doors, Satin Pewter	
H8777	APD40B-2	Arch Pane Doors, Black	EDV40
H8778	APD40SP-2	Arch Pane Doors, Satin Pewter	
H8779	APD45B-2	Arch Pane Doors, Black	EDV45
H8780	APD45SP-2	Arch Pane Doors, Satin Pewter	

<b>SQUARE PANE DESIGN KITS</b>			
Cat. No.	Model	Description	Model Series
H9147	SPD35EB-2	Sq. Pane Doors, Black	EDV35
H9148	SPD35SP-2	Sq. Pane Doors, Satin Pewter	
H8783	SP40B-2	Sq. Pane Doors, Black	EDV40
H8784	SP40SP-2	Sq. Pane Doors, Satin Pewter	
H8785	SP45B-2	Sq. Pane Doors, Black	EDV45
H8786	SP45SP-2	Sq. Pane Doors, Satin Pewter	

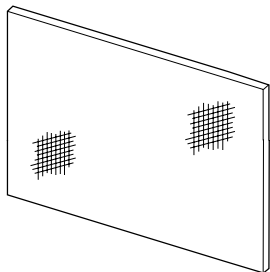

These barrier screen kits create a barrier to prevent direct contact with the hot glass. The screen panel affixes directly to the front glass enclosure panel.

<b>Barrier Screen Kits</b>	
Model No.	Catalog No. Model No.
EDV35	88L52 HGE35
EDV40	96K32 HG40
EDV45	96K33 HG45



**Bag of Glowing Embers**

**Bag of Decorative Volcanic Stone**

Replacement ember material and volcanic stone is available for use with these appliances. Order to replace materials as part of the periodic maintenance of the appliance.

<b>Firebox Accessories / Parts</b>		
Cat. No.	Model No.	Description
88L53	FGE	Bag of Glowing Embers
80L42	FDVS	Bag of Decorative Volcanic Stone

**ACCESSORY COMPONENTS CONTINUED**

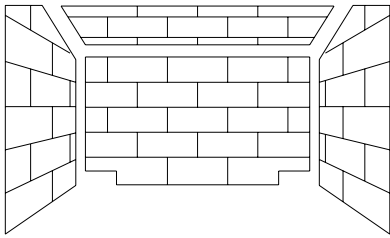

The firebox liner kits include ceramic panels of the side walls, the rear and the baffle of the firebox. The panels have brick-like features in relief.

Firebox Liner Kits		
Cat. No.	Model	Description
H0775	EBLK-35	35 -Buff Rustic
H2025	EBLKH-35	35 - Buff Herringbone
H0776	EBLK-40	40 - Buff Rustic
H2026	EBLKH-40	40 - Buff Herringbone
H0777	EBLK-45	45 - Buff Rustic
H2027	EBLKH-45	45 - Buff Herringbone

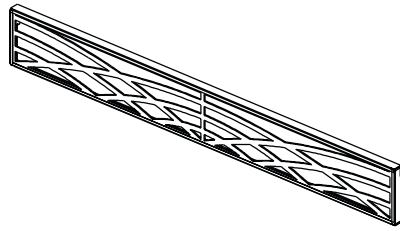

**Grill Kits**

The distinctive sunrise design grille is available in black or satin pewter finish. This grill may be used to replace the standard radiant panels or optional louvered panels. Upper and lower grille are sold separately.

Sunrise Grill Kits			
Cat. No.	Model	Description	
H3565	SUGK35C	35" Sunrise Upper Grill Kit, Black	EDV35
H3567	SUGK35SP	35" Sunrise Upper Grill Kit, Satin Pewter	
H3569	SLGK35C	35" Sunrise Lower Grill Kit, Black	
H3571	SLGK35SP	35" Sunrise Lower Grill Kit, Satin Pewter	EDV40
H3573	SUGK40C	40" Sunrise Upper Grill Kit, Charcoal	
H3575	SUGK40SP	40" Sunrise Upper Grill Kit, Satin Pewter	
H3577	SLGK40C	40" Sunrise Lower Grill Kit, Black	EDV45
H3579	SLGK40SP	40" Sunrise Lower Grill Kit, Satin Pewter	
H3581	SUGK45C	45" Sunrise Upper Grill Kit, Black	
H3583	SUGK45SP	45" Sunrise Upper Grill Kit, Satin Pewter	EDV45
H3585	SLGK45C	45" Sunrise Lower Grill Kit, Black	
H3587	SLGK45SP	45" Sunrise Lower Grill Kit, Satin Pewter	

## REPLACEMENT PARTS LIST

Item No.	Description	EDV35		EDV40		EDV45	
		Part No.	Qty.	Part No.	Qty.	Part No.	Qty.
1	Hood	97K51	1	97K52	1	97K53	1
4	Enclosure, Glass Front (Complete)	91L18	1	H8122	1	H6225	1
6	Door Latch Spring	H1264	2	H1264	2	H1264	2
7	Nameplate (Brand)	12L15	1	12L15	1	12L15	1
9	Catch, Door, Magnetic	69L31	1	69L31	1	69L31	1
10	Log Set (Complete)	55M02	1	55M03	1	55M03	1
11	Burner Assembly	55M29	1	H3044	1	H3044	1
12	Grate Assembly	H6604	1	H6605	1	H6605	1
13	Venturi/Air Shutter	H6321	1	H6321	1	H6321	1
14	Orifice, Main Burner - Nat. Gas	H3721	1	69L96	1	24M10	1
14	Orifice, Main Burner - LP Gas	H8998	1	39L10	1	21L01	1
16	Bag of Glowing Embers (rockwool)	88L53	1	88L53	1	88L53	1
19	Gasket - Venturi Tube Mounting	43K85	1	43K85	1	43K85	1
20	Gas Line Flexible Connector	93L32	1	93L32	1	93L32	1
21	Magnet	H3699	1	H3699	1	H3699	1
22	Radiant Panel Assembly, Upper	H8661	1	H8662	1	H8663	1
23	Radiant Panel Assembly, Lower	H8665*	1	H8666*	1	H8667*	1

Gas Controls - SIT Millivolt					
Item No.	Description	Natural Gas		Propane Gas	
		Part No.	Qty.	Part No.	Qty.
30	Gas Valve, SIT	H6209	1	88J53	1
31	Piezo Igniter	10K86	1	10K86	1
32	Pilot Assembly	69L17	1	69L18	1
33	Pilot Generator	60J79	1	60J79	1
34	Thermocouple	74L57	1	74L57	1
35	Pilot Tube	74L56	1	74L56	1
36	Electrode And Cable	H6212	1	H6212	1

Gas Controls - SIT Electronic					
Item No.	Description	Natural Gas		Propane Gas	
		Part No.	Qty.	Part No.	Qty.
40	Gas Valve, SIT	H8844	1	H8594	1
41	Pilot Assembly	H7268	1	H7269	1
42	Transformer	H8006	1	H8006	1
---	Pilot Shield	H3737	1	H3737	1
43	Digital Flame Control Module	H7272	1	H7272	1
---	Battery Holder	H8803	1	H8803	1
---	DFC Wiring Harness	H8601	1	H8601	1
17	CPI On/Off Switch	27K30	1	27K30	1

\* Lennox Nameplate Logo, 12L15, is not included.

### WARNING

Failure to position the parts in accordance with these diagrams or failure to use only parts specifically approved with this appliance may result in property damage or personal injury.

### AVERTISSEMENT

Risque de dommages ou de blessures si les pièces ne sont pas installées conformément à ces schémas et ou si des pièces autres que celles spécifiquement approuvées avec cet appareil sont utilisées.

Contact an Lennox Hearth Products dealer to obtain any of these parts. Never use substitute materials. Use of non-approved parts can result in poor performance and safety hazards.

# REPLACEMENT PARTS

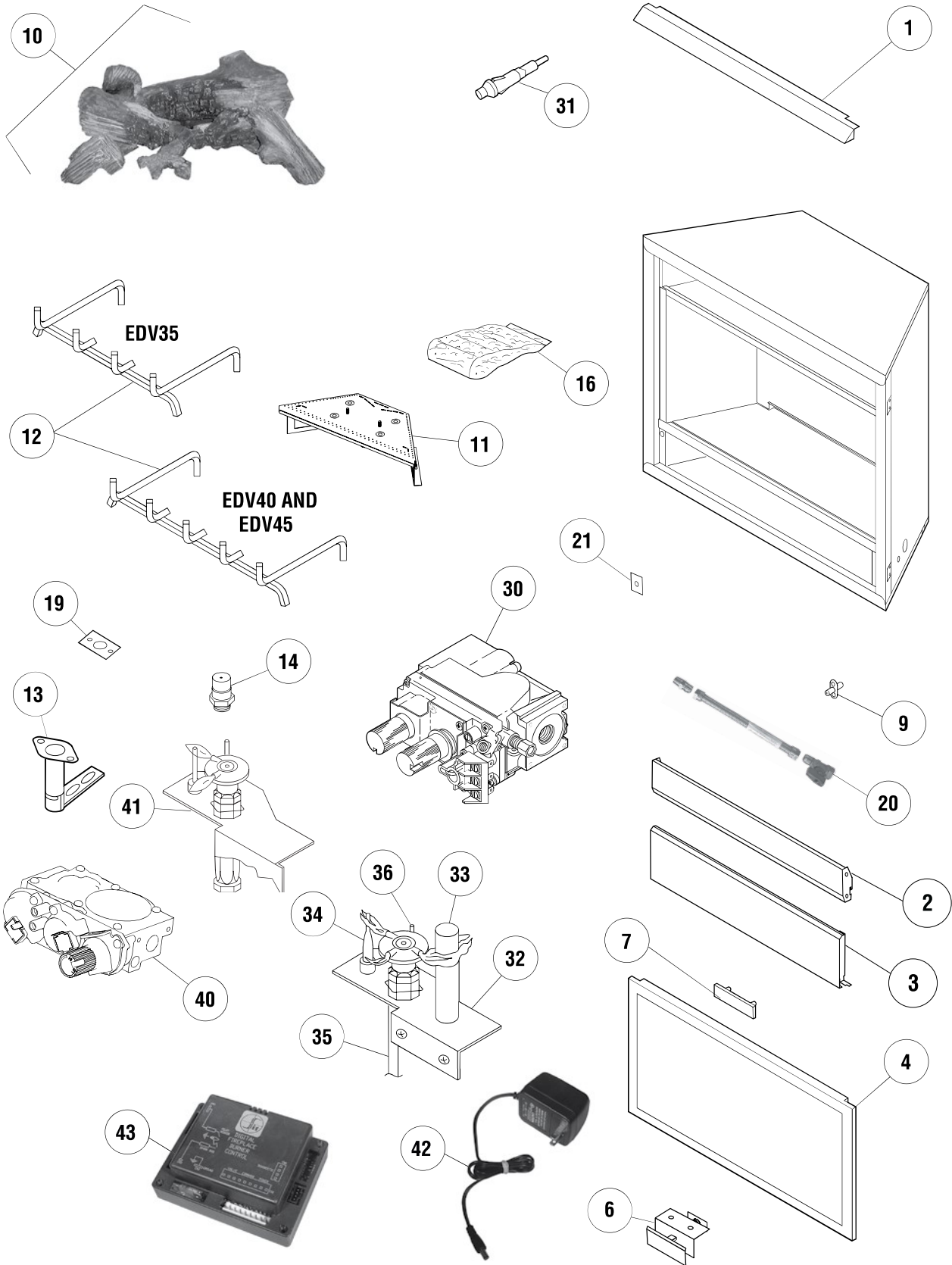

NOTE: DIAGRAMS & ILLUSTRATIONS ARE NOT TO SCALE.