

Illustrated Parts Breakdown

VICTORY
Rear-Tine Tiller

Model #: 29409

ENGLISH

FRENCH

S/N

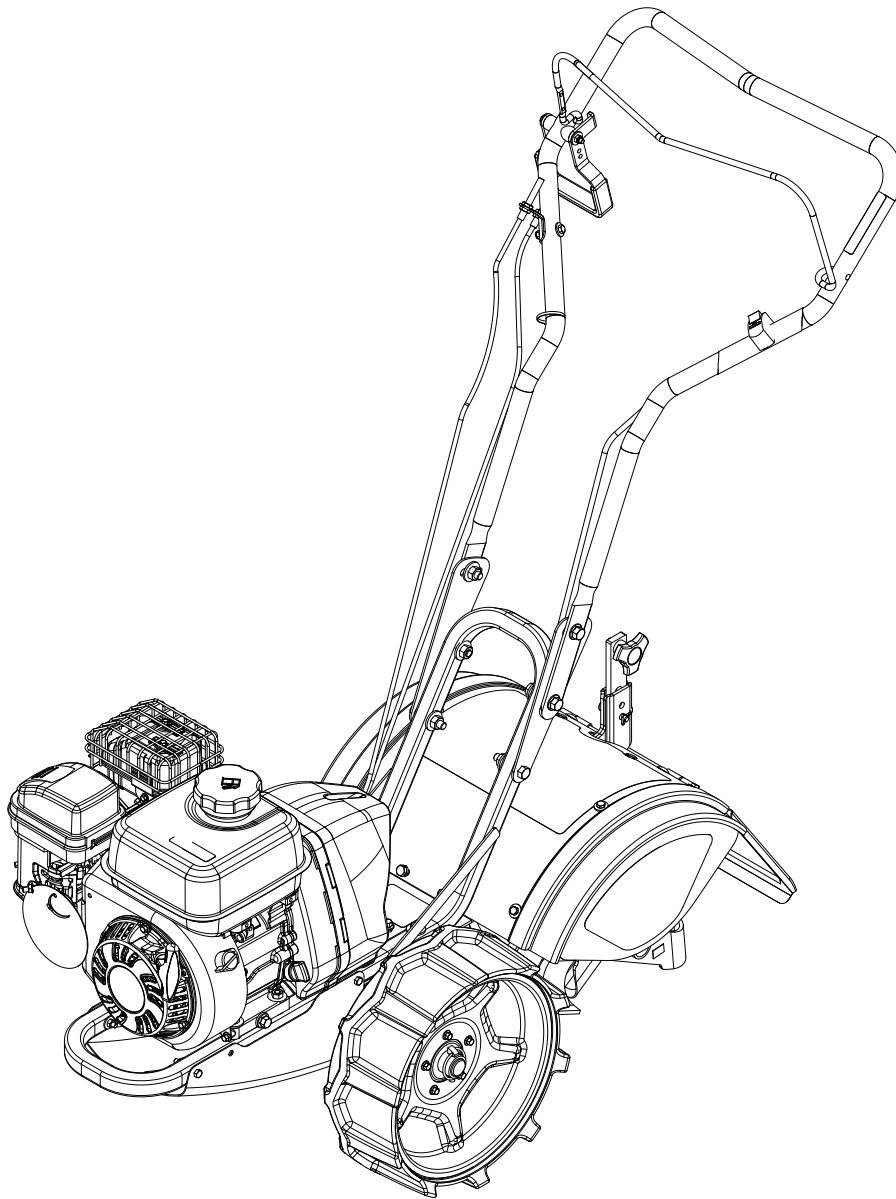

ILLUSTRATED PARTS BREAKDOWN: Handlebar Assembly

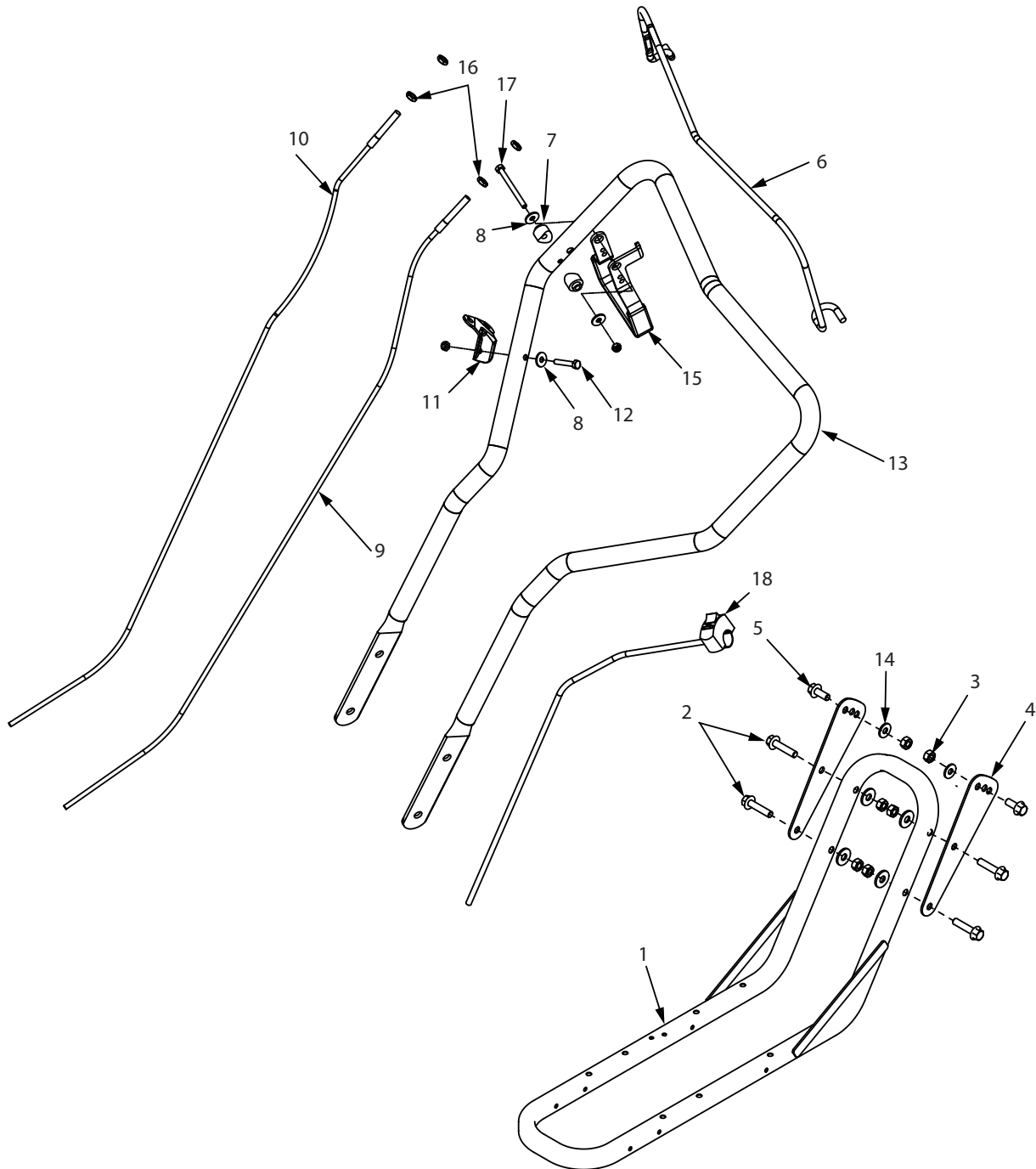

ILLUSTRATED PARTS LIST: Handlebar Assembly

ITEM #	PART #	DESCRIPTION	QTY
N.º DE ELEMENTO	N.º DE PIEZA	DESCRIPCIÓN	CANT.
1	19867	ENGINE MOUNT	1
2	11509	BOLT M 10 X 45	4
3	W1265V0903	NUT M10	6
4	13285	HANDLEBAR ADJUSTMENT PLATE	2
5	19124	BOLT M10 X 25	2
6	24603	FORWARD DRIVE LEVER	1
7	24610	REVERSE HANDLE SPACER	2
8	20141	WASHER M6	3
9	24606	REVERSE CABLE	1
10	24605	FORWARD CABLE	1
11	25490	CABLE BRACKET	1
12	18104	BOLT M6 X 35	1
13	24602	HANDLEBAR	1
14	19905	WASHER M10	6
15	25744	REVERSE DRIVE LEVER	1
16	4620	NUT M8	4
17	25755	BOLT M6 X 70	1
18	32431	ASSEMBLY SWITCH	1

ILLUSTRATED PARTS BREAKDOWN: Engine and Mount 1

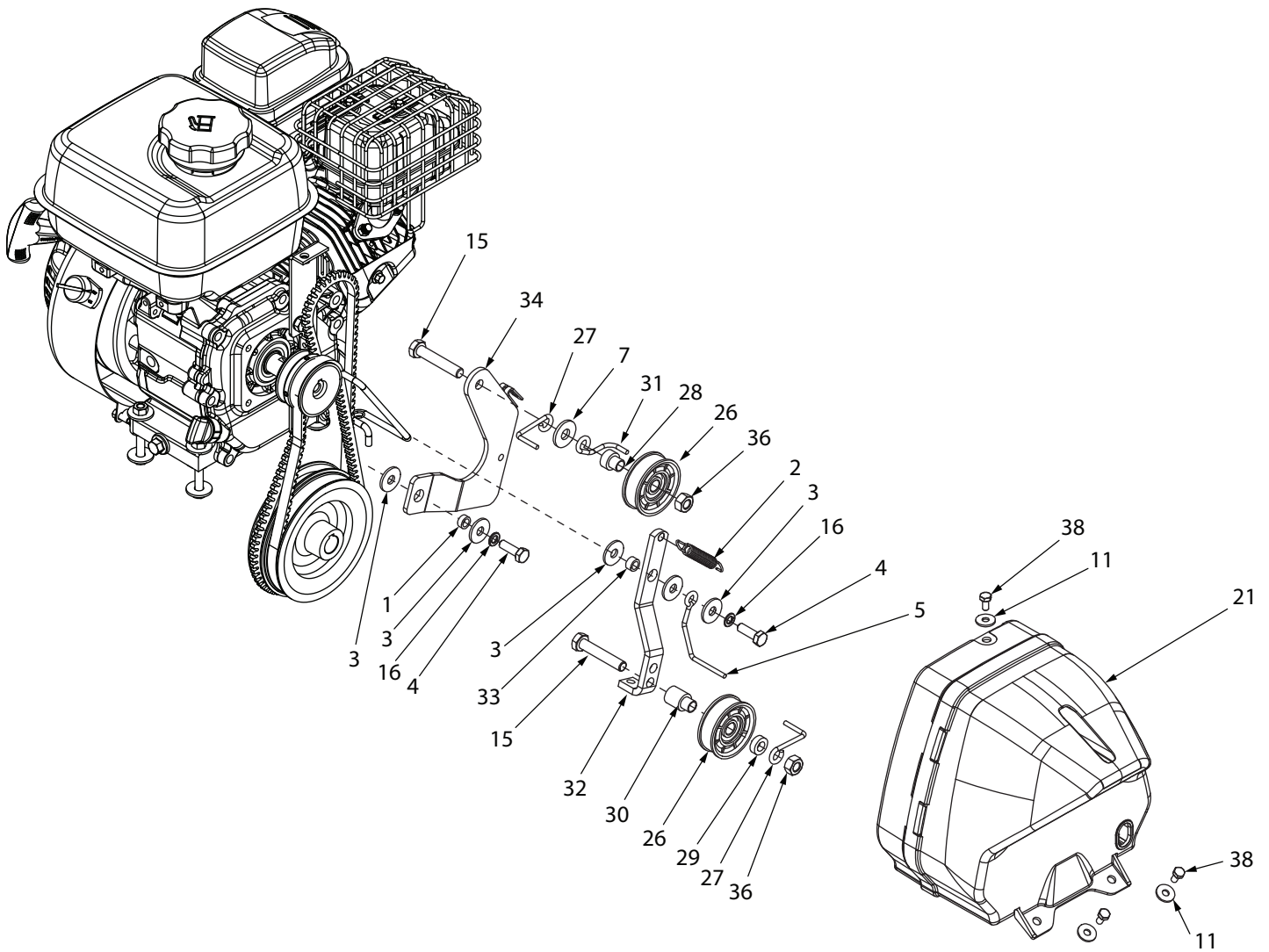

ILLUSTRATED PARTS BREAKDOWN: Engine and Mount 2

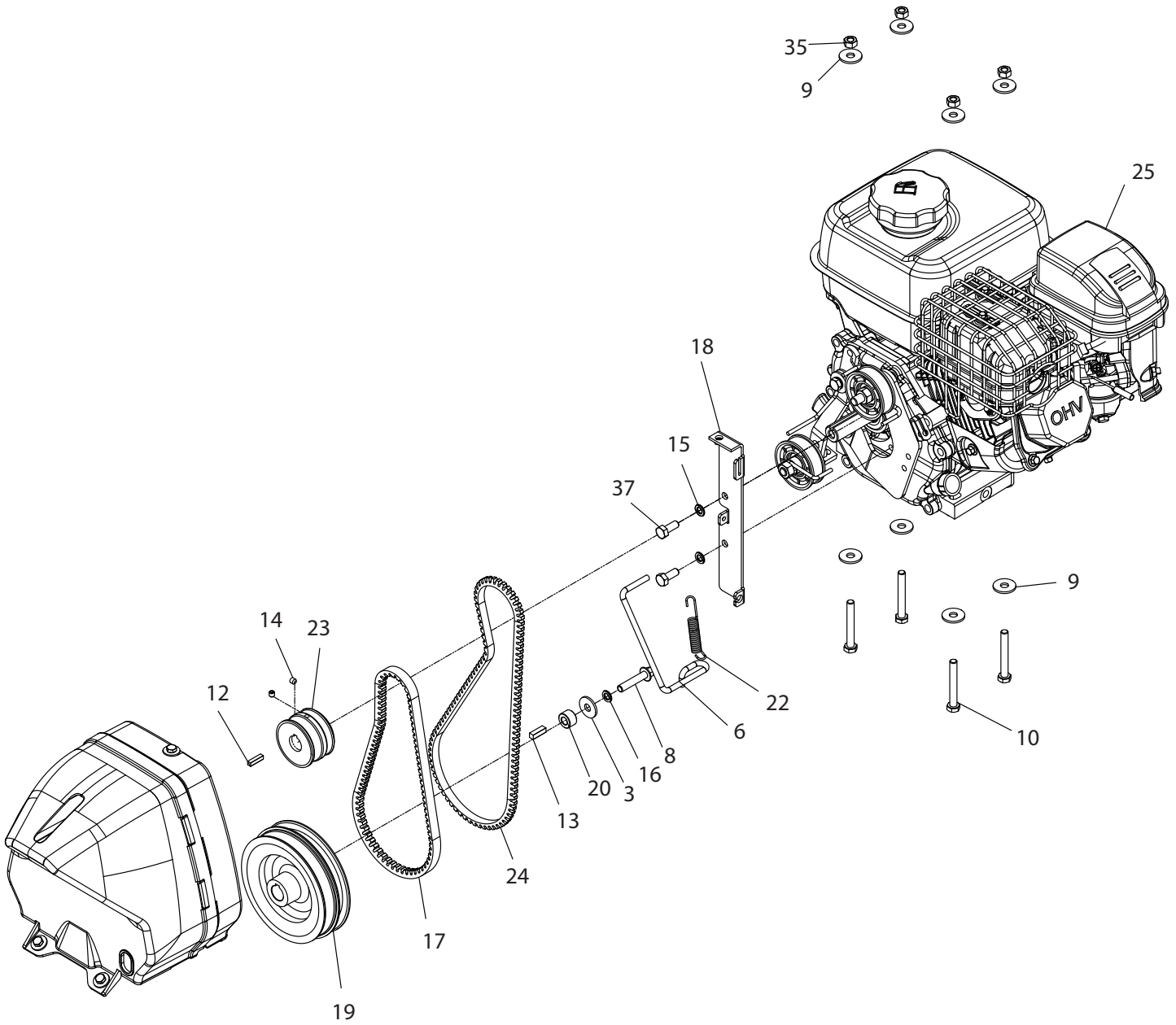

ILLUSTRATED PARTS LIST: Engine and Mount

ITEM #	PART #	DESCRIPTION	QTY
N.º DE ELEMENTO	N.º DE PIEZA	DESCRIPCIÓN	CANT.
1	743	REVERSE ARM BUSHING	1
2	1407	FORWARD ARM SPRING	1
3	3245	WASHER M8	6
4	13826	BOLT M8 X 25	2
5	14030	BELT GUIDE	1
6	19895	BELT GUIDE	1
7	19905	WASHER M10	1
8	19922	BOLT M8 X 40	1
9	20143	WASHER M8	8
10	20144	BOLT M8 X 60	4
11	20148	WASHER M6	3
12	20176	ENGINE PULLEY KEY	1
13	20197	TRANSMISSION PULLEY KEY	1
14	20919	SET SCREW M6 X 8	2
15	21600	BOLT M10 X 55	2
16	21640	WASHER M8	5
17	22773	BELT 4LXA 12MM X 660MM	1
18	24614	CABLE MOUNT PLATE	1
19	24616	TRANSMISSION PULLEY	1
20	24617	DRIVE SHAFT SPACER	1
21	24771	BELT GUARD	1
22	24885	REVERSE ARM SPRING	1
23	24950	ENGINE PULLEY	1
24	24995	BELT 4LXA 10MM X 812MM	1
25	31776	ENGINE R210 212CC	1
26	25881	IDLER PULLEY	2
27	25885	BELT GUIDE	2
28	25888	REVERSE PULLEY SPACER LONG	1
29	25889	REVERSE PULLEY SPACER SHORT	1
30	25890	FORWARD PULLEY SPACER	1
31	26564	BELT GUIDE	1
32	53617	FORWARD ARM	1
33	53637	FORWARD ARM BUSHING	1
34	53682	REVERSE ARM	1
35	W1265V0900	NUT M8	4
36	W1265V0903	NUT M10	2
37	W1265V0904	BOLT M8 X 20	2
38	W1200115	BOLT M6 X 12	3

ILLUSTRATED PARTS LIST: Transmission Breakdown

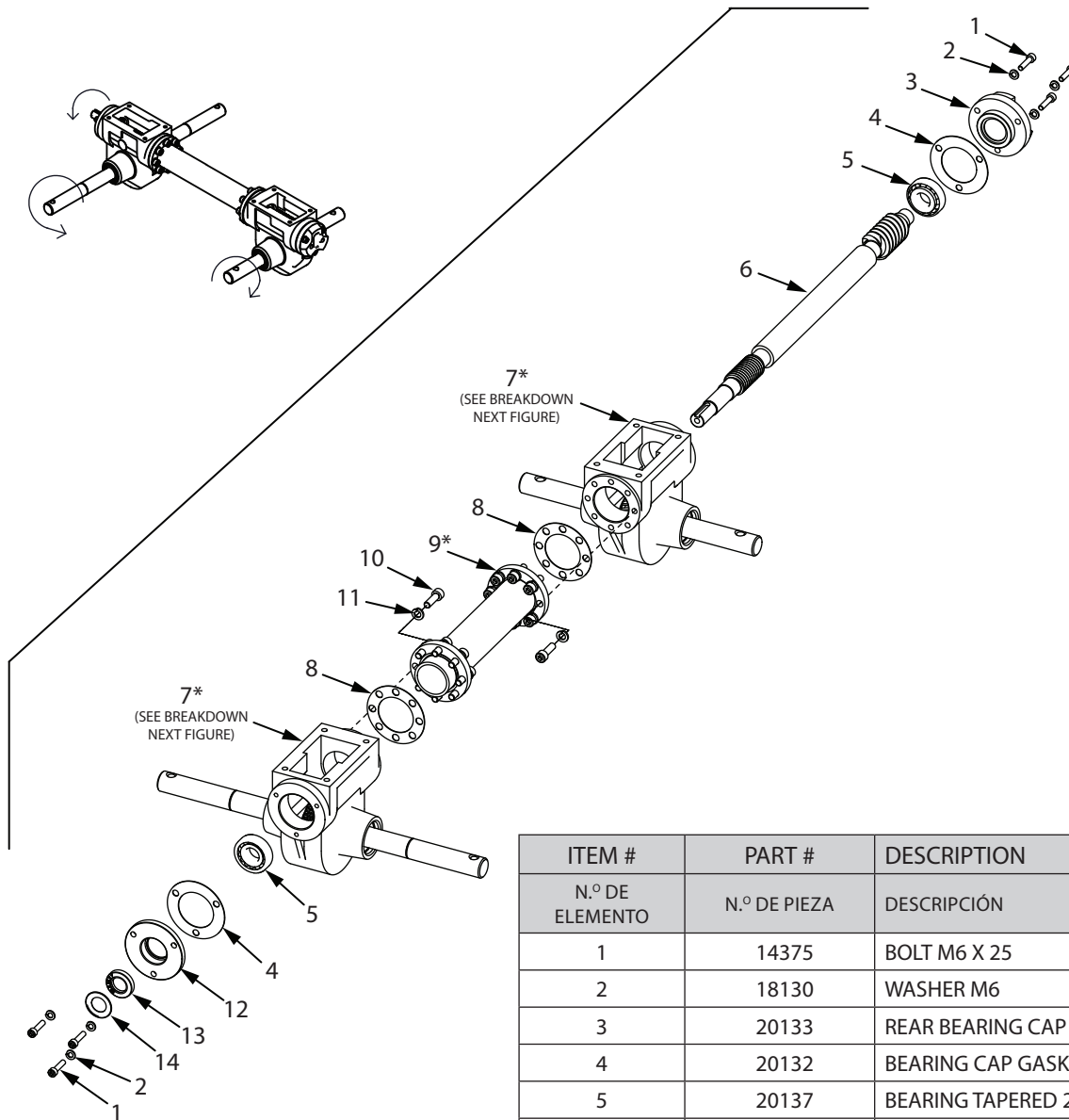

ITEM #	PART #	DESCRIPTION	QTY
N.º DE ELEMENTO	N.º DE PIEZA	DESCRIPCIÓN	CANT.
1	14375	BOLT M6 X 25	6
2	18130	WASHER M6	6
3	20133	REAR BEARING CAP	1
4	20132	BEARING CAP GASKET	2
5	20137	BEARING TAPERED 20MM ID X 47MM OD	2
6	19993	CRT DRIVE SHAFT	1
7	*	CAST TRANSMISSION HOUSING	2
8	14028	TRANSMISSION HOUSING GASKET	2
9	*	FLANGED PIPE	1
10	400022	BOLT M8 X 25	16
11	W1200114	WASHER M8	16
12	20134	FRONT END CAP	1
13	20136	DRIVE SHAFT SEAL 20MM X 35MM	1
14	20131	DRIVE SHAFT SEAL COVER	1

* ORDER TRANSMISSION ASSEMBLY 20111

ILLUSTRATED PARTS BREAKDOWN: Transmission, Tines and Hood

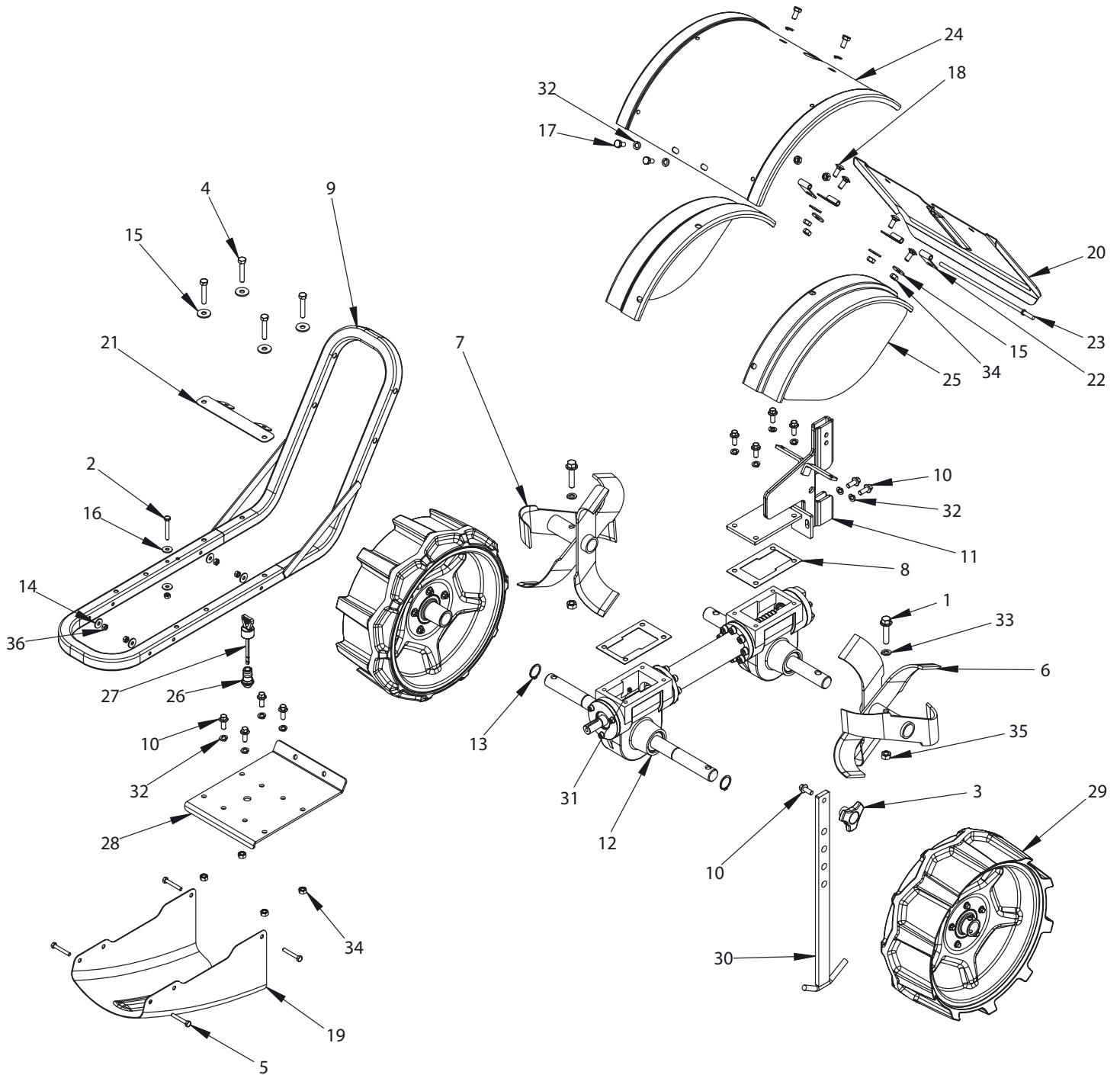

ILLUSTRATED PARTS LIST: Transmission, Tines and Hood

ITEM #	PART #	DESCRIPTION	QTY
N.º DE ELEMENTO	N.º DE PIEZA	DESCRIPCIÓN	CANT.
1	11509	BOLT M10 X 45	2
2	11946	BOLT M6 X 45	1
3	13601	KNOB M8	1
4	18098	BOLT M8 X 45	4
5	18103	BOLT M6 X 40	4
6	1900LCRT	LEFT TINE SET	1
7	1900RCRT	RIGHT TINE SET	1
8	19864	TRANSMISSION COVER GASKET	2
9	19867	ENGINE MOUNT	1
10	19945	BOLT M8 X 20	11
11	20003	TAIL MOUNT	1
12	20111	CRT TRANSMISSION	1
13	20138	SNAP RING 25MM	2
14	20141	WASHER M6	5
15	20143	WASHER M8	8
16	20148	WASHER M6	1
17	20150	BOLT M8 X 15	4
18	23205	BOLT M8 X 20	4
19	24764	LOWER PAN	1
20	24778	BEAVER TAIL	1
21	24782	BELT GUARD MOUNT	1
22	24868	HINGE BRACKET	4
23	24869	HINGE ROD	1
24	24870	TINE HOOD	1
25	24873	SIDE SHIELD	2
26	24877	TRANSMISSION VENT M16	1
27	24879	TRANSMISSION DIPSTICK	1
28	24880	TINE HOOD MOUNT	1
29	28365	TIRE	2
30	53655	CRT DRAG STAKE	1
31	"OIL00"	MYSTIC CL 00 GREASE (760 GRAMS)	1
32	W1200114	WASHER M8	14
33	W1200119	WASHER M10	2
34	W1265V0900	NUT M8	10
35	W1265V0903	NUT M10	2
36	W1265V0913	NUT M6	5

ILLUSTRATED PARTS LIST: Transmission Breakdown

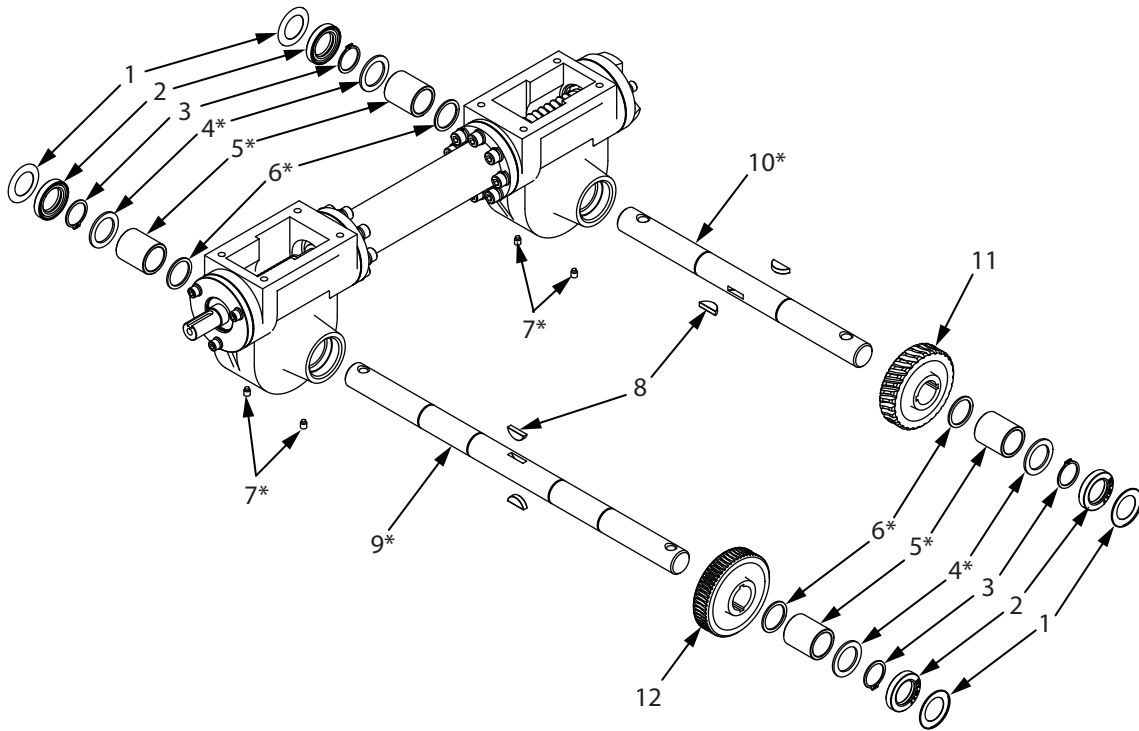

ITEM #	PART #	DESCRIPTION	QTY
N.º DE ELEMENTO	N.º DE PIEZA	DESCRIPCIÓN	CANT.
1	20130	AXLE SHAFT SEAL COVER	4
2	20135	AXLE SHAFT SEAL 25MM X 40MM	4
3	20138	SNAP RING 25MM	4
4	*	SHIM 37 X 26 X 2 MM	4
5	*	BUSHING 25 X 32 X 36.5 MM	4
6	*	SHIM 26 X 32 X 1.5 MM	4
7	*	SETSCREW M6 X 8.5	4
8	1500P113	GEAR KEY	4
9	*	WHEEL AXLE	1
10	*	TINE AXLE	1
11	20128	TINE GEAR 30 TOOTH	1
12	19982	WHEEL GEAR 61 TOOTH	1
* ORDER TRANSMISSION ASSEMBLY 20111			