



WHEELED GAS COMPRESSOR

OPERATION MANUAL

BEPOWEREQUIPMENT

.COM



TABLE OF CONTENTS

Introduction

4 Using the Operators Manual

Specifications

4 Specifications

Product Identification

5 Record Identification Numbers

Safety

6 Safety Instructions

7 Safety Rules

7 Hazard Symbols and Meanings

10 General Safety Information

Safety & Installation

11 Spraying Precautions

11 Hose Precautions

11 Installation and Location

11 Extension Cords

Assembly Instructions

12 Assembly

Product Features

13 Automatic ON/OFF

13 Regulator

13 Tank Pressure Gauge

13 Safety Valve

13 Tank Drain Fitting

13 Safety Guard



Operating Instructions

- 14 Initial Start Up
- 14 Start Up
- 14 Storage
- 14 Shut Down

Maintenance

- 15 When performing any maintenance or service
- 15 Daily
- 15 Weekly
- 15 Monthly
- 15 Six Months or 250 Operating Hours
- 15 Oil Change

Troubleshooting

- 16 Troubleshooting Chart

Parts

- 17 Engine Parts Diagram and List
- 18 Pump Diagram
- 19 Pump List



INTRODUCTION



Attention: Read through the complete manual prior to the initial use of your compressor.

Using the Operator's manual

Thank you for choosing our compressor. The manual gives information with respect to operation and maintenance of the Compressor and be sure to read it carefully first before operation.

Following the manual can ensure the user's safety and get the best results from the compressor. All information and diagrams in this manual are in accordance with the newest products at the publishing time. We strive for accuracy and this manual is accurate for the models described at the time of printing. We reserve the right to make improvements or changes at any time without notice or obligation.

Please keep this manual with the engine permanently, even if the engine ownership is transferred.



Record Identification Numbers

COMPRESSOR

If you need to contact an Authorized Dealer or Customer Service line (1-866-850-6662) for information on servicing, always provide the product model and identification numbers.

You will need to locate the model and serial number for the machine and record the information in the places provided below.

Date of Purchase:

Dealer Name:

Dealer Phone:

Product Identification Numbers

Model Number:

Serial Number:



SAFETY

Safety Instructions

- Carefully read through the entire owners manual before operating this compressor.
- Keep manual with important records for safety instructions, operating procedures and warranty.
- After unpacking your new air compressor, please inspect it carefully for any damage that may have occurred during transit.
- Do not operate this air compressor if damaged during shipment, handling or misuse.
- Damage may result in bursting, which can cause serious injury or property damage.
- All damaged parts must be repaired or replaced as needed prior to operating this air compressor.
- Check to see that all nuts, bolts and fittings are secure.
- Check to see that the proper lubrication oil, which has been included with the air compressor, is used to fill the compressor crankcase to the proper level.
- Please contact our customer service department at the numbers listed on the back of this instruction manual for any questions or comments regarding this air compressor.

Save these Instructions

SAFETY RULES



This is the safety alert symbol. It is used to alert you to potential personal injury hazards. Obey all safety messages that follow this symbol to avoid possible injury or death.

The safety alert symbol (▲) is used with a signal word (DANGER, CAUTION, WARNING), a pictorial and/or a safety message to alert you to hazards.













DANGER indicates a hazard which, if not avoided, will result in death or serious injury.

WARNING indicates a hazard which, if not avoided, could result in death or serious injury.

CAUTION indicates a hazard which, if not avoided, might result in minor or moderate injury.

NOTICE indicates a situation that could result in equipment damage. Follow safety messages to avoid or reduce the risk of injury or death.

HAZARD SYMBOLS AND MEANINGS

			
EXPLOSION	FIRE	ELECTRIC SHOCK	TOXIC FUMES
			
KICKBACK	HOT SURFACE	WEAR EYE PROTECTION	SLIPPERY
			
FALL	FLUID INJECTION	MOVING PARTS	READ MANUAL

WARNING



AIR TANK WARNING: Drain liquid from air tank daily, or after each use, using the drain valve located on the bottom of the lower air tank. Failure to properly drain liquid from the tank will cause rust from moisture build-up, which weakens the tank and could lead to a violent tank explosion. Periodically inspect the tanks for unsafe conditions such as corrosion.

Never attempt to repair or make modifications to the tank or its attachments. Welding, drilling or any other modifications may weaken the tank, which may result in damage from rupture or explosion. Never remove or attempt to adjust the pressure switch, safety valve, or other factory set operating pressures.

WARNING



FIRE WARNING: Avoid dangerous environments. Do not use compressor near gasoline or other flammable materials. Keep work area well lit. Normal sparking of a motor or sparking from grinding metal could ignite fumes. Do not spray flammable materials in the vicinity of an open flame or other ignition source, including the air compressor itself. Do not direct paint or other spray material towards the compressor.

Read and follow all safety instructions for the material you are spraying. Be sure to use an approved respirator designed for use with your specific application.

WARNING



BREATHABLE AIR WARNING: This air compressor is not designed, nor intended for the supply of breathable quality air. Air produced by this unit may contain carbon monoxide or other toxic vapors.

Do not inhale air from the compressor or from a breathing device connected to it.

 **WARNING**

AIR TOOLS AND ACCESSORIES WARNING: Do not exceed the pressure rating of any air tools, spray guns, air accessories, or inflatables. Excess pressure can cause them to explode, resulting in serious injury. Follow the manufacturers recommended pressure settings for all air tools and air accessories.

 **WARNING**

Do not direct compressed air stream at people or pets. The powerful compressed air stream can damage exposed skin and easily propel loose dirt and other small objects. Always wear eye protection that meets ANSI Z28.1 specifications.

 **WARNING**

Keep hands and fingers away from exposed metal parts on a running air compressor. Air compressors generate significant heat during normal operation, which can cause serious burns. The compressor will remain hot for some time after operation and should not be touched or moved until cool.

WARNING: This product can expose you to chemicals including lead, which is known to the State of California to cause cancer and birth defects or other reproductive harm. For more information, go to www.P65Warnings.ca.gov. Wash hands after handling.





GENERAL SAFETY INFORMATION

Do not operate unit if damaged during shipping, handling or use. Damage may result in bursting and cause injury or property damage.

Since the air compressor and other components (filters, lubricators, hoses, etc.) used, make up a high pressure pumping system, the following safety precautions must be observed at all times:



1. Read all manuals included with this product carefully. Be thoroughly familiar with the controls and the proper use of the equipment.
2. Follow all local electrical and safety codes
3. Only persons well acquainted with these rules of safe operation should be allowed to use the compressor.
4. Keep visitors away and NEVER allow children in the work area.
5. Wear safety glasses and use hearing protection when operating the pump or unit.
6. Do not stand on or use the pump or unit as a handhold.
7. Before each use, inspect compressed air system and electrical components for signs of damage, deterioration, weakness or leakage. Repair or replace defective items before using.
8. Check all fasteners at frequent intervals for proper tightness.

 WARNING	
	Compressor parts may be hot even if the unit is stopped.

9. Keep fingers away from a running compressor; fast moving and hot parts will cause injury and/or burns.
10. If the equipment should start to abnormally vibrate, STOP the engine/motor and check immediately for the cause. Vibration is generally a warning of trouble.
11. To reduce fire hazard, keep engine/motor exterior free of oil, solvent, or excessive grease. Never remove or attempt to adjust safety valve. Keep safety valve free from paint and other accumulations.
12. Never attempt to repair or modify a tank! Welding, drilling or any other modification will weaken the tank resulting in damage from rupture or explosion. Always replace worn or damaged tanks. Drain liquid from tank daily.
13. Tanks rust from moisture build-up, which weakens the tank. Make sure to drain tank daily and inspect periodically for unsafe conditions such as rust formation and corrosion.
14. Fast moving air will stir up dust and debris which may be harmful. Release air slowly when draining moisture or depressurizing the compressor system.

SPRAYING PRECAUTIONS

15. Do not smoke when spraying paint, insecticides, or other flammable substances.
16. Use a face mask/respirator when spraying and spray in a well ventilated area to prevent health and fire hazards.
17. Do not direct paint or other sprayed material at the compressor. Locate compressor as far away from the spraying area as possible to minimize overspray accumulation on the compressor.
18. When spraying or cleaning with solvents or toxic chemicals, follow the instructions provided by the chemical manufacturer.

 WARNING	
	Do not spray flammable materials in vicinity of open flame or near ignition sources including the compressor unit.

HOSE PRECAUTIONS

19. Inspect hose before use. Do not exceed working pressure marked on hose. Do not twist, bend knot, or abrade hose. Do not wrap hose around body.
20. Keep away from hot surfaces and chemicals.

Installation

INSTALLATION AND LOCATION

The compressor must be used on a stable level surface. The air compressor must be used in a clean and well-ventilated area. The compressor requires an unobstructed airflow and must be located a minimum of 18 inches from any walls or other obstructions.



Extension Cord Length	Wire Size (A.W.C.)
Up to 25 Feet	14
26 to 50 Feet	12
51 to 100 Feet	10



ASSEMBLY INSTRUCTIONS

Assembly

Read all safety instructions before using air compressor.

 WARNING	
 oil	The compressor is shipped without oil in the crankcase. Add oil as indicated below.

Check Oil Level Daily		
--------------------------	---	---

1. After opening the carton, please remove all parts and check against photograph on carton. If any parts are missing, please call 1-866-850-6662.
2. Place air compressor on a flat, level surface.
3. Pour supplied oil into crankcase until the oil level reaches the red dot in the oil level sight glass. Be careful not to overfill.

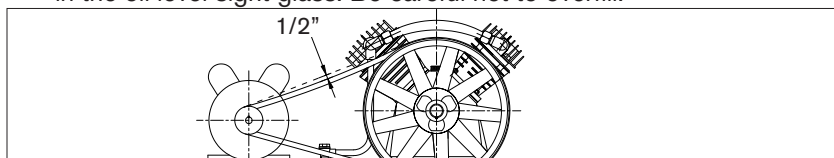

4. Adjust tension of belt to ensure that a maximum of 1/2" / 12mm of slack exists when pressure is placed on belt at centre line.
NOTE: If the belt is installed too tightly, overloading of the motor will occur. This will cause the motor to overheat. If the belt is installed too loosely, it will slip and unstable operation and vibration will occur.
Caution - The rotating direction for the flywheel must follow the arrow shown on the belt guard.
5. Close tank drain valve on the bottom of the air tank by turning the valve clockwise until fully closed.
6. Attach the air coupler to the compressor regulator valve. Use Teflon thread-sealing tape on the threads to make sure you have an airtight connection. Do not over tighten fittings.
7. Attach the supplied air filter to the air intake port on the pump head.
8. Attach air hose and any desired air accessories (which are not included). Use Teflon thread-sealing tape on the threads to make sure you have an airtight connection. Do not over tighten fittings.

NOTICE

Do not operate the compressor without lubricant or with low lubricant level. We are not responsible for damage caused to the compressor due to operation without proper lubrication.



Product Features

1. Automatic ON/OFF Pressure Switch

The compressor is equipped with an automatic on/off pressure switch. The compressor will only run when the switch is in the "I"(ON) position. Once the tank has reached the desired preset pressure (see Operation Instructions), the pump will automatically shut off. While the switch is in the "I"(ON) position, the pump will automatically turn back on once the pressure in the tank drops below the minimum preset pressure. Do not leave the compressor unattended while the power switch is in the "I"(ON) position.

2. Regulator

The regulator allows you to select the amount of air pressure that is output through the air hose into tools and accessories. Refer to the air delivery requirements of your tools for the proper pressure settings.

3. Tank Pressure Gauge

The tank pressure gauge provides a reading of the air pressure inside of the compressor tank.

4. Safety Valve

This compressor is equipped with a safety valve switch that will engage when the pressure in the tank exceeds the maximum rated pressure. DO NOT attempt to modify or remove safety valve.

5. Tank Drain Fitting

Water is produced whenever air is compressed. It is critical to drain water from the air tank on this compressor frequently. If unit is used only occasionally, tank should be drained after each use and prior to the next use. To drain the tank, slowly open the tank drain fitting by turning clockwise. Once all water has drained out, close the fitting securely. **NOTE:** tank will not pressurize while fitting is open.

6. Safety Guard

The belt drive mechanism is protected by a metal guard. Do not attempt to modify or remove this safety guard.



Operating Instructions

Initial Start Up

1. Disconnect tools and/or accessories from the air hose.
2. Open the tank drain valve to allow air to escape preventing air pressure buildup in the air tank.
3. Check to see that the belt is installed properly with the correct tension.
4. Plug power supply cord into proper power source receptacle. (See Grounding Instructions)
5. Run the compressor for a minimum of twenty minutes in this no-load position to lubricate the bearings and piston.
6. Turn off compressor, drain liquid from tanks and close drain valve.
7. The compressor is now ready for use.

Start Up

1. Slowly open tank drain by turning clockwise. Allow any water in tank to drain out. Close fitting securely.
2. Before starting the compressor, check for broken components and accessories, and check for damage to the hose.
3. Make sure the power switch is turned "O"(OFF) position.
4. Attach desired tool to the end of the air hose.
5. Turn the switch on the "I"(ON) position.
6. Adjust regulator knob to desired pressure level once the pump has shut off and the compressor has stopped running.

Storage

1. Disconnect tools and/or accessories from the air hose.
2. Locate drain valve on bottom side of tank.
3. Open drain valve to release remaining pressurized air and moisture from the air tank. Moisture buildup in the tank is normal with air compressors, so a small amount of water may come out while draining the tank. Draining the tank is vital for longevity and safety of your air compressor.
4. Close valve and store the compressor in a cool, dry place.

Shut Down

1. Turn the ON/OFF lever to the OFF position.
2. Rotate the pressure regulator knob counterclockwise until it is fully closed. Check regulated pressure gauge to ensure that it reads 0 PSI.
3. Remove air hose and other connected accessories.
4. Slowly open air tank drain valve to release remaining pressurized air, and tilt unit to fully drain accumulated liquid from air tanks. Moisture build-up in the tank is normal with air compressor, so a small amount of water may come out while draining the tank. Draining the tank is vital for the longevity and safety of your air compressor.
5. Close drain valve.
6. Allow compressor to cool down.
7. Clean and store compressor.

Maintenance

When performing any maintenance or service

- The air compressor must be turned off.
- Drain tanks.
- Allow compressor to cool down.

Daily

- Check oil level.
- Drain accumulated liquid from tanks.
- Check for oil leaks.
- Check for unusual noise and/or vibrations
- Check that all fasteners are secure.

Weekly

- Check safety relief valve.
- Inspect and clean air filter.
- Clean breather holes on oil check dipstick.

Monthly

- Check for air leaks.
- Apply a solution of soapy water around joints.
- Look for air bubbles around joints when compressor reaches the pressure cut-out limit and pump turns off.
- Adjust belt tension and replace if worn or damaged.

Six Months or 250 Operating Hours

- Change compressor oil.
- Use only SAE 20 or SAE 30 weight non-detergent oil.
- Replace oil more frequently when used in dusty operating environments.

Oil Change

1. Place oil drain pan below oil drain plug.
2. Remove dipstick to allow air to enter crankcase.
3. Remove oil drain plug.
4. Allow oil to drain completely.
5. Clean and replace oil drain plug.
6. Refill crankcase with SAE 20 or SAE 30 weight non-detergent oil to red dot on oil level sight glass. Be careful not to overfill.



TROUBLESHOOTING

Troubleshooting Chart

Trouble	Possible Cause	Corrective Action
No start condition	Gas engine not running	Check operation of gas engine
Low pressure	Air leak in safety valve	Check valve manually by pulling upward on rings. If condition persists, replace valve.
	Loose tube or fittings	Tighten fittings
	Restricted air filter	Clean or replace
	Belt loose	Adjust belt tension
	Defective check valve	Replace check valve
Safety valve releasing	Defective pressure switch or improper adjustment	Check for proper adjustment and if problem persists, replace pressure switch
Oil discharge in air	Improper oil viscosity	Replace oil with 20-30 weight non-detergent oil
	Too much oil in crankcase	Drain crankcase and fill to proper level
	Restricted air filter	Clean or replace filter
	Worn piston rings	Replace piston rings
Excessive belt wear	Belt too loose	Adjust for proper tension
	Belt too tight	Adjust for proper tension
	Motor pulley out of alignment	Align motor pulley by adjusting the position of the electric motor

During the break-in period, nuts and bolts have a tendency to loosen. After two weeks, tighten all nuts and bolts including head bolts. Check every month to make sure all nuts and bolts stay tight.

Parts Diagram

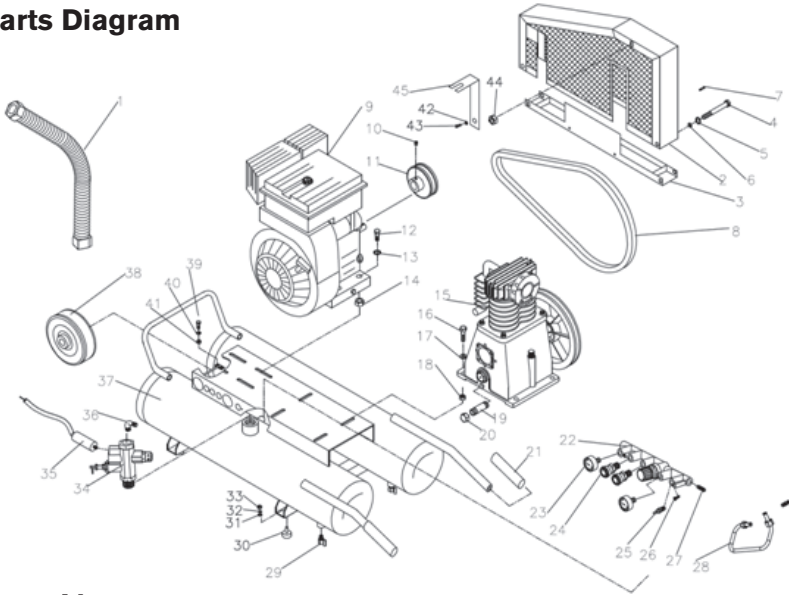

Parts List

No.	Description	Qty	Part #	No.	Description	Qty	Part #
1	Exhaust Pipe Assembly	1	500712250	24	Quick Disconnect	2	80MS1/4MOscr
2	Safety Guard	1	2009618A	25	Safety valve	1	301014N6A
3	Safety Guard	1	2009605	26	Screw,Cross recess head	2	6021515
4	Bolt	2	6005890	27	nipple	2	20331438A
5	Spring Washer	2	60018	28	Pipe	1	500738290
6	Washer	2	60028	29	Drain Cock	2	300214C
7	M5x0.8x8 Screw	3	603458	30	Foot Rubber Pad	4	2005621
8	V-Belt	1	4004A53	31	8 Flat Washer	4	60248
9	Engine	1	02G70	32	Spring Washer	4	60018
10	In-six Angle Bolt	1	6011520	33	Bolt	4	6005830
11	Motor Pulley	1	4002451905A1	34	Pilot Unloader Valve	1	30091212
12	Bolt	4	6005840	35	Gas Pedal	1	304318-1
13	Spring Washer	4	60018	36	Exhaust Elbow	1	50051234C
14	Six Angle Nut	4	60068	37	Air Tank	1	20T028D411
15	Pump	1	01UH30-2	38	Tank Wheel	1	200210C
16	Bolt	4	6005830	39	Screw,Cross recess head	2	6021535
17	Spring Washer	4	60018	40	Spring Washer	2	60015
18	Six Angle Nut	4	60068	41	Six Angle Nut	2	60065
19	Discharge tubing	1	5318UH30	42	Washer	2	60026
20	Six Angle Nut	1	5318UH301	43	Screw	1	6005625
21	Grip, Handle	2	200624120	44	Six Angle Nut	1	60066
22	Manifold	1	300514275	45	link span	1	60263
23	Pressure Gauge	2	30032014LC				

Pump

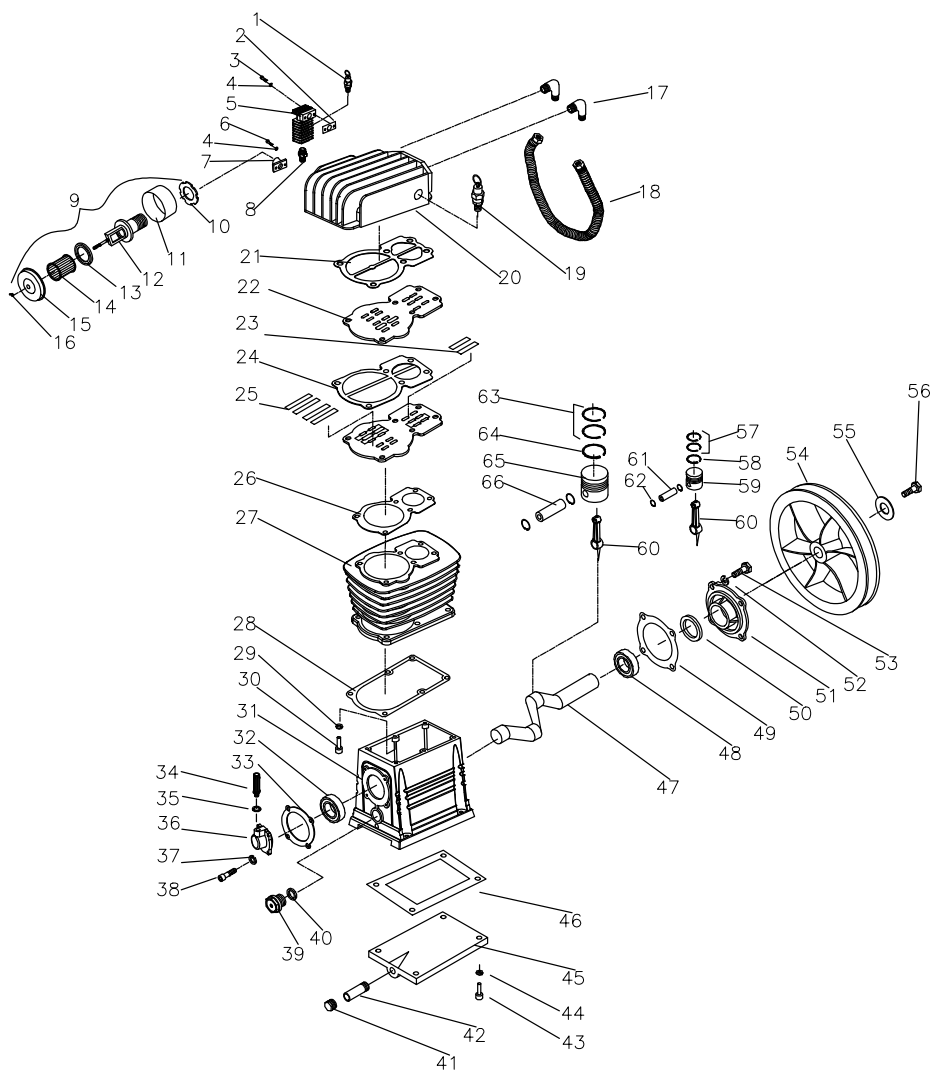

Parts List

No.	Description	Qty
1	Safety Valve	1
2	Cooler Washer	1
3	In-Six Angle Bolt	2
4	Spring Washer	4
5	Exhaust Cooler	1
6	In-Six Angle Bolt	2
7	Flange	1
8	Nipple	1
9	Air Filter Assy	1
10	Check Washer, Air Filter	1
11	Rear Cover, Air Filter	1
12	Connect Seat, Air Filter	1
13	Washer, Air Filter	1
14	Element, Air Filter	1
15	Front Cover, Air Filter	1
16	Nut	1
17	Cooler Elbow	2
18	Intercooler copper pipe	1
19	Safety Valve	1
20	Cylinder Head	1
21	Gasket, Cylinder Head	1
22	Valve Seat	2
23	Valve Plate	2
24	Al. Gasket	1
25	Valve Plate	4
26	Gasket, Cylinder	1
27	Cylinder	1
28	Gasket, Cylinder	1
29	Spring Washer	6
30	In-Six Angle Bolt	6
31	Crankcase	1
32	Bearing	1
33	Gasket, Bearing Cover	1
34	Breather	1
35	Washer, Breather	1
36	Bearing Cover	1
37	Spring Washer	4
38	In-Six Angle Bolt	4

No.	Description	Qty
39	Oil Leveler	1
40	Washer, Oil Leveler	1
41	Oil Drain Plug	1
42	Oil Drain pipe	1
43	In-Six Angle Bolt	4
44	Spring Washer	4
45	Soleplate	1
46	seat gasket	1
47	Crankshaft	1
48	Brearing	1
49	Gasket, Bearing Seat	1
50	Oil Seal	1
51	Bearing Seat	1
52	Spring Washer	6
53	Bolt	6
54	Pulley	1
55	Washer	1
56	Bolt	1
57	Compression Ring	2
58	Oil Ring	1
59	Piston	1
60	Connecting Rod	2
61	Piston Pin	1
62	Circlip for Hole	4
63	Compression Ring	2
64	Oil Ring	1
65	Piston	1
66	Piston Pin	1

**If you need assistance with the
assembly or operation of this
Compressor please call**

1-866-850-6662