



INSTALLATION AND OPERATION MANUAL

EPA CERTIFIED
WOOD BURNING
FIREPLACE INSERT



www.nficertified.org

We suggest that our wood-burning hearth products be installed and serviced by professionals who are certified in the U.S. by the National Fireplace Institute® (NFI) as NFI Woodburning Specialists or who are certified in Canada by

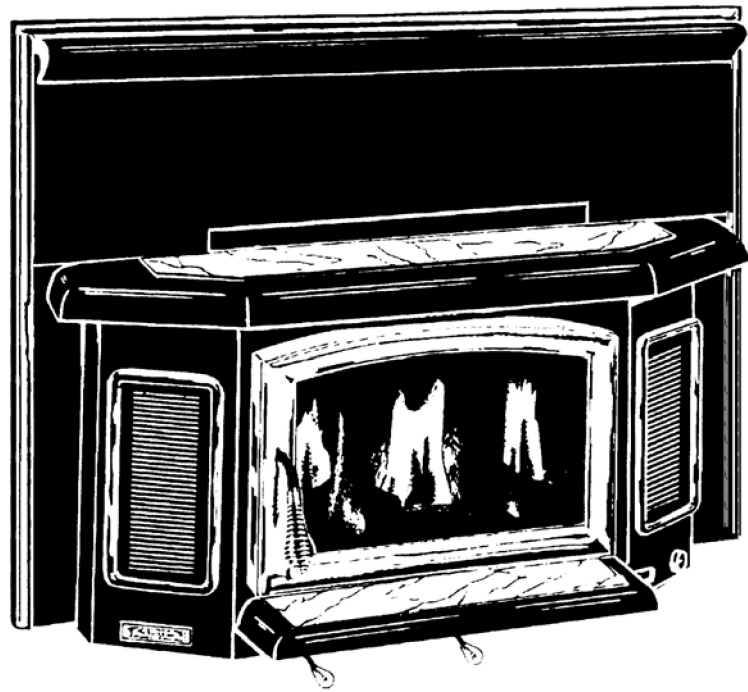

RETAIN THESE
INSTRUCTIONS
FOR FUTURE
REFERENCE

MODEL 2800HT

**THIS APPLIANCE MUST BE INSTALLED BY A QUALIFIED INSTALLER.
READ ENTIRE MANUAL THOROUGHLY BEFORE INSTALLATION.**

Tested &
Listed By



Beaverton
Oregon USA

OMNI-Test Laboratories, Inc.

P/N 775004M, Rev. J, 11/03

REPLACEMENT PARTS LIST – Model 2800HT

Part No.	Description
	<i>Door Parts</i>
G300	Door Assembly, Gold (Handle Included)
86-128	Gasket Kit, 3/4" Door Rope (Includes Adhesive)
27M81	Gasket Kit, Glass Channel
27M67	Clip Set, Glass
G400-7	Glass, Large Arched 11 1/8 X 17" (Glass gasket not included)
10300	Handle Assembly
11529	Hinge, Pin 10 L 18, Original (Requires Welding)
11531	Hinge Pin 1/4-28 UNF (Retrofit - requires drill #3 (.213") & tap
10362	Torque Plate (Latch)
	<i>Electrical Parts</i>
26M22	Power Cord
11573	Motor, fan (propeller included)
16120	Fan, Assembly Left
16110	Fan, Assembly Right
410-25-3	Propeller, Fan
16093	Wire Harness Assembly
528	Rheostat, W/Connectors (Knob Not Included p/n 10050087)
10050087	Rheostat, Knob
410-270	Rocker Switch, On/Off Switch
11565	Disc, Fan, F110°-20F, 60T12
410-265	Terminal, Block Small
410-260	Terminal, Block Large
	<i>Component Parts</i>
16090	Fan Panel - Left Louvered
16091	Fan Panel - Right Louvered
16039	Control Assembly, Start-Up Air
907	Handle, Spring Module
16101	Shield, Low Profile
	<i>Surround And Trim</i>
11817	Air Intake Housing Gold Trim (requires 2)
2046	Corner Key For Trim
2842	Surround Kit 32 X 42" (Standard with Gold Tone Trim)
2047	Trim, Surround (Gold Tone) 32 X 42"
	<i>Firebox Parts</i>
16052	Baffle Plate, Top (3/8" Thick)
16012	Retainer, Back Brick
16010	Retainer, Side Brick
26M21	Secondary Air Tube Set (3 tubes, tabs included)
16056	Tab, Air Tube Retainer
	<i>Miscellaneous/Component Parts</i>
MS2802	Marble Set, Gray (Also requires 1ea. 1053 & 4ea. 1051)

REPLACEMENT PARTS LIST – Model 2800HT

Part No.	Description
MS2805	Marble Set, Green (Also requires 1 each 1053 & 4 each 1051)
1053	Cerawool Pad For Marble (requires 1)
1051	Cerawool Strips, For Marble (requires 4)
775004M	Installation / Operation Manual

For the location of the nearest dealer for replacement parts, contact:

**Lennox Hearth Products
1110 West Taft Avenue
Orange, CA 92865**

COMPONENT DIAGRAMS – Model 2800HT

FIREBRICK (1 1/4" THICK)

Part	Qty	Dimensions
FB-3	2	9 x 4 1/2" w/Hole, Notch
FB30	1	8 1/4 x 1" Regular
FB19	1	9 x 4 1/2" w/Cut-out
FB22	1	9 x 3 1/4" Regular
FB23	2	5 x 1" Regular
FB-1	6	9 x 4 1/2" Regular
FB-2	8	9 x 4 1/2" Notched

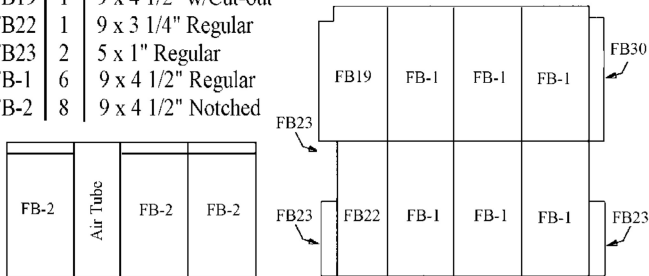

LEFT

BOTTOM

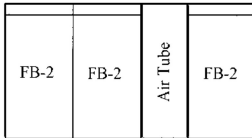

RIGHT

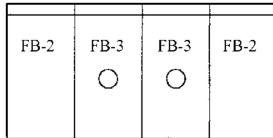

BACK

AIR CONTROLS

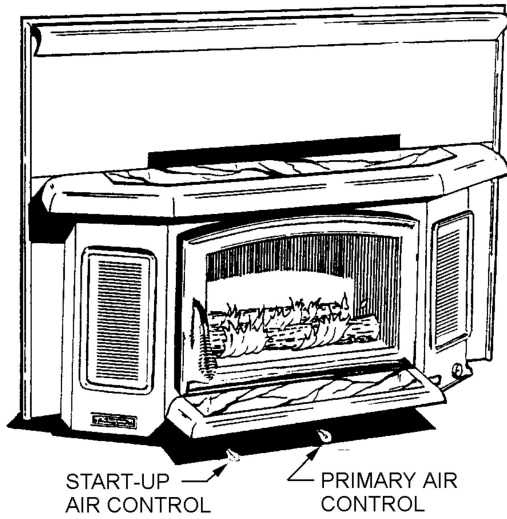

DOOR ASSEMBLY

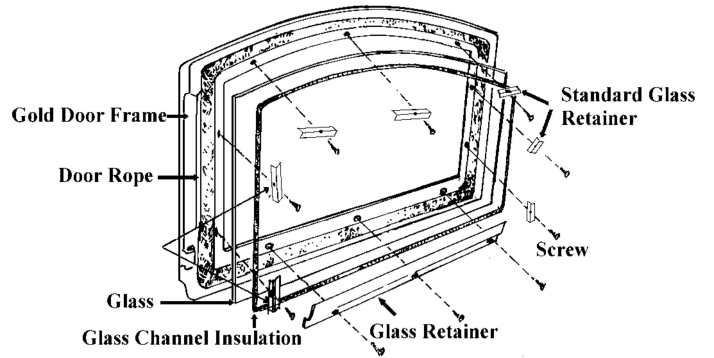

HANDLE ASSEMBLY

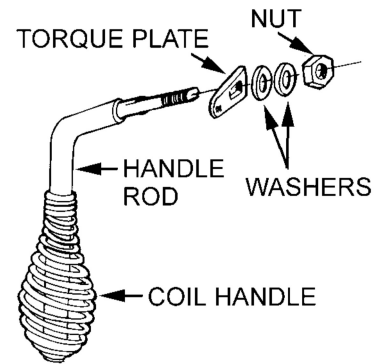

FIREBOX PARTS

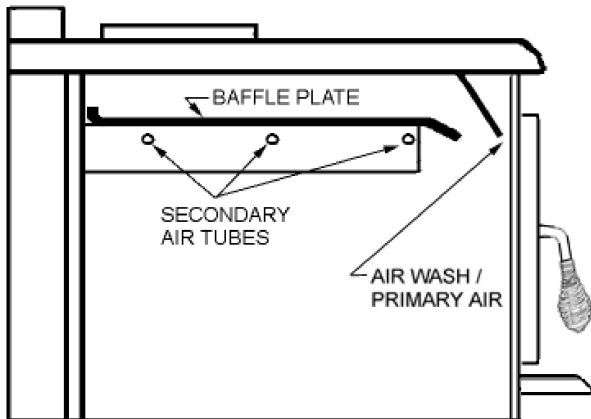

SAFETY/LISTING LABEL

Catalog #	Model	Description (Model)
14M78	OA2800-66	Offset adapter, 6" to 6" diameter
14M74	ZCFK-28	Zero Clearance Fireplace Kit
14M75	MFK-28	Masonry Fireplace Kit
70K99	TSPK-B	Touch-up spray paint kit, black 12 oz Spray Can

OFFSET ADAPTER

Installations requiring offsets can be handled using an offset adapter (it aligns starter pipe with flue).

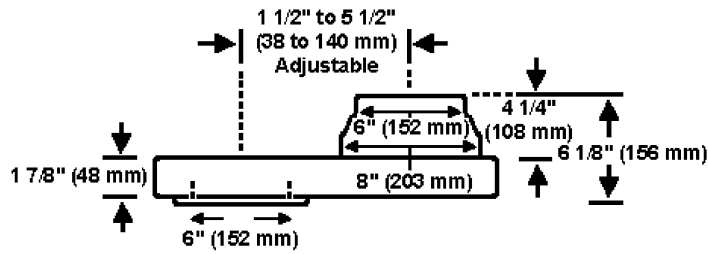

Actual Appearance

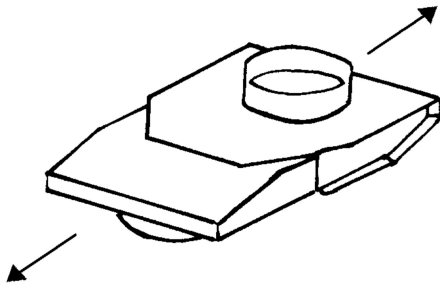

Masonry Fireplace Kit

This header insulation kit is required when installing the insert into a masonry fireplace with an opening height of 21" to 24". Opening heights higher than 24" do not require this kit.

Zero Clearance Kit

When installing the 2800HT into a "high dome" or "low profile" type factory built fireplace (ZC), this kit is required. The kit consists of insulation and components to deflect and dissipate heat.