

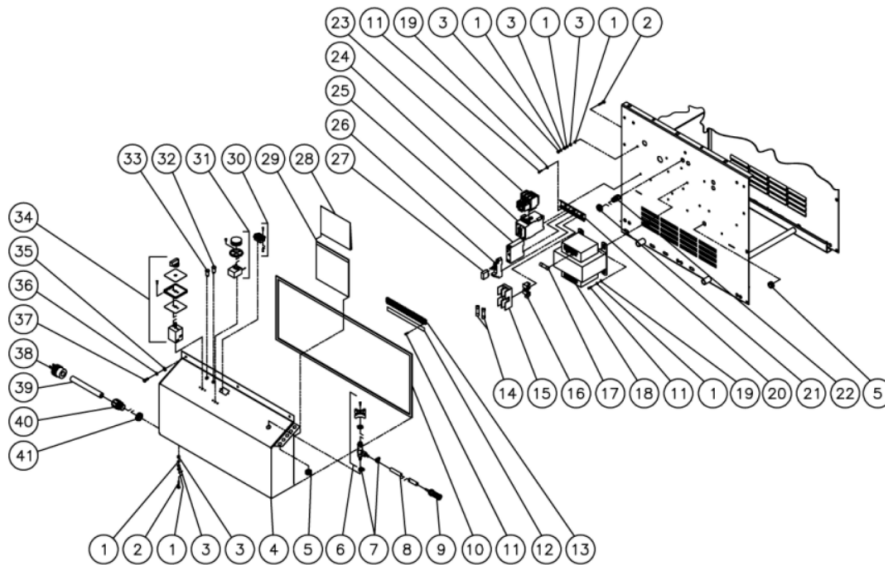

HHD-3004-0E9G / HHD-3004-0E9G (sn:0-99999999)

## ELECTRIC BOX



Id	Item #	Description	Quantity
1	28-1009	WASHER	9
2	27-8807	BOLT	2
3	30-6001	NUT	5
4	20-0526A18	ELECTRIC BOX	1

<b>Id</b>	<b>Item #</b>	<b>Description</b>	<b>Quantity</b>
5	33-0001	GROMMET	9
6	22-0226	DETERGENT VALVE	1
7	42-0004	HOSE CLAMP	2
8	15-0021	HOSE *(SIX FEET REQUIRED)	1
9	19-0056	DETERGENT STRAINER W/CHECK	1
10	26-0240	GASKET	1
11	27-8835	SCREW	8
12	N/A Sep.	DECAL- TERMINAL STRIP (SEE 34-9009)	1
13	32-0463	TERMINAL STRIP	1
14	32-0676	FUSE- 4 AMP (HHD-2004/3004/3005-0E4G)	2
14	32-0688	FUSE- 2 AMP (HHD-3004/3005-0E5G)	2
15	32-0681	FUSE HOLDER	1
16	32-0682	DIN RAIL MOUNT ADAPTER	2
17	32-0675	FUSE- 10 AMP	1
18	32-0678	TRANSFORMER (HHD-2004/3004/3005-0E4G)	1
18	32-0677	TRANSFORMER (HHD-3004/3005-0E5G)	1
19	28-0001	WASHER	6
20	32-0316	DIN RAIL *(ONE FOOT REQUIRED)	1
21	32-0587	LOCKNUT	2
22	32-0586	STRAIN RELIEF	2
23	32-0481	OVERLOAD RELAY (HHD-2004-0E4G/3004-0E5G)	1
23	32-0482	OVERLOAD RELAY (HHD-3004/3005-0E4G/3005-0E5G)	1
24	32-0477	CONTACTOR	1
25	32-0509	TIMER	1
26	32-0476	SOCKET	1
27	32-0475	RELAY	1
28	37-0604	WIRE DIAGRAM/SCHEMATIC	1
29	41-0184	ENVELOPE	1
30	32-0668	HOUR METER	1
31	22-0310	ADJUSTABLE THERMOSTAT	1
32	32-0670	INDICATOR LIGHT- RED	1
33	32-0244	INDICATOR LIGHT- GREEN	1
34	32-0464	CAM SWITCH	1
35	28-0002	WASHER	3
36	29-0006	LOCKWASHER	3
37	27-0015	BOLT	3
38	32-0117	PLUG (HHD-2004/3004/3005-0E4G)	1
38	32-0695	PLUG (HHD-3004/3005-0E5G)	1
39	32-0023	CORD *(FORTY FEET REQUIRED)	1

<b>Id</b>	<b>Item #</b>	<b>Description</b>	<b>Quantity</b>
40	9-0046	STRAIN RELIEF	1
41	32-0292	LOCKNUT	1
	34-9009	SAFETY DECAL KIT (INCLUDES 12)	
		*MUST ORDER IN ONE FOOT LENGTHS	



HHD-3004-0E9G / HHD-3004-0E9G (sn:0-99999999)

## HEAT EXCHANGER

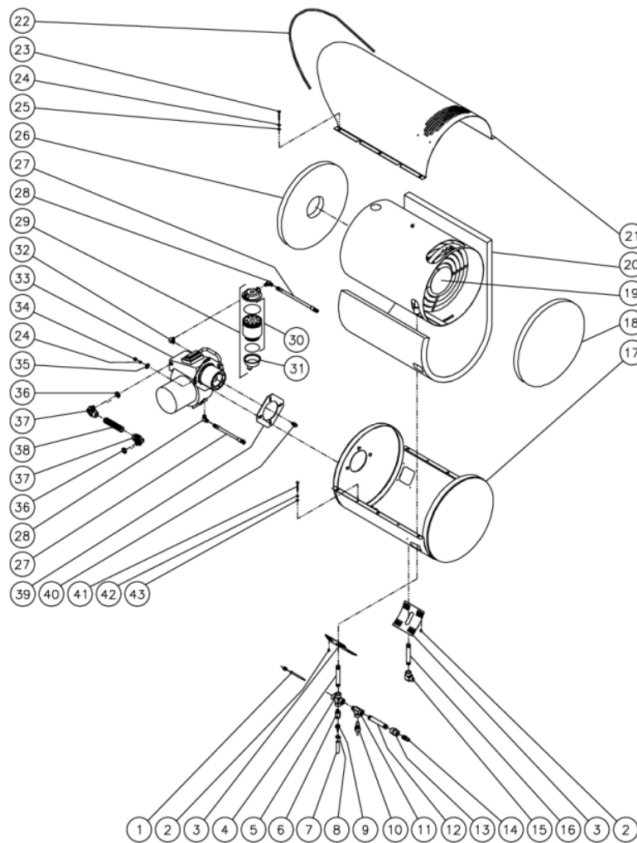

Id	Item #	Description	Quantity
1	22-0310	ADJUSTABLE THERMOSTAT	1
2	27-3062	SCREW	8
3	20-0537A18	PATCH PLATE	2
4	24-0244	PIPE NIPPLE	1

Id	Item #	Description	Quantity
5	24-0241	CROSS	1
6	22-0306	SAFETY RELIEF VALVE ASSY (HHD-1002/1003/2004)	1
6	22-0307	SAFETY RELIEF VALVE ASSY (HHD-3004/3005)	1
7	15-0020	HOSE *(TWO FEET REQUIRED)	1
8	42-0004	CLAMP	1
9	23-0069	HOSE BARB	1
10	32-0666	HI-LIMIT	1
11	24-0242	STREET TEE	1
12	24-0246	PIPE NIPPLE	1
13	24-0243	ADAPTER	1
14	17-0005	QUICK CONNECT PLUG	1
15	24-0240	ELBOW	1
16	24-0245	PIPE NIPPLE	1
17	21-0145	BOTTOM WRAP ASSEMBLY	1
18	33-0346	INSULATION DOME	1
19	66-0014	COIL ASSEMBLY	1
20	850-0279	INSULATION BLANKET (REPLACEMENT ONLY)	1
21	21-0129	TOP WRAP	1
22	33-0020	TRIMLOCK *(THREE FEET REQUIRED)	1
23	27-0121	BOLT	6
24	29-0008	LOCK WASHER	9
25	28-0030	WASHER	6
26	33-0345	INSULATION DOME	1
27	15-0147	FUEL NOZZLE	2
28	23-0237	ELBOW	2
29	19-0070	FUEL/WATER SEPERATOR	1
30	19-0053	FUEL WATER SEPARATOR STRAINER	1
31	19-0071	FUEL WATER SEPARATOR BOWL	1
32	23-0130	ELBOW	1
33	4-0020	BURNER (HHD-1002-0E1G)	1
33	4-0019	BURNER (HHD-1003-0E1G)	1
33	4-0018	BURNER (HHD-2004/3004-0E2G/3G) (BEFORE SERIAL #15008463)	1
33	4-0017	BURNER (HHD-2004-0E4G, 3004/3005-0E4G/5G) (BEFORE SERIAL #15008540)	1
34	30-0006	NUT	4
35	28-0023	WASHER	3
36	32-0108	CONDUIT W/ELBOW	2
37	32-0254	ELBOW	2
38	32-0253	CONDUIT *(TWO FEET REQUIRED)	1

<b>Id</b>	<b>Item #</b>	<b>Description</b>	<b>Quantity</b>
39	44-0108	GASKET W/BURNER	1
40	18-0357	FUEL NOZZLE- 1.00 (HHD-1002)	1
40	18-0356	FUEL NOZZLE- 1.50 (HHD-1003)	1
40	18-0355	FUEL NOZZLE- 1.75 (HHD-3004)	1
40	18-0090	FUEL NOZZLE- 2.25 (HHD-2004)	1
40	18-0093	FUEL NOZZLE- 2.50 (HHD-3005)	1
41	27-0019	BOLT	4
42	29-0006	LOCKWASHER	4
43	28-0002	WASHER	4

\*MUST ORDER IN ONE FOOT LENGTHS



HHD-3004-0E9G / HHD-3004-0E9G (sn:0-99999999)

## BURNER ASSEMBLY

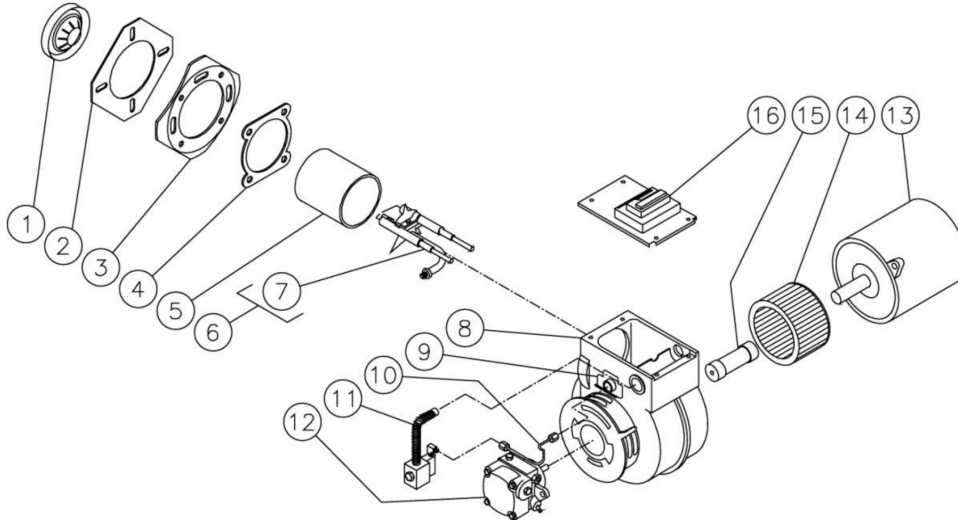

Id	Item #	Description	Quantity
1	44-0011	BURNER HEAD	1
2	44-0108	MOUNTING GASKET	1
3	44-0109	FLANGE	1
4	26-0138	GASKET	1
5	44-0110	AIR TUBE	1
6	44-0113	NOZZLE LINE ASSEMBLY (INC. 7)	1
7	44-0114	ELECTRODE KIT	1
8	44-0033	BURNER HOUSING	1
9	44-0031	ESCUTCHEON PLATE	1
10	44-0026	FUEL LINE	1
11	44-0038	FUEL SOLENOID	1
12	3-0020	FUEL PUMP	1
13	2-0068	MOTOR (4-0017)	1
13	2-0067	MOTOR (4-0018)	1
14	44-0071	BLOWER WHEEL	1
15	44-0014	COUPLER	1
16	44-0017	IGNITION TRANSFORMER (4-0017)	1
16	44-0015	IGNITION TRANSFORMER (4-0018)	1

<b>Id</b>	<b>Item #</b>	<b>Description</b>	<b>Quantity</b>
	4-0017	COMPLETE BURNER (INCLUDES 1-16)	
	4-0018	COMPLETE BURNER (INCLUDES 1-16)	



HHD-3004-0E9G / HHD-3004-0E9G (sn:0-99999999)

## FUEL PUMP/SOLENOID

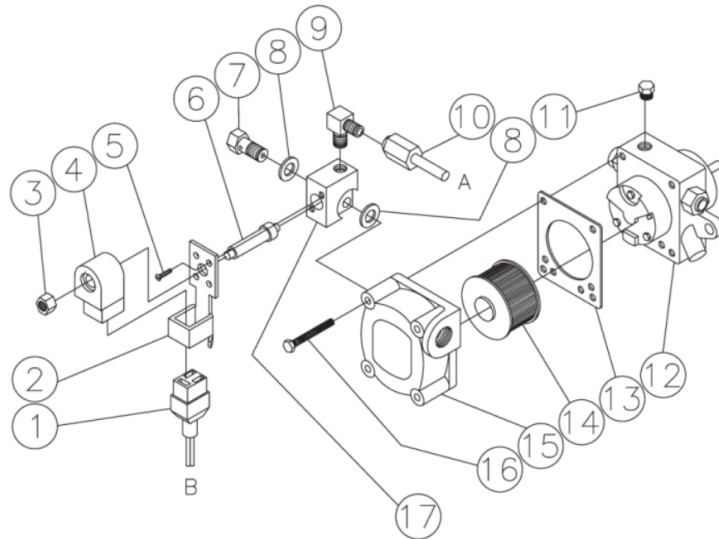

Id	Item #	Description	Quantity
1	46-1017	CORD-DIN CONNECTOR	1
2	N/A Sep.	BASE PLATE (SEE 44-0038)	1
3	46-1016	NUT-SOLENOID PISTON	1
4	44-0002	SOLENOID COIL (120V)	1

<b>Id</b>	<b>Item #</b>	<b>Description</b>	<b>Quantity</b>
5	N/A Sep.	SCREW (SEE 44-0038)	2
6	46-1012	PISTON	1
7	46-1009	BOLT	1
8	26-0150	WASHER	2
9	23-0083	ELBOW	1
10	44-0025	FUEL LINE	1
11	24-0082	PLUG	1
12	N/A Sep.	FUEL PUMP BODY (SEE 3-0020)	1
13	26-0109	COVER GASKET	1
14	19-0034	FUEL PUMP STRAINER	1
15	46-1005	FUEL PUMP COVER	1
16	46-1006	SCREW	4
17	N/A Sep.	SOLENOID BODY (SEE 44-0038)	1
	44-0038	FUEL SOLENOID- 120V (INC. 1-8, 17)	1
	3-0020	FUEL PUMP (INC. 11-16)	1



HHD-3004-0E9G / HHD-3004-0E9G (sn:0-99999999)

## CHASSIS ASSEMBLY

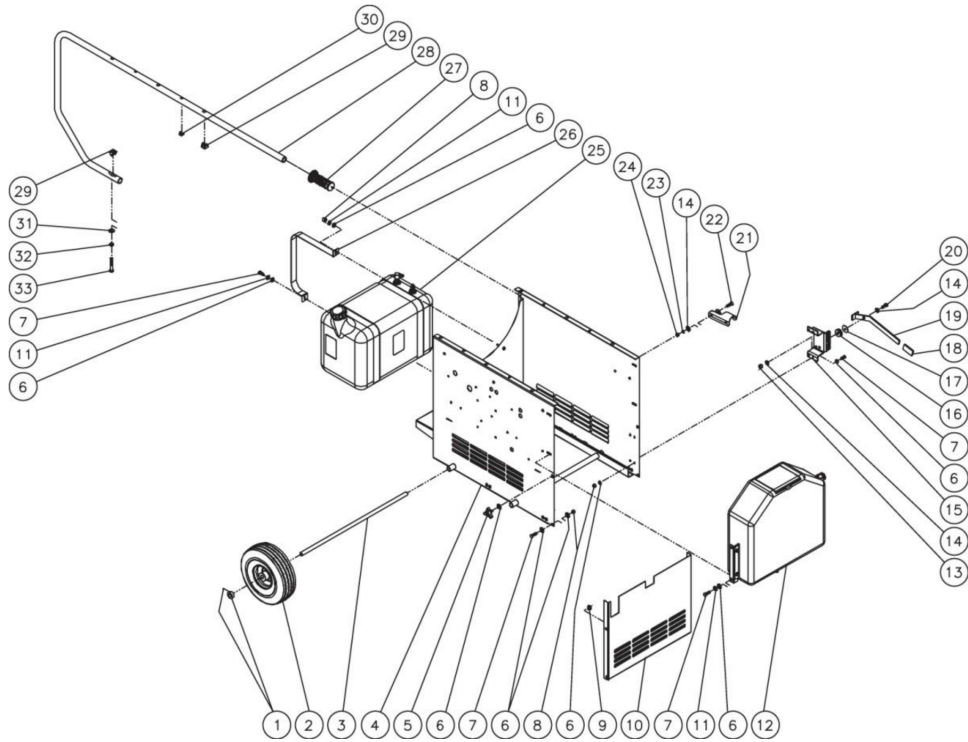

Id	Item #	Description	Quantity
1	33-0351	RETAINING COLLAR W/SET SCREW	4
2	14-0078	WHEEL W/MAG	4
3	5-010504	AXLE	2
4	5-0157A18	CHASSIS ASSEMBLY	1
5	7-0168	KNOB	2
6	28-0002	FLATWASHER	22
7	27-0015	BOLT	12
8	30-0155	HEX NUT	4
9	30-6026	CLIP NUT	2
10	20-0525A18	ACCESS DOOR	1
11	29-0006	LOCKWASHER	8
12	N/A Sep.	FLOAT TANK ASSEMBLY (SEE EXPLODED DRAWING)	1
13	30-0157	NUT	1
14	28-0003	FLATWASHER	4

<b>Id</b>	<b>Item #</b>	<b>Description</b>	<b>Quantity</b>
15	20-0546A18	BRAKE	1
16	28-0057	FLATWASHER	1
17	33-0366	GROMMET	1
18	7-0170	HANDLE GRIP	1
19	20-0552A18	HANDLE BRAKE	1
20	27-0068	BOLT	1
21	20-0545A18	WAND HOLDER	1
22	27-0418	BOLT	2
23	29-0007	LOCKWASHER	2
24	30-0005	NUT	2
25	850-0303	FUEL TANK ASSEMBLY	1
26	20-0598A18	FUEL TANK STRAP	2
27	7-0167	HANDLE GRIP	2
28	7-0166A18	HANDLE	2
29	30-6025	CLIP NUT	8
30	30-6027	CLIP NUT	4
31	28-0023	WASHER	2
32	29-0008	LOCKWASHER	2
33	27-0121	BOLT	2

\*MUST ORDER IN ONE FOOT LENGTHS



HHD-3004-0E9G / HHD-3004-0E9G (sn:0-99999999)

## FLOAT TANK

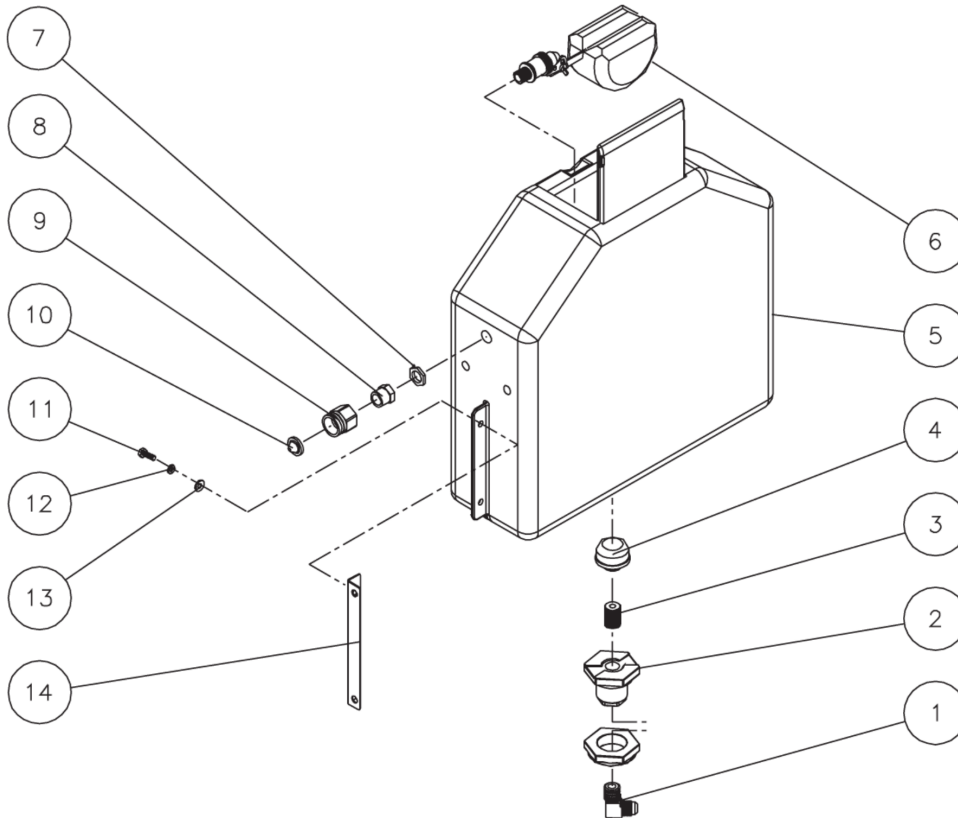

Id	Item #	Description	Quantity
1	23-0389	ELBOW	1
2	55-0886	BULKHEAD	1
3	23-0019	CLOSE NIPPLE (HHD-2004/3005)	1
3	23-0403	CLOSE NIPPLE (HHD-1003)	1
3	23-0402	CLOSE NIPPLE (HHD-1002)	1
3	23-0392	CLOSE NIPPLE (HHD-3004)	1
4	19-0203	WATER TANK STRAINER	1
5	12-0124	FLOAT TANK	1
6	850-0238	FLOAT VALVE ASSEMBLY	1
7	23-0138	LOCKNUT	1
8	23-0016	BUSHING	1
9	23-0001	GARDEN HOSE ADAPTER	1

<b>Id</b>	<b>Item #</b>	<b>Description</b>	<b>Quantity</b>
10	19-0001	INLET STRAINER GASKET	1
11	27-0015	BOLT	4
12	29-0006	LOCKWASHER	4
13	28-0002	FLATWASHER	4
14	20-0599	FLOAT TANK BRACKET	2



HHD-3004-0E9G / HHD-3004-0E9G (sn:0-99999999)

## FUEL TANK ASSEMBLY

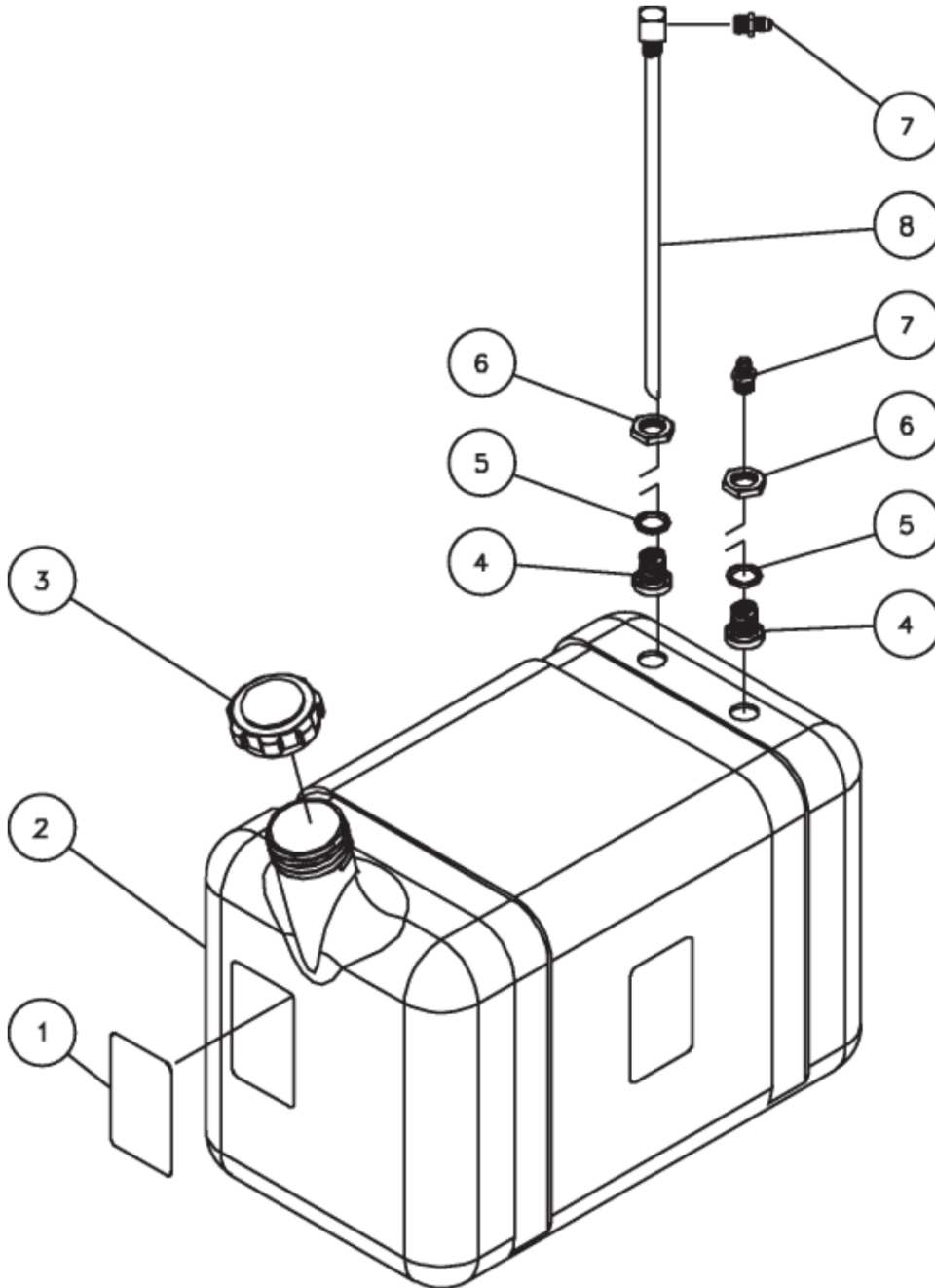

Id	Item #	Description	Quantity
1	34-1034	DECAL- CAUTION: RISK OF FIRE	1
2	12-0126	FUEL TANK	1
3	12-0033	VENTED FUEL CAP	1

<b>Id</b>	<b>Item #</b>	<b>Description</b>	<b>Quantity</b>
4	23-0408	BULKHEAD FITTING	2
5	25-0427	O-RING	2
6	23-0409	NUT	2
7	23-0247	FLARE FITTING	2
8	33-0352	FUEL PICK-UP	1



HHD-3004-0E9G / HHD-3004-0E9G (sn:0-99999999)

## MOTOR/PUMP ASSEMBLY

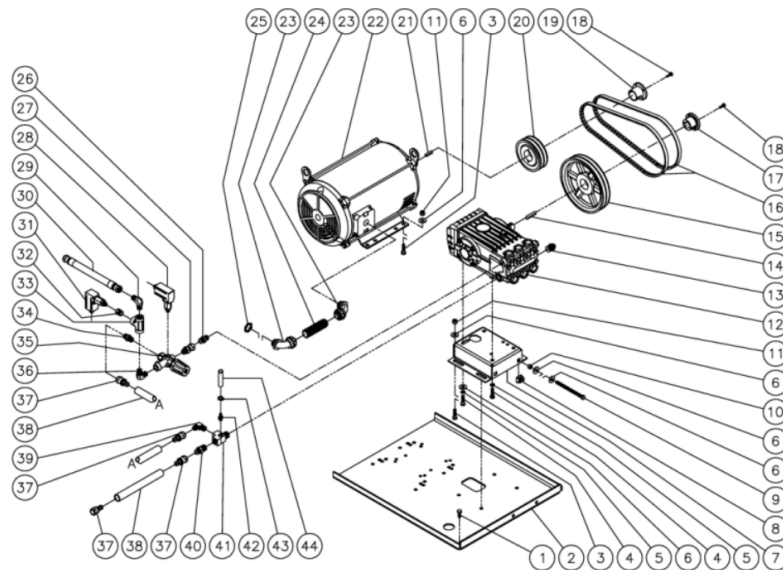

Id	Item #	Description	Quantity
1	27-0066	BOLT	1
2	5-0152A18	BASEPLATE	1
3	27-0118	BOLT	8
4	27-8471	BOLT	4

<b>Id</b>	<b>Item #</b>	<b>Description</b>	<b>Quantity</b>
5	29-0055	LOCKWASHER	4
6	28-0023	FLATWASHER	13
7	5-0153A18	PUMP HAT	1
8	30-6025	CLIP NUT	2
9	27-0133	BOLT	2
10	30-0006	HEX NUT	2
11	30-0159	NUT	8
12	3-0202	PUMP W/KEY	1
13	22-0005	HEAT DUMP VALVE	1
14	43-0048	KEY	1
15	10-0007	SHEAVE	1
16	11-0008	BELT (HHD-2004)	2
16	11-0007	BELT (HHD-3004)	2
16	11-0005	BELT (HHD-3005)	2
17	9-0017	BUSHING	1
18	27-0015	BOLT W/BUSHING	4
19	9-0010	BUSHING (HHD-2004)	1
19	9-0008	BUSHING (HHD-3004/3005)	1
20	10-0036	SHEAVE (HHD-2004)	1
20	10-0065	SHEAVE (HHD-3004)	1
20	10-0104	SHEAVE (HHD-3005)	1
21	43-0078	KEY	1
22	2-0107	MOTOR (HHD-2004-0E2G)	1
22	2-0108	MOTOR (HHD-2004-0E3G/4G)	1
22	2-0109	MOTOR (HHD-3004-0E2G)	1
22	2-0110	MOTOR (HHD-3004-0E3G/4G)	1
22	2-0111	MOTOR (HHD-3004-0E5G)	1
22	2-0112	MOTOR (HHD-3005-0E3G/4G)	1
22	2-0113	MOTOR (HHD-3005-0E5G)	1
22	2-0124	MOTOR (HHD-2004-0E8G)	1
22	2-0125	MOTOR (HHD-3004-0E8G)	1
22	2-0127	MOTOR (HHD-2004-0E9G)	1
22	2-0129	MOTOR (HHD-3004-0E9G)	1
22	2-0131	MOTOR (HHD-3005-0E9G)	1
23	32-0487	CONDUIT ELBOW	2
24	32-0486	CONDUIT *(THREE FEET REQUIRED)	1
25	32-0292	LOCKNUT	1
26	24-0002	NIPPLE	1
27	24-0037	SWIVEL	1

<b>Id</b>	<b>Item #</b>	<b>Description</b>	<b>Quantity</b>
28	22-0171	PRESSURE SWITCH	1
29	24-0092	ELBOW	1
30	15-0221	HIGH PRESSURE HOSE ASSEMBLY	1
31	22-0243	PRESSURE SWITCH	1
32	24-0181	REDUCER	1
33	24-0026	TEE	1
34	23-0370	NIPPLE	1
35	850-0267	UNLOADER ASSEMBLY	1
36	24-0131	ELBOW	1
37	23-0360	HOSE BARB	4
38	15-0200	HOSE *(THREE FEET REQUIRED)	1
39	23-0389	ELBOW	1
40	23-0361	NIPPLE	1
41	23-0388	STREET TEE	1
42	23-0051	HOSE BARB	1
43	42-0004	CLAMP	1
44	15-0021	DETERGENT HOSE *(THREE FEET REQUIRED)	1

\*MUST ORDER IN ONE FOOT LENGTHS.



HHD-3004-0E9G / HHD-3004-0E9G (sn:0-99999999)

## PUMP ASSEMBLY

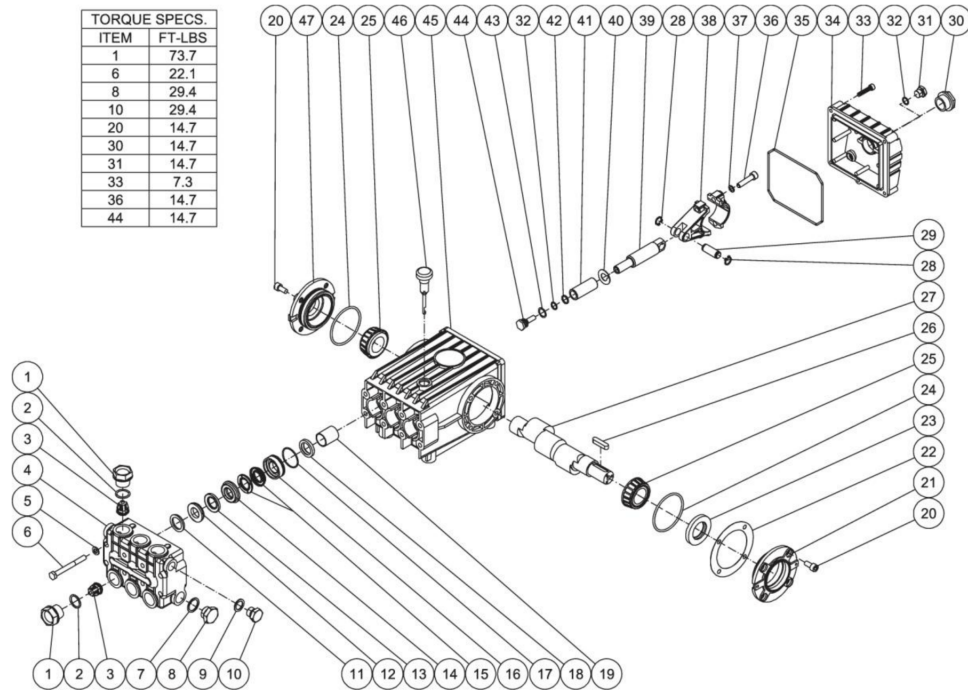

Id	Item #	Description	Quantity
1	46-0889	VALVE CAP	6
2	25-0012	O-RING	6
3	SEE KIT	VALVE (SEE KIT 70-0009)	6
4	46-0890	MANIFOLD	1
5	28-1039	WASHER	8
6	27-8185	BOLT	8
7	28-1038	WASHER	2
8	39-0019	PLUG	2
9	28-1002	WASHER	2
10	39-0018	PLUG	2
11	SEE KIT	HEAD RING (SEE KIT 70-0030 AND 852-0122)	3
12	SEE KIT	V-PACKING SUPPORT (SEE KIT 70-0147 AND 852-0122)	3
13	SEE KIT	O-RING (SEE KIT 70-0147 AND 70-0148 AND 852-0122)	3
14	SEE KIT	HIGH PRESSURE INTERMEDIATE SEAL RETAINER (SEE KIT 70-0148)	3
15	SEE KIT	PRESSURE SEAL (SEE KIT 70-0147 AND 852-0122)	3

<b>Id</b>	<b>Item #</b>	<b>Description</b>	<b>Quantity</b>
16	46-0057	LOW PRESSURE SEAL RETAINER	3
17	SEE KIT	O-RING (SEE KIT 852-0122)	3
18	26-0047	OIL SEAL	3
19	9-0029	BUSHING	3
20	27-8431	BOLT	8
21	46-0296	CRANKCASE COVER	1
22	46-0113	SHIM	1
23	26-0049	OIL SEAL	1
24	25-0013	O-RING	2
25	48-0012	BEARING	2
26	43-0048	KEY	1
27	N/A	CRANKSHAFT	1
28	46-0103	RETAINING RING	6
29	43-0032	CONNECTING ROD PIN	3
30	46-0114	OIL LEVEL INDICATOR	1
31	39-0017	PLUG	1
32	25-0014	O-RING	4
33	27-8404	BOLT	5
34	46-0295	CRANKCASE OPEN COVER	1
35	25-0339	O-RING	1
36	27-8435	BOLT	6
37	29-0154	LOCKWASHER	6
38	46-0051	CONNECTING ROD	3
39	46-0056	PISTON ROD	3
40	46-0146	SLINGER WASHER	3
41	46-0052	PLUNGER	3
42	46-0109	BACK-UP RING	3
43	28-0400	WASHER	3
44	46-0069	NUT / PISTON	3
45	46-0047	CRANKCASE	1
46	46-0144	OIL DIP STICK	1
47	46-0336	CRANKCASE COVER	1
KIT	70-0009	VALVES (INC. 6 EACH 3)	
KIT	70-0030	HEAD RING (INC. 3 EACH 11)	
KIT	70-0147	V-PACKING (INC. 3 EACH 12, 13, 15)	
KIT	70-0148	INTERMEDIATE RETAINER (INC. 3 EACH 13, 14)	
KIT	852-0122	V-PACKING ASSY (INC. 3 EACH 11-13, 15, 17)	



HHD-3004-0E9G / HHD-3004-0E9G (sn:0-99999999)

# UNLOADER

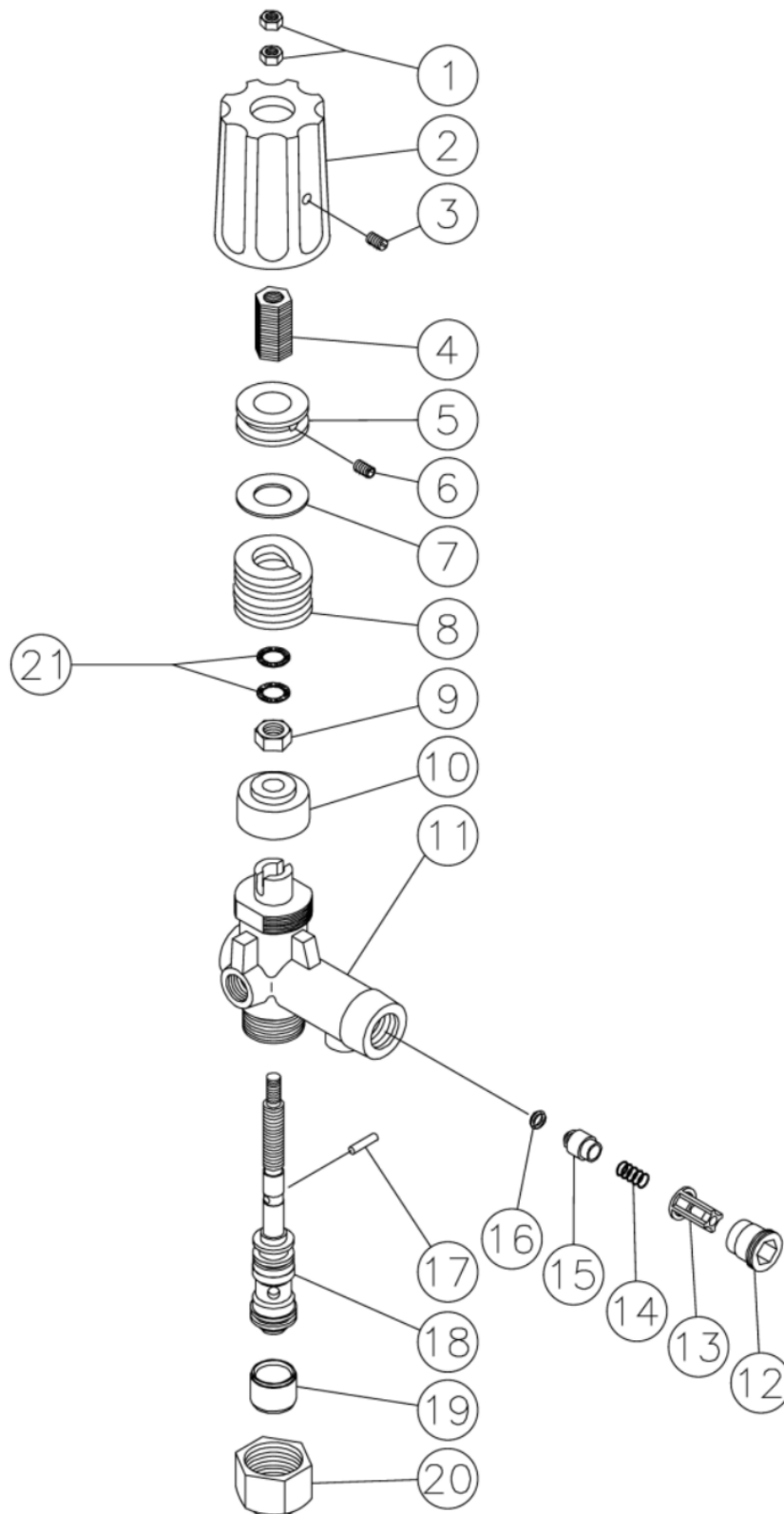

Id	Item #	Description	Quantity
1	8-0362	HEX NUT	2
2	7-0098	COVER	1

<b>Id</b>	<b>Item #</b>	<b>Description</b>	<b>Quantity</b>
3	27-4280	SET SCREW	1
4	8-9002	ADJUSTING INSERT- BRASS	1
5	8-0364	ADJUSTMENT NUT	1
6	8-0365	SET SCREW	1
7	8-0366	GLIDE RING	1
8	49-0104	SPRING	1
9	8-0367	HEX NUT	1
10	8-0368	BUSHING	1
11	8-0369	UNLOADER BODY	1
12	8-0269	RETAINER	1
13	8-0104	VALVE HOUSING	1
14	49-0023	SPRING	1
15	8-0105	VALVE	1
16	25-0036	O-RING	1
17	8-0372	CYLINDER PIN	1
18	70-0243	PISTON REPAIR KIT	1
19	8-0371	SPACER	1
20	8-0157	STOP NUT	1
21	29-0154	WASHER	2
KIT	70-0244	CHECK VALVE REPAIR KIT (INC. 13-16)	
	850-0267	UNLOADER COMPLETE	



HHD-3004-0E9G / HHD-3004-0E9G (sn:0-99999999)

## PRESSURE SWITCH

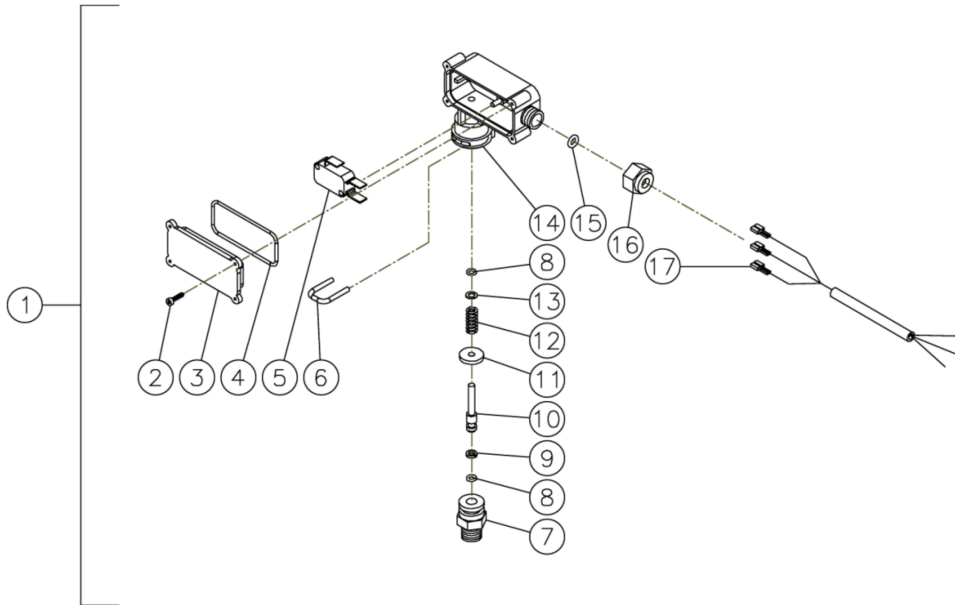

Id	Item #	Description	Quantity
1	22-0171	PRESSURE SWITCH- 15 BAR	1
1	22-0243	PRESSURE SWITCH- 25 BAR	1
2	N/A	SCREW	4
3	N/A	COVER	1
4	N/A Sep.	O-RING (SEE 70-0306)	1
5	N/A	MICRO SWITCH	1
6	N/A	RETAINER CLIP	1
7	N/A	BODY	1
8	N/A Sep.	O-RING (SEE 70-0306)	2
9	N/A Sep.	BACK-UP RING (SEE 70-0306)	1
10	N/A	PISTON	1
11	N/A	WASHER	1
12	49-0144	SPRING- 15 BAR	1
12	49-0145	SPRING- 25 BAR	1
13	N/A	WASHER	1
14	N/A	PLASTIC HOUSING	1

<b>Id</b>	<b>Item #</b>	<b>Description</b>	<b>Quantity</b>
15	N/A Sep.	O-RING (SEE 70-0306)	1
16	N/A	NUT- 15 BAR	1
16	N/A	NUT- 25 BAR	1
17	N/A	WIRE ASSEMBLY	1
KIT	70-0306	O-RING REPAIR KIT (INC. 4, 8-9, 15)	



HHD-3004-0E9G / HHD-3004-0E9G (sn:0-99999999)

## DUAL LANCE ASSEMBLY

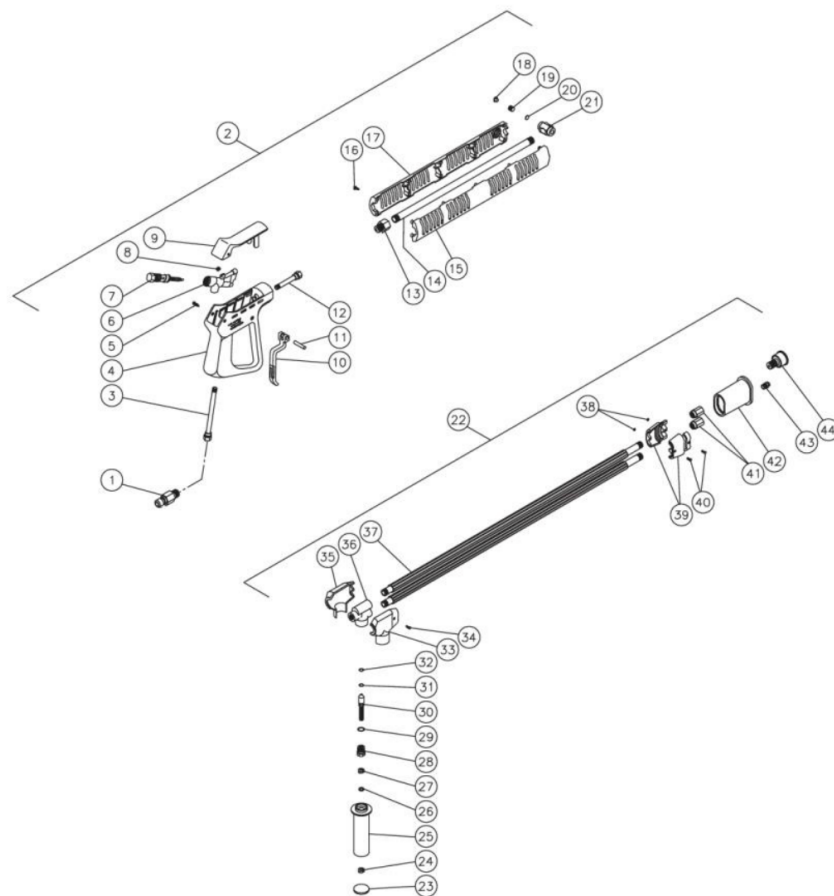

Id	Item #	Description	Quantity
1	17-0005	QUICK CONNECT PLUG	1
2	850-0181	GUN ASSEMBLY (INC. 3-21)	1
3	16-0016	PIPE ASSEMBLY	1
4	16-0008	PLASTIC HOUSING	1

<b>Id</b>	<b>Item #</b>	<b>Description</b>	<b>Quantity</b>
5	27-3230	SCREW	2
6	16-0012	HOUSING	1
7	70-0055	GUN REPAIR KIT	1
8	39-0024	PLUG	1
9	16-0009	COVER	1
10	16-0010	TRIGGER SAFETY LOCK-OFF	1
11	16-0063	TRIGGER PIN	1
12	16-0013	PIPE ASSEMBLY	1
13	16-0283	ADAPTOR	1
14	16-0277	PIPE	1
15	16-0320	GUARD LANCE (RIGHT SIDE)	1
16	27-8382	SCREW	6
17	16-0321	GUARD LANCE (LEFT SIDE)	1
18	39-0076	PLUG	1
19	49-0103	SCREW	1
20	16-0282	SPACER	1
21	N/A Sep.	LANCE HOLDER (SEE 850-0181)	1
22	850-0178	DUAL LANCE ASSEMBLY (INC. 29-44)	1
22	850-0186	DUAL LANCE ASSEMBLY (INC. 29-44)	1
23	16-0312	HANDLE PLUG	1
24	30-3002	HEX NUT	1
25	16-0313	HANDLE	1
26	28-1021	WASHER	1
27	30-3010	HEX NUT	1
28	23-0271	HEX ADAPTOR	1
29	25-0351	O-RING	1
30	16-0314	PISTON	1
31	25-0352	BACK-UP RING	1
32	25-0353	O-RING	1
33	16-0315	UPPER PROTECTOR	1
34	27-8862	SCREW	1
35	16-0316	LOWER PROTECTOR	1
36	23-0272	BODY	1
37	16-0317	LANCE W/PROTECTIVE COVER (850-0178)	2
37	16-0328	LANCE W/PROTECTIVE COVER (850-0186)	2
38	30-3060	HEX NUT	2
39	16-0318	PIPE CLAMP	2
40	27-8861	SCREW	2
41	24-0127	NIPPLE	2

<b>Id</b>	<b>Item #</b>	<b>Description</b>	<b>Quantity</b>
42	16-0319	NOZZLE PROTECTOR	1
43	18-0110	DETERGENT NOZZLE	1
44	17-0028	QUICK CONNECT SOCKET	1
KIT	70-0143	O-RING KIT (INC. 29, 31, 32)	