

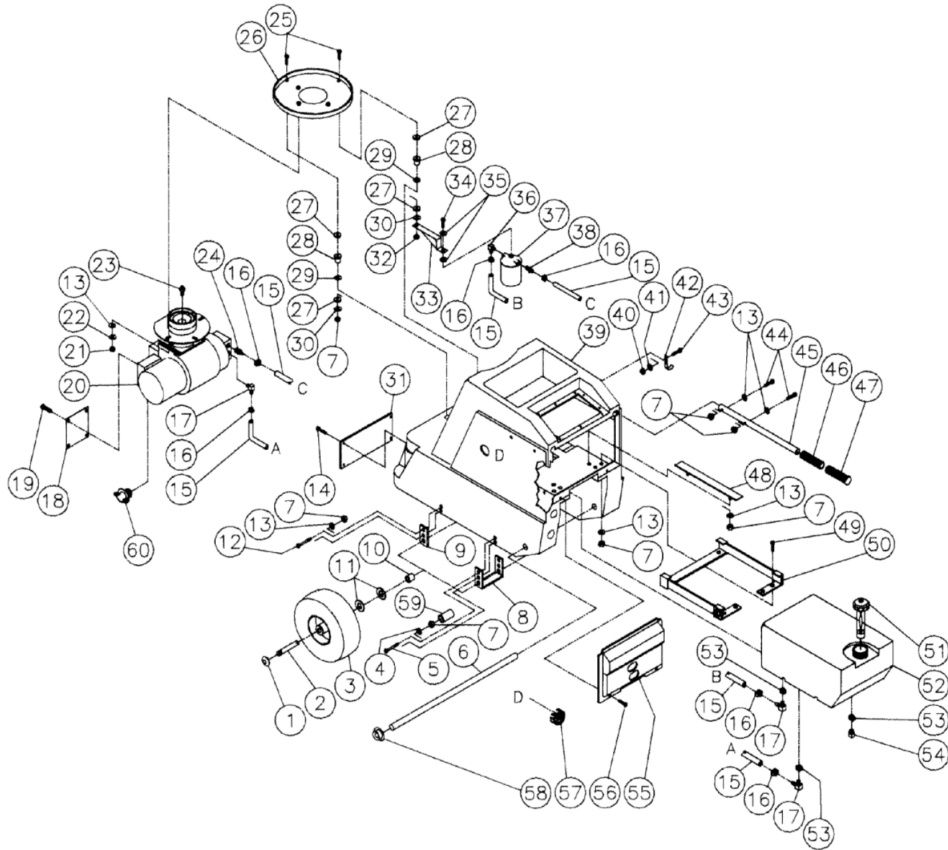

HU-3004-0M11 / HU-3004-0M11 (sn:15611-99999999)

FRAME ASSEMBLY



Id	Item #	Description	Quantity
1	33-0018	HUB CAP	4
2	20-0210	AXLE	2
3	14-0048	WHEEL	4
4	28-0003	WASHER	4
5	27-0540	BOLT	4
6	20-0209	AXLE	2
7	30-0107	NUT	16
8	20-0224	BRACKET	2
9	20-0223	BRACKET	2
10	20-0313	AXLE SPACER	4
11	28-0008	WASHER	8

Id	Item #	Description	Quantity
12	27-0076	BOLT	4
13	28-0022	WASHER	4
14	27-2930	SCREW	4
15	15-0008	HOSE *(FOUR FEET REQUIRED)	1
16	42-0004	HOSE CLAMP	8
17	23-0054	ELBOW	3
18	33-0017	COVER PLATE	1
19	N/A	SCREW	1
20	4-0010	OIL BURNER	1
21	30-0004	HEX NUT	4
22	29-0007	LOCKWASHER	4
23	18-0177	FUEL NOZZLE	1
24	23-0051	HOSE BARB	1
25	27-0075	BOLT	1
26	850-0066	PAN	1
27	28-0650	WASHER	8
28	33-0067	SPACER	4
29	28-0028	WASHER	4
30	28-0057	WASHER	23
31	62-0030	SERVICE PANEL	1
32	30-0157	LOCKNUT	1
33	13-0108	FUEL FILTER BRACKET	1
34	N/A	BOLT	1
35	26-0154	WASHER	2
36	23-0139	HOSE BARB	1
37	19-0012	FUEL OIL FILTER	1
37	19-0010	FUEL OIL FILTER (REPLACEMENT)	1
38	23-0052	HOSE BARB	1
39	62-0006	HOUSING	1
40	30-0155	LOCKNUT	2
41	28-0002	WASHER	2
42	33-0080	J-CLIP	2
43	27-0015	BOLT	2
44	27-0070	BOLT	4
45	7-0060	PUSH HANDLE	2
46	7-0046	FOAM GRIP	1
47	7-0059	HANDLE GRIP	2
48	850-0060	SLIDE RAIL ASSEMBLY	2
49	27-0067	BOLT	4

Id	Item #	Description	Quantity
50	850-0059	SLIDE PLATE ASSEMBLY	1
51	12-0034	FUEL CAP	1
52	12-0032	FUEL TANK	1
53	42-0011	HOSE CLAMP	1
54	24-0009	PLUG	1
55	62-0033	PUMP COVER	1
56	7-0061	KNOB	2
57	39-9001	PLUG	1
58	33-0055	HUB CAP	2
59	15-0031	HOSE *(ONE FOOT REQUIRED)	1
60	32-0076	CONNECTOR	1

*MUST ORDER IN ONE FOOT LENGTHS



HU-3004-0M11 / HU-3004-0M11 (sn:15611-99999999)

BURNER ASSEMBLY

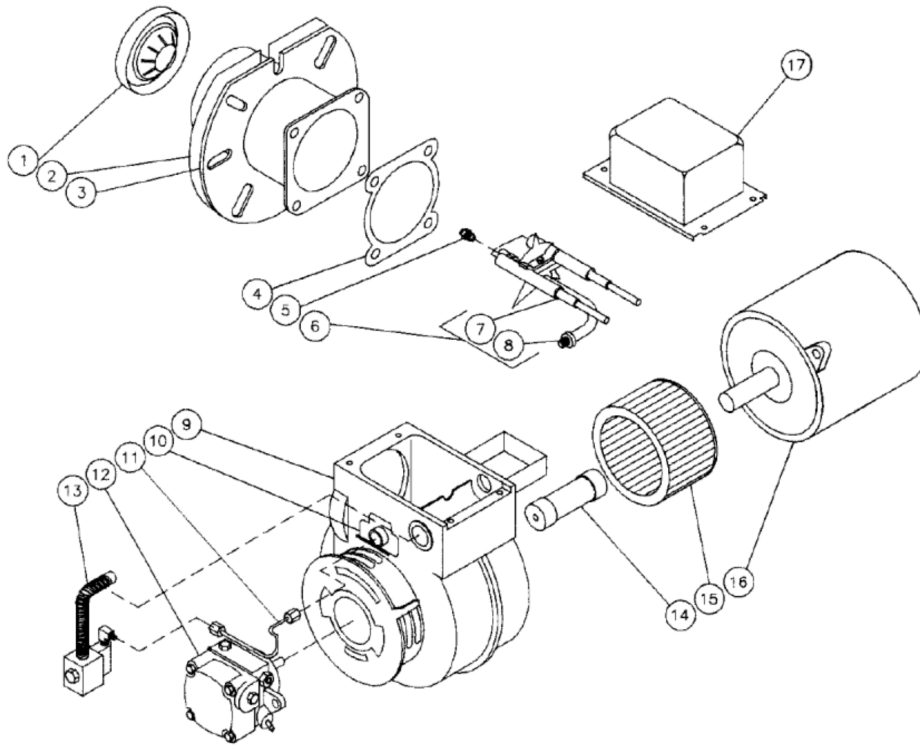

Id	Item #	Description	Quantity
	4-0010	OIL BURNER ASSEMBLY (230V)	1
1	44-0010	HEAD	1
2	26-0062	MOUNTING GASKET	1
3	38-0030	FLANGE	1
4	26-0138	GASKET	1
5	18-0177	OIL NOZZLE	1
6	44-0043	NOZZLE LINE ASSEMBLY (INC. 7, 8)	1
7	70-0076	ELECTRODE KIT	1
8	70-0075	BULKHEAD FITTING	1
9	44-0033	BURNER HOUSING	1
10	44-0031	ESCUTCHEON PLATE	1
11	44-0026	FUEL LINE	1
12	3-0020	FUEL PUMP	1

Id	Item #	Description	Quantity
13	44-0037	FUEL SOLENOID (230V)	1
14	44-0014	COUPLER	1
15	44-0071	BLOWER WHEEL	1
16	2-0067	MOTOR (230V)	1
17	44-0015	IGNITION TRANSFORMER (230V)	1



HU-3004-0M11 / HU-3004-0M11 (sn:15611-99999999)

FUEL PUMP & FUEL SOLENOID

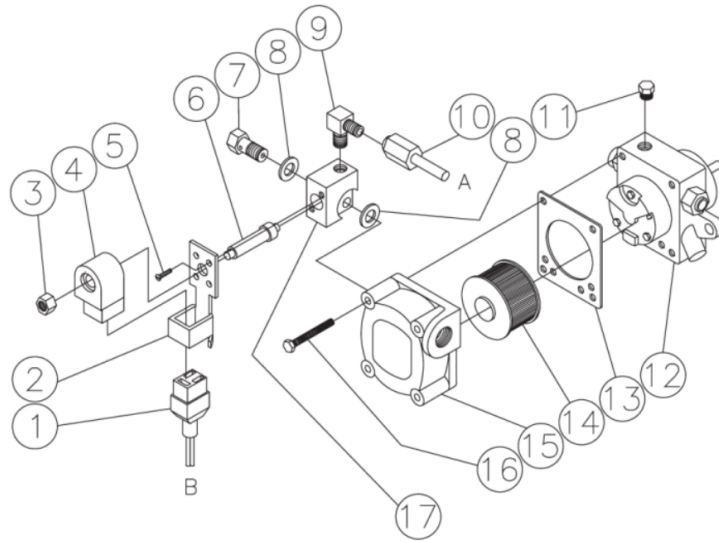

Id	Item #	Description	Quantity
1	46-1017	CORD-DIN CONNECTOR	1
2	N/A Sep.	BASE PLATE (SEE 44-0038)	1
3	46-1016	NUT-SOLENOID PISTON	1
4	44-0002	SOLENOID COIL (120V)	1

Id	Item #	Description	Quantity
5	N/A Sep.	SCREW (SEE 44-0038)	2
6	46-1012	PISTON	1
7	46-1009	BOLT	1
8	26-0150	WASHER	2
9	23-0083	ELBOW	1
10	44-0025	FUEL LINE	1
11	24-0082	PLUG	1
12	N/A Sep.	FUEL PUMP BODY (SEE 3-0020)	1
13	26-0109	COVER GASKET	1
14	19-0034	FUEL PUMP STRAINER	1
15	46-1005	FUEL PUMP COVER	1
16	46-1006	SCREW	4
17	N/A Sep.	SOLENOID BODY (SEE 44-0038)	1
	44-0038	FUEL SOLENOID- 120V (INC. 1-8, 17)	1
	3-0020	FUEL PUMP (INC. 11-16)	1



HU-3004-0M11 / HU-3004-0M11 (sn:15611-99999999)

BOILER ASSEMBLY

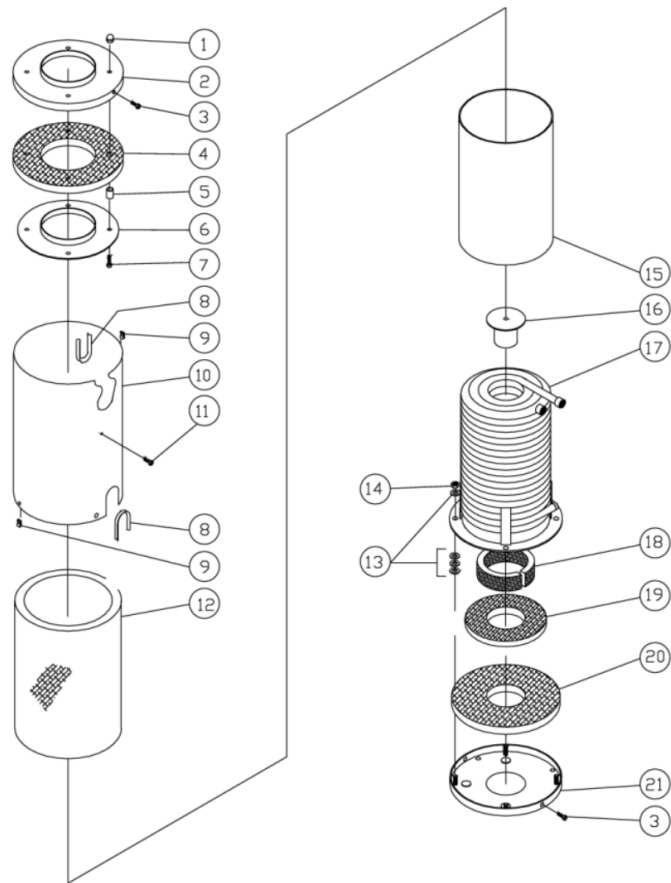

Id	Item #	Description	Quantity
1	30-5204	NUT	4
2	20-0234A01	DOME	1
3	27-2930	SCREW	7
4	33-0124	INSULATION DONUT	1

Id	Item #	Description	Quantity
5	21-0082	SPACER	4
6	20-0282	DOME INSULATION RETAINER	1
7	27-0068	BOLT	4
8	33-0020	EDGING *(TWO FEET REQUIRED)	1
9	30-2104	NUT / U-CLIP	7
10	850-0091	OUTER WRAP ASSEMBLY (S.S.)	1
11	27-3262	SCREW (NOT USED ON HB-UNITS)	2
12	850-0065	INSULATION BLANKET	1
13	28-0023	WASHER	12
14	30-0109	NUT	3
15	850-0089	SHELL	1
16	20-0226	TARGET ASSEMBLY	1
17	850-0106	COIL ASSEMBLY	1
18	850-0102	INSULATION STRIP	1
19	33-0123	INSULATION DONUT	1
20	33-0121	INSULATION DONUT	1
21	850-0066	PAN	1

*MUST ORDER IN ONE FOOT LENGTHS



HU-3004-0M11 / HU-3004-0M11 (sn:15611-99999999)

MOTOR/PUMP ASSEMBLY

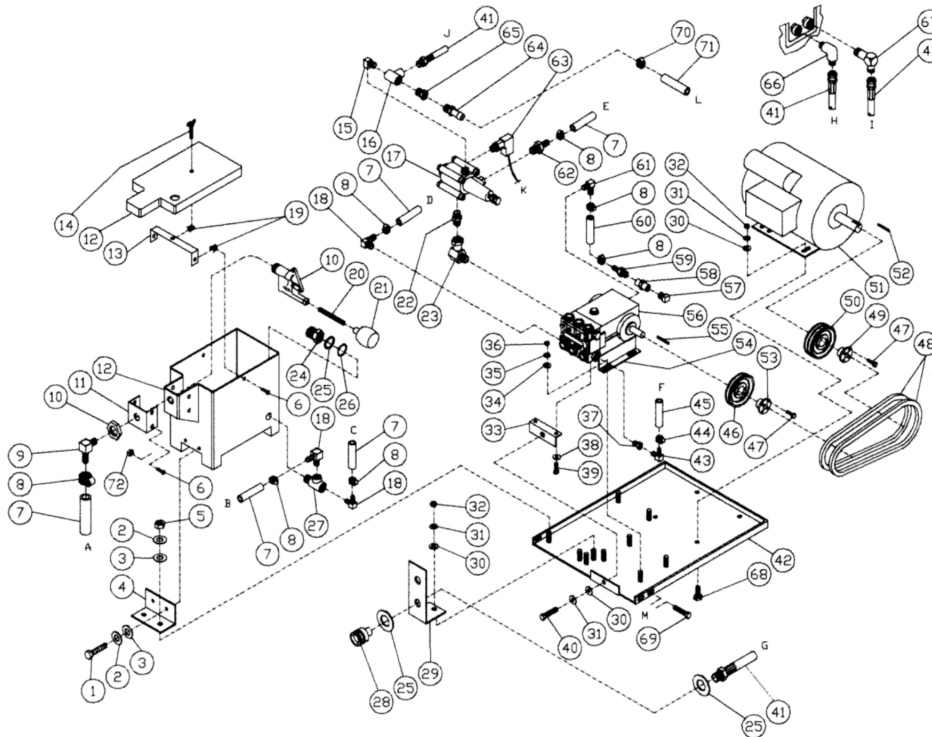

Id	Item #	Description	Quantity
1	27-0014	BOLT	4
2	29-0006	LOCKWASHER	8
3	28-0002	WASHER	12
4	20-0148	BRACKET	2
5	30-0002	NUT	4
6	27-2930	SCREW	6
7	15-0007	HOSE *(THREE FEET REQUIRED)	1
8	42-0011	HOSE CLAMP	7

Id	Item #	Description	Quantity
9	23-0053	ELBOW	1
10	22-0058	FLOAT VALVE	1
11	20-0188	FLOAT BRACKET	1
12	12-0035	FLOAT TANK	1
13	56-0020	LID BRACKET	1
14	27-2953	WING SCREW	1
15	24-0105	ELBOW	2
16	24-0026	TEE	1
17	8-0012	REGULATING UNLOADER	1
18	23-0050	ELBOW	3
19	30-2104	NUT/U-CLIP	3
20	31-3318	STUD	1
21	22-0059	FLOAT	1
22	24-0002	HEX NIPPLE	1
23	24-0046	ELBOW	1
24	23-0016	BUSHING	1
25	28-0050	WASHER	4
26	26-0001	GASKET	1
27	23-0058	TEE	1
28	17-0004	QUICK CONNECT SOCKET	1
29	20-0145	BRACKET	1
30	28-0003	WASHER (2004-0M11)	4
30	28-0022	WASHER (3004-0M11 & 3004-0M31)	4
31	29-0007	LOCKWASHER	7

Id	Item #	Description	Quantity
31	29-0007	LOCKWASHER (3004-0M11 & 3004-0M31)	3
31	29-0008	LOCKWASHER (3004-0M11 & 3004-0M31)	4
32	30-0004	HEX NUT (2004-0M11)	4
32	30-0006	HEX NUT (3004-0M11 & 3004-0M31)	4
33	13-0079	PUMP TIGHTENER	1
34	28-0030	WASHER (2004-0M11)	8
34	28-0023	WASHER (3004-0M11 & 3004-0M31)	8
35	29-0008	LOCKWASHER	8
36	30-0006	HEX NUT	8
37	23-0056	REDUCER	1
38	29-0055	LOCKWASHER	4
39	27-8471	BOLT	4
40	27-0526	BOLT	1
41	15-0070	HOSE	2
42	20-0143	PUMP/MOTOR MOUNT PLATE	1
43	23-0051	HOSE BARB	1
44	42-0004	HOSE CLAMP	1
45	15-0079	HOSE *(THREE FEET REQUIRED)	1
46	10-0026	SHEAVE-PUMP (2004-0M11)	1
46	10-0035	SHEAVE-PUMP (3004-0M11 & 3004-0M31)	1
47	27-0014	BOLT	4
48	11-0006	BELT (2004-0M11)	2
48	11-0030	BELT (3004-0M11 & 3004-0M31)	2
49	9-0010	BUSHING-MOTOR (2004-0M11)	1
49	9-0008	BUSHING-MOTOR (3004-0M11 & 3004-0M31)	1

Id	Item #	Description	Quantity
50	10-0029	SHEAVE-MOTOR (2004-0M11)	1
50	10-0030	SHEAVE-MOTOR (3004-0M11 & 3004-0M31)	1
51	2-0054	MOTOR (2004-0M11)	1
51	2-0055	MOTOR (3004-0M11)	1
51	2-0015	MOTOR (3004-0M31)	1
52	43-0039	KEY (W/MOTOR)	1
53	9-0017	BUSHING-PUMP	1
54	46-0066	PUMP FOOT	2
55	43-0028	KEY (W/PUMP)	1
56	3-0008	PUMP (2004-0M11)	1
56	3-0011	PUMP (3004-0M11 & 3004-0M31)	1
57	24-0009	PLUG	1
58	23-0002	CONNECTOR	1
59	23-0069	HOSE BARB	1
60	15-0020	HOSE *(FOUR FEET REQUIRED)	1
61	23-0123	ELBOW	1
62	23-0105	HOSE BARB	1
63	850-0173	PRESSURE SWITCH	1
64	22-0046	**POP OFF	1
65	23-0017	BUSHING	1
66	24-0074	ELBOW	1
67	24-0075	ELBOW	1
68	27-0117	BOLT	4
69	27-0415	BOLT	1
70	42-0003	HOSE CLAMP	1
71	15-0003	HOSE *(THREE FEET REQUIRED)	1

Id	Item #	Description	Quantity
72	30-0154	LOCKNUT	4

*MUST ORDER IN ONE FOOT LENGTHS

**WHEN ORDERING, PLEASE STATE MODEL OF MACHINE FOR PRESSURE SETTING



HU-3004-0M11 / HU-3004-0M11 (sn:15611-99999999)

PUMP ASSEMBLY

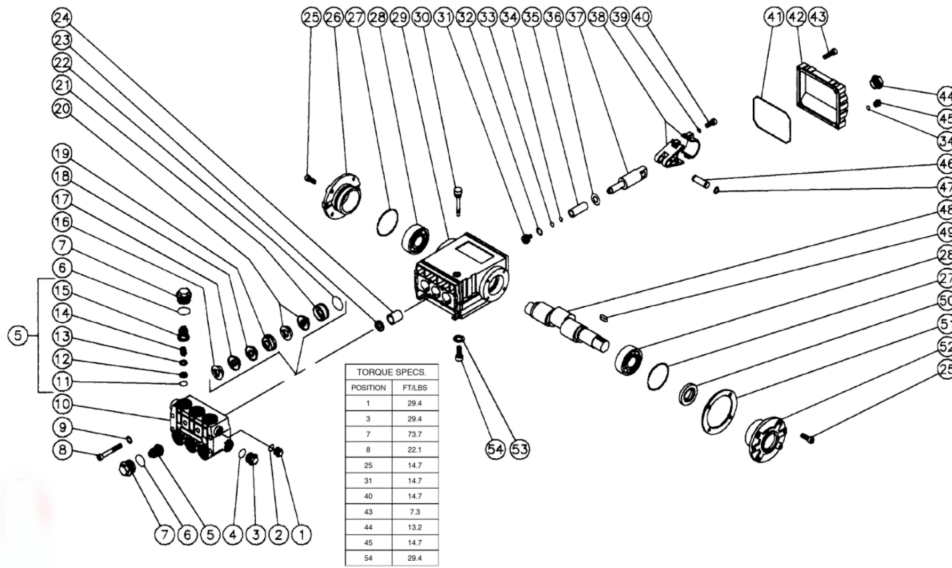

Id	Item #	Description	Quantity
1	39-0018	PLUG	1
2	28-0600	WASHER	1
3	39-0019	PLUG	1
4	28-0601	WASHER	1
5	N/A	VALVE ASSEMBLY (11-15) (SEE 70-0009)	6
6	25-0012	O-RING	6
7	39-0021	VALVE PLUG	6
8	27-8185	BOLT	8
9	28-0210	LOCKWASHER	8
10	46-0061	PUMP MANIFOLD	1
11	N/A Sep.	O-RING (SEE 70-0009)	6
12	N/A SEP.	VALVE SEAT (SEE 70-0009)	6
13	N/A SEP.	VALVE PLATE (SEE 70-0009)	6
14	N/A Sep.	VALVE SPRING (SEE 70-0009)	6
15	N/A SEP.	VALVE CAGE (SEE 70-0009)	6
16	N/A SEP.	HEAD RING (SEE 850-0122)	3
17	N/A SEP.	V-PACKING (SEE 850-0122)	3

Id	Item #	Description	Quantity
18	N/A SEP.	V-PACKING SUPPORT (SEE 850-0122)	3
19	46-0659	INTERMEDIATE SEAL RING	3
20	N/A SEP.	LOW PRESSURE SEAL (SEE 850-0122)	3
21	46-0057	SEAL RETAINER	3
22	25-0015	O-RING	3
23	26-0047	OIL SEAT	3
24	9-0029	BUSHING	3
25	27-8431	BOLT	8
26	46-0336	CRANKCASE COVER-CLOSED	1
27	25-0013	O-RING	2
28	48-0012	TAPER ROLLER BEARING	2
29	46-0047	CRANKCASE	1
30	46-0144	OIL DIPSTICK	1
31	46-0069	PISTON BOLT	3
32	28-0400	WASHER	3
33	25-0014	O-RING	4
34	46-0109	BACK-UP RING	3
35	46-0052	PLUNGER	3
36	46-0146	FLINGER WASHER	3
37	46-0054	PISTON ROD	3
38	46-0051	CONNECTING ROD	3
39	29-0154	LOCKWASHER	6
40	27-8435	BOLT	6
41	25-0339	O-RING COVER	1
42	46-0295	CRANKCASE COVER	1
43	27-8404	BOLT	5
44	46-0114	OIL LEVEL INDICATOR	1
45	39-0017	PLUG	1
46	43-0032	CONNECTING ROD PIN	3
47	46-0103	RETAINING RING	6
48	46-0050	CRANKSHAFT	1
49	43-0048	KEY	1
50	26-0049	OIL SEAL	1
51	46-0113	SHIM	2
52	46-0296	CRANKCASE COVER-OPEN	1
53	29-0055	LOCKWASHER	4
54	27-8471	BOLT	4
KIT	70-0009	VALVE KIT (INC. 6 EACH OF 11-15)	
KIT	852-0122	PACKING KIT (INC. 3 EACH OF 16, 17, 18, 20,22)	



HU-3004-0M11 / HU-3004-0M11 (sn:15611-99999999)

UNLOADER ASSEMBLY

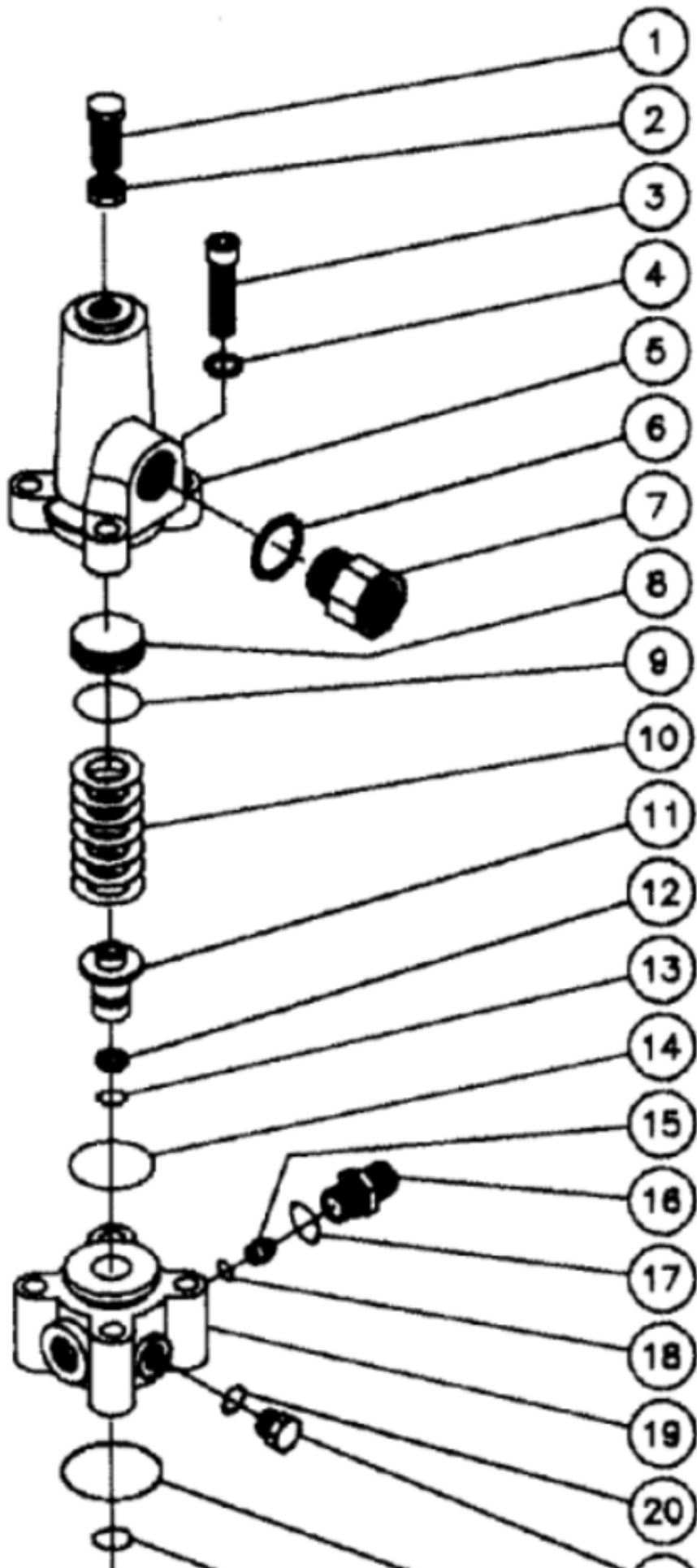

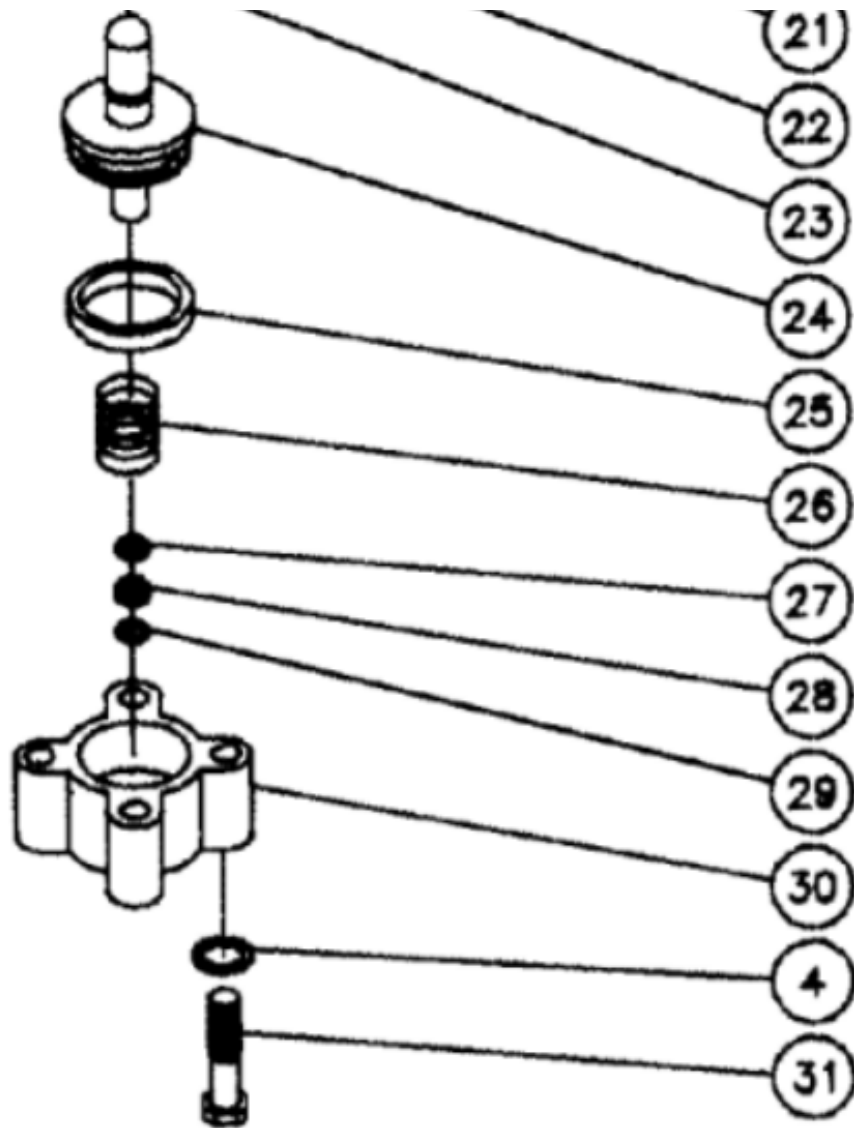

Id	Item #	Description	Quantity
1	27-8077	BOLT	1
2	30-3010	HEX NUT	1
3	27-8434	BOLT	4
4	29-0154	LOCKWASHER	8
5	8-0138	UPPER BODY	1
6	8-0277	WASHER	1
7	8-0125	BY-PASS RESTRICTOR	1
8	8-0135	SPRING GUIDE	1
9	25-0118	O-RING	1
10	49-0026	SPRING	1
11	8-0145	VALVE SEAT	1
12	8-0141	BACK-UP RING	1
13	25-0121	O-RING	1
14	25-0117	O-RING	1
15	8-0126	FLOW BALANCER	1

Id	Item #	Description	Quantity
16	8-0130	NIPPLE	1
17	25-0052	O-RING	1
18	25-0119	O-RING	1
19	8-0137	MIDDLE BODY	1
20	25-0114	O-RING	2
21	39-0017	HEX PLUG	2
22	25-0056	O-RING	1
23	25-0120	O-RING	1
24	8-0136	PISTON ASSEMBLY	1
25	26-0104	SEAL	1
26	49-0027	SPRING	1
27	8-0139	WASHER	1
28	26-0105	SEAL	1
29	8-0140	BACK-UP RING	1
30	8-01034	LOWER BODY	1
31	27-8037	BOLT	4
	70-0013	UNLOADER REPAIR KIT (INC. 9, 11, 13, 14, 17, 18, 20, 22-26, 28, 29)	
	852-0014	UNLAODER ORIFICE KIT (INC. 7, 15, 16)	



HU-3004-0M11 / HU-3004-0M11 (sn:15611-99999999)

PRESSURE SWITCH

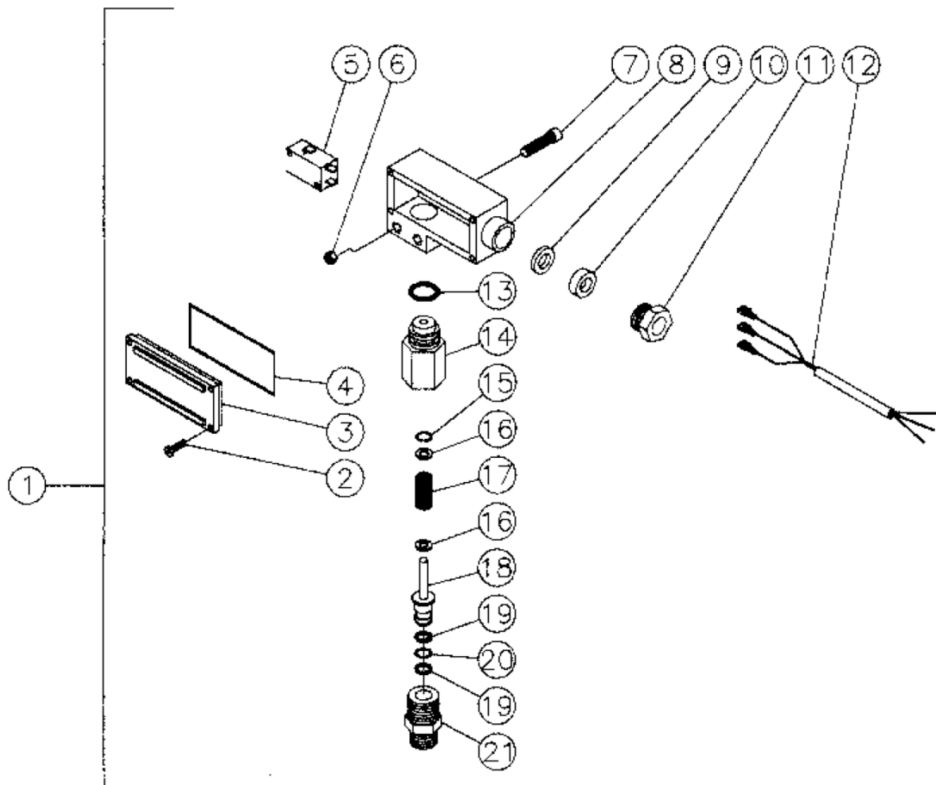

Id	Item #	Description	Quantity
1	850-0173	PRESSURE SWITCH COMPLETE	1
2	N/A	SCREW	4
3	N/A	COVER	1
4	N/A	O-RING	1
5	N/A	MICRO SWITCH	1
6	N/A	HEX NUT	2
7	N/A	SCREW	2
8	N/A	HOUSING	1
9	N/A	WASHER SPACER	1
10	N/A	GASKET/SEAL	1
11	N/A	BUSHING NUT	1
12	N/A	WIRE ASSEMBLY	1

Id	Item #	Description	Quantity
13	N/A	O-RING	1
14	N/A	SPRING HOUSING	1
15	N/A SEP.	O-RING (SEE 70-0007)	1
16	28-0218	WASHER SPACER	2
17	49-0107	SPRING	1
18	N/A	PISTON	1
19	N/A SEP.	BACK-UP RING (SEE 70-0007)	2
20	N/A SEP.	O-RING (SEE 70-0007)	1
21	N/A	HEX NIPPLE	1
	70-0007	O-RING KIT (INC. 15, 19, 20)	



HU-3004-0M11 / HU-3004-0M11 (sn:15611-99999999)

CONTROL PANEL

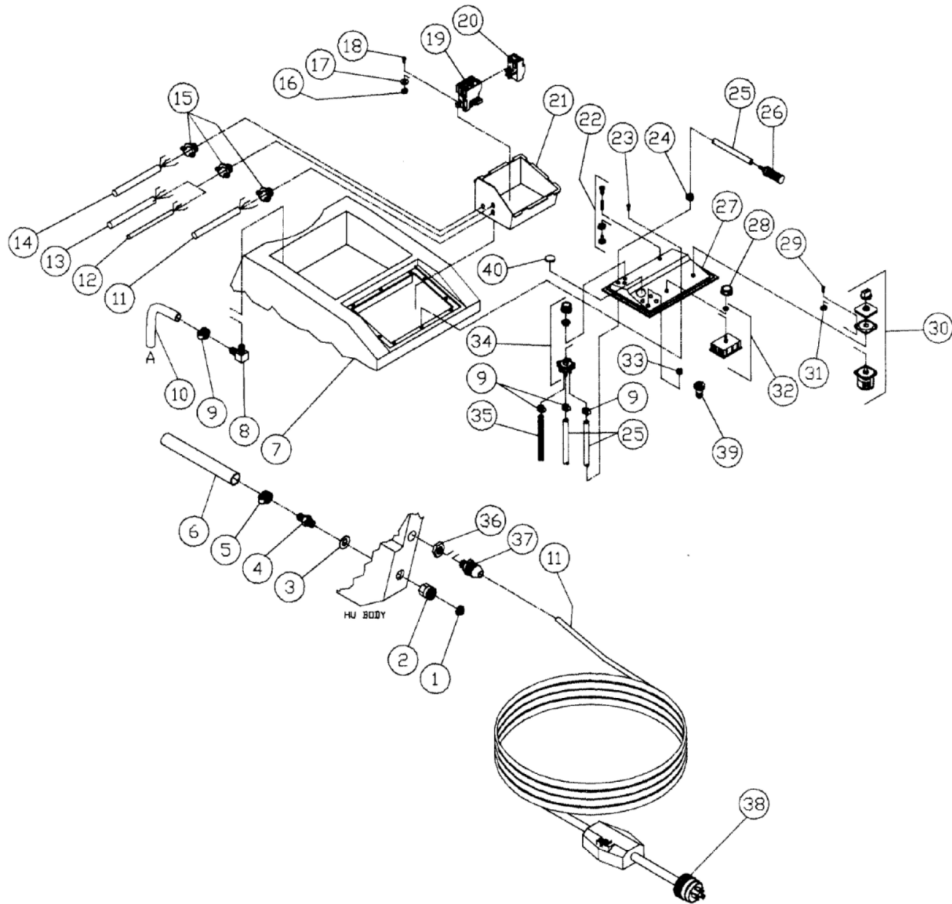

Id	Item #	Description	Quantity
1	19-0001	INLET FILTER	1
2	23-0001	GARDEN HOSE SWIVEL	1
3	28-0051	WASHER	1
4	23-0045	HOSE BARB	1
5	42-0011	HOSE CLAMP	1
6	15-0007	HOSE *(THREE FEET REQUIRED)	1
7	62-0006	HOUSING	1
8	23-0123	ELBOW	1
9	42-0004	HOSE CLAMP	4
10	15-0020	HOSE *(FOUR FEET REQUIRED)	1

Id	Item #	Description	Quantity
11	32-0334	CORD W/GFCI (35 FEET) (2004-0M11)	1
11	32-0021	CORD *(SIXTEEN FEET REQUIRED) (3004-0M11)	1
11	32-0023	CORD *(SIXTEEN FEET REQUIRED) (3004-0M31)	1
12	850-0173	PRESSURE SWITCH	1
13	32-0247	CORD *(SIX FEET REQUIRED)	1
14	32-0022	CORD *(THREE FEET REQUIRED) (2004-0M11)	1
14	32-0021	CORD *(THREE FEET REQUIRED) (3004-0M11)	1
14	32-0023	CORD *(THREE FEET REQUIRED) (3004-0M31)	1
15	32-0085	CONNECTOR	4
16	30-0052	HEX NUT (3004-0M11 & 3004-0M31)	2
17	28-0001	WASHER (3004-0M11 & 3004-0M31)	2
18	27-2048	BOLT (3004-0M11 & 3004-0M31)	2
19	32-0232	CONTACTOR (3004-0M11)	1
19	32-0235	CONTACTOR (3004-0M31)	1
20	32-0233	OVERLOAD RESET (3004-0M11)	1
20	32-0236	OVERLOAD RESET (3004-0M31)	1
	32-0267	REPLACEMENT COIL (3004-0M11)	1
	32-0266	REPLACEMENT COIL (3004-0M31)	1
21	62-0028	STARTER ENCLOSURE	1
22	32-0234	RESET BUTTON (3004-0M11 & 3004-0M31)	1
23	27-2930	SCREW	9
24	9-0028	BUSHING	2
25	15-0021	HOSE *(TEN FEET REQUIRED)	1
26	19-0050	CHEMICAL STRAINER	2
27	62-0027	INSTRUMENT PANEL	1
28	7-0054	THERMOSTAT KNOB	1
29	27-2771	SCREW	4
30	22-0033	SWITCH	1
31	30-0053	HEX NUT	4
32	22-0117	THERMOSTAT	1
33	33-0001	GROMMET	4
34	22-0090	CHEMICAL ADJUSTMENT VALVE	1
35	15-0079	HOSE *(THREE FEET REQUIRED)	1
36	32-0292	ELECTRICAL LOCKNUT	1
37	9-0046	BUSHING	1
38	32-0012	PLUG (3004-0M11)	1
38	32-0037	PLUG (3004-0M31)	1
39	18-0003	NOZZLE-0005 FOR HU-2004 (2004-0M11)	1
39	18-0004	NOZZLE-1505 FOR HU-2004 (2004-0M11)	1

Id	Item #	Description	Quantity
39	18-0153	NOZZLE-2505 FOR HU-2004 (2004-0M11)	1
39	18-0180	NOZZLE-4005 FOR HU-2004 (2004-0M11)	1
39	18-0028	NOZZLE-0004 FOR HU-3004 (3004-0M11 & 3004-0M31)	1
39	18-0029	NOZZLE-1504 FOR HU-3004 (3004-0M11 & 3004-0M31)	1
39	18-0030	NOZZLE-2504 FOR HU-3004 (3004-0M11 & 3004-0M31)	1
39	18-0031	NOZZLE-4004 FOR HU-3004 (3004-0M11 & 3004-0M31)	1
40	39-0044	ANTI-FREE PLUG	1