



# HOMEOWNER'S CARE AND OPERATION INSTRUCTIONS

RETAIN THESE INSTRUCTIONS FOR FUTURE REFERENCE

## DIRECT VENT SDDV-35/40 SERIES

DIRECT-VENT GAS FIREPLACE HEATERS

P/N 725,043M REV. NC 06/2006

### MODELS

#### Millivolt Models

SDDV-35NM  
SDDV-35PM  
SDDV-40NM  
SDDV-40PM

#### Electronic Models

SDDV-35NE  
SDDV-40NE

*A French manual is available upon request. Order P/N 725,043CF*

*Ce manuel d'installation est disponible en francais, simplement en faire la demande. Numéro de la pièce 725,043CF*

### ⚠ WARNINGS



- **Hot! Do not touch!** The glass and surfaces of this appliance will be hot during operation and will retain heat for a while after shutting off the appliance. Severe burns may result.
- Carefully supervise children in the same room as appliance.

- If small children are present in the home, it is recommended that this appliance be fitted with a screen door or screen panel kit. See *Page 17* for ordering information.

**WARNING: IF THE INFORMATION IN THIS MANUAL IS NOT FOLLOWED EXACTLY, A FIRE OR EXPLOSION MAY RESULT CAUSING PROPERTY DAMAGE, PERSONAL INJURY OR LOSS OF LIFE.**

**FOR YOUR SAFETY:** Do not store or use gasoline or other flammables or liquids in the vicinity of this or any other appliance.

**FOR YOUR SAFETY:** What to do if you smell gas:

- **DO NOT** light any appliance.
- **DO NOT** touch any electrical switches.
- Do not use any phone in your building.
- Immediately call your gas supplier from a neighbor's phone. Follow your gas suppliers instructions.
- If your gas supplier cannot be reached, call the fire department.

Installation and service must be performed by a qualified installer, service agency or the gas supplier.

**AVERTISSEMENT: ASSUREZ-VOUS DE BIEN SUIVRE LES INSTRUCTIONS DONNÉ DANS CETTE NOTICE POUR RÉDUIRE AU MINIMUM LE RISQUE D'INCENDIE OU POUR ÉVITER TOUT DOMMAGE MATÉRIEL, TOUTE BLESSURE OU LA MORT.**

**POUR VOTRE SÉCURITÉ:** Ne pas entreposer ni utiliser d'essence ni d'autre vapeurs ou liquides inflammables dans le voisinage de cet appareil ou de tout autre appareil.

**POUR VOTRE SÉCURITÉ:** Que faire si vous sentez une odeur de gaz:

- Ne pas tenter d'allumer d'appareil.
- Ne touchez à aucun interrupteur. Ne pas vous servir des téléphones se trouvant dans le bâtiment où vous vous trouvez.
- Evacuez la pièce, le bâtiment ou la zone.
- Appelez immédiatement votre fournisseur de gaz depuis un voisin. Suivez les instructions du fournisseur.
- Si vous ne pouvez rejoindre le fournisseur de gaz, appelez le service des incendies.

L'installation et service doit être exécuté par un qualifié installateur, agence de service ou le fournisseur de gaz.

Tested & Listed By



Beaverton Oregon USA

OTL Report No. 116-F-05-5

OMNI-Test Laboratories, Inc.

## ACCESSORY COMPONENTS

Product Reference Information			
Cat. No.	Model	Ship. Wt. (lbs)	Ship. Vol. (Cubic feet)
H4835	SDDV-35NM	TBD	18.3 cu. ft. 40.25 x 36.25 x 21.7"
H4836	SDDV-35PM	TBD	18.3 cu. ft. 40.25 x 36.25 x 21.7"
H4837	SDDV-35NE	TBD	18.3 cu. ft. 40.25 x 36.25 x 21.7"
H4838	SDDV-40NM	TBD	20.9 cu. ft. 41.62 x 40.25 x 21.7"
H4839	SDDV-40PM	TBD	20.9 cu. ft. 41.62 x 40.25 x 21.7"
H4840	SDDV-40NE	TBD	20.9 cu. ft. 41.62 x 40.25 x 21.7"

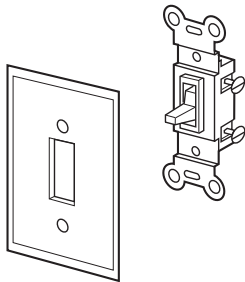

White Wall Switch Kit		
Cat. No.	Model No.	Description
85L87	FWSK	OFF/ON Wall Switch Kit

### OFF/ON Wall Switch Kit

The OFF/ON wall switch kit may be used to control the operation of the fireplace burner. Install the OFF/ON wall switch in a convenient location near the fireplace.

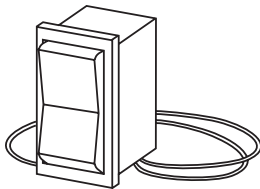

Rocker Switch Kit		
Cat. No.	Model No.	Description
80L41	FRS	Rocker Switch Kit

(ref. Form # 750,037M)

### Unit-Mountable Rocker Switch

This rocker switch kit can be installed directly in the gas valve mounting bracket (millivolt gas valve equipped fireplaces) to provide On/Off operation in lieu of a wall switch.



Remote Control Kit, Standard		
Cat. No.	Model No.	Description
H0249	RCL	Remote Control System (Standard)

(ref. Form # 750,127M)

### Standard Remote Control System

The Model RCL (Standard) Remote Control System, features a simplistic OFF/ON control function for the fireplace. This model includes a hand-held transmitter, a remote receiver with wall-mount cover plate and all hardware required to install the unit. The remote receiver can be wall or hearth mounted.

The transmitter has ON and OFF functions that are activated by pressing either button on the face of the transmitter. When a button on the transmitter is pressed, a signal light illuminates briefly to verify that a signal has been sent.

The Model RCL is designed to operate with all millivolt ignition systems, as well as electronic ignition systems. It may be installed with use for either natural gas or propane gas appliances. The RCL offers ease of installation and allows you to execute on-off commands to the fireplace effortlessly with one simple motion.

The Model RCL comes complete with detailed operating instructions.

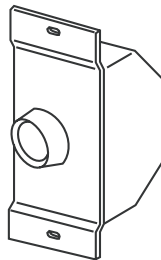

Variable Speed Wall Switch		
Cat. No.	Model No.	Description
045571H	VSWS	Variable Speed Wall Switch

### Variable Speed Wall Switch

Provides variable speed control if optional blower kit is purchased.



Remote Control Kit, Deluxe		
Cat. No.	Model No.	Description
H0251	RCL-STAT	Remote Control System (Deluxe)

(ref. Form # 750,129M)

### Deluxe Remote Control System

The Model RCL-T (Deluxe) Remote Control System has all of the features of the standard system along with an added easy to read LCD screen which presents access to many enhancements, including; battery power level indicator, timer, mode of operation, thermostatic display including room temperature in either Metric or English units, flame indicator and clock. Fully programmable, the Model RCL-T allows for virtual command over nearly all operational and temperature variables, using the hand held remote control transmitter.

The Model RCL-T (Deluxe) remote control system is installed in the same manner as the standard system, may be operated with electronic and millivolt systems with either natural gas or propane gas. The RCL-T comes complete with detailed operating instructions.

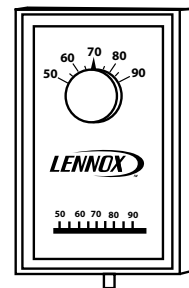

Wall Thermostat, Millivolt		
Cat. No.	Model No.	Description
89L36	WTK	Wall Thermostat Kit, White

### Wall Thermostat

The wall thermostat kit provides temperature control for optimum comfort.

NOTE: DIAGRAMS & ILLUSTRATIONS NOT TO SCALE.

## ACCESSORY COMPONENTS

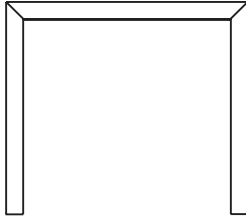

3 Piece Trim Kit		
Cat. No.	Model No.	Description
H0454	TK35EPB3	35" Polished Brass, SDDV-35
96K22	TK40PB3	40" Polished Brass, SDDV-40
H1814	TK35EBS	35" Brushed Stainless, SDDV-35
H1816	TK40BS3	40" Brushed Stainless, SDDV-40
H4822	TK35EC3	35" Charcoal, SDDV-35
H4823	TK40C3	40" Charcoal, SDDV-40

(ref. Form # 750,147M)

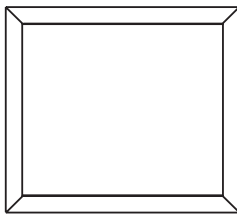

4 Piece Trim Kit		
Cat. No.	Model No.	Description
96K17	TK35PB4	35" 4 Piece Finish Trim Kit, Polished Brass, SDDV-35
96K18	TK40PB4	40" 4 Piece Finish Trim Kit, Polished Brass, SDDV-40

(ref. Form # 750,147M)

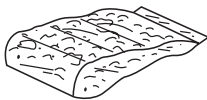

Decorative Firebox Accessories (all models)		
Cat. No.	Model No.	Description
88L53	FGE	Bag of Glowing Embers (1 oz. rockwool)
80L42	FDVS	Bag of Volcanic Stone

(FDVS ref. Form #750,010M)

### Bag of Glowing Embers

### Bag of Volcanic Stone

Replacement ember materials or volcanic stone are available for use with these appliances. Order kits as part of the periodic maintenance of the appliance.

* Assembled 8-Piece Louver Kits				
Polished Brass		Brushed Stainless		Models Where Used
Cat. #	Model	Cat. #	Model	
H1524	LK-500B	H1525	LK-500BS	SDDV-35
H1526	LK-600B	H1527	LK-600BS	SDDV-40

(ref. Form # 750,166M)

\* Superior Nameplate Logo, 56L93, is not included.

### Polished Brass & Brushed Stainless Louvers Kits

These kits include a top 4-louver assembly and a bottom 4-louver assembly. They provide a touch of elegance. These kits can be retrofitted to previously installed appliances.

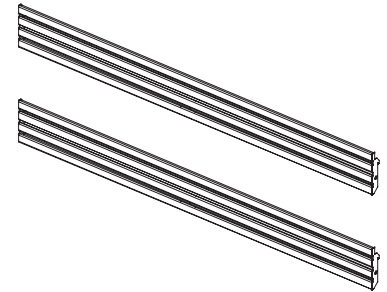

### Sunrise Style (upper grille shown)



### Crescent Style (lower grille shown)

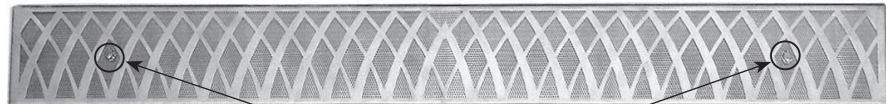

Knobs

Upper Grille Kits - SUNRISE			
Cat. #	Model	Description	Where Used
H3565	SUGK35C	35" Charcoal	SDDV-35
H3567	SUGK35SP	35" Satin Pewter	
H3573	SUGK40C	40" Charcoal	SDDV-40
H3575	SUGK40SP	40" Satin Pewter	

Upper Grille Kits - CRESCENTS			
Cat. #	Model	Description	Where Used
H3541	CUGK35C	35" Charcoal	SDDV-35
H3543	CUGK35SP	35" Satin Pewter	
H3549	CUGK40C	40" Charcoal	SDDV-40
H3551	CUGK40SP	40" Satin Pewter	

Lower Grille Kits - SUNRISE			
Cat. #	Model	Description	Where Used
H3569	SLGK35C	35" Charcoal	SDDV-35
H3571	SLGK35SP	35" Satin Pewter	
H3577	SLGK40C	40" Charcoal	SDDV-40
H3579	SLGK40SP	40" Satin Pewter	

(ref. Form # 750,202M)

Lower Grille Kits - CRESCENTS			
Cat. #	Model	Description	Where Used
H3545	CLGK35C	35" Charcoal	SDDV-35
H3547	CLGK35SP	35" Satin Pewter	
H3553	CLGK40C	40" Charcoal	SDDV-40
H3555	CLGK40SP	40" Satin Pewter	

### Decorative Upper And Lower Grille Kits

These decorative grilles are offered in two styles and four attractive finishes. The grilles fit on the face of the appliance in place of the standard louvers.

## ACCESSORY COMPONENTS

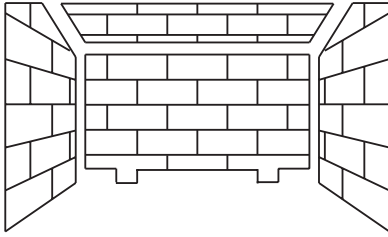

Brickaded Panel Liner Kits			
Cat. No.	Model No.	Description	Models
H0775	EBLK-35	Rustic	SDDV-35
H2028	EBLKC-35	Old Cottage	
H2025	EBLKH-35	Herringbone	
H5048	EBLKR-35	Boston Red	
H0776	EBLK-40	Rustic	SDDV-40
H2029	EBLKC-40	Old Cottage	
H2026	EBLKH-40	Herringbone	
H5049	EBLKR-40	Boston Red	

(ref. Form # 750,160M)

### Brickaded Liner Kits

The brickaded liner kits include ceramic panels of the side walls, the rear and the baffle of the firebox. The brickaded panels have brick-like features in relief.



Touch-Up Paint Kits (all models)		
Cat. No.	Model No.	Description
H4354	TPK-C	Touch-Up Paint (Charcoal)
98K67	TPK-T	Touch-Up Paint (Tan)

(TPK-C ref. Form # 504,216M)

### Touch-Up Paint Kit

Repair of minor scratches and discoloration of the appliance charcoal painted surfaces may be accomplished with the touch-up paint kit.

Eyebrow Hood Kits				
Polished Brass		Brushed Stainless		Models Where Used
Cat. #	Model	Cat. #	Model	
96K67	EB35PB	88L49	EB35BS	SDDV-35
96K68	EB40PB	88L50	EB40BS	SDDV-40

\* These hood kits replace the standard hood that comes with these fireplaces.

(ref. Form #504,142M)

### Polished Brass & Brushed Stainless Hood Kits

Attractive hoods are available in two styles. These hoods are designed to be fitted to the glass viewing sides of the appliance. In addition to providing an aesthetically pleasing appearance to your appliance installation, the hood reduces heat effects to decorative mantles and finish materials located above the fireplace opening. The hood kit replaces the standard hood that comes with these appliances and snaps into place. These kits can be retrofitted to previously installed appliances.

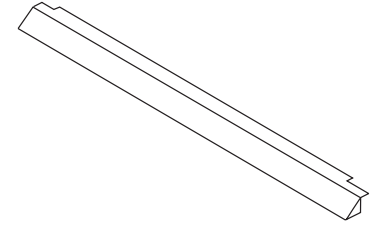

These hood kits replace the standard hood that comes with these fireplaces.

2- Piece Door Frame Kits				
Polished Brass		Brushed Stainless		Models Where Used
Cat. #	Model	Cat. #	Model	
26M88	2DFK35PB	26M91	2DFK35BS	SDDV-35
26M89	2DFK40PB	26M92	2DFK40BS	SDDV-40

(ref. Form # 750,098M)

### 2-Piece Door Trim Kits

These kits are designed to attach directly to the front face of the fireplace at the top and bottom edges of the glass enclosure panel.

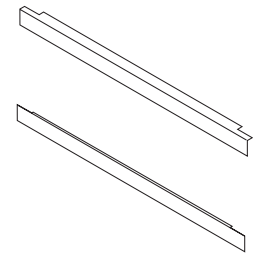

4 Piece Door Trim Kits				
Polished Brass		Brushed Stainless		Models Where Used
Cat. #	Model	Cat. #	Model	
26M83	4DFK40PB	26M86	4DFK40BS	SDDV-40

(ref. Form # 750,098M)

### Door Frame Kits

A decorative door frame kit is available for use with these appliances. It is designed to attach directly to the front face of the appliance at the four edges of the glass enclosure panel resulting in the appearance of a picture frame.

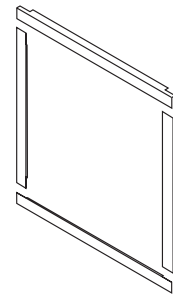

Forced Air Blower Kits		
Cat. No.	Model No.	Description
80L84	FBK-100	Blower, Standard (single speed)
80L85	FBK-200	Blower, Variable Speed (w/wall-mounted switch)
80L86	FBK-250	Blower, Variable Speed (w/unit-mounted switch)
94L89	FBK-100-36	Blower, Standard, 36 Pack
94L90	FBK-200-36	Blower Kit - Variable Speed with Wall Switch 36 Pack
H0543	FBK-250-36	Blower Kit - Variable Speed with Thermo Snap Switch 36 Pack

(ref. Form # 750,028M & 750,029M)

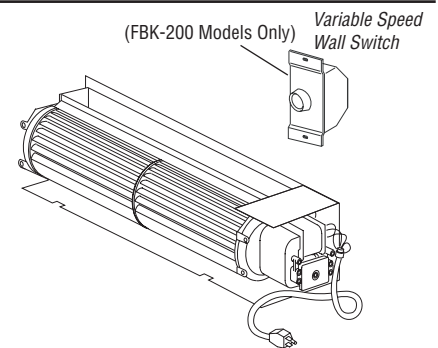

### Forced Air Kit

The FBK-100 blower provides constant velocity forced air circulation. The FBK-200 assembly with variable speed, wall-mountable switch provides variable speed forced air circulation. The FBK-250 assembly with variable speed unit-mountable switch, also provides variable speed forced air circulation.

## ACCESSORY COMPONENTS

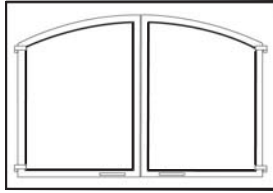

Arch Design

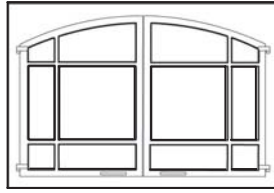

Arch Pane Design

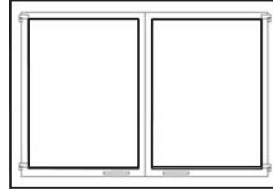

Square Design

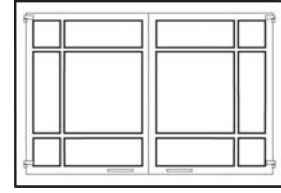

Square Pane Design

Square Design Door Kits			
Cat. No.	Model	Description	Model Series
H0950	SD40C	40" Sq. Doors, Charcoal	SDDV-40
H0951	SD40TI	40" Sq. Doors, Textured Iron	
H0952	SD40SP	40" Sq. Doors, Satin Pewter	
H0953	SD40AB	40" Sq. Doors, Antique Brass	
H0958	SD35EC	35" Elite Sq. Doors, Charcoal	SDDV-35
H0959	SD35ETI	35" Elite Sq. Doors, Textured Iron	
H0960	SD35ESP	35" Elite Sq. Doors, Satin Pewter	
H0961	SD35EAB	35" Elite Sq. Doors, Antique Brass	
Square Pane Design Door Kits			
H0966	SPD40C	40" Sq. Pane Doors, Charcoal	SDDV-40
H0967	SPD40TI	40" Sq. Pane Doors, Textured Iron	
H0968	SPD40SP	40" Sq. Pane Doors, Satin Pewter	
H0969	SPD40AB	40" Sq. Pane Doors, Antique Brass	
H0974	SPD35EC	35" Elite Sq. Pane Doors, Charcoal	SDDV-35
H0975	SPD35ETI	35" Elite Sq. Pane Doors, Text. Iron	
H0976	SPD35ESP	35" Elite Sq. Pane Doors, Satin Pewt.	
H0977	SPD35EAB	35" Elite Sq. Pane Doors, Ant. Brass	

Arch Design Door Kits			
Cat. No.	Model	Description	Models
H0862	AD40C	40" Arch Doors, Charcoal	SDDV-40
H0863	AD40TI	40" Arch Doors, Textured Iron	
H0864	AD40SP	40" Arch Doors, Satin Pewter	
H0865	AD40AB	40" Arch Doors, Antique Brass	
H0870	AD35EC	35" Arch Doors, Charcoal	SDDV-35
H0871	AD35ETI	35" Arch Doors, Textured Iron	
H0872	AD35ESP	35" Arch Doors, Satin Pewter	
H0873	AD35EAB	35" Arch Doors, Antique Brass	
Arch Pane Door Kits			
H0934	APD40C	40" Arch Pane, Charcoal	SDDV-40
H0935	APD40TI	40" Arch Pane, Textured Iron	
H0936	APD40SP	40" Arch Pane, Satin Pewter	
H0937	APD40AB	40" Arch Pane, Antique Brass	
H0942	APD35EC	35" Arch Pane, Charcoal	SDDV-35
H0943	APD35ETI	35" Arch Pane, Textured Iron	
H0944	APD35ESP	35" Arch Pane, Satin Pewter	
H0945	APD35EAB	35" Arch Pane, Antique Brass	

(ref. Form # 775.169M)

### Style View Screen Doors -

These Style View screen doors come in 4 beautiful styles. They are easy to install and will not require hardware to attach them to the standard glass door frame. The screens prevent direct contact with the hot glass surface. The door includes heavy duty magnet door latches and functional twin-pane screen doors.

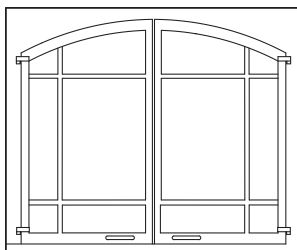

Style View Tall Arch Pane Screen Door Kits			
Cat. #	Model	Description	Models
H3537	TAPD35EC	35", Charcoal	SDDV-35
H3539	TAPD35ESP	35", Satin Pewter	SDDV-35
H3529	TAPD40C	40", Charcoal	SDDV-40
H3531	TAPD40SP	40", Satin Pewter	SDDV-40

(ref. Form # 750.200M)

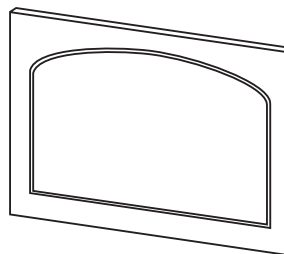

Arch Door Kits				
Polished Brass		Brushed Stainless		Models Where Used
Cat. #	Model	Cat. #	Model	
81L34	ADK35CPB	98L68	ADK35CBS	SDDV-35
81L35	ADK40CPB	98L69	ADK40CBS	SDDV-40

(ref. Form # 750.021M)

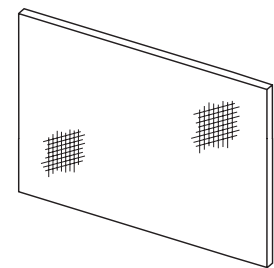

Screen Panel Kits		
Cat. #	Model	Description
88L52	HG35E	35" Screen Panel Kit
96K32	HG40	40" Screen Panel Kit

(ref. Form # 750.101M)

**Tall Arch Pane Screen Door Kits** - These decorative and functional twin-pane screen doors are offered in two attractive finishes and fit on the face of the appliance over the glass doorframe and also covers the control compartment (replaces lower louver assembly). The screens prevent direct contact with the hot glass surface.

### Arch Door Kits -

The arch door kits (no screen) are easy to install and do not require hardware to attach them to the standard door frame. The decorative arch kits can NOT be used in conjunction with the screen panel kit.

### Screen Panel Kits -

These screen panels can be installed on the glass enclosure panel to prevent contact with the hot glass surface. The screen panel kits cannot be used in conjunction with either of the arch door kits or door frame kits.

## REPLACEMENT PARTS LIST

Item #	Description	SDDV-35		SDDV-40	
		Part No.	Qty.	Part No.	Qty.
1	Hood, Standard	97K51	1	97K52	1
2	Louver Assembly, Top, Charcoal	H3376	1	H3377	1
3	* Louver Assembly, Bottom, Charcoal	H3379	1	H3380	1
4	Enclosure, Glass Front (Complete)	91L18	1	H3724	1
5	Nameplate, Superior (logo)	56L93	1	56L93	1
6	Door Hook Latch	69L21	2	69L21	2
7	Log Set (Complete)	H5044	1	H5045	1
8	Burner Assembly	55M30	1	55M30	1
9	Orifice, Main Burner - Natural Gas	69L96	1	18L40	1
9	Orifice, Main Burner - Propane Gas	39L10	1	37G00	1
10	Bag of Glowing Embers (Rockwool)	88L53	1	88L53	1
10	Bag of Decorative Volcanic stone	80L42	1	80L42	1
11	Gas Line Flexible Connector, FFGC	93L32	1	93L32	1
12	Gasket, Venturi Tube Mounting	43K85	1	43K85	1

\* Superior Nameplate Logo, 56L93, is not included.

### Gas Controls - SIT Millivolt

Item #	Description	Natural Gas		Propane Gas	
		Part No.	Qty.	Part No.	Qty.
13	Gas Valve, SIT	43K07	1	88J53	1
14	Piezo Igniter (includes wire)	91K94	1	91K94	1
15	Pilot Assembly	69L17	1	69L18	1
16	Pilot Generator	60J79	1	60J79	1
17	Thermocouple	74L57	1	74L57	1
18	Pilot Tube	74L56	1	74L56	1
19	Electrode and Cable	74L58	1	74L58	1
20	Pilot Shield	H3737	1	H3737	1
21	Gas Train Assembly, MV, SDDV-35NM	H4368	1	-----	1
21	Gas Train Assembly, MV, SDDV-35PM	-----	1	H4369	1
21	Gas Train Assembly, MV, SDDV-40NM	H4984	1	-----	1
21	Gas Train Assembly, MV, SDDV-40PM	-----	1	H4370	1

### Gas Controls - Honeywell Electronic

Item #	Description	Natural Gas		Propane Gas	
		Part No.	Qty.	Part No.	Qty.
22	Gas Valve, Honeywell	62L18	1	62L19	1
23	Pilot Assembly	62L14	1	62L15	1
24	Transformer	42J32	1	42J32	1
25	Igniter Assembly (Kit)	87L54	1	87L54	1
26	Pilot Shield	H1596	1	H1596	1
27	Gas Train Assembly, Electronic, SDDV-35NE	H4371	1	-----	1
27	Gas Train Assembly, Electronic, SDDV-40NE	H4912	1	-----	1

# REPLACEMENT PARTS DIAGRAMS

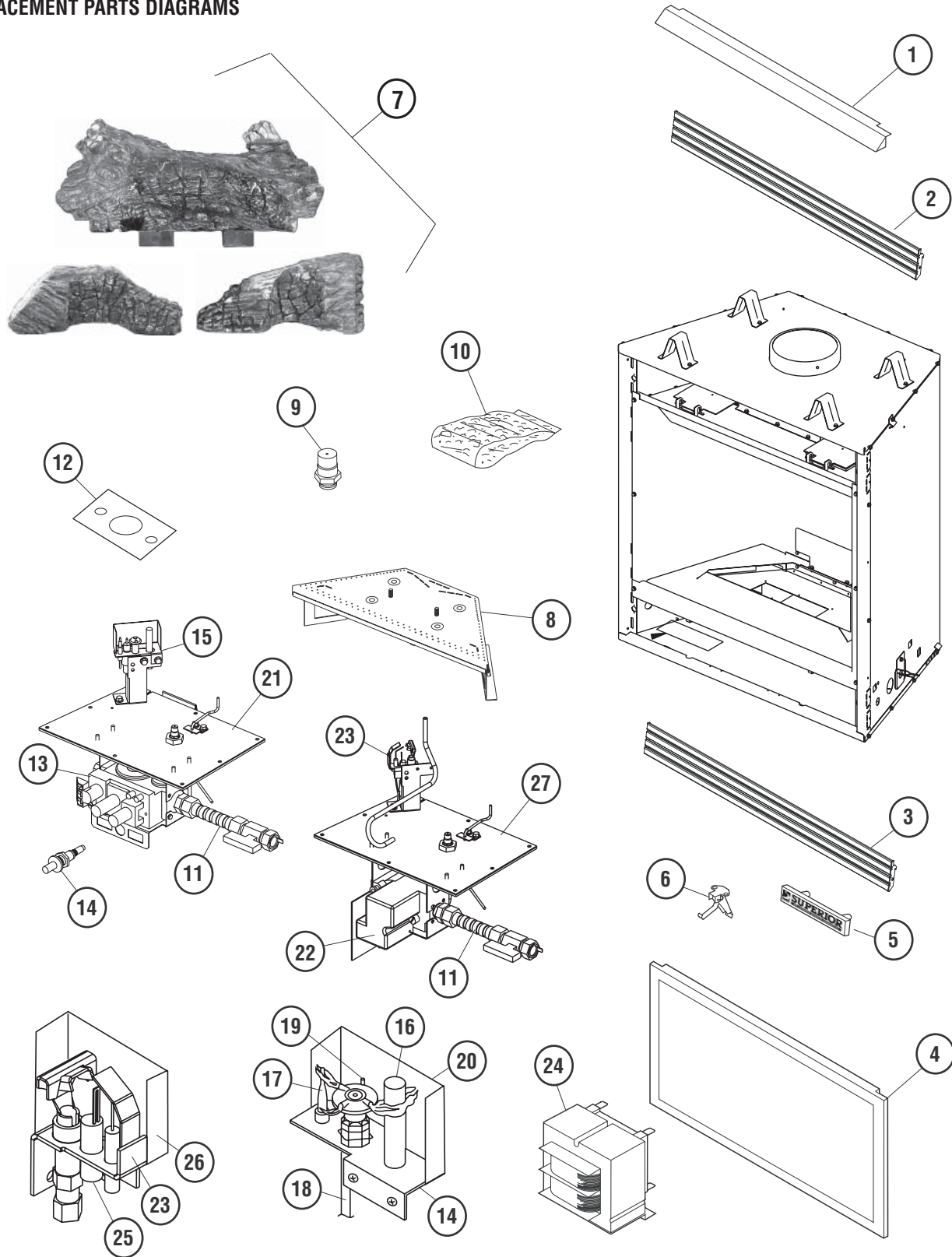

LHP reserves the right to make changes at any time, without notice, in design, materials, specifications, prices and also to discontinue colors, styles and products. Consult your local distributor for fireplace code information.