

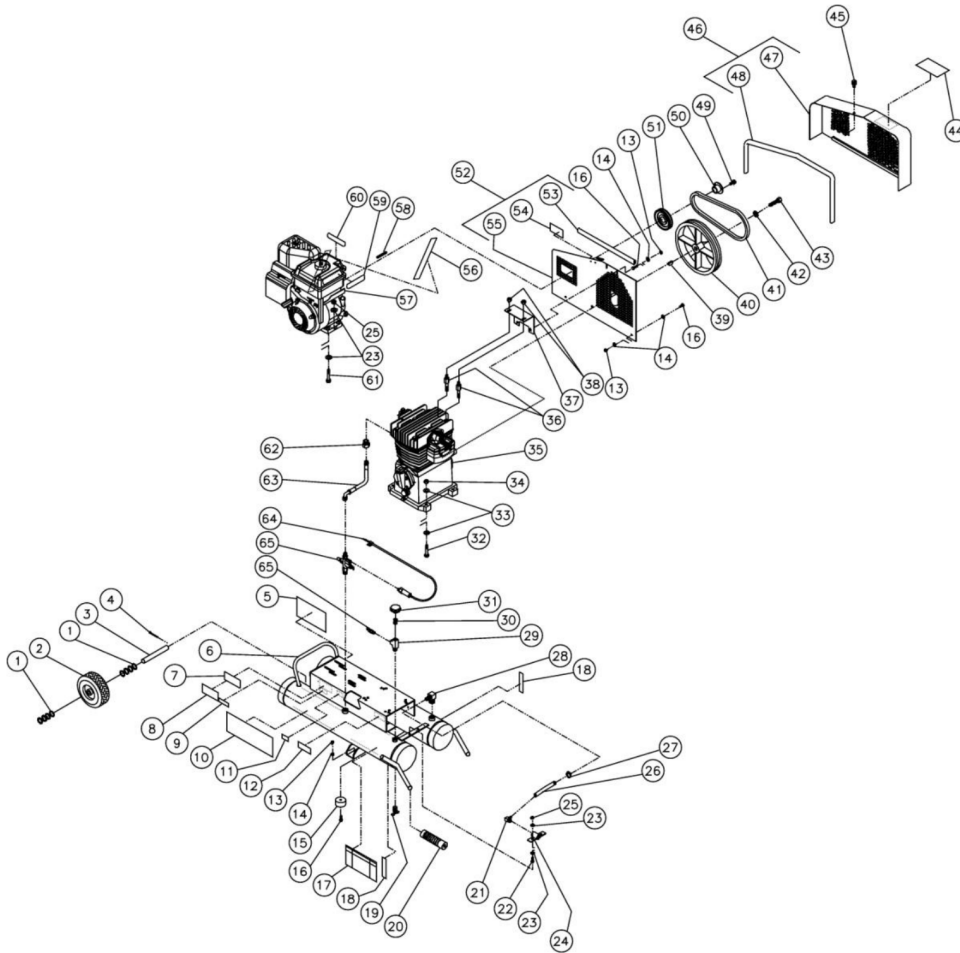

AP1-PI65-08M / AP1-PI65-08M (sn:0-396320)

## FRAME ASSEMBLY



Id	Item #	Description	Quantity	Rev	Comments
1	28-0008	WASHER	8		
2	14-0079	WHEEL	1		
3	20-0420	AXLE	1		
4	43-0092	COTTER PIN	2		
5	34-0817	DECAL-MAINTENANCE INSTRUCTIONS	1		
6	12-011701	AIR TANK ASSEMBLY	1		
7	N/A	DECAL-DATA PLATE	1		
8	N/A	DECAL-CLEAR LAMINATE	1		
9	N/A	DECAL-SERIAL NUMBER	1		
10	34-1123	DECAL-JOB PRO	1		

Id	Item #	Description	Quantity	Rev	Comments
11	34-0521	DECAL-AMERICAN FLAG	1		
12	34-0823	DECAL-WARNING: HOT SURFACE	1		
13	30-0155	LOCKNUT	7		
14	28-0002	WASHER	10		
15	14-0069	ISOLATOR	2		
16	27-0015	BOLT	7		
17	34-0819	DECAL-DANGER/WARNING/CAUTION	1		
18	34-0815	DECAL-DRAIN TANK	2		
19	23-0312	DRAIN VALVE	2		
20	7-0143	HANDLE GRIPS	2		
21	23-0050	ELBOW	1		
22	27-0067	BOLT	2		
23	28-0003	WASHER	12		
24	20-0421A01	REGULATOR MOUNTING BRACKET	1		
25	30-0157	LOCKNUT	6		
26	15-0007	HOSE *(ONE FOOT REQUIRED)	1		
27	42-0011	HOSE CLAMP	2		
28	23-0053	HOSE BARB	1		
29	23-0309	STREET TEE	1		
30	23-0111	ADAPTER	1		
31	22-0257	PRESSURE GAUGE	1		
32	27-0121	BOLT	4		
33	28-0023	WASHER	8		
34	30-0159	LOCKNUT	4		
35	3-0175	COMPRESSOR	1		
36	27-8920	BOLT	2		
37	20-0475A01	BELTGUARD BRACKET	1		
38	30-3023	NUT	2		
39	43-0102	KEY	1		
40	10-0100	FLYWHEEL (W/COMPRESSOR)	1		
41	11-0040	DRIVE BELT	1		
42	28-1032	FLATWASHER FLYWHEEL (W/COMPRESSOR)	1		
43	27-8032	BOLT (W/COMPRESSOR)	1		
44	34-0821	DECAL-OPERATING INSTRUCTIONS	1		
45	33-0197	FASTENER	1		
46	854-0009	BELTGUARD ASSEMBLY (INC. 47, 48)	1		
47	N/A Sep.	BELTGUARD COVER (SEE 854-0009)	1		
48	33-0020	EDGING *(FOUR FEET REQUIRED)	1		
49	27-0015	BOLT (W/BUSHING)	2		

Id	Item #	Description	Quantity	Rev	Comments
50	9-0009	BUSHING	1		
51	10-0105	DRIVE PULLEY	1		
52	854-0007	BELTGUARD BACK ASSEMBLY (INC. 53-55)	1		
53	33-0020	EDGING *(TWO FEET REQUIRED)	1		
54	34-0575	DECAL-WARNING: BELTGUARD IN PLACE	1		
55	N/A Sep.	BELTGUARD BACK (SEE 854-0007)	1		
56	34-0816	DECAL-CHECK OIL	1		
57	1-0109	ENGINE-6.5 H.P. INTEK I/C	1		
58	43-0073	KEY	1		
59	34-0588	DECAL-ENGINE FUEL	1		
60	34-0130	DECAL-WARNING: MUFFLER HOT	1		
61	27-0070	BOLT	4		
62	23-0016	BUSHING	1		
63	15-0183	HOSE	1		
64	33-0353	THROTTLE CONTROL	1		
65	23-0313	PILOT VALVE	1		
66	22-0228	SAFETY RELIEF VALVE	1		

\*MUST ORDER IN ONE FOUR LENGTHS



AP1-PI65-08M / AP1-PI65-08M (sn:0-396320)

## COMPRESSOR PUMP

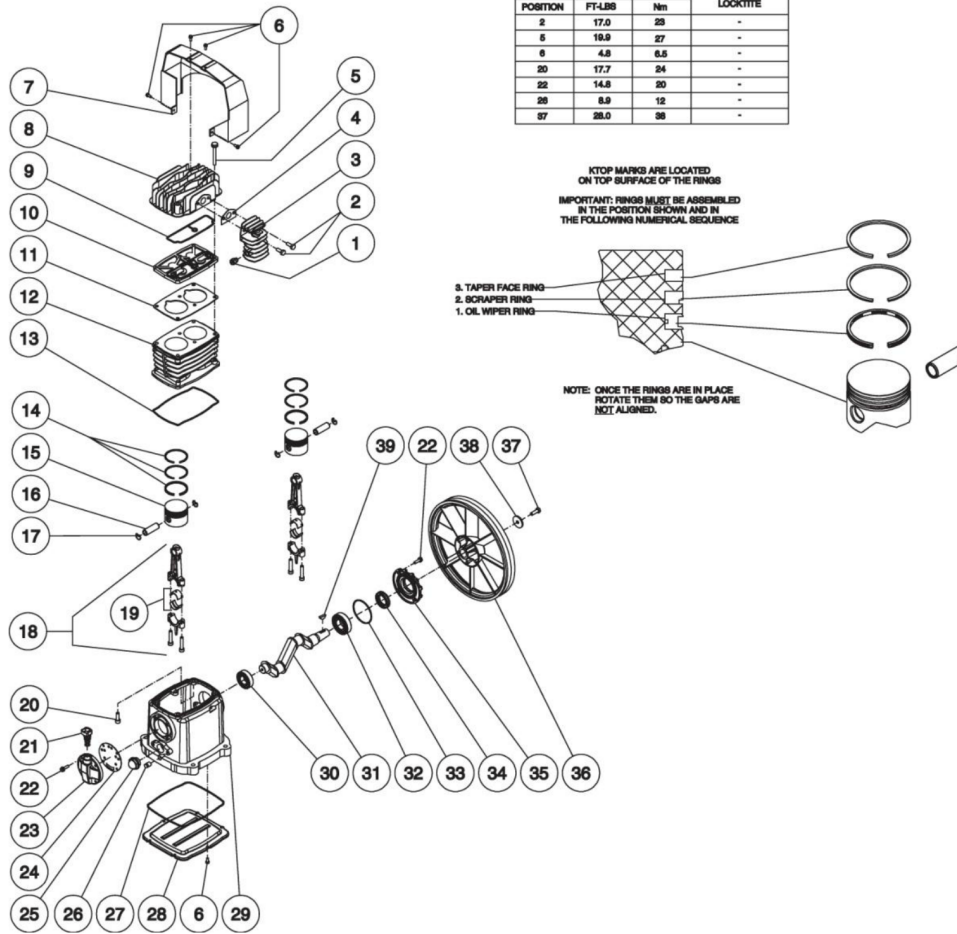

TORQUE SPECIFICATIONS			REQUIRED LOCKTITE
POSITION	FT-LBS	Nm	
2	17.0	23	-
5	19.9	27	-
6	4.6	6.3	-
20	17.7	24	-
22	14.6	20	-
26	8.9	12	-
37	28.0	38	-

KTOP MARKS ARE LOCATED  
ON TOP SURFACE OF THE RINGS  
IMPORTANT: RINGS MUST BE ASSEMBLED  
IN THE POSITION SHOWN AND IN  
THE FOLLOWING NUMERICAL SEQUENCE

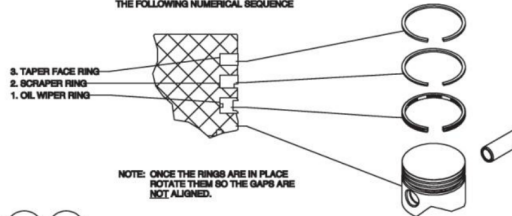

Id	Item #	Description	Quantity	Rev	Comments
1	22-0253	EASY START VALVE	1		
2	27-8032	SCREW	2		
3	46-1171	AFTER COOLER	1		
4	N/A Sep.	AFTER COOLER GASKET (SEE 70-0393)	1		
5	27-9577	SCREW	6		
6	27-9575	SCREW	10		
7	46-1197	AIR SHROUD	1		
8	46-1172	HEAD	1		
9	N/A Sep.	HEAD GASKET (SEE 70-0393)	1		
10	22-0388	HOLDER PLATE VALVE	1		

Id	Item #	Description	Quantity	Rev	Comments
11	N/A Sep.	CYLINDER GASKET (SEE 70-0393)	1		
12	46-1170	CYLINDER	1		
13	N/A Sep.	CRANKCASE GASKET (SEE 70-0393)	1		
14	70-0392	RING SET - 65 MM	2		
14	70-0268	RING SET - 65.4 MM	2		
15	N/A	PISTON	2		
16	N/A	WRIST PIN	2		
17	N/A	SNAP RING	2		
18	N/A	CONNECTING ROD	2		
19	N/A	CONNECTING ROD BEARING	2		
20	27-8194	SCREW	4		
21	46-0818	CRANKCASE FILL PLUG W/ O-RING	1		
22	27-8002	BOLT	8		
23	46-0819	OIL FILL END CAP	1		
24	N/A Sep.	OIL FILL END CAP GASKET (SEE 70-0393)	1		
25	46-0820	SIGHT GLASS	1		
26	39-0106	OIL DRAIN PLUG	1		
27	N/A Sep.	OIL PAN O-RING (SEE 70-0393)	1		
28	N/A	OIL PAN	1		
29	N/A	CRANKCASE	1		
30	48-0060	BALL BEARING	1		
31	N/A	PISTON CRANKSHAFT	1		
32	48-0024	BALL BEARING	1		
33	N/A Sep.	END CAP GASKET (SEE 70-0393)	1		
34	26-0208	CRANKSHAFT SEAL	1		
35	46-1169	FRONT END CAP	1		
36	10-0131	FLYWHEEL	1		
37	27-8033	BOLT	1		
38	28-1032	WASHER	1		
39	43-0102	WOODRUFF KEY	1		
	70-0393	GASKET KIT (INCLUDES 4, 9, 11, 13, 24, 27, 33)			



AP1-PI65-08M / AP1-PI65-08M (sn:0-396320)

## AUTO DRAIN AX-0001

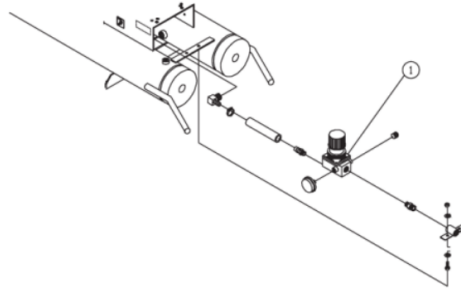

Id	Item #	Description	Quantity	Rev	Comments
1	22-0231	REGULATOR-ADJUSTABLE	1		





AP1-PI65-08M / AP1-PI65-08M (sn:0-396320)

## AUTO DRAIN AX-0002

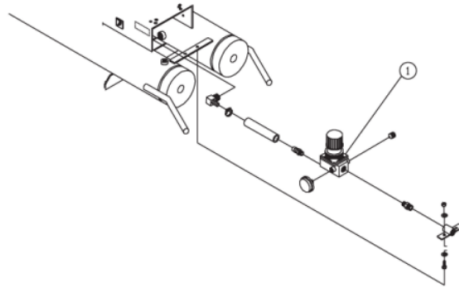

Id	Item #	Description	Quantity	Rev	Comments
1	22-0231	REGULATOR-ADJUSTABLE	1		





AP1-PI65-08M / AP1-PI65-08M (sn:0-396320)

## AUTO DRAIN AX-0003

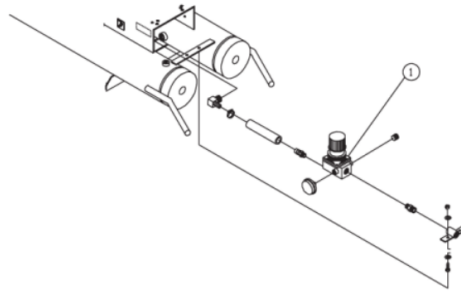

Id	Item #	Description	Quantity	Rev	Comments
1	22-0231	REGULATOR-ADJUSTABLE	1		





AP1-PI65-08M / AP1-PI65-08M (sn:0-396320)

## AUTO DRAIN AX-0004

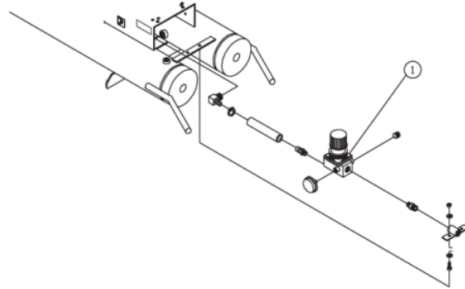

Id	Item #	Description	Quantity	Rev	Comments
1	22-0231	REGULATOR-ADJUSTABLE	1		





AP1-PI65-08M / AP1-PI65-08M (sn:0-396320)

## AIR REGULATOR AX-0014

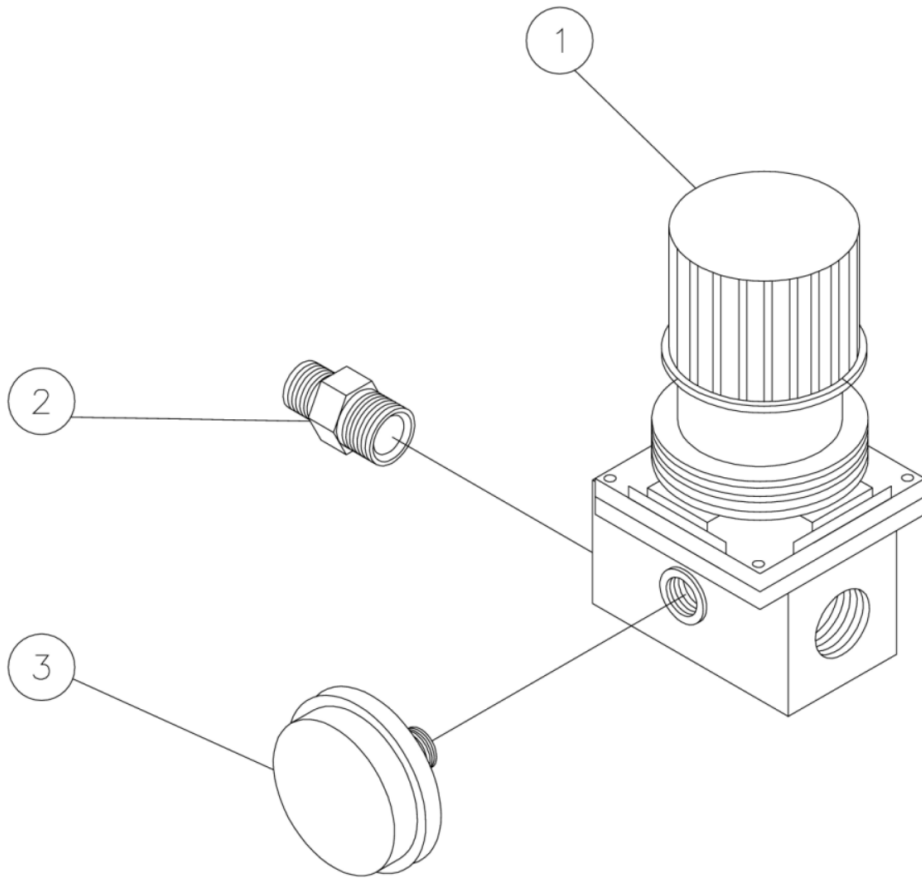

Id	Item #	Description	Quantity	Rev	Comments
1	22-0231	REGULATOR	1		
2	24-0010	NIPPLE	1		
3	22-0257	PRESSURE GUAGE	1		

