

FIGURE 8 - PARTS LIST: MK-3000K CONCRETE SAW PARENT A - P/N 166449

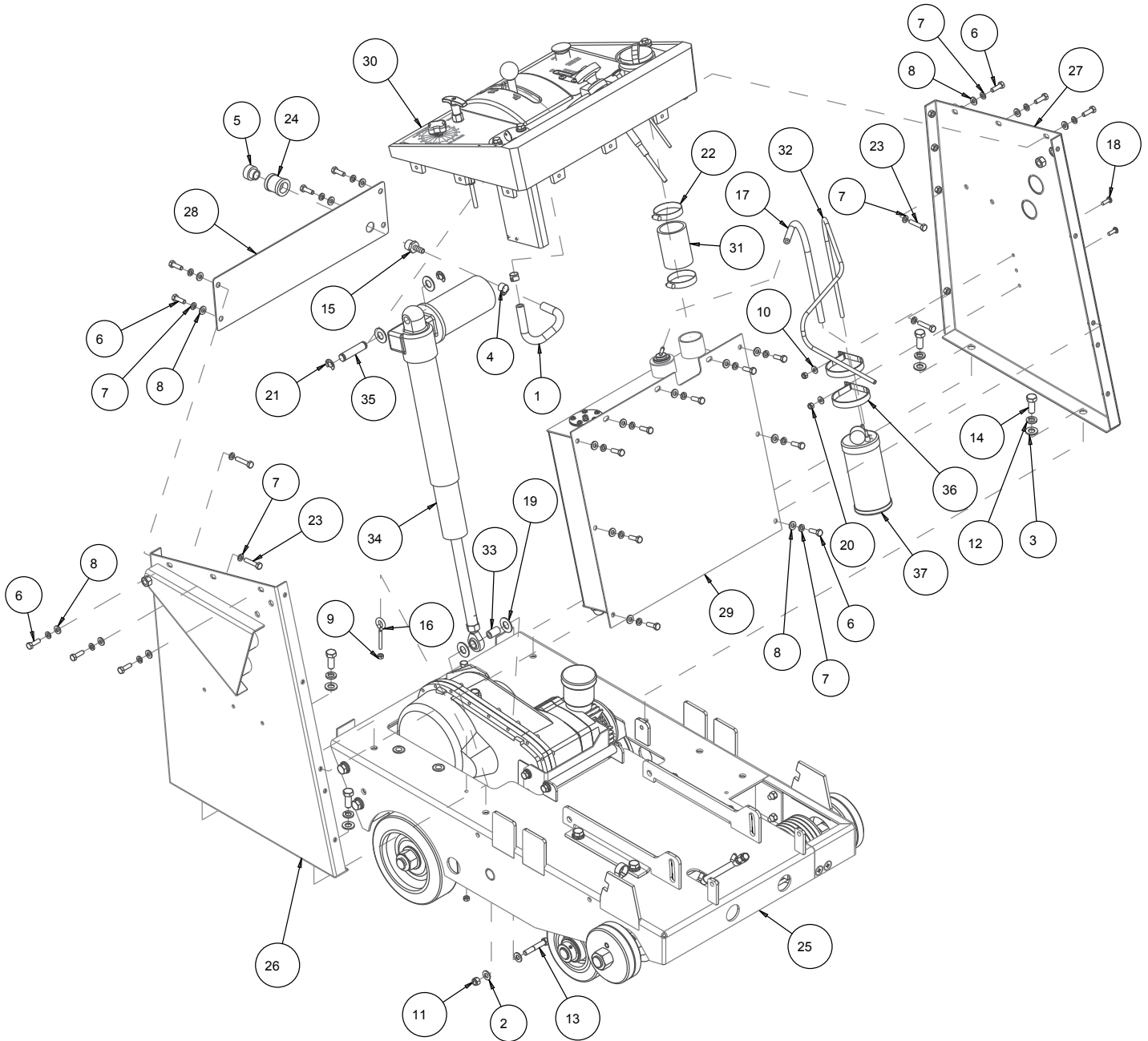

FIGURE 8 - PARTS LIST: MK-3000K CONCRETE SAW PARENT A - P/N 166449

ITEM NO.	DESCRIPTION	PART #	QTY.
1	HOSE, 3/8 X 5/8 VINYL, 12"	150845	1
2	WASHER, 3/8 SAE FLAT	150923	2
3	WASHER, 1/2 SAE FLAT	150924	4
4	CLAMP, 5/8 HOSE	151198	2
5	FITTING, 1/2 MNPT X 3/4 FNH	151322	1
6	SCREW, HEX, 5/16 - 18 X 1	151743	19
7	WASHER, LOCK, SPLIT, 5/16	151747	23
8	WASHER, FLAT, SAE, 5/16	151754	19
9	NUT, 1/4-20 HEX	151893	2
10	WASHER, FLAT, SAE, 1/4	151915	2
11	NUT, NYLK HEX, 3/8 - 16	152505	1
12	WASHER, 1/2 SPLIT LOCK	153524	4
13	SCREW, HEX HEAD, CAP 3/8 - 16 X 2-1/4	153529	1
14	SCREW, 1/2 - 13 X 1 - 1/4 HEX HEAD CAP	153532	4
15	FITTING, 1/2 MNPT X 3/8 BARB	153653	1
16	EYEBOLT, 1/4 - 20 X 2	153887	1
17	HOSE, 1/4 FUEL, 10"	154163	1
18	SCREW, PAN HD, 1/4-20 X 3/4	157523	2
19	WASHER, FLAT, 5/8 SAE	158350	4
20	NUT, HEX, NYLK, 1/4-20	159857	2
21	RING, 5/8 E-STYLE RETAINING	160815	2
22	CLAMP, 1 - 5/16 TO 2 - 1/4 HOSE	162816	2
23	BOLT, 5/16 - 18 X 1-1/2 HEX HEAD TAP	162819	4
24	FITTING, 1/2 NPT COUPLER	164208	1
25	ASSY, FRAME SUB	166326	1
26	PANEL, TOWER R/H	166351	1
27	PANEL, TOWER L/H	166352	1
28	PANEL, TOWER UPPER BACK	166353	1
29	ASSY, FUEL TANK, GASOLINE	166357	1
30	ASSY, CONTROL PANEL, 3000K	166700	1
31	HOSE, 2.0 ID FUEL FILL (COMP)	167213	1
32	HOSE, FUEL, 3/16, LOW PERM, 36"	167674	1
33	BUSHING, 3/8 X 5/8 X 1	167993	1
34	ASSY, ACTUATOR	167994	1
35	PIN, MOUNTING, 5/8	167998	1
36	CLAMP, CUSHION LOOP, 3	170398	2
37	CANISTER, CARBON, 400CC	172607	1

FIGURE 9 - PARTS LIST: MK-3000K CONCRETE SAW PARENT B - P/N 166449

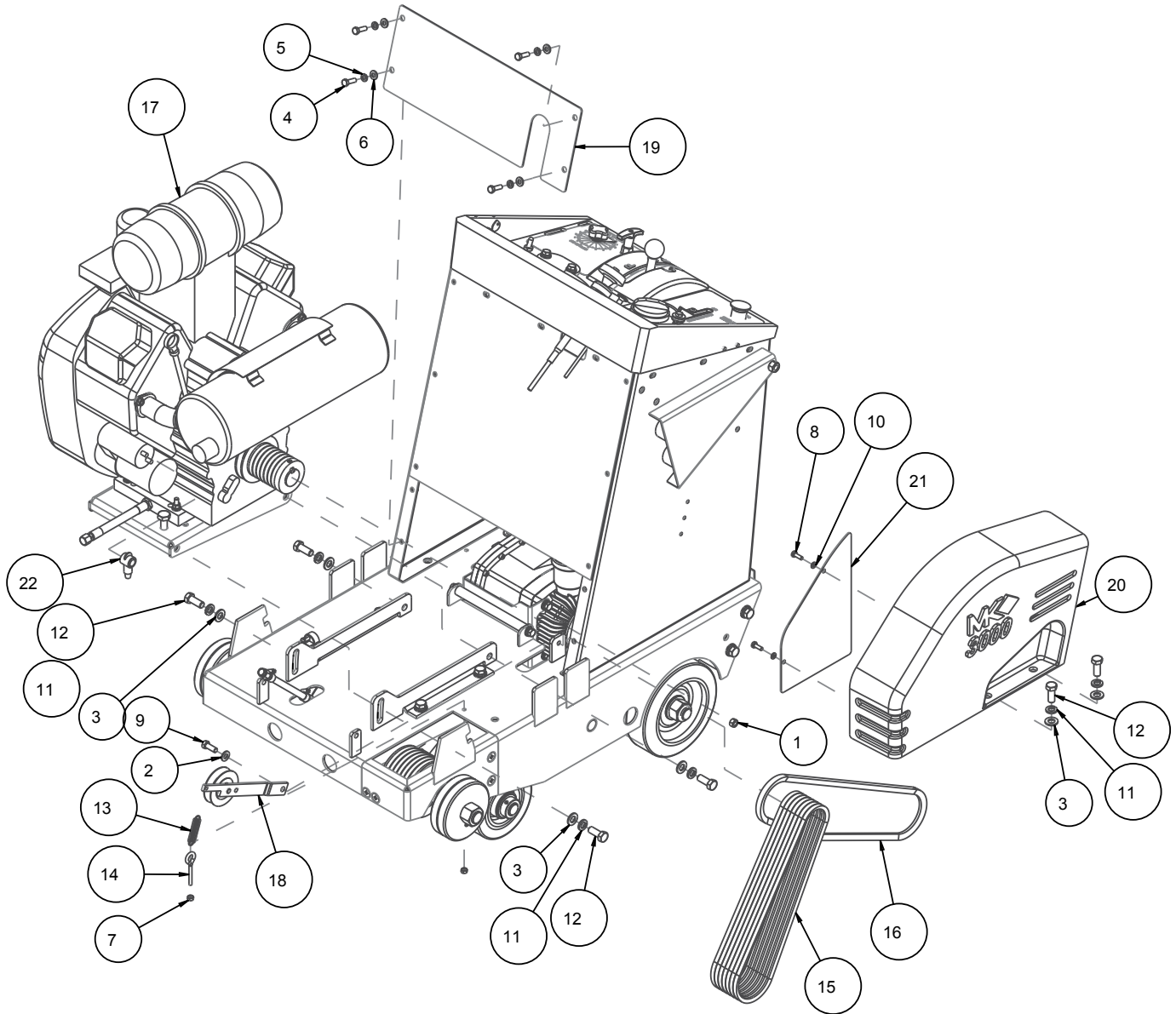

FIGURE 9 - PARTS LIST: MK-3000K CONCRETE SAW PARENT B - P/N 166449

ITEM NO.	DESCRIPTION	PART #	QTY.
1	NUT, 3/8-16 HEX	101188	1
2	WASHER, 3/8 SAE FLAT	150923	1
3	WASHER, 1/2 SAE FLAT	150924	6
4	SCREW, HEX HEAD, 5/16-18 X 1	151743	4
5	WASHER, LOCK, SPLIT, 5/16	151747	4
6	WASHER, FLAT, SAE, 5/16	151754	4
7	NUT, 1/4-20 HEX	151893	2
8	SCREW, 1/4-20 X 3/4 HEX HEAD	152370	2
9	SCREW, HEX HD CAP, 3/8-16 X 1	152507	1
10	WASHER, 1/4 SPLIT LOCK	152591	2
11	WASHER, 1/2 SPLIT LOCK	153524	6
12	SCREW, 1/2-13 X 1-1/4 HEX HEAD CAP	153532	6
13	SPRING, EXTENSION, 9/16OD X 2.5L X .072WIRE	153807	1
14	EYEBOLT, 1/4-20 X 2	153887	1
15	BELT, V, 3VX375	157891	7
16	BELT, AX-44	161418	1
17	ASSY, ENGINE, 3000K	162738	1
18	ASSY, TRANS IDLER	164163	1
19	PANEL, TOWER LOWER FRONT	166356	1
20	CASTING, BELT GUARD (COMP)	166362	1
21	PLATE, BLT GRD, INNER	166637	1
22	INSULATOR, 8-2GA, RED	169355	1

FIGURE 10 - PARTS LIST: MK-3000K CONCRETE SAW PARENT C - P/N 166449

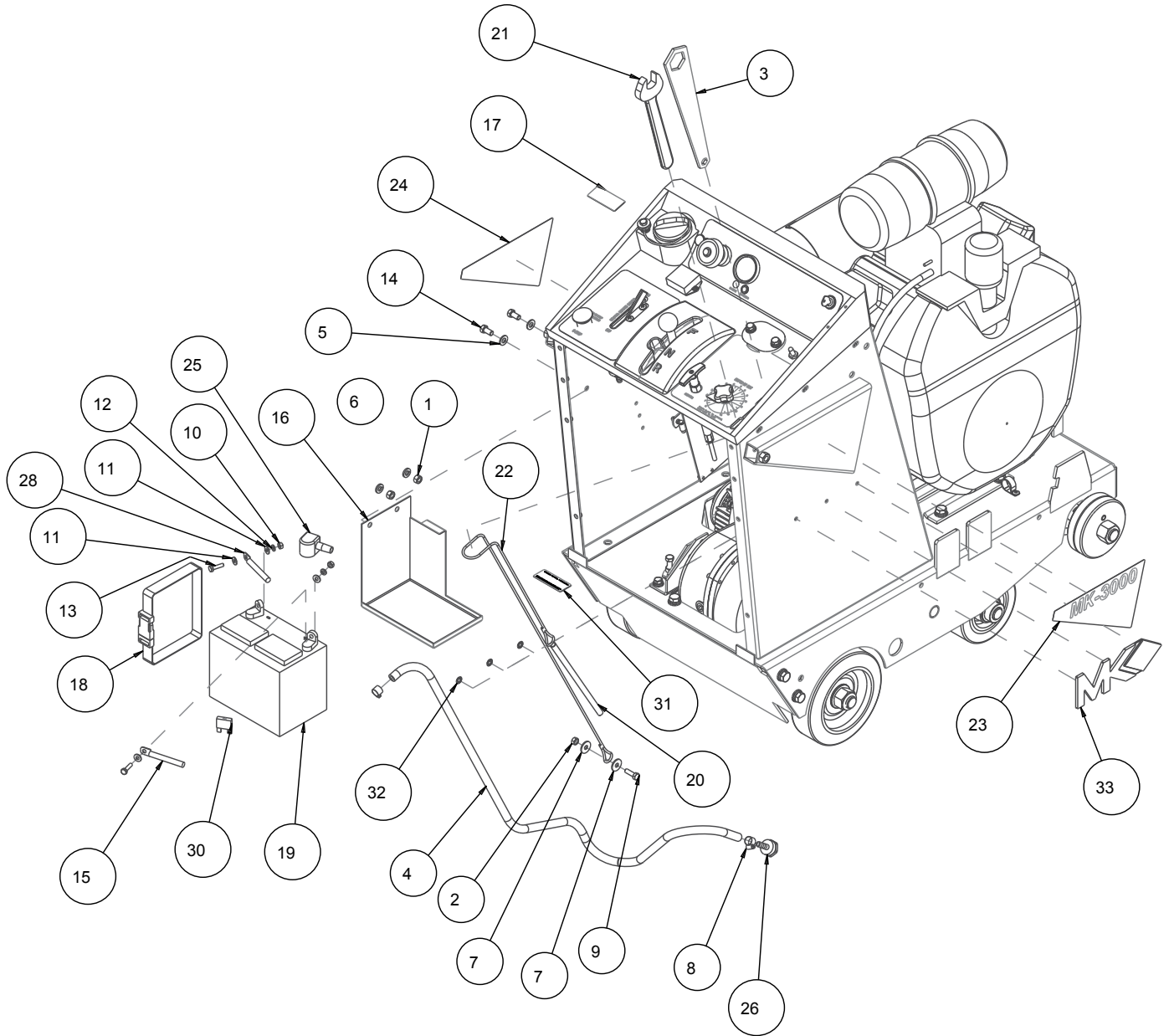
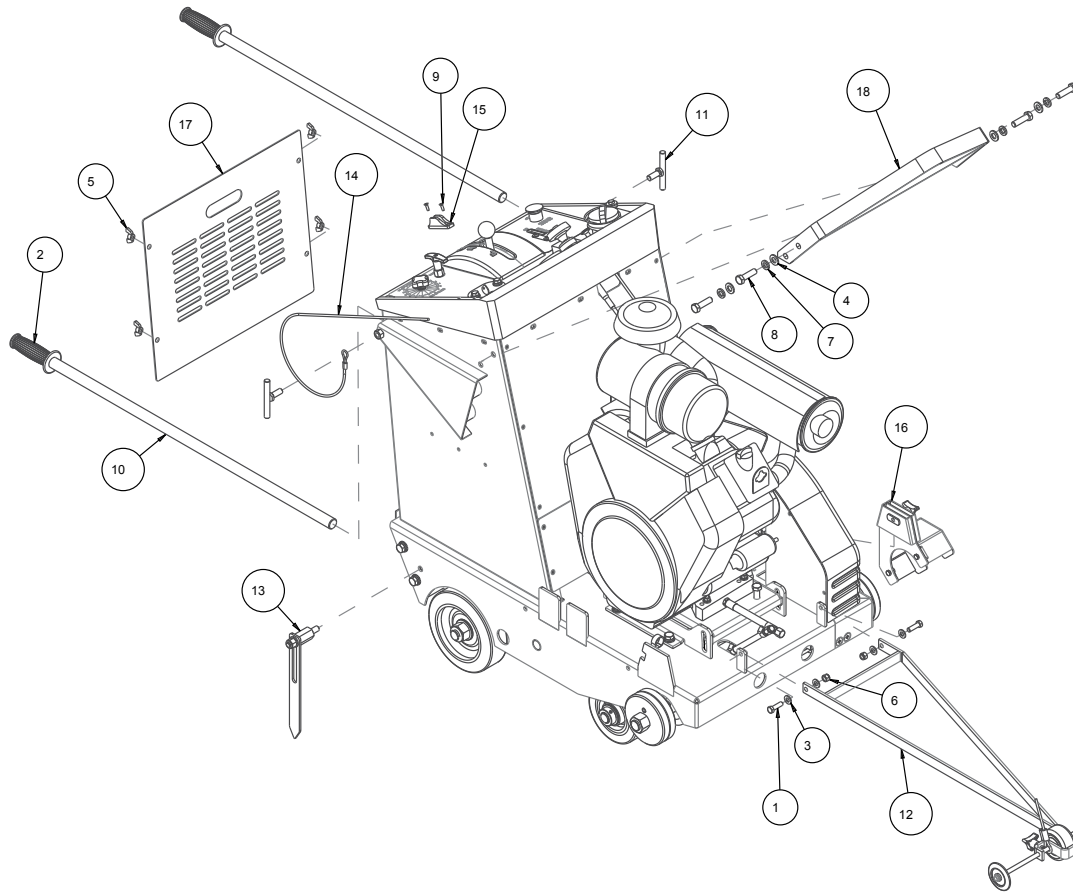

FIGURE 10 - PARTS LIST: MK-3000K CONCRETE SAW PARENT C - P/N 166449

ITEM NO.	DESCRIPTION	PART #	QTY.
1	NUT, 3/8-16 HEX	101188	2
2	NUT, HEX, 5/16-18	101196	1
3	WRENCH, BOX END, 1-1/2 X 9/16	137976	1
4	HOSE, 3/8 X 5/8 VINYL, 36"	150845	1
5	WASHER, 3/8 SAE FLAT	150923	2
6	WASHER, LOCK, SPLIT, 3/8	150925	2
7	WASHER, FENDER, 5/16 X 1.0	151053	2
8	CLAMP, HOSE, 5/8	151198	2
9	SCREW, HEX HEAD, 5/16-18 X 1	151743	1
10	NUT, HEX, 1/4-20	151893	2
11	WASHER, FLAT, SAE, 1/4	151915	4
12	WASHER, LOCK, SPLIT, 1/4	152591	2
13	SCREW, HEX HD, TAP, 1/4-20X1	152676	2
14	SCREW, HEX, 3/8-16 X 3/4	153527	2
15	CABLE, 4GA X 48 RED BATTERY	153848	1
16	BOX, BATTERY	156634	1
17	TAG, SERIAL NUMBER, BLANK	157500-RW	1
18	STRAP, NYLON, 1"	158094	1
19	BATTERY, 12V, 35AH	162589	1
20	SPRING, EXTENSION, 7/16OD X 10.3L X .041WIRE	162627	1
21	WRENCH, 1" OPEN END	162656	1
22	CABLE, 44" DEPTH INDICATOR	162724	1
23	LABEL, PANEL, LOGO, RH	162725	1
24	LABEL, PANEL, LOGO, LH	162725	1
25	COVER, 1" BATTERY TERMINAL, RED	162769	1
26	FITTING, 3/4 X 11.5 FNH X 3/8 BARB	163991	1
27	WIRE HARNESS, 3000K	166638	1
28	CABLE, BATTERY, BLACK, 4GA 36"	167289	1
29	WIRE HARNESS, RAISE/LOWER	168009	1
30	FUSE, 50A MAXI BLADE	168970	1
31	TAG, EVAP, 30S, PARENT	169945-30S	1
32	RING, RETAINING, 5/16 SHAFT	171878	3
33	CASTING, MK LOGO, 3IN. COMP	172227	1

FIGURE 11 - PARTS LIST: MK-3000K CONCRETE SAW PARENT D - P/N 166449



ITEM NO.	DESCRIPTION	PART #	QTY.
1	SCREW, 3/8-16 X 1-1/4 HEX HEAD CAP	150774	2
2	GRIP, HANDLE, 1.0 ID	150842	2
3	WASHER, 3/8 SAE FLAT	150923	4
4	WASHER, 1/2 SAE FLAT	150924	4
5	NUT, WING, 5/16-18 NYLOK	151746	4
6	NUT, 3/8-16 NYLOK HEX	152505	2
7	WASHER, 1/2 SPLIT LOCK	153524	4
8	SCREW, 1/2-13 X 1-3/4 HEX HEAD CAP	153853	4
9	SCREW, FLAT HD 10-24 X 5/8	154295	2
10	HANDLEBAR	161158	2
11	KNOB, 1/2-13 T-HANDLE	162635	2
12	ASSY, POINTER	162732	1
13	ASSY, REAR POINTER	163824	1
14	ASSY, CABLE, POINTER, 90"	165739-1	1
15	CLEAT, 1/8" CABLE	165740	1
16	ASSY, SHAFT GUARD	166056	1
17	PANEL, TOWER LOWER BACK	166354	1
18	BAIL, LIFTING	169089	1

FIGURE 12 - PARTS LIST: MK-3020K CONCRETE SAW - P/N 166449-20

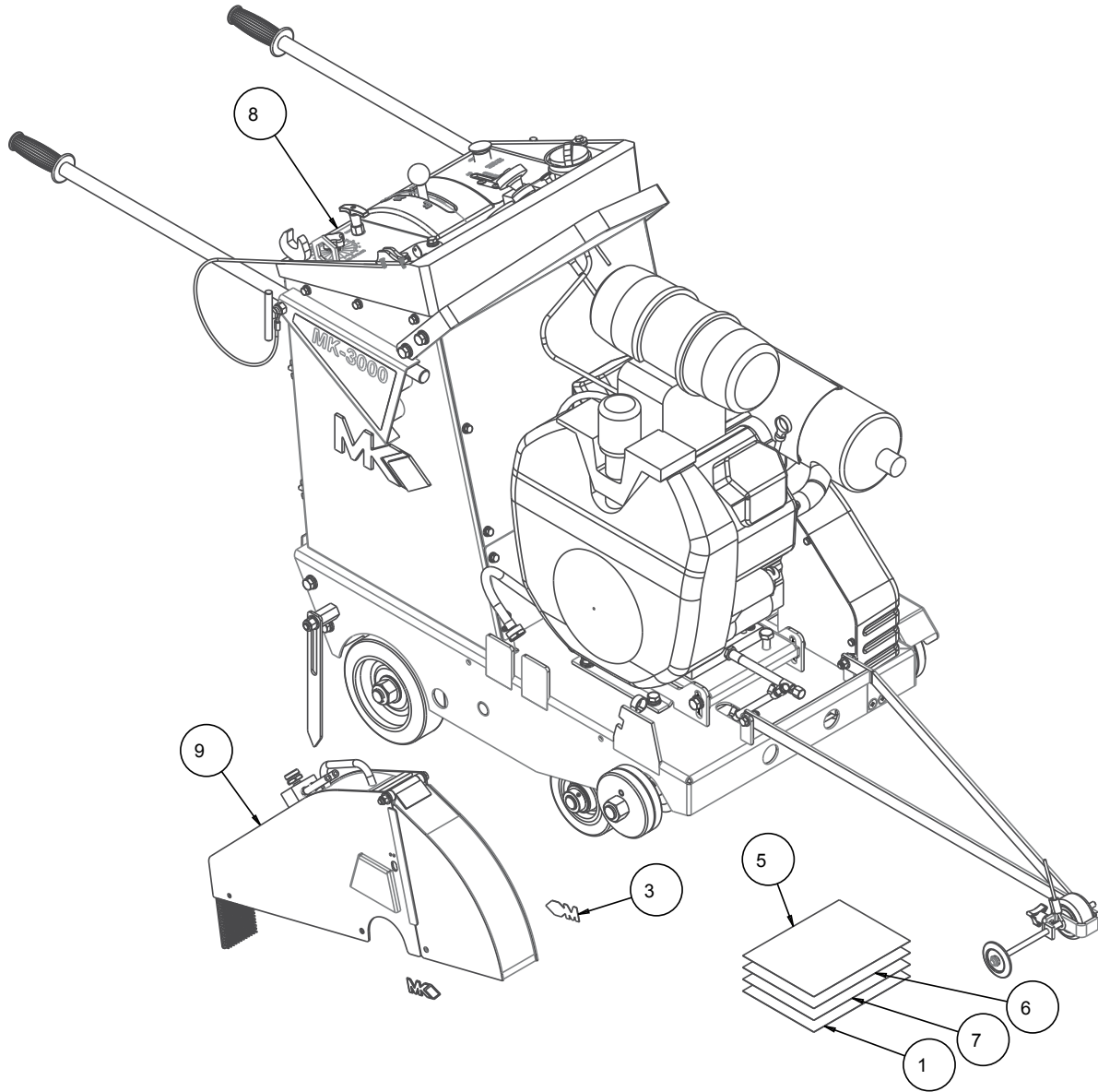

ITEM NO.	DESCRIPTION	PART #	QTY.
1	CARD, WARRANTY REGISTER SAW	155037	1
2	MANUAL TUBE, CLEAR	155419	1
3	LOGO, MK ADHESIVE	157914	2
4	PALLET, 4000	162658	1
5	ASSY, WARNING LABELS, CONCRETE	166009	1
6	OWNER'S MANUAL, MK-3000 SERIES	166447-OM	1
7	PARTS MANUAL, MK-3000 SERIES	166447-PM	1
8	MK-3000K CONC SAW PARENT	166449	1
9	ASSY, BLADE GUARD 20"	170173-20	1

FIGURE 15 - PARTS LIST: ASSY, 20" BLADE GUARD - P/N 170173-20

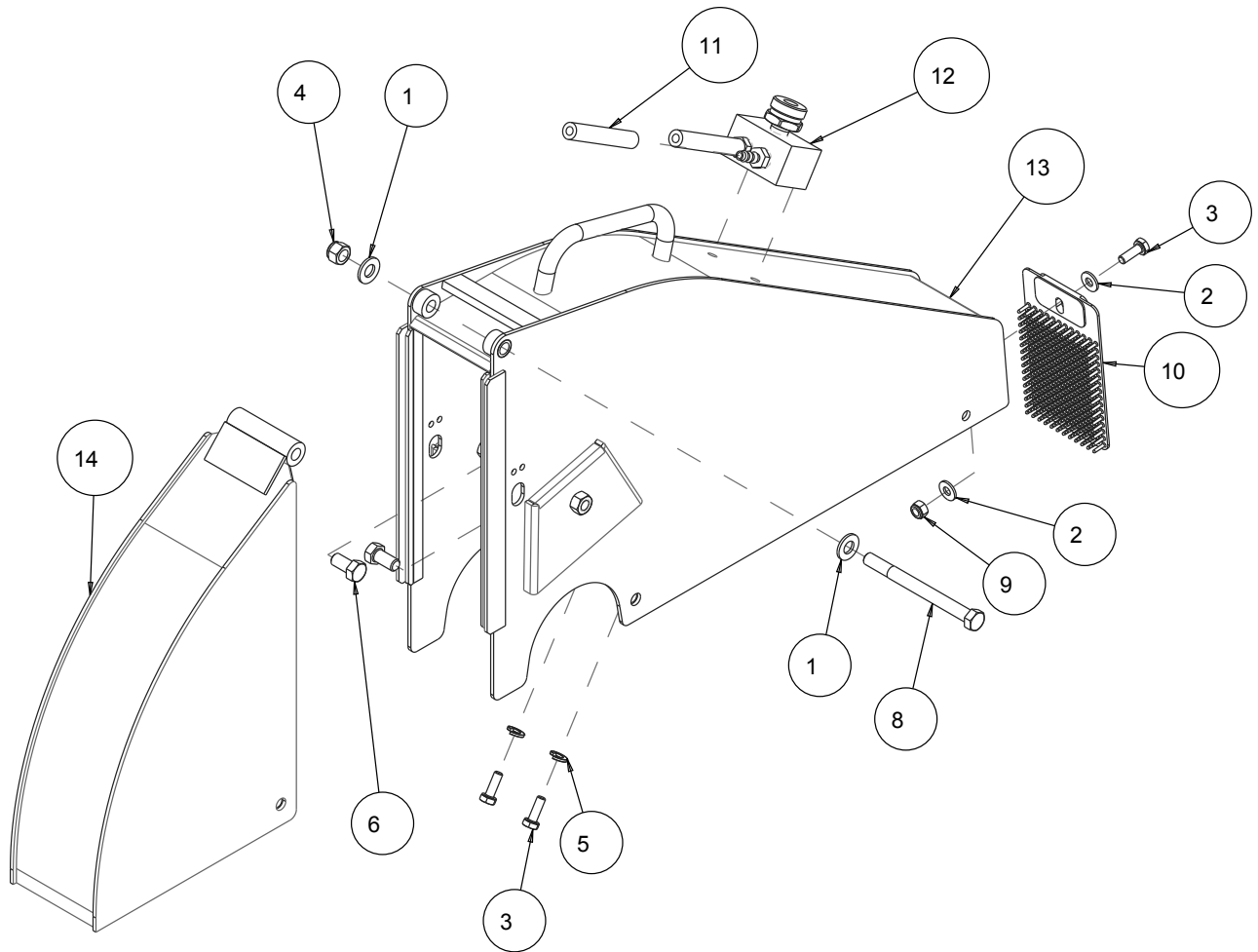
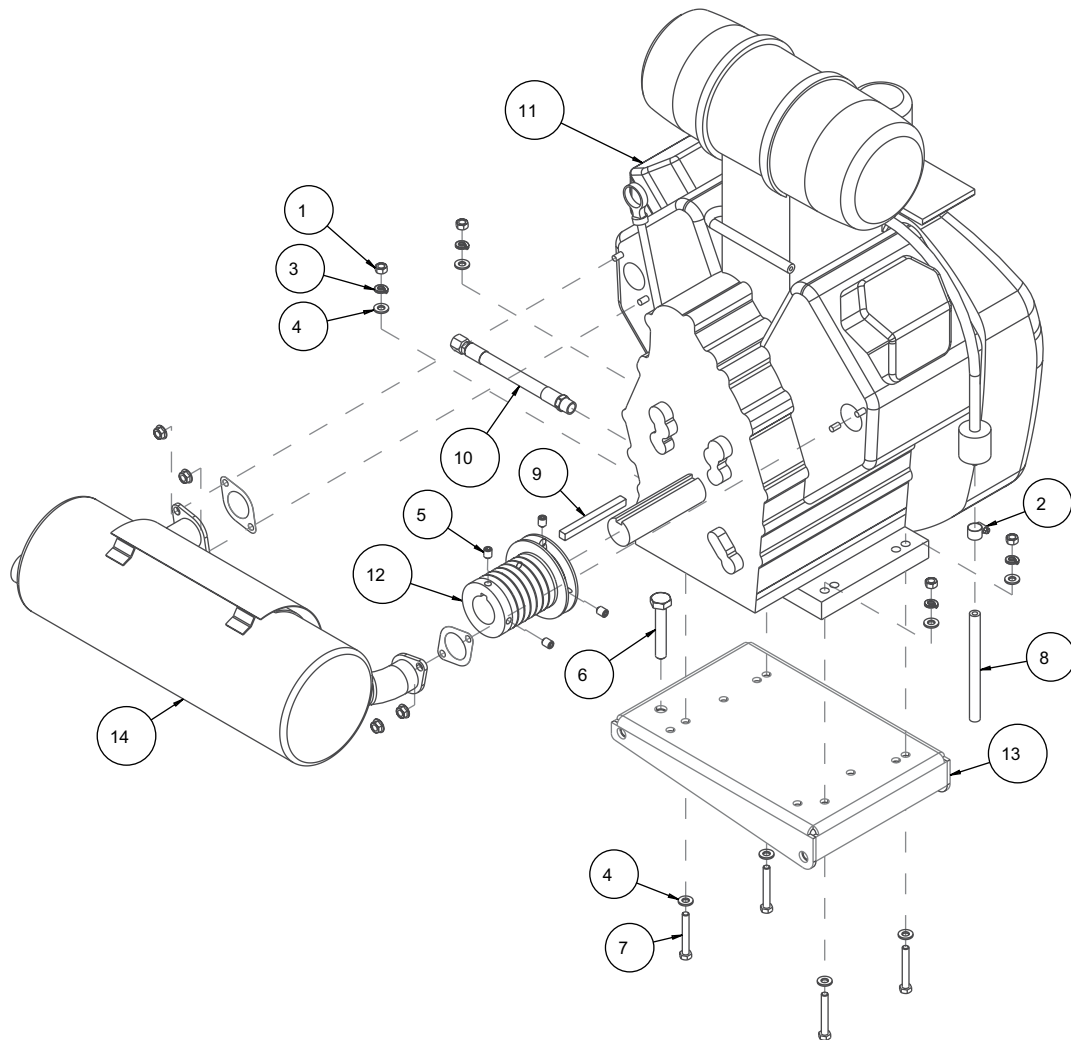

FIGURE 15 - PARTS LIST: ASSY, 20" BLADE GUARD - P/N 170173-20

ITEM NO.	DESCRIPTION	PART #	QTY.
1	WASHER, FLAT, SAE, 3/8	150923	2
2	WASHER, FLAT, SAE, 1/4	151915	2
3	SCREW, HEX HD, 1/4-20X3/4	152370	3
4	NUT, HEX, NYLK, 3/8-16	152505	1
5	WASHER, 1/4 SPLIT LOCK	152591	2
6	SCREW, HEX, 3/8-16 x 3/4	153527	2
7	TIE, NYLON CABLE, 1/8 X 4, BLACK	158528	4
8	SCREW, HEX HD, 3/8-16X4-1/4	158604	1
9	NUT, HEX NYLOK, 1/4-20	159857	1
10	GUARD, SPLASH	160310	1
11	HOSE, VINYL, 1/4 X 1/2 (24"L)	167620	2
12	ASSY, WATER MANIFOLD, 2T	167624	1
13	GUARD, BLD, 20" REAR	170171-20	1
14	GUARD, BLD, 20" FRONT	170172-20	1

FIGURE 19 - PARTS LIST: ASSY, ENGINE, 3000K - P/N 162738



ITEM NO.	DESCRIPTION	PART #	QTY.
1	NUT, HEX, 5/16-18	101196	4
2	CLAMP, 5/8 HOSE	151198	1
3	WASHER, LOCK, SPLIT, 5/16	151747	4
4	WASHER, FLAT, SAE, 5/16	151754	8
5	SCREW, SET, SOC, CUPT, 3/8-16 X 1/2	153710	4
6	SCREW, HEX HD, TAP, 1/2-13X3	153854	1
7	SCREW, HEX, 5/16-18 X 2-1/4	153951	4
8	HOSE, 1/4 FUEL, 24"	154163	1
9	KEY, SQR, 3/8 x 4.0	154853	1
10	HOSE, OIL DRAIN, 3/8MNPT	157577-05	1
11	ENGINE, KOHLER CH980	162745	1
12	PULLEY, 7/3VX/2.8 X 1-7/16 BORE	165694	1
13	MOUNT, ENGINE	166348	1
14	MUFFLER, KOHLER CH980	166636	1

FIGURE 21 - PARTS LIST: ASSY, CONTROL PANEL, 3000K - P/N 166700

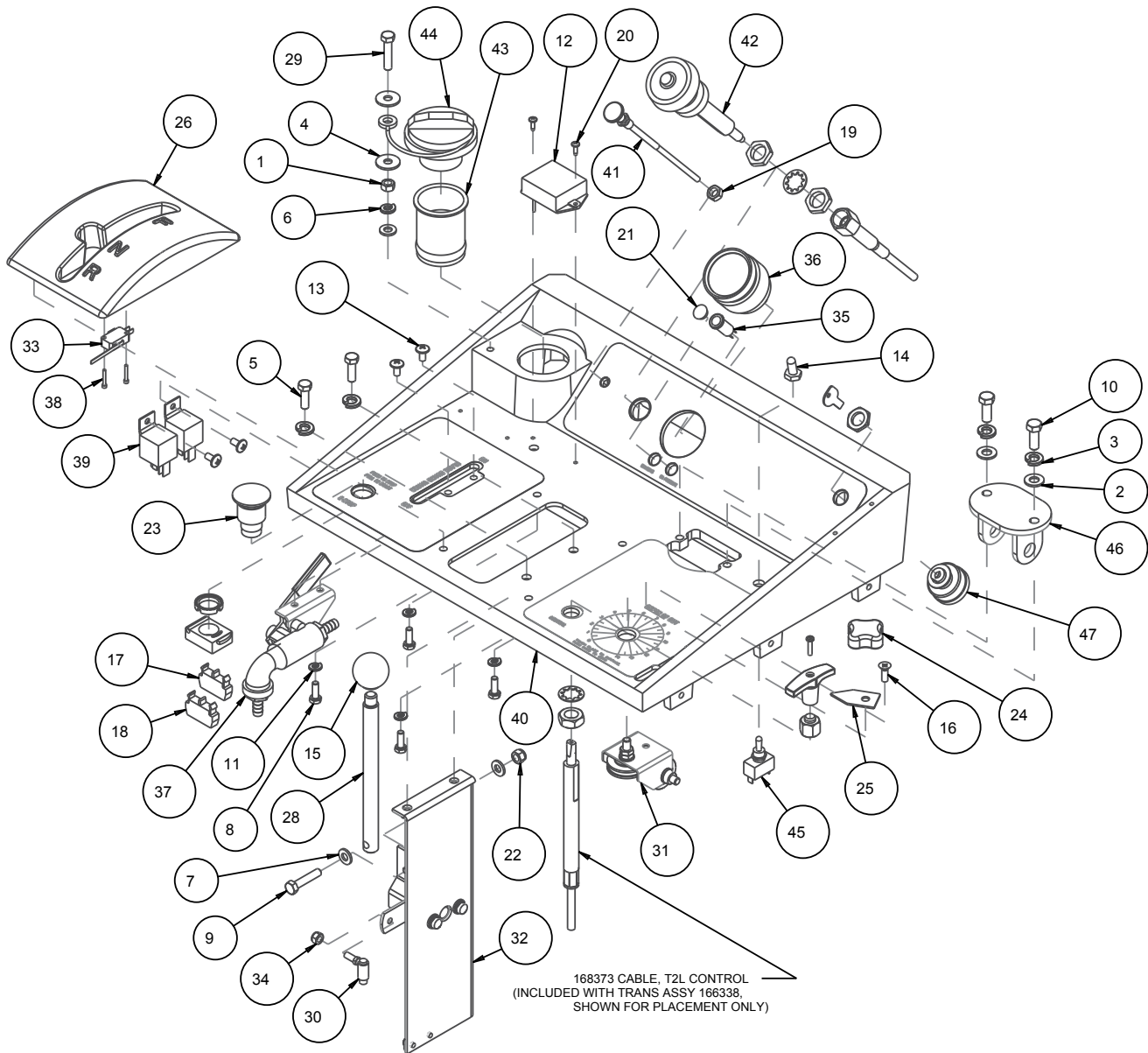

ITEM NO.	DESCRIPTION	PART #	QTY.
1	NUT, HEX, 5/16-18	101196	1
2	WASHER, 3/8 SAE FLAT	150923	2
3	WASHER, 3/8 SPLIT LOCK	150925	4
4	WASHER, FENDER, 5/16 X 1.0	151053	2
5	SCREW, HEX HD 5/16-18 X 1	151743	2
6	WASHER, LOCK, SPLIT, 5/16	151747	1
7	WASHER, FLAT, SAE, 5/16	151754	3

FIGURE 21 - PARTS LIST: ASSY, CONTROL PANEL, 3000K - P/N 166700

ITEM NO.	DESCRIPTION	PART #	QTY.
8	SCREW, HEX HD 1/4-20 X 3/4	152370	4
9	SCREW, 5/16-18 X 1-1/2 HEX HEAD MACHINE	152467	1
10	SCREW, HEX HD CAP, 3/8 - 16 X 1	152507	2
11	WASHER, 1/4 SPLIT LOCK	152591	4
12	TACHOMETER/HOURMETER	153877	1
13	SCREW, 1/4-20 X 1/2 TRUSS HEAD	153880	4
14	COVER, SWITCH	154301	1
15	KNOB, 1/2-20 FEM BALL	154486	1
16	SCREW, 1/4-20 X 3/4 FLAT HEAD	154657	1
17	CONTACTS, NO	156202	1
18	CONTACTS, NC	156204	1
19	NUT, 3/8-16 HEX	156623	1
20	SCREW, PAN HD SELF TAP 8-32 X 1/2	156632	2
21	PLUG, 1/2 FLUSH HEAD BUTTON	156779	1
22	NUT, 5/16 -18 NYLOK HEX	158289	1
23	ASSY, SWITCH BUTTON, GAS	162080	1
24	KNOB, DEPTH INDICATOR (COMP)	162629	1
25	POINTER, DEPTH INDICATOR	162630	1
26	CASTING, FNR LEVER (COMP)	162720	1
27	LABEL SHEET, CONTROL PANEL	162725	1
28	SHAFT, FNR CONTROL	162740	1
29	BOLT, 5/16-18 X 1-1/2 HEX HEAD TAP	162819	1
30	BALL JOINT, 30 SERIES	162859	1
31	ASSY, DEPTH INDICATOR	162881	1
32	ASSY, CONTROLHEAD, FNR	162882	1
33	SWITCH, 11A/120V SPDT SNAP	162887	1
34	NUT, HEX, NYLK, 1/4-28	163936	1
35	LIGHT, 1/2" DIA. PANEL, RED	163938	1
36	GAUGE, FUEL, ANALOG	164151	1
37	ASSY, WATER VALVE	164161	1
38	SCREW, 4-40 X 3/4 SOCKET HEAD CAP	164206	2
39	RELAY, 12V, 70A	164969	2
40	CASTING, CONTROL PANEL, COMP	166360	1
41	CABLE, CHOKE, 3000K (COMP)	166701	1
42	CABLE, THROTTLE, 3000K COMP	166702	1
43	NECK, 2" FUEL FILLER	167219	1
44	CAP, 2" FUEL FILLER	167220	1
45	SWITCH, TOGGLE, (ON) OFF (ON)	167224	1
46	MOUNT, UPPER, ACTUATOR	167992	1
47	SWITCH, KEYED, ON-OFF-START	171232	1

FIGURE 22 - PARTS LIST: ASSY, FRAME SUB - P/N 166326

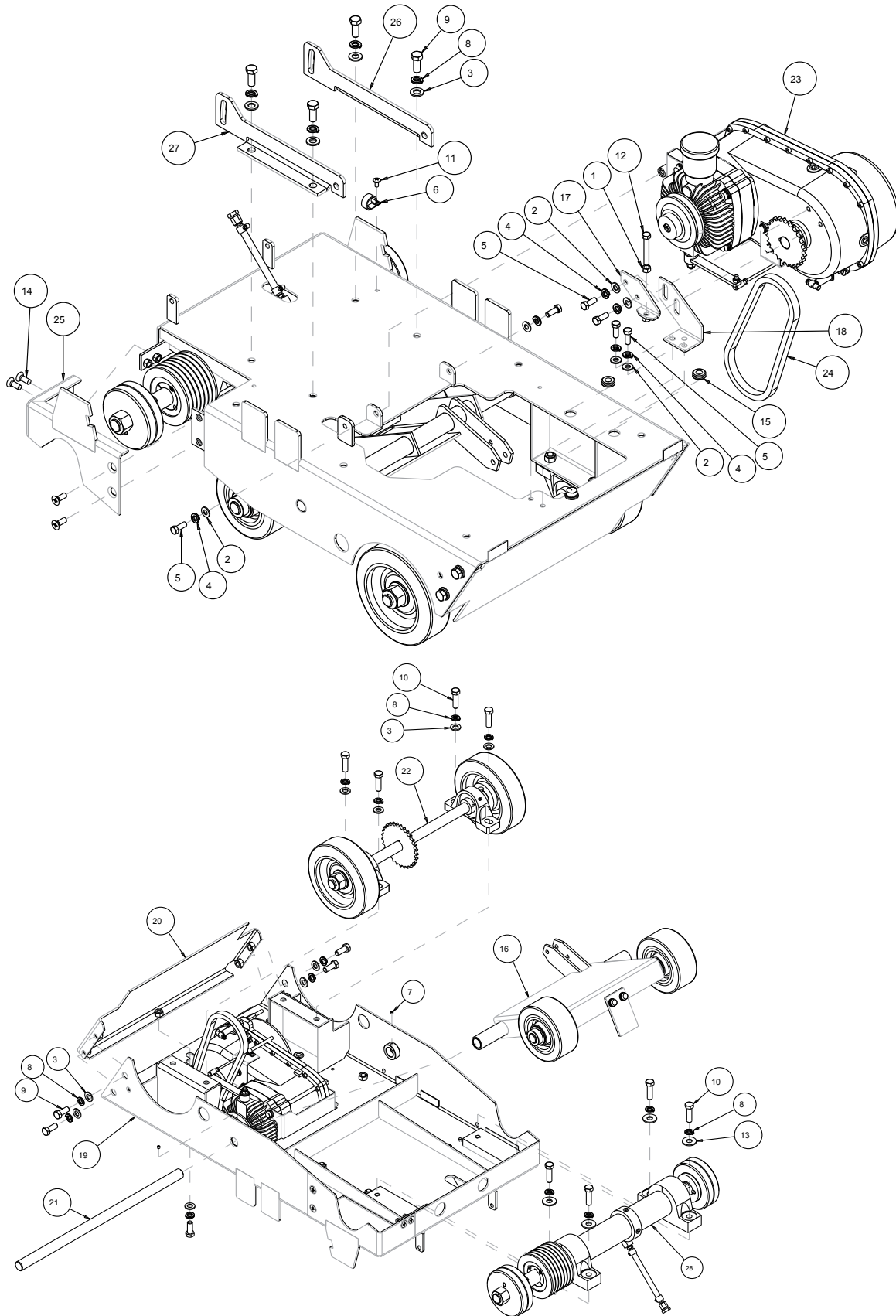
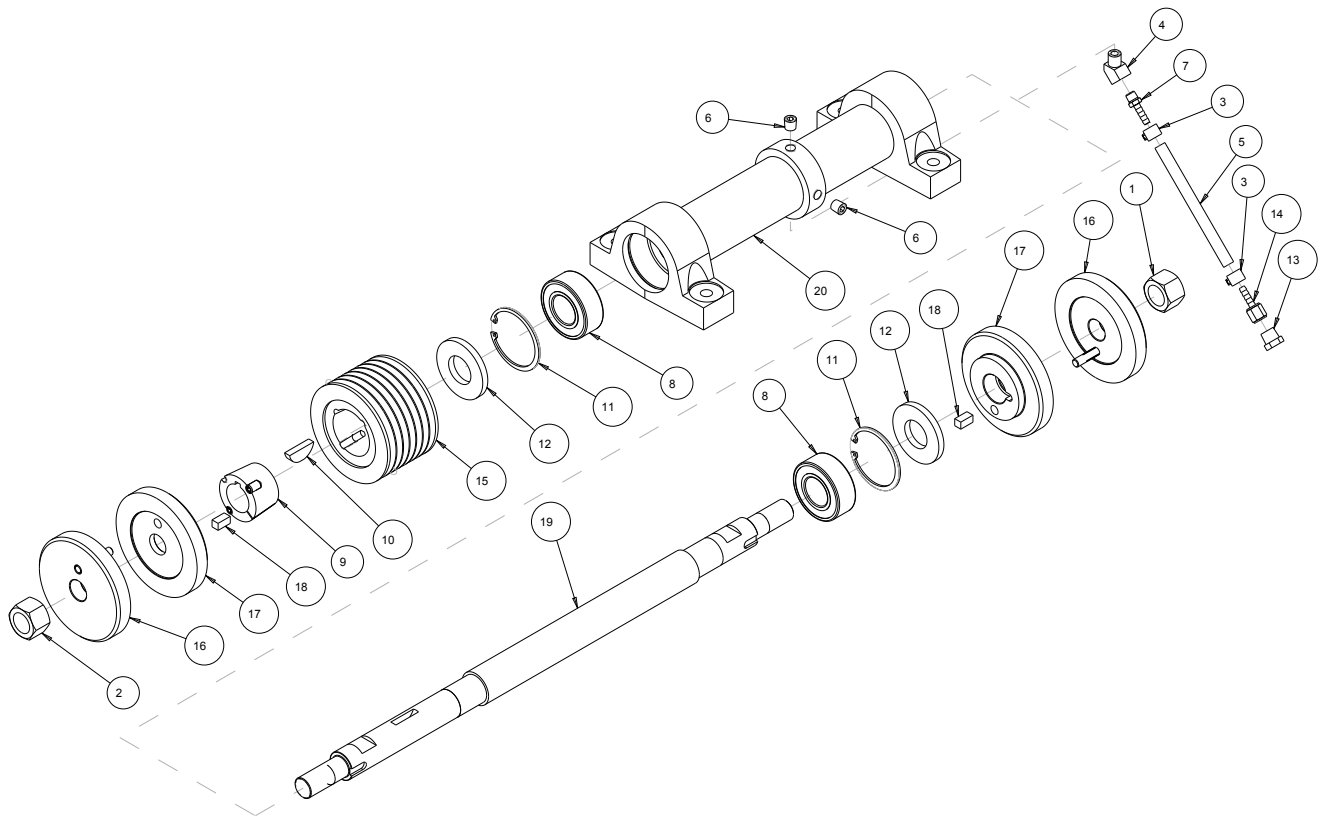

FIGURE 22 - PARTS LIST: ASSY, FRAME SUB - P/N 166326

ITEM NO.	DESCRIPTION	PART #	QTY.
1	NUT, 3/8 - 16 HEX	101188	1
2	WASHER, 3/8 SAE FLAT	150923	6
3	WASHER, 1/2 SPLIT LOCK	150924	13
4	WASHER, LOCK, SPLIT, 3/8	150925	6
5	SCREW, HEX HD CAP, 3/8 - 16 X 1	152507	6
6	CLAMP, 7/8 CUSHION LOOP	152593	1
7	SCREW, 5/16 - 18 X 1/2 SOCKET HEAD STE	152607	2
8	WASHER, 1/2 SPLIT LOCK	153524	17
9	SCREW, 1/2 - 13 X 1 - 1/4 HEX HEAD CAP	153532	9
10	SCREW, 1/2 - 13 X 1 - 1 - 3/4 HEX HEAD CAP	153853	8
11	SCREW, 1/4 - 20 X 1/2 TRUSS HEAD	153880	1
12	BOLT, 3/8 - 16 X 2 - 1/2 HEX HEAD CAP	155589	1
13	WASHER, FLAT, USS, 1/2	157679	4
14	SCREW, 3/8 - 16 X 1 FLATHEAD MACHINE	162067	4
15	GROMMET, 1/2 X 1.0	162493	2
16	ASSY, TRUCK	162742	1
17	BRACKET, TRANS LIFT, ADJ	162743	1
18	BRACKET, TRANS MOUNT FIXED	162744	1
19	FRAME, WELDMENT MAIN	166327	1
20	PLATE, REAR FRAME	166329	1
21	SHAFT, TRUCK PIVOT	166330	1
22	ASSY, AXLE, REAR	166331	1
23	ASSY, TRANSMISSION	166338	1
24	CHAIN, #40 ROLLER, W/LINK	166345	1
25	CORNER, MAIN FRAME	166350	1
26	BRACKET, ENG MOUNT, RH	169474	1
27	BRACKET, ENG MOUNT, LH	169475	1
28	ASSY, BLADE SHAFT	170034	1

FIGURE 23 - PARTS LIST: ASSY, BLADESHAFT, P/N 170034



ITEM NO.	DESCRIPTION	PART #	QTY.
1	NUT, 1 -14 RIGHT HAND	138693	1
2	NUT, 1 - 14 LEFT HAND	138701	1
3	CLAMP, HOSE, 5.8	151198	2
4	ELBOW, 1/4 NPT X 45 STREET	153869	1
5	HOSE, 1/4 FUEL, 6"	154163	1
6	PLUG, 1/4NPT HEX SOCKET	154679	2
7	FITTING, 1/8 MNPT X 1/4 BARB	155809	1
8	BEARING, 35 X 72 X 27, D-ROW BALL	160810	2
9	BUSING, TPR-LOCK, 1615 X 1 - 3/8	160811	1
10	KEY, WOODRUFF, 5/16 X 1 -1/2	160816	1
11	RING, RETAINING, 72MM INTERNAL	161201	2
12	SEAL, OIL, 1 - 3/8 X 72MM	161202	2
13	PLUG, 3/8NPT BRONZE BREATHER	161209	1
14	FITTING, 1/4 FNPT X 1/4 BARB	162601	1
15	PULLEY, 7/3V X 4.75 X 1615TB	165696	1
16	FLANGE, KEYED, INNER, 5"	168598-5	2
17	FLANGE, KEYED, INNER, 5"	168598-5	2
18	KEY, SQR, 3/8 X 3/4	169371	2
19	SHAFT, BLADE, ENCL. 300	170031	1
20	CASTING, SHAFT HOUSING, 3000-COMP	170033	1

FIGURE 24 - PARTS LIST: ASSY, TRUCK - P/N 162742

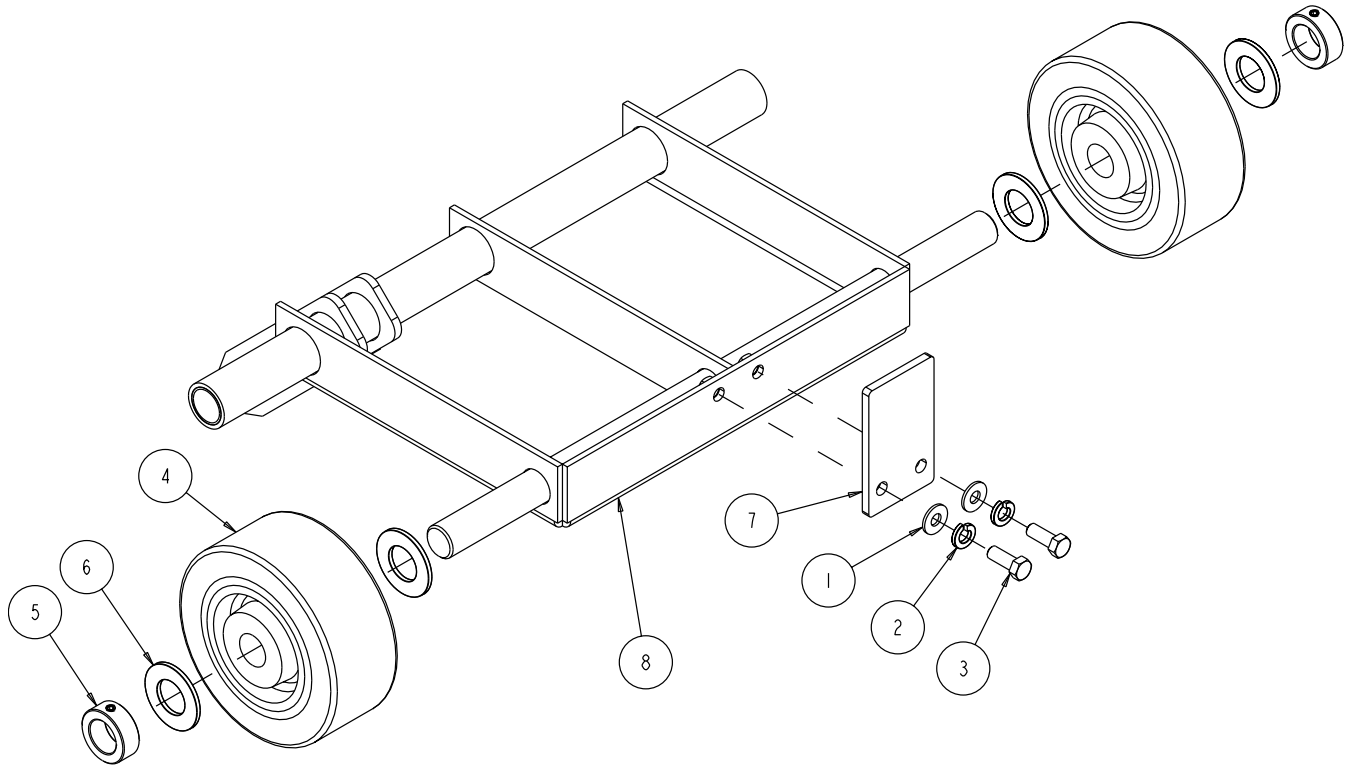

ITEM NO.	DESCRIPTION	PART #	QTY.
1	WASHER, 3/8 SAE FLAT	150923	2
2	WASHER, 3/8 SPLIT LOCK	150925	2
3	SCREW, HEX HD CAP, 3/8-16 X 1	152507	2
4	WHEEL, 6 X 2-1/2 X 1	160848	2
5	COLLAR, 1.0 SHAFT	160849	2
6	WASHER, 1 SAE FLAT	160851	4
7	STOP, TRUCK	162736	1
8	TRUCK	166328	1

FIGURE 25 - PARTS LIST: ASSY, TRANSMISSION - P/N 166338

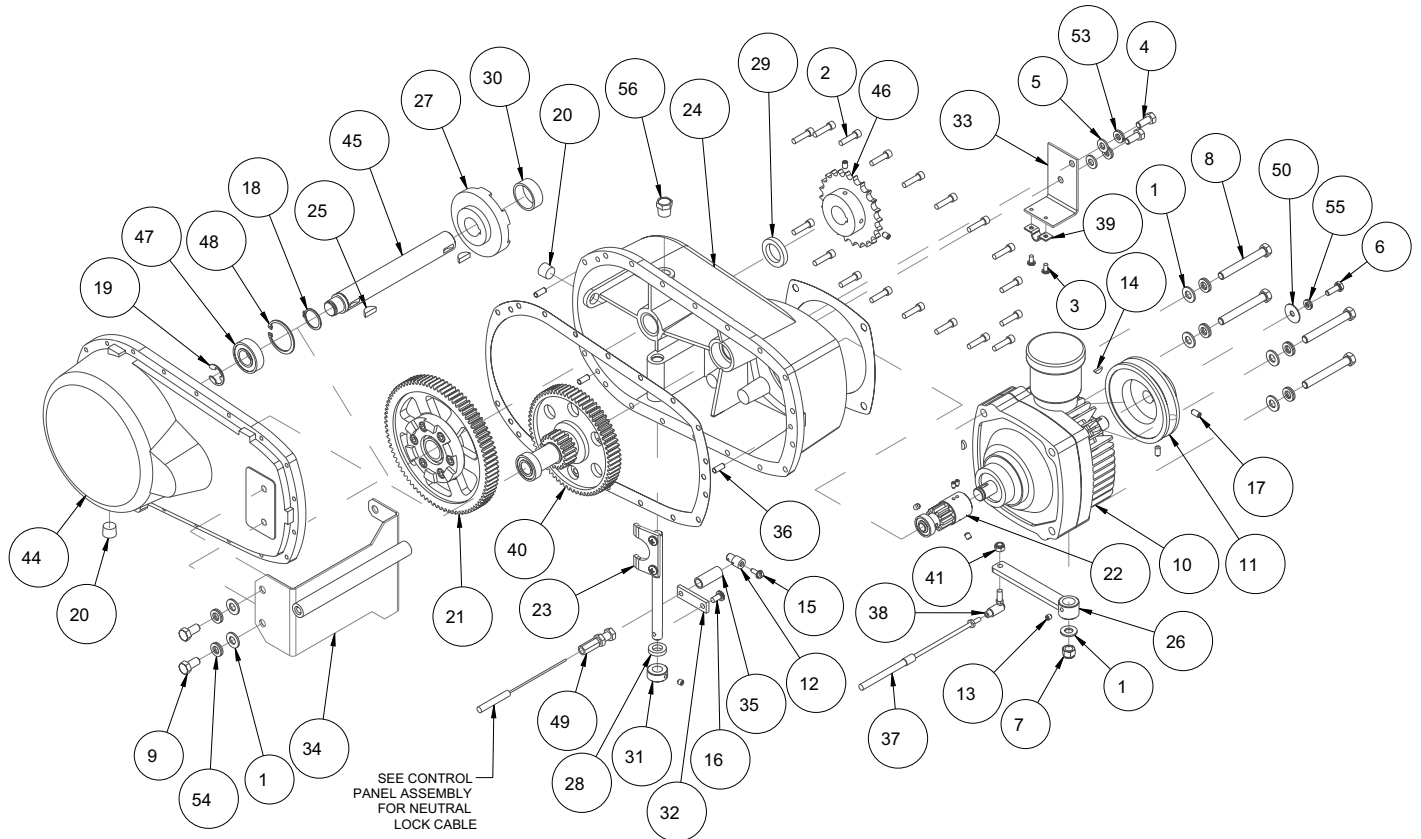

ITEM NO.	DESCRIPTION	PART #	QTY.
1	WASHER, 3/8 SAE FLAT	150923	7
2	SCREW, SOC HD CAP, 1/4-20 X 1	151049	18
3	SCREW, PAN HD, #10-24 X 3/8	151097	2
4	SCREW, HEX HD, CAP, 5/16-18 X 3/4	151369	2
5	WASHER, FLAT, SAE, 5/16	151754	2
6	SCREW, HEX HD, 1/4-20 X 3/4	152370	1
7	NUT, 3/8-16 NYLOK HEX	152505	1
8	SCREW, 3/8-16 X 3 HEX HEAD CAP	153113	4
9	SCREW, HEX, 3/8-16 X 3/4	153527	2
10	PUMP, TRANSMISSION	153783	1
11	PULLEY, A4.0 X 17 MM BORE OFFSET	153826	1
12	PIN, WIRE STOP	153842	1
13	SCREW, SET CUP PT 1/4-20 X 1/4	153864	1
14	KEY, WOODRUFF, 1/8 X 1/2	153865	2
15	SCREW, HEX HD FL 10-24 X 5/16	154172	1

FIGURE 25 - PARTS LIST: ASSY, TRANSMISSION - P/N 166338

ITEM NO.	DESCRIPTION	PART #	QTY.
16	SCREW, PAN HD, CAP, 1/4-20 X 1/2	155452	1
17	SCREW, 1/4-20 X 1/2 SOCKET HEAD SET	155804	2
18	RING, 1" EXTERNAL RETAINING	161140	1
19	RING, .75 E-STYLE RETAINING	161163	1
20	PLUG, 3/8 NPT HEX SOCKET, GALV	161208	2
21	ASSY, ENGAGEMENT GEAR	161233	1
22	ASSY, PUMP PINION	161235	1
23	ASSY, TRANS FORK 1	161237	1
24	ASSY, TRANS CASE 1	161248	1
25	KEY, WOODRUFF, 1/4 X 3/4	161261	2
26	LEVER, TRANS CONTROL	161263	1
27	PLATE, LOCKER, KEYED	161264	1
28	SEAL, OIL, 1/2 X 7/8 X 3/16	161270	1
29	SEAL, 1 X 1-1/2 X 1/4 OIL	161271	1
30	SPRING, 1.5OD X 1.3 COMPRESSION	161279	1
31	COLLAR, 1/2 SHAFT	162633	1
32	LEVER, TRANS FORK	162673	1
33	BRACKET, TRANS FNR	162735	1
34	BRACKET, TRANS PIVOT	162741	1
35	SPRING, .56 OD X 1.38 COMPRESSION	162829	1
36	PIN, 1/4 X 5/8 DOWEL	162849	3
37	CABLE, TRANS CONTROL	162858	1
36	BALL JOINT, 30 SERIES	162859	1
39	CLAMP, 30 SERIES CONDUIT	162860	1
40	ASSY, CHANGE GEAR	162883	1
41	NUT, HEX, NYLK, 1/4-28	163936	1
42	OIL, 80-90 SAE GEAR	164971	1
43	SEALANT, HI-TEMP FORM-A-GASKET	164972	1
44	CASTING, TRANS CASE3 (COMP)	166340	1
45	SHAFT, AXLE, #3	166341	1
46	SPROCKET, 40BS24 X 1.0 BORE	166342	1
47	BEARING, BALL, 20 X 42 X 12MM	166343	1
48	RING, 1-11/16 INTERNAL RETAINING	166344	1
49	FITTING, THROTTLE CABLE END	169042	1
50	WASHER, FENDER, 1/4 X 1	169049	1
51	GASKET SET, TRANSMISSION	169465	1
52	SEALANT, GASKET, PT#2 (0.5 OZ)	169466	1
53	WASHER, CHROMATE, 5/16, PAIR	169690	2
54	WASHER, CHROMATE, 3/8, PAIR	169692	6
55	WASHER, CHROMATE, 1/4, PAIR	169693	1
56	PLUG, 3/8 NPT BRONZE BREATHER	170959	1

FIGURE 26 - PARTS LIST: ASSY, AXLE, REAR - P/N 166331

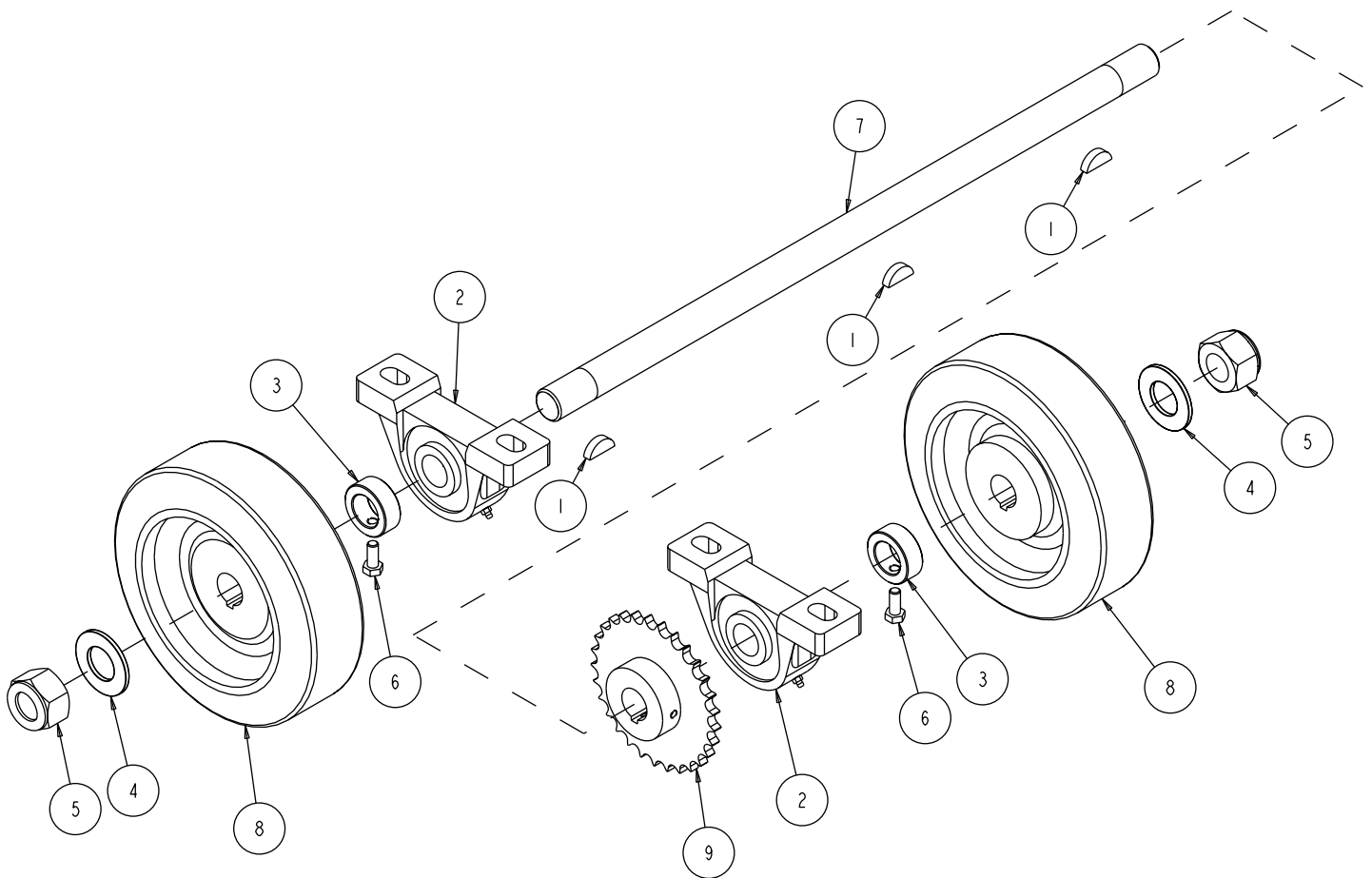

ITEM NO.	DESCRIPTION	PART #	QTY.
1	KEY, 1/4 X 1 WOODRUFF	150795	3
2	BEARING, 1.0 ID PILLOW BLOCK	157924	2
3	COLLAR, 1" SHAFT	160849	2
4	WASHER, 1 SAE FLAT	160851	2
5	NUT, 1-8 NYLOK HEX	163235	2
6	SCREW, 5/16-24 X 3/4 HEX HEAD MACHINE	165617	2
7	SHAFT, REAR AXLE	166332	1
8	WHEEL, 8 X 2-1/2 X 1.0 BORE	166333	2
9	SPROCKET, 40BS29 X 1.0 BORE	166334	1

FIGURE 27 - PARTS LIST: ASSY, FUEL TANK, GASOLINE - P/N 166357

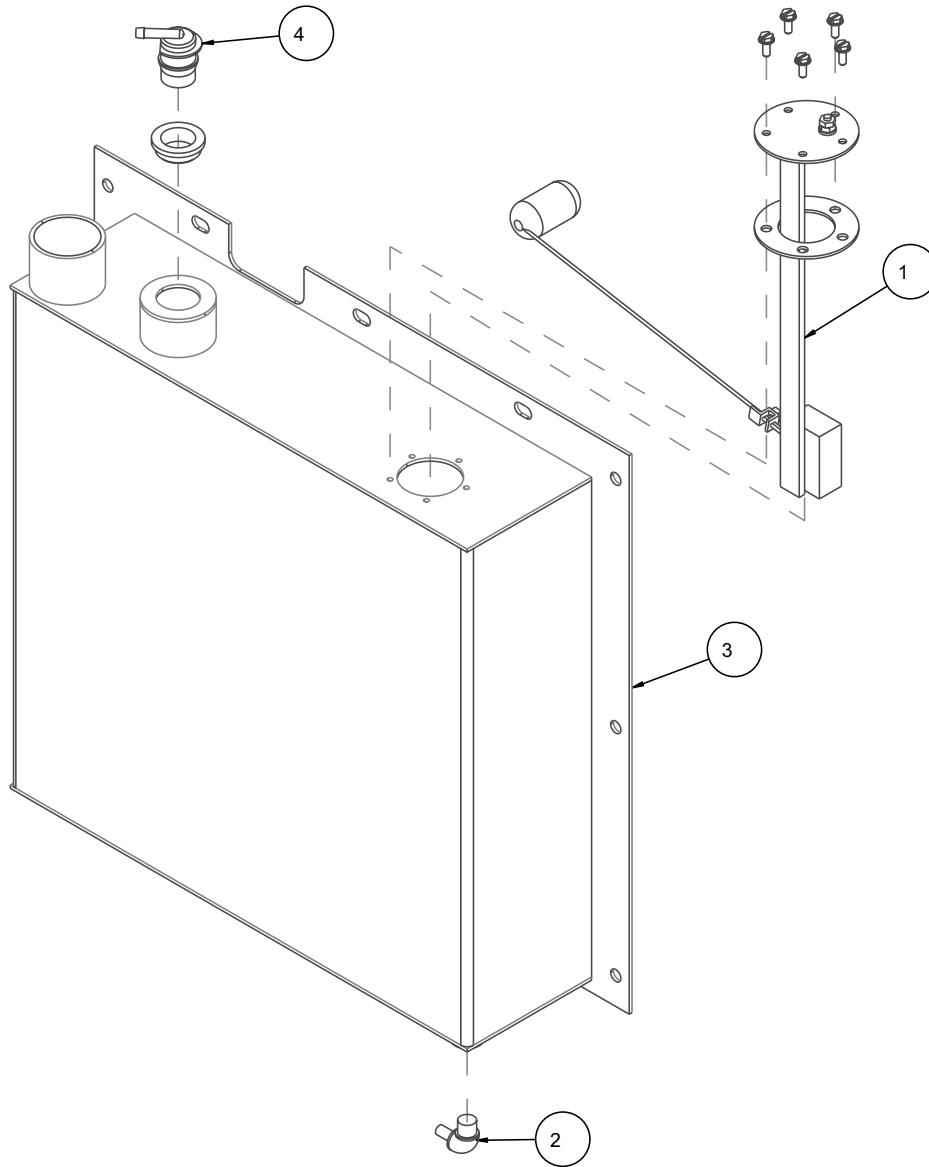

ITEM NO.	DESCRIPTION	PART #	QTY.
1	SENDER, FUEL	162636	1
2	ELBOW, 1/4 MNPT X 1/4 BARB, 90 DEG	162637	1
3	TANK, FUEL	166358	1
4	VALVE, ROLL OVER VENT	169772	1

FIGURE 28 - PARTS LIST: ASSY, POINTER - P/N 162732

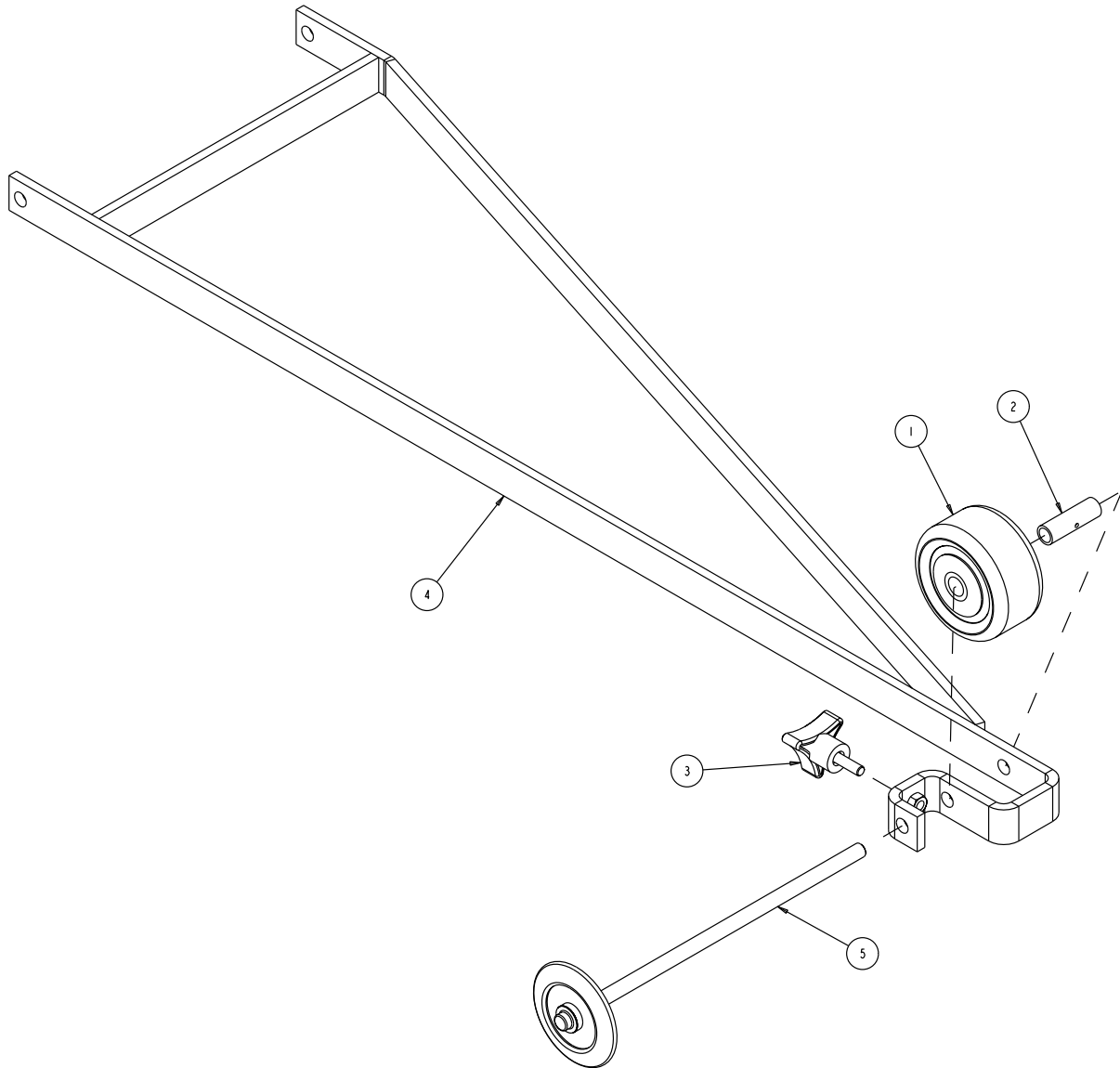

ITEM NO.	DESCRIPTION	PART #	QTY.
1	WHEEL, POINTER, 3"	155066	1
2	BUSHING, 3/8 ID X 1-5/8L	155153	1
3	KNOB, 1/4-20 3/4 PRONG, NO LOGO	160482	1
4	ARM, POINTER	162733	1
5	ASSY, POINTER WHEEL	165238	1

FIGURE 29 - PARTS LIST: ASSY, SHAFT GUARD - P/N 166056

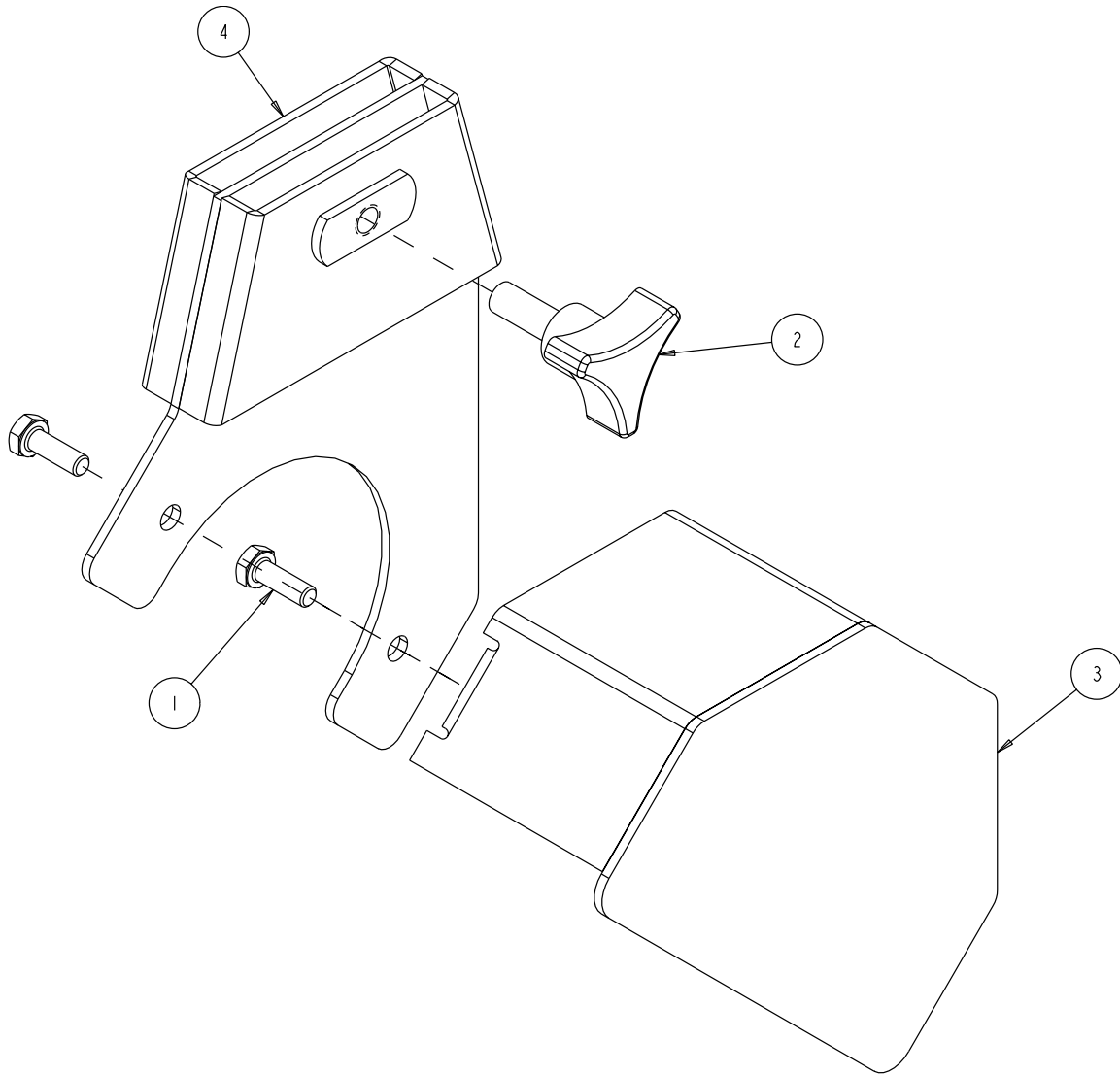

ITEM NO.	DESCRIPTION	PART #	QTY.
1	SCREW, HEX HD 1/4-20 X 3/8	153526	2
2	KNOB, 3 PRONG 3/8-16 X 1	156175	1
3	GUARD, SHAFT	161109	1
4	BACK PLATE, SHAFT GUARD	166057	1