



Rodamientos de rodillos cilíndricos  
Cylindrical roller bearings



## The company

---

NBI is a **Premium brand** serving the market since 2002.

Key positions are covered by professionals with vast experience in the bearing industry. The main features of NBI Bearings Europe to be highlighted are:

Commercial capacity:

- Focused on supplying bearings for high technical requirement applications to OEM customers. A large list of leading OEM clients' referrals backs NBI's reputation.
- Sales and customer service teams, formed by more than 25 people providing a personalized service, are located in Spain, China, Romania, Brazil and India.
- Romania-based highly experienced application engineering team that provides the best pre-sales & after-sales technical assistance.
- Distribution centers for on-time deliveries in Spain, China and India.

Technical expertise:

- Own design and R&D teams in Spain that have supported the development of a new proprietary design software. Product portfolio that covers CRB, SRB, TRB, CRTB, SPB and CF. NBI is continuously adding new items to its Enhanced bearing line.
- Manufacturing plants in Spain, China and India.
- Fully equipped metrology, metallographic and other tests laboratories.

Financial position:

- Solid financial health thanks to a robust cash position.
- Publicly listed in the MAB (Spanish stock exchange market for small and medium sized companies) since 2015 with stable core shareholders.

# Vision

---

Develop a solid group of companies focused on the design, manufacturing and marketing of precision bearings and high value-added technical products that are especially aimed at industrial sectors.

With a value proposition recognized by our clients and supported by the following pillars:

- **Extraordinary customer service.** Fulfill our quality commitments and delivery deadlines with close attention.
- **Continuous innovation** focused on own product design.
- **Pre-sales & after-sales technical service** as a differentiating element.
- **Supply chain** based on close and long-term relationships and mutual trust.
- **Operational excellence** focused on doing more with less.

Focused on achieving:

- **Satisfaction of our clients** Gain their trust and loyalty through multi-year agreements, and consequently achieve a *win-win* relationship.
- **Persons** committed and proud of working at NBI. **Own Culture and Values.**
- **Satisfied shareholders.** Generating sustainable profitability in the medium-term always with absolute transparency.



## NBI in the word



### Bearings business unit

#### NBI BEARINGS EUROPE

NBI headquarter, R&D, designing, manufacturing plant, warehouse and sales office in Oquendo (Spain).

#### NBI INDIA

Manufacturing plant and warehouse in Ahmedabad and sales office in Kolkata (India).

#### NBI BEARINGS ROMANIA

Application engineering and sales office in Bucharest (Romania).

#### NBI BEARINGS DO BRAZIL

Sales office in Sorocoba (Brazil).

#### CRONOS

Manufacturing plant warehouse and sales office.

### Metal transformation business unit

#### EGIKOR

Technical office and metal stamping plant in Ermua (Spain).

#### AIDA INGENIERÍA

Technical office and boiler-making plant in Artea (Spain).



### Precision machining business unit

#### INDUSTRIAS METALÚRGICAS GALINDO

Technical office and precision machining plant in Mungía (Spain).

#### TALLERES ERMUA

Technical office and precision machining plant in Mallabia (Spain).

#### INDUSTRIAS BETICO

Technical office and multi-spindle machining plant in Bergara (Spain).

# NBI Enhanced bearings line

## ENHANCED+: new bearing line

NBI has developed a proprietary software,  to design CRB, SRB and TRB series.

NBI combines experience in designing and producing bearings with the latest technology in material research and manufacturing technology to create a new bearing line with superior benefits:

- Improved dynamic load capacity and consequently, longer operating time.
- Reduced friction and lower operating temperature.
- Downsizing possibility
- Lower overall costs.

Main improvements:

- Higher steel purity and adjusted composition according to the ring thickness and roller section.
- Optimized microstructure: Aichelin roller hearth salt bath furnace.
- Optimized surfaces and internal design.



Cylindrical Roller Bearing (CRB)



Spherical Roller Bearing (SRB)



Taper Roller Bearing (TRB)



Cylindrical Roller Thrust Bearing (CRTB)



Spherical Plain Bearing (SPB)

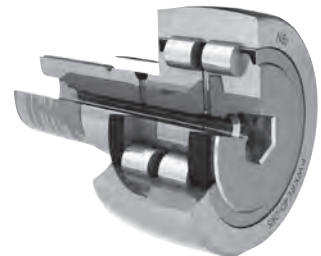

Cam Follower (CF)

## Advanced calculation capabilities

NBI's application engineering team provides each client with the best technical advice whatever the situation:

- For new applications under development.
- For changes in the parameters of the operational regime of the machines.
- For solving repetitive bearing damages in specific positions within a client's applications.
- For a better understanding on how certain environmental factors influence the bearings performance.

## FOR GEARBOXES, DRIVELINES AND VARIOUS OTHER APPLICATIONS



### Innovative solutions

Strategic partnership with Romax. Working very closely with the development team of Romax to improve and add new features. Currently, NBI has 6 licenses.

Using state-of-the-art computer analysis tools, NBI is capable of running accurate computer simulations of customer's application and perform a complex analysis of the bearing system.

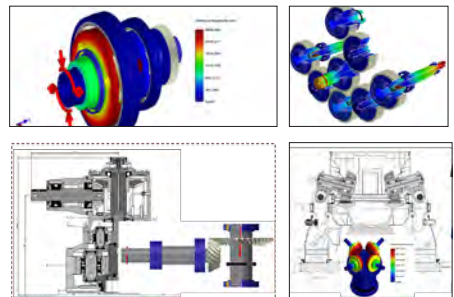

NBI's  
PROPRIETARY  
SOFTWARE



## ADVANCED BEARING-ROPE SHEAVES CALCULATION SYSTEM

Considering design & operational factors, such as sheave material & geometry, rope load, wrap and fleet angles and working temperature.

### NBI can calculate

Lifetime rating based on ISO/TS 16281.

Static safety factor based on loads and contact stress.

Operating radial clearance due to the interference produced by bearing with sheave and bushing.

Contact stress between bearing and sheave.



## FINITE ELEMENT ANALYSIS

### Advanced modelling and simulation

Calculations account for the impact of all operating conditions, bearings micro-geometry, and environmental factors such as non asymmetric housings or shafts or other flexible components, for the most accurate results.

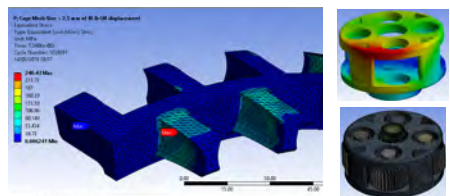

# Laboratories

In-house metallographic, metrology and other tests laboratories equipped with the latest technology. Strategic partnership with some of the most advanced Spanish technological centers: CEIT IK4 and Tekniker IK4. These fully equipped laboratories are shared by the application engineering, design, R&D and manufacturing teams.



## Metrology laboratory

- Conditioned quality room equipped with temperature and humidity control systems.
- ZEISS coordinate measurement machine 3D for rings, cages, rolling elements and models.
- Taylor Hobson roundness testers for small and large rings as well as for harmonics.
- Taylor Hobson profilometer-roughness testers for small and large bearings.
- Optical comparator to measure contour form.
- Trimos high precision calibration system for creating own masterpieces and in-house calibration of measurement devices.

## Metallographic laboratory

- Spectrometer and elementary inorganic analyzers LECO for raw material composition.
- Inverted optical brightfield microscope for the measurement of non-metallic inclusion carbides, grain size and microstructure.
- Hardness tester for HRB, HRC & HV.
- Scanning electron microscope for fracture & substructure analysis.
- Focus Ion Beam (FIB) equipment for material structure, composition & layer thickness analysis.
- X-ray fluorescence measuring system for zinc coating thickness measurement.
- Magnetic particle test bench for detecting superficial and sub-superficial cracks.
- Submerged ultrasonic bearing automatic inspection for internal defects.
- Nital etching for grinding burns inspection.
- X-ray diffractometer for the detection of stresses and retained austenite content.
- Dilatometer for thermal stabilization & simulation of heat treatments.

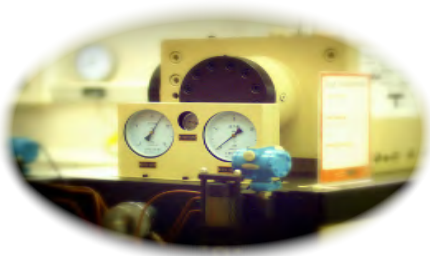

## Other tests laboratory



- Accelerated bearing life testers for small and medium sizes.
- Equipment to measure and evaluate capacities and behavior of different sealing systems for bearings.
- Tailor-made machine to test adherence between fabric and steel.
- Salt fog chamber for evaluating different advanced anti-corrosion coatings performance.
- Virtual tool for bearing performance analysis

## Manufacturing plants - Oquendo (Spain)



Investment up to now of 10 million euros. 2.500 m<sup>2</sup> surface for manufacturing (total area 5.500 m<sup>2</sup>).

Equipped with the latest European technology, that allows to achieve high-precision bearings. All processes are performed by CNC controlled equipment.

Team formed of managers and operators with many years of experience in bearing production.

In-house metallographic, metrology and other tests laboratories equipped with the latest technology.

Long-term investment plan in place with the following purposes:

- Extend the area dedicated to production.
- Increase the volume of bearing output on the already existing range (reinforcing the bottleneck capacity).
- Widen the existing range of diameter sizes and bearing types.
- Incorporate key processes in-house: heat treatment.



Manufacturing line



General view manufacturing plant



Automatic robot



### Current capacity (mm)

Inner diameter 80 ÷ 240  
Outer diameter 100 ÷ 400

### Incoming capacity (mm)

Inner diameter 240 -700  
Outer diameter 400 ÷ 1.000



## Manufacturing plants - Wujin (China)



Investment up to now 18 million euros. 15.000 m<sup>2</sup> surface for manufacturing (total area 35.000 m<sup>2</sup>).

Equipped with the latest Chinese technology, that allows to achieve high-precision bearings. All processes are performed by CNC controlled equipment. 220 grinders and 40 turning machines available. 17 small, 5 medium and 2 large bearing grinding lines. Factory is equipped with an Aichelin heat treatment line. A turning workshop is also available. Ability to design and manufacture its own grinders.

Team formed of managers and operators with many years of experience in bearing production.

In-house metallographic, metrology and other tests laboratories equipped with the latest technology.

Long-term investment plan in place with the following purposes:

- Extend the area dedicated to production.
- Increase the volume of bearing output on the already existing range (reinforcing the bottleneck capacity).
- Widen the existing range of diameter sizes and bearing types.

Certified with: IATF 16949:2016. TÜV, ISO 14001:2015. DNV and ISO 45001:2018. DNV.



Large sizes grinding line



CRB small sizes grinding line



CRB medium sizes grinding line



**Current capacity (mm)**

Inner diameter 20 ÷ 1.400

Outer diameter 30 ÷ 1.600

Specialized in CRB and TRB

## Manufacturing plants - Ahmedabad (India)



Investment up to now 3 million euros. 3.000 m<sup>2</sup> surface for manufacturing.

Equipped with the latest Indian technology, that allows to achieve high-precision bearings. All processes are performed by CNC controlled equipment.

Team formed of managers and operators with many years of experience in bearing production.

In-house metallographic, metrology and other tests laboratories equipped with the latest technology.

Long-term investment plan in place with the following purposes:

- Extend the area dedicated to production.
- Increase the volume of bearing output on the already existing range (reinforcing the bottleneck capacity).
- Widen the existing range of diameter sizes and bearing types.
- Incorporate key processes in-house: heat treatment.

Certified with: ISO 9001:2015.TÜV.



SRB grinding line



SRB grinding line



Washing line



### Current capacity (mm)

SRB-TRB

Inner diameter 40 ÷ 125  
Outer diameter 100 ÷ 200

### Incoming capacity (mm)

SRB

Inner diameter 120 ÷ 200

Outer diameter < 400





## índice

2.1 Rodamientos de una hilera de rodillos cilíndricos con jaula .....	<b>3</b>
2.2 Rodamientos de doble hilera de rodillos cilíndricos .....	<b>59</b>
2.3 Rodamientos completamente llenos de rodillos cilíndricos .....	<b>85</b>
2.4 Rodamientos de dos hileras completamente llenos de rodillos cilíndricos para poleas de cable .....	<b>125</b>
2.5 Rodamientos de rodillos cilíndricos de cuatro y seis hileras .....	<b>143</b>
2.6 Rodamientos axiales de rodillos cilíndricos .....	<b>167</b>

## index

2.1 <i>Single row cylindrical roller bearings with cage</i> .....	<b>3</b>
2.2 <i>Double row cylindrical roller bearings</i> .....	<b>59</b>
2.3 <i>Full complement cylindrical roller bearings</i> .....	<b>85</b>
2.4 <i>Double row full complement cylindrical roller bearings for cable sheaves</i> .....	<b>125</b>
2.5 <i>Four and six row cylindrical roller bearings</i> .....	<b>143</b>
2.6 <i>Cylindrical roller thrust bearings</i> .....	<b>167</b>

# Cylindrical roller bearings

# 2.1



Rodamientos de una hilera de rodillos cilíndricos con jaula  
Single row cylindrical roller bearings with cage



## 2.1 Rodamientos de una hilera de rodillos cilíndricos con jaula *Single row cylindrical roller bearings with cage*

índice	Características técnicas .....	6
	Variantes de diseño estandarizadas .....	7
	Diseño interno reforzado, sufijo E .....	8
	Rodamientos con un agujero cónico .....	9
	Desalineación .....	9
	Tolerancias .....	9
	Jaulas .....	10
	Juego radial interno .....	10
	Juego radial interno no estándar.....	11
	Temperatura de funcionamiento .....	11
	Carga mínima .....	11
	Capacidad de carga axial dinámica .....	11
	Carga dinámica equivalente.....	14
	Carga estática equivalente .....	15
	Dimensiones de los chaflanes .....	15
	Diseño de los asientos de los rodamientos como pistas de rodadura .....	17
	Designaciones complementarias .....	17
Tabla de dimensiones: N, NU .....	20	
Tabla de dimensiones: NJ, NUP, NF,...+HJ .....	40	
index	Technical characteristics .....	6
	Standard design variants .....	7
	Reinforced internal design, suffix E .....	8
	Bearings with a tapered bore .....	9
	Misalignment .....	9
	Tolerances .....	9
	Cages .....	10
	Internal radial clearance .....	10
	Non-standardized clearances .....	11
	Operating temperature .....	11
	Minimum load .....	11
	Dynamic axial load carrying capacity .....	11
	Equivalent dynamic bearing load .....	14
	Equivalent static bearing load.....	15
	Abutment and fillet dimensions.....	15
	Design of bearing seats as raceways.....	17
	Supplementary designations .....	17
Dimensions table: N, NU.....	20	
Dimensions table: NJ, NUP, NF,...+HJ .....	40	

### NBI E<sup>+</sup> - SERIES CON SUPERIORES CAPACIDADES DE CARGA

NBI ha combinado los últimos avances en investigación de materiales y en metalurgia con su experiencia en diseño y fabricación de rodamientos para crear una nueva línea de rodamientos de rodillos cilíndricos con excepcionales prestaciones.

La mejora en la rugosidad de las pistas de rodadura y la optimización de los perfiles de las mismas, junto con el empleo de rodillos de un grado de precisión superior minimizan el rozamiento y optimizan la distribución de la carga. La circulación del lubricante también se favorece con un nuevo diseño de los flancos de guiado de los rodillos en las pistas.

La capacidad de aceptar desalineamientos y la capacidad de carga axial han aumentado como consecuencia de estas mejoras. Para todas las cuestiones acerca de las series NBI E<sup>+</sup>, consulte con nuestro departamento de ingeniería.

### NBI E<sup>+</sup> - SERIES WITH ENHANCED LOAD RATING CHARACTERISTICS

NBI has combined the latest achievements of metallurgy and material research with its expertise in bearing design and manufacturing to create a new line of cylindrical roller bearings with additional benefits.

Improvements in internal design features optimize the internal load distribution. Lubricant flow is enhanced by newly defined geometry of the bearings functional surfaces.

The ability to accept misalignments plus the axial load carrying capacity have increased due to these improvements. This technical progress allows for working with higher dynamic load ratings. For all questions you may have regarding the NBI E<sup>+</sup> series, please feel free to contact our engineering team.



N



NU



NJ



NUP



NU+HJ



NJ+HJ



NF



RN



RNU





## RODAMIENTOS DE UNA HILERA DE RODILLOS CILÍNDRICOS CON jaula

### Características técnicas

Los rodamientos de una hilera de rodillos cilíndricos con jaula son rodamientos radiales y despiezables.

El montaje de estos rodamientos es sencillo debido a la posibilidad de colocar sus componentes individualmente.

Adicionalmente, esta característica técnica permite el uso de ajustes con interferencia en ambos aros, lo cual es una ventaja en aquellas aplicaciones sometidas a vibraciones o cargas de choque.

Sus dimensiones principales están estandarizadas en la normas DIN 616 Y DIN 5412 / part 1.

Dependiendo de su diseño, los rodamientos de una hilera de rodillos cilíndricos son apropiados como rodamientos libres, rodamientos de apoyo o rodamientos fijos.

Los rodamientos de rodillos cilíndricos tipo N y NU son rodamientos libres idóneos, otras variantes de diseño, como es el caso del NJ, NF, y NU+HJ pueden aceptar cargas en una dirección. Y otros como los NUP y NJ+HJ admiten cargas en las dos direcciones.

Los rodamientos de una hilera de rodillos cilíndricos son capaces de funcionar a velocidades altas en relación a otros tipos de rodamientos.

En el caso de aplicaciones en el que el espacio disponible para el rodamiento es limitado, (i.e. cajas de engranajes), los rodamientos de una hilera de rodillos cilíndricos pueden utilizarse sin su aro exterior o interior, denominándose tipo-RN o tipo-RNU, respectivamente.

## SINGLE ROW CYLINDRICAL ROLLER BEARINGS WITH CAGE

### Technical characteristics

Single row cylindrical roller bearings with cage are radial and separable bearings.

Due to the possibility of fitting the different components of the bearings, i.e. the outer and the inner rings, individually, the mounting becomes easier.

Furthermore, this technical feature allows for the use of press fits for both rings which is of advantage in applications where vibrations or shock loads occur.

Their boundary dimensions are standardized by the DIN Standards, DIN Standard 616 plans and DIN 5412 / part 1.

Depending on their design, single row cylindrical roller bearings can be used as non-locating bearings, semi-locating bearings or as locating bearings.

N and NU type cylindrical roller bearings are ideal non-locating bearings, other design variations, i.e. NJ, NF and NU+HJ designs, can also handle thrust forces up to an certain amount in one direction, and others like NJ+HJ and NUP can admit loads acting in both directions.

Single row cylindrical roller bearings feature relatively high speed ratings when compared to other roller bearing types.

In the case of bearing applications having only limited space available (i.e. gear boxes), single row cylindrical roller bearings can also be used without their respective outer or inner rings, i.e. RN-type and RNU-type bearings, respectively.

Este tipo de diseño permite que los rodillos rueden directamente sobre la superficie de contacto con el eje o con el alojamiento.

En este caso, en tales disposiciones de rodamiento, la superficie de contacto de las partes adyacentes debe estar templada y rectificada, como lo están las pistas de rodadura de los rodamientos, habitualmente.

### Variantes de diseño estandarizadas

Los rodamientos de una hilera de rodillos cilíndricos NBI están disponibles en una amplia variedad de diseños estandarizados. Las variantes de diseño más importantes se muestran en la figura 1.

El aro exterior de los rodamientos con diseño NU tiene dos pestañas integrales, mientras que el aro interior no lleva pestañas.

En el diseño N, el aro interior tiene dos pestañas integrales y el aro exterior no lleva pestañas.

En los rodamientos cilíndricos de los tipos NU y N, el rodamiento permite la compensación de la variación de longitud del eje por efecto de la temperatura. Esto los hace idóneos para su uso como rodamientos libres. Por tanto, estos rodamientos no pueden admitir cargas axiales.

Los rodamientos de rodillos cilíndricos del tipo NJ tienen dos pestañas integrales en el aro exterior y una en el aro interior. Los de tipo NF tienen una pestaña integral en el aro exterior y dos en el interior. Esto les permite aceptar cargas axiales en un sentido, lo que les convierte en rodamientos de apoyo.

These bearing design types allow the rollers to run directly onto the contacting surface of either the shaft or in the housing.

However, in such bearing arrangements the contacting surface parts must be hardened and ground as for regular bearing raceways.

### Standard design variants

NBI single row cylindrical roller bearings are available in several basic designs as standard.

The most important design variants are shown below (see Fig. 1).

NU - type bearings feature an outer ring with two fixed lips (flanges) whilst the inner ring is plain.

N - design bearings have two fixed lips on the inner ring and a plain outer ring.

NU and N design cylindrical roller bearings allow for a compensation of length changes of the shaft due to thermal expansion within the bearing. This makes them perfect floating (non - locating) bearings. These bearing designs, therefore, are not suitable to accommodate any thrust force.

NJ - type cylindrical roller bearings feature two fixed lips on their outer ring and one lip on the inner ring. Bearings of NF design have one fixed lip on their outer ring and two lips on the inner ring. This allow for accepting single direction acting thrust forces what make them semi - locating bearing types.

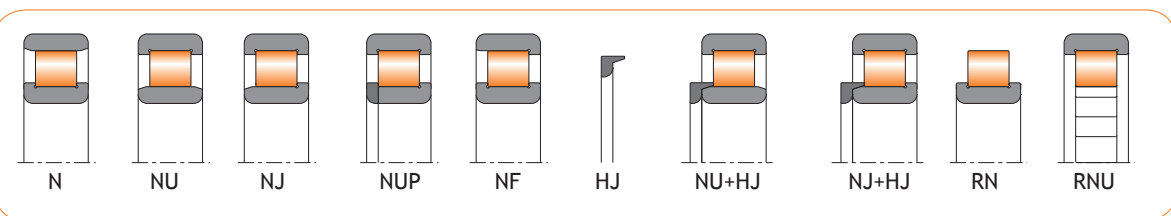

Fig. 1



## 2.1 Rodamientos de una hilera de rodillos cilíndricos con jaula *Single row cylindrical roller bearings with cage*

Los rodamientos de rodillos cilíndricos del tipo NUP son rodamientos fijos. Su diseño presenta dos pestañas integrales en el aro exterior, una pestaña integral en el aro interior y una arandela suelta. Estos rodamientos puede admitir cargas axiales en ambos sentidos. Actúan como rodamientos fijos.

Los aros angulares HJ se utilizan en conjunto con los rodamientos de rodillos cilíndricos para el guiado de ejes.

Los rodamientos de rodillos cilíndricos del tipo NJ, cuando se usan conjuntamente con los aros angulares HJ, pueden usarse como rodamientos fijos, y por tanto, proporcionar un guiado axial del eje en uno o ambos sentidos.

Cuando se utilizan los aros angulares HJ junto con los rodamientos de rodillos cilíndricos del tipo NU, debe prestarse atención para evitar la obstrucción de los rodillos. Los rodamientos del tipo NU con aros HJ pueden admitir cargas axiales en un solo sentido. Dado que estos rodamientos son de uso poco frecuente no se han incluido en las tablas de datos de este capítulo; contacte con el departamento comercial de NBI para solicitar información acerca de los rodamientos de esta serie.

### **Diseño interno reforzado, sufijo E**

Los rodamientos NBI de una hilera de rodillos cilíndricos, hasta un cierto tamaño se fabrican de forma estándar en tipo E.

El tipo E incorpora un diseño interno optimizado que incrementa la capacidad de carga y por tanto, un rendimiento óptimo.

En el caso de los rodamientos de rodillos cilíndricos de gran tamaño y en el caso de las series 10 y 4, el tipo NO-E permanece cómo estándar.

Para operaciones de mantenimiento, se puede solicitar el diseño NO-E. Por tanto, bajo petición, se puede fabricar cualquier tipo en diseño NO-E.

NUP type cylindrical roller bearings are locating bearings. This design variant features two fixed lips on their outer ring, one integral lip on the inner ring and a loose rib. NUP - type bearings can accommodate limited thrust forces in either direction. They act as locating bearings.

HJ type thrust collars are being used in conjunction with cylindrical roller bearings for guiding shafts.

When used with HJ type thrust collars, semi locating NJ - type cylindrical roller bearings can be turned into locating bearings, hence providing a guidance in both directions.

NU type cylindrical roller bearings should not be used with HJ thrust collars for preventing an erroneously clamping of the rollers. NU type cylindrical roller bearings with a HJ thrust collar are able to take up thrust forces acting in one direction only. Since these bearings are seldom used they have not been included in the data tables; please, contact NBI sales department to request further information about these series.

### **Reinforced internal design, suffix E**

NBI single row cylindrical roller bearings are produced with the E design as standard up to a certain size.

The E design incorporates an optimized internal design including more and larger rollers gaining increased load ratings and thus optimum performance.

However, for larger cylindrical roller bearings and bearing types of the series 10 and 4, the NON-E design remains the standard.

In same applications, including repair and overhaul, the traditional NON-E-design remains. Therefore, the traditional NON-E-design can be produced by NBI to customers order for all sizes.



## Rodamientos con agujero cónico

Los rodamientos de una hilera de rodillos cilíndricos NBI también se pueden suministrar bajo pedido con agujero cónico en conicidad 1:12. Los rodamientos con un agujero cónico tienen un juego radial interno mayor que los rodamientos correspondientes con un agujero cilíndrico (ver tabla 2 en pág. 13) y se identifican por el sufijo K en su designación.

## Desalineación

Los rodamientos operando en condiciones de desalineación están sometidos a fuerzas adicionales que reducen su vida útil y que pueden generar un elevado ruido de funcionamiento, vibraciones y temperaturas excesivas.

Los rodamientos de rodillos cilíndricos NBI presentan una geometría de los elementos en contacto modificada para minimizar el efecto negativo de las tensiones en los extremos entre los rodillos y las pistas de rodadura.

Esta geometría modificada incluye elementos rodantes con un perfil exterior modificado y una geometría de la pista de rodadura optimizada, denominada, coronada.

En condiciones normales de funcionamiento el desalineación no debe exceder de 2 minutos angulares. En el caso en que se requiera soportar desalineaciones mayores, NBI también suministra rodamientos de rodillos cilíndricos con un perfil especial en la pista de rodadura del aro interior (sufijo -PE).

## Tolerancias

Los rodamientos de rodillos cilíndricos NBI se fabrican, como estándar, con una tolerancia Normal (PN).

Se pueden suministrar bajo pedido rodamientos fabricados con tolerancias geométricas y dimensionales más ajustadas.

## Bearings with tapered bore

NBI single row cylindrical roller bearings can also be supplied, under request, with a tapered bore 1:12. Bearings with a tapered bore have a larger radial internal clearance than corresponding bearings with a cylindrical bore (see table 2 in page 13) and are identified by the designation suffix K.

## Misalignment

Bearings running misaligned are subjected to additional forces resulting in reduced bearing life and also may generate high running noise, vibrations and excessive operating temperatures.

NBI single row cylindrical roller bearings feature optimized internal contact geometry to minimize the negative effect of edge loading stresses between the rollers and the contacting races.

This optimized internal contact geometry includes rollers having a modified outer profile including an optimized i.e. so crowned raceway geometry.

For normal operating conditions, the maximum misalignment between inner and outer ring must not exceed 2 angular minutes.

In cases where higher misalignments may occur, NBI also supplies cylindrical roller bearings with special profile on the inner ring raceway to customer orders (suffix -PE).

## Tolerances

NBI single row cylindrical roller bearings are produced to tolerance class PN as standard.

NBI bearings can be produced with closer tolerances according to customers requirements.

For obtaining detailed values on tolerances refer to the chapter *Bearing data and Tolerances*.



En el capítulo *Datos de los rodamientos/Tolerancias* se ofrece una información más detallada acerca de las clases de tolerancia.

### Jaulas

Los rodamientos de rodillos cilíndricos NBI de tipo E, están provistos de jaulas de poliamida reforzada con fibra de vidrio de forma estándar (sufijo -TVP2). Los tamaños más grandes utilizan principalmente jaula mecanizada de latón de dos piezas con remaches integrales (sufijo -M1, como estándar o -M2, como opción).

Los rodamientos de una hilera de rodillos cilíndricos NBI de diseño NO-E, están provistos habitualmente de jaula de acero estampado como estándar (sufijo -J).

Las excepciones son los rodamientos de mayor tamaño de las series 10 y 4, los cuales se fabrican con jaulas mecanizadas de latón con remaches de acero (sufijo -M) de formar estándar.

Los rodamientos de rodillos cilíndricos NBI también están disponibles, bajo petición del cliente, con otros tipos de jaulas.

### Juego radial interno

Los rodamientos de rodillos cilíndricos de una hilera NBI se fabrican, de forma estándar, con juego interno normal (grupo CN).

Los rodamientos de una hilera de rodillos cilíndricos NBI también se pueden fabricar en otros grupos de tolerancia bajo pedido.

Estos valores están estandarizados y son conformes a los estándares internacionales en vigor, DIN 620 parte 4 e ISO 5753-1991.

Los valores de los diferentes grupos de juego interno de los rodamientos de una y dos hileras de rodillos cilíndricos NBI se listan en las tablas 1 y 2 (págs. 12 y 13).

### Cages

NBI E Type cylindrical roller bearings are normally fitted with glass fiber reinforced polyamide cages (suffix -TVP2) as standard. Bigger sizes are mainly fitted with a two-piece machine brass cage with integral rivets (suffixes -M1 as standard or -M2 as optional).

Non-E design NBI single row cylindrical roller bearings are normally fitted with pressed steel cages as standard (suffix -J).

Exceptions are larger cylindrical roller bearings and bearings of the series 10 and 4 which are produced with machined solid brass cages with steel rivets (suffix -M) as standard.

NBI cylindrical roller bearings are also available with other cage designs and cage materials on order request.

### Internal radial clearance

NBI single row cylindrical roller bearings are standard produced with normal internal clearance (group CN).

NBI cylindrical roller bearings can also produce to other internal clearance groups to order.

The clearance values correspond, as far as they are standardized, to the relevant international standards DIN 620 part 4 and ISO 5753 - 1991.

Values of the different internal clearance groups of single row NBI cylindrical roller bearings are listed in tables 1 and 2 (pages 12 and 13).

### Juego radial interno no estándar

Los rodamientos de una hilera de rodillos cilíndricos NBI también pueden fabricarse con juegos internos especificados individualmente bajo pedido.

Esto incluye la posibilidad de suministrar rodamientos con un juego restringido a una parte de la banda de tolerancia, por ej. C2L, C3M, etc.

En el caso de que el juego interno pertenezca al grupo C1, los componentes desarmables no son intercambiables y no deben mezclarse para mantener el juego interno correcto.

### Temperatura de funcionamiento

Los rodamientos de rodillos cilíndricos con jaula, se pueden utilizar para temperaturas de funcionamiento desde -30°C hasta +150°C. En caso de que la temperatura en servicio supere los 120°C de forma continua, rogamos consulten con el departamento de ingeniería de aplicaciones de NBI.

Los rodamientos provistos de jaula de poliamida reforzada con fibra de vidrio (sufijo -TVP2) son apropiados hasta +120°C.

### Carga mínima

Los rodamientos en general requieren una carga mínima radial para evitar la fricción por deslizamiento. En el caso de los rodamientos de rodillos cilíndricos, se requiere una carga radial mínima del 4% de la capacidad de carga dinámica Cr.

### Capacidad de carga axial dinámica

Los rodamientos de rodillos cilíndricos están diseñados para acomodar cargas radiales principalmente. Algunos diseños también son apropiados para acomodar cargas axiales de cierta magnitud que actúen en uno o ambos sentidos.

*Continúa en pág. 14*

### Non-standardized clearances

NBI cylindrical roller bearings can also produce with individually defined special internal clearances to order.

This includes the possibility of producing bearings with a clearance restricted to a part of the full clearance range only, i.e. C2L, C3M, etc.

In case of internal clearance group C1, individual components are not interchangeable and must not be mixed to maintain the correct operating clearance.

### Operating temperature

Single row cylindrical roller bearings with cage can be used at operating temperatures from -30°C to +150°C. In case of continuous operating temperatures above 120°C, please contact NBI application engineering department.

Bearings with a plastic cage (suffix -TVP2) are suitable up to +120°C.

### Minimum load

Rolling bearings require a sufficient minimum radial load to prevent excessive sliding friction. Particularly cylindrical roller bearings require a minimum radial load of more than 4% of the dynamic load rating Cr.

### Dynamic axial load carrying capacity

Cylindrical roller bearings are primarily designed to accommodate radial loads. Several designs are also suitable to accept thrust forces acting in one or both directions to a limited extend.

*Continues on page 14*



## 2.1 Rodamientos de una hilera de rodillos cilíndricos con jaula Single row cylindrical roller bearings with cage

Juego radial interno en  $\mu\text{m}$  de los rodamientos de una hilera de rodillos cilíndricos **NBI**  
con eje cilíndrico  
*Internal clearance in  $\mu\text{m}$  of NBI single row cylindrical roller bearings  
with cylindrical bore*

Juego radial Clearance group	Diámetro de eje / Bore diameter (mm)														
	>	-	24	30	40	50	65	80	100	120	140	160	180	200	225
	≤	24	30	40	50	65	80	100	120	140	160	180	200	225	250
C1	min	5	5	5	5	5	10	10	10	10	10	10	15	15	15
	max	15	15	15	18	20	25	30	30	35	35	40	45	50	50
C2	min	0	0	5	5	10	10	15	15	15	20	25	35	45	45
	max	25	25	30	35	40	45	50	55	60	70	75	90	105	110
CN	min	20	20	25	30	40	40	50	50	60	70	75	90	105	110
	max	45	45	50	60	70	75	85	90	105	120	125	145	165	175
C3	min	35	35	45	50	60	65	75	85	100	115	120	140	160	170
	max	60	60	70	80	90	100	110	125	145	165	170	195	220	235
C4	min	50	50	60	70	80	90	105	125	145	165	170	195	220	235
	max	75	75	85	100	110	125	140	165	190	215	220	250	280	300
C5	min	75	75	85	100	110	125	140	180	190	215	220	250	280	300
	max	100	100	110	130	140	160	175	220	235	265	270	305	340	365

Juego radial Clearance group	Diámetro de eje / Bore diameter (mm)														
	>	250	280	315	355	400	450	500	560	630	710	800	900	1.000	1.120
	≤	280	315	355	400	450	500	560	630	710	800	900	1.000	1.120	1.250
C1	min	20	20	20	25	25	25	25	30	30	35	35	35	50	230
	max	55	60	65	75	85	95	100	110	130	140	160	180	200	470
C2	min	55	55	65	100	110	110	120	140	145	150	180	200	220	230
	max	125	130	145	190	210	220	240	260	285	310	350	390	430	470
CN	min	125	130	145	190	210	220	240	260	285	310	350	390	430	470
	max	195	205	225	280	310	330	360	380	425	470	520	580	640	710
C3	min	190	200	225	280	310	330	360	380	425	470	520	580	640	710
	max	260	275	305	370	410	440	480	500	565	630	690	770	850	950
C4	min	260	275	305	370	410	440	480	500	565	630	690	770	850	950
	max	330	350	385	460	510	550	600	620	705	790	860	960	1.060	1.190
C5	min	330	350	385	460	510	550	600	620	705	790	860	960	1.060	1.510
	max	400	425	465	550	610	660	720	740	845	950	1.030	1.150	1.270	1.750

Tabla 1. Table 1

Juego radial interno en  $\mu\text{m}$  de los rodamientos de una hilera de rodillos cilíndricos NBI  
con eje cónico

*Internal clearance in  $\mu\text{m}$  of NBI single row cylindrical roller bearings  
with tapered bore*

Juego radial Clearance group	Diámetro de eje / Bore diameter (mm)														
	>	-	24	30	40	50	65	80	100	120	140	160	180	200	225
	≤	24	30	40	50	65	80	100	120	140	160	180	200	225	250
C1	min	10	15	15	17	20	25	35	40	45	50	55	60	60	65
	max	20	25	25	30	35	40	55	60	70	75	85	90	95	100
C2	min	15	20	20	25	30	35	40	50	55	60	75	85	95	105
	max	40	45	45	55	60	70	75	90	100	110	125	140	155	170
CN	min	30	35	40	45	50	60	70	90	100	110	125	140	155	170
	max	55	60	65	75	80	95	105	130	145	160	175	195	215	235
C3	min	40	45	55	60	70	85	95	115	130	145	160	180	200	220
	max	65	70	80	90	100	120	130	155	175	195	210	235	260	285
C4	min	50	55	70	75	90	110	120	140	160	180	195	220	245	270
	max	75	80	95	105	120	145	155	180	205	230	245	275	305	335
C5	min	75	80	95	105	120	145	155	180	205	230	245	275	305	335
	max	100	105	120	135	150	180	190	220	250	280	295	330	365	400

Juego radial Clearance group	Diámetro de eje / Bore diameter (mm)														
	>	250	280	315	355	400	450	500	560	630	710	800	900	1.000	1.120
	≤	280	315	355	400	450	500	560	630	710	800	900	1.000	1.120	1.250
C1	min	75	80	90	100	110	120	130	140	160	170	190	210	230	-
	max	110	120	135	150	170	190	210	230	260	290	330	360	400	-
C2	min	115	130	145	165	185	205	230	260	295	325	370	410	455	490
	max	185	205	225	255	285	315	350	380	435	485	540	600	665	730
CN	min	185	205	225	255	285	315	350	380	435	485	540	600	665	730
	max	255	280	305	345	385	425	470	500	575	645	710	790	875	970
C3	min	240	265	290	330	370	410	455	500	565	630	700	780	865	960
	max	310	340	370	420	470	520	575	620	705	790	870	970	1075	1.200
C4	min	295	325	355	405	455	505	560	620	695	775	860	960	1065	1.200
	max	365	400	435	495	555	615	680	740	835	935	1.030	1.150	1.275	1.440
C5	min	365	400	435	495	555	615	680	740	835	935	1.030	1.150	1.275	-
	max	435	475	515	585	655	725	800	860	975	1.095	1.200	1.340	1.485	-

Tabla 2. Table 2



## 2.1 Rodamientos de una hilera de rodillos cilíndricos con jaula *Single row cylindrical roller bearings with cage*

Las cargas axiales aplicadas a los rodamientos de rodillos cilíndricos generan una fricción por deslizamiento entre las caras laterales de los rodillos y los flancos de guiado de las pestañas integrales.

Por tanto, es esencial una lubricación óptima. Una fuerza axial provoca un momento de fuerza en los rodillos.

Esto requiere una carga radial adicional para asegurar un funcionamiento eficaz del rodamiento.

Las cargas axiales aplicadas al rodamiento no deben exceder los siguientes límites:

$$F_a \leq 0,4 \cdot F_r$$

y

$$F_a \leq 0,1 \cdot C_r$$

En cualquier caso, los rodamientos de rodillos cilíndricos cargados axialmente requieren adicionalmente:

- lubricación adecuada
- inexistencia de cargas de choque
- suficiente disipación del calor
- soporte adecuado de las flancos del rodamiento por los componentes adyacentes

### Carga dinámica equivalente

Los rodamientos de rodillos cilíndricos de los tipos NU, N son rodamientos libres ya que no pueden aceptar cargas axiales.

En estos rodamientos se cumple:

$$P = F_r$$

En el caso de rodamientos de una hilera de rodillos cilíndricos con pestañas integrales en los aros interior y exterior se cumple:

Si  $\frac{F_a}{F_r} \leq e$ , entonces:  $P = F_r$

Thrust forces applied to cylindrical roller bearings generate sliding friction between the roller end faces and the guiding flanges.

Hence, an optimum lubrication is crucial. Furthermore, every thrust load creates a tilting moment on the rollers.

This requires an additional radial loading to ensure an effective function of the bearing.

The thrust forces applied to the bearing must not exceed the following limits:

$$F_a \leq 0,4 \cdot F_r$$

and

$$F_a \leq 0,1 \cdot C_r$$

However, axially loaded cylindrical roller bearings also require:

- adequate lubrication
- no shock loads
- sufficient heat dissipation
- an adequate support of the bearing flanges by the adjacent parts

### Equivalent dynamic bearing load

N and NU type cylindrical roller bearings are non-locating bearings as they are unable to accept any thrust loads.

For these bearing types and all other only radially loaded cylindrical roller bearings apply:

$$P = F_r$$

In the case of single row cylindrical roller bearings having lips on inner or outer rings, the following formula applies:

If  $\frac{F_a}{F_r} \leq e$ , then:  $P = F_r$

O si  $\frac{F_a}{F_r} > e$ , entonces:  $P = X \cdot F_r + Y \cdot F_a$

Or if  $\frac{F_a}{F_r} > e$ , then:  $P = X \cdot F_r + Y \cdot F_a$

Series de rodamientos <i>Bearing series</i>	Factores de cálculo / <i>Calculation factors</i>		
	e	X	Y
10, 18, 19, 2, 3, 4	0,2	0,92	0,6
22, 23	0,3	0,92	0,4

Tabla 3. Table 3

### Carga estática equivalente

En los rodamientos de rodillos cilíndricos de una hilera se cumple:

$$P_0 = F_r$$

### Dimensiones de los chaflanes

Los resaltes de las piezas de maquinaria adyacentes se deben diseñar de forma que garanticen el soporte axial requerido por los aros de los rodamientos.

Los aros de los rodamientos deben contactar con las piezas adyacentes solo a través de sus caras laterales.

Los chaflanes de los rodamientos no deben contactar con los redondeos del eje ni del alojamiento.

Por tanto, el radio máximo del chaflán ( $r_g$ ) debe ser menor que el chaflán mínimo de los aros del rodamiento ( $r_s$ ), tal y como se expone en las tablas de rodamientos (ver fig.2, pág. 16).

En la norma DIN 5418 se proporcionan directrices para dimensionar las partes adyacentes.

Los rodamientos de rodillos cilíndricos sometidos a elevadas cargas axiales requieren una fijación de sus flancos de al menos el 50% de su sección radial.

### Equivalent static bearing load

For single row cylindrical roller bearings applies:

$$P_0 = F_r$$

### Abutment and fillet dimensions

The shoulders on adjacent machine parts must be designed in such a way that the required axial support of the bearing rings is guaranteed.

The bearing rings must contact adjacent parts with their side faces only.

The bearing chamfers must not contact the shoulder fillet radii of shaft or housing shoulders.

Therefore, the largest fillet radius ( $r_g$ ) must be kept smaller than the minimum fillet dimension of the bearing rings ( $r_s$ ) as listed in the product tables (see fig. 2, page 16).

Recommendations for the dimensions of adjacent parts are given in DIN 5418.

Cylindrical roller bearings subjected to high thrust loads require a support of the bearing flanges over 50% of their radial section or greater.



## 2.1 Rodamientos de una hilera de rodillos cilíndricos con jaula Single row cylindrical roller bearings with cage

Las dimensiones adyacentes pueden calcularse como sigue:

- Para resaltes de eje:

$$dw_{\min} = \frac{F + d_1}{2}$$

- Para resaltes de alojamiento:

$$Dw_{\min} = \frac{E + D_1}{2}$$

Dónde:

$dw_{\min}$  = diámetro mínimo del resalte de eje

F = diámetro de la pista de rodadura del aro interior, ver tablas de producto

$d_1$  = diámetro exterior de la pestaña del aro interior, ver tablas de producto

$Dw_{\min}$  = diámetro mínimo del resalte del alojamiento

E = diámetro de la pista de rodadura del aro exterior, ver tablas de producto

$D_1$  = diámetro interior de la pestaña del aro exterior, ver tablas de producto

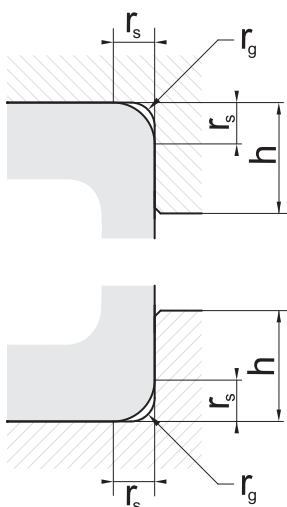

Fig. 2

The adjacent dimensions can be calculated as follows:

- For shaft shoulders:

$$dw_{\min} = \frac{F + d_1}{2}$$

- For housing shoulders:

$$Dw_{\min} = \frac{E + D_1}{2}$$

Where:

$dw_{\min}$  = minimum shaft shoulder diameter

F = inner ring raceway diameter, see product tables

$d_1$  = outer diameter of inner ring shoulder, see product tables

$Dw_{\min}$  = minimum housing shoulder diameter

E = outer ring raceway diameter, see product tables

$D_1$  = inner diameter of outer ring shoulder, see product tables

rs min	rg max	$h_{\min}$		
		Series de rodamientos Bearing Series		
		18, 19, 20	2, 2E 22, 22E 3, 3E 23, 23E	4
0,3	0,3	1	1,2	-
0,6	0,6	1,6	2,1	-
1	1	2,3	2,8	-
1,1	1	3	3,5	4,5
1,5	1	3,5	4,5	5,5
1,5	3,5	4,4	5,5	6,5
2	2	5,1	6	7
2,1	2,1	6,2	7	8
3	2,5	7,3	8,5	10
4	3	9	10	12
5	4	11,5	13	15

Tabla 4. Table 4



## Diseño de los asientos de los rodamientos como pistas de rodadura

En aplicaciones donde el espacio está limitado, puede ser ventajoso utilizar un conjunto de jaula y rodillos con uno aro, el interior o el exterior, para reducir el tamaño de la disposición de rodamientos.

En estos casos los rodillos circulan directamente sobre la superficie del eje o alojamiento. Estas superficies de contacto deben estar templadas y rectificadas, al igual que las pistas de rodadura de los rodamientos.

Los diseños habituales para estas aplicaciones son los de las series RNU y RN.

La superficie de contacto en el eje o alojamiento se debe fabricar con una tolerancia g6 o k6, respectivamente, de acuerdo a los campos de tolerancias ISO.

Los diámetros de los resaltes de guiado en los ejes o alojamientos deben concordar con los respectivos diámetros de las pestañas de los rodamientos ( $d_1$  o  $D_1$ ), dadas en las tablas de producto. (NOTA: referirse a los datos de los rodamientos completos dado que los tipos RN y RNU no se detallan en las tablas. Y en caso de requerir información adicional consulten con nuestro departamento comercial).

Para más información acerca del diseño de las pistas de rodadura léase el capítulo: *Diseño del alojamiento de los rodamientos*.

## Designaciones complementarias

Las tablas de producto recogen las configuraciones de rodamiento estandarizadas en la fecha de edición de este catálogo. Dichas configuraciones estandarizadas se reflejan en el correspondiente sufijo o sufijos de cada rodamiento.

En cualquier caso NBI puede ofrecer, bajo pedido, diseños alternativos, tanto los recogidos en la tabla siguiente como otros muchos cuya relación excede el propósito del presente catálogo y que

## Design of bearing seats as raceways

In applications with limited space it may be advantageous using a cage and roller assembly with an outer or inner ring only in order to save on sectional height.

In these cases, the rollers run directly on the surfaces of shaft or housing. These contacting surfaces must be hardened and ground as for bearing raceways.

Typical types for these applications are RNU Series or RN series.

The contacting surface on shaft or housing acting as raceway must be produced to ISO tolerance field g6 and K6 respectively.

The diameters of the guiding flanges on shaft or housing must be in accordance with the respective shoulder diameters ( $d_1$  or  $D_1$ ), as given by the product tables. (NOTE: refer to the data of complete bearings due to these types, RN and RNU are not detailed in the data table and if further information is required, consult us).

For detailed information on the design layout of raceways see chapter *Design of bearing location*.

## Supplementary designations

The product tables show the standardized bearing configurations updated on the edition of this catalogue. These standardized configurations correspond to suffix or suffixes of each bearing.

In any case, NBI can offer, under requirement, alternative designs, comprising the ones showed in the following table or many others, whose mention exceeds the purpose of the present catalogue, and can be found in specific technical



## 2.1 Rodamientos de una hilera de rodillos cilíndricos con jaula *Single row cylindrical roller bearings with cage*

podrán encontrarse en las publicaciones técnicas específicas de aplicaciones concretas o de series de rodamientos concretos.

En caso de requerir un diseño especial no recogido en estas páginas, consulten al departamento comercial de **NBI Bearings Europe**.

publications of concrete applications or series of specific bearings.

Should you need a special design not existent in these pages, please contact our Sales Department in **NBI Bearings Europe**.

Sufijo <i>Suffix</i>	Descripción	<i>Description</i>
<b>C2</b>	Juego radial menor que el normal	<i>Radial internal clearance smaller than normal</i>
<b>C1</b>	Juego radial menor que C2	<i>Radial internal clearance smaller than C2</i>
<b>C3</b>	Juego radial mayor que el normal	<i>Radial internal clearance larger than normal</i>
<b>C4</b>	Juego radial mayor que C3	<i>Radial internal clearance larger than C3</i>
<b>E</b>	Diseño interno optimizado para incrementar la capacidad de carga	<i>Modified internal design to increase the load capacity</i>
<b>TVP2</b>	Jaula de poliamida reforzada con fibra de vidrio	<i>Glass fiber reinforced polyamide cage</i>
<b>M</b>	Jaula de latón con remaches de acero guiada por los rodillos	<i>Solid brass cage with steel rivets, roller guided</i>
<b>MA</b>	Jaula de latón con remaches de acero guiada por el aro exterior	<i>Solid brass cage with steel rivets, outer ring guided</i>
<b>MB</b>	Jaula de latón con remaches de acero guiada por el aro interior	<i>Solid brass cage with steel rivets, inner ring guided</i>
<b>M1</b>	Jaula de latón con remaches trapezoidales integrales de latón, remachados en caliente, guiada por los rodillos	<i>Solid brass cage with trapezoid integral brass rivets, hot riveted, roller guided</i>
<b>M1A</b>	Jaula de latón con remaches trapezoidales integrales de latón, remachados en caliente, guiada por el aro exterior	<i>Solid brass cage with trapezoid integral brass rivets, hot riveted, outer ring guided</i>
<b>M1B</b>	Jaula de latón con remaches trapezoidales integrales de latón, remachados en caliente, guiada por el aro interior	<i>Solid brass cage with trapezoid integral brass rivets, hot riveted, inner ring guided</i>
<b>M2</b>	Jaula de latón con remaches cilíndricos integrales de latón, remachados en caliente, guiada por los rodillos	<i>Solid brass cage with cylindrical integral brass rivets, hot riveted, roller guided</i>
<b>M2A</b>	Jaula de latón con remaches cilíndricos integrales de latón, remachados en caliente, guiada por el aro exterior	<i>Solid brass cage with cylindrical integral brass rivets, hot riveted, outer ring guided</i>
<b>M2B</b>	Jaula de latón con remaches cilíndricos integrales de latón, remachados en caliente, guiada por el aro interior	<i>Solid brass cage with cylindrical integral brass rivets, hot riveted, inner ring guided</i>
<b>MPA</b>	Jaula de una pieza de latón, guiada por el aro exterior	<i>Single piece solid brass cage, outer ring guided</i>
<b>MPB</b>	Jaula de una pieza de latón, guiada por el aro interior	<i>Single piece solid brass cage, inner ring guided</i>
<b>J</b>	Jaula de chapa de acero	<i>Pressed steel cage</i>

Sufijo Suffix	Descripción	Description
<b>PE</b>	Diseño interno optimizado para incrementar la capacidad de admitir desalineación	<i>Modified internal design to increase the misalignment capacity</i>
<b>K</b>	Agujero cónico, conicidad 1:12	<i>Tapered bore, taper 1:12</i>
<b>CE01</b>	Rodamientos para motores de tracción de ferrocarriles	<i>Bearings for traction motors of railway vehicles</i>
<b>CE02</b>	Rodamientos para cajas de grasa de ferrocarril	<i>Bearings for railway axle box applications</i>
<b>CE03</b>	Pavonados	<i>Black oxide coated</i>
<b>CE04</b>	Fosfatados	<i>Phosphate coated</i>
<b>CE09</b>	Rodamientos para aplicaciones de aerogeneración	<i>Bearings for wind energy applications</i>
<b>ENH</b>	Rodamiento perteneciente a la línea $\epsilon^*$ Enhanced, cuyas cargas dinámicas corresponden a los valores de $Cr \epsilon^*$ . (Como referencia se muestran también, en las tablas de producto, los valores de $Cr$ calculados según la norma ISO 281)	<i><math>\epsilon^*</math> Enhanced bearing series whose dynamic load rating corresponds to <math>Cr \epsilon^*</math> values. (As reference, <math>Cr</math> values calculated according to ISO 281 are shown in the product tables)</i>

Tabla 5. Table 5

## NOTAS / NOTES

---



---



---



---



---



---



---



---



---



---



---



---



---



---



---



---



---



---



---



---



---



---



---



## 2.1.1 Rodamientos de una hilera de rodillos cilíndricos con jaula Single row cylindrical roller bearings with cage

### RODAMIENTOS LIBRES / NON-LOCATING BEARINGS

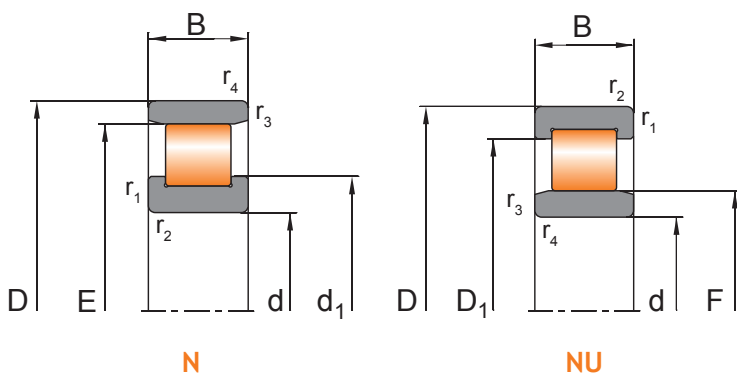

DIMENSIONES* BOUNDARY DIMENSIONS*			DESIGNACION DESIGNATION	$\epsilon^*$	CAPACIDAD DE CARGA (kN) LOAD RATING (kN)			CARGA LIMITE DE FATIGA (kN) FATIGUE LIMIT LOAD (kN)
d	D	B			dyn. Cr	dyn. $\epsilon^*$ Cr $\epsilon^*$	stat. Cor	Cu
15	35	11	N202-E-TVP2	$\epsilon^*$	13,2	14	10,3	1,25
	35	11	NU202-E-TVP2	$\epsilon^*$	13,2	14	10,3	1,25
17	40	12	N203-E-TVP2	$\epsilon^*$	17,1	18,1	14,4	1,8
	40	12	NU203-E-TVP2	$\epsilon^*$	17,1	18,1	14,4	1,8
20	40	16	NU2203-E-TVP2	$\epsilon^*$	25	26,5	21,8	3,4
	47	14	NU303-E-TVP2	$\epsilon^*$	28,6	30	21	2,6
	47	14	N204-E-TVP2	$\epsilon^*$	28,8	30,1	22,6	3
	47	14	NU204-E-TVP2	$\epsilon^*$	28,8	30,1	22,6	3
25	47	18	NU2204-E-TVP2	$\epsilon^*$	36,4	38,1	29,2	4,4
	52	21	NU2304-E-TVP2	$\epsilon^*$	45,7	48	38	5,8
	52	15	NU304-E-TVP2	$\epsilon^*$	34,7	36,3	26	3,3
	47	12	NU1005-M	-	16	-	13	1,5
	52	15	N205-E-TVP2	$\epsilon^*$	31,8	33,3	27,1	3,5
30	52	15	NU205-E-TVP2	$\epsilon^*$	31,8	33,3	27,1	3,5
	52	18	NU2205-E-TVP2	$\epsilon^*$	33,9	35,9	34,2	4,3
	62	17	N305-E-TVP2	$\epsilon^*$	45,1	47,1	36,5	4,6
	62	17	NU305-E-TVP2	$\epsilon^*$	45,1	47,1	36,5	4,6
	62	24	NU2305-E-TVP2	$\epsilon^*$	63,1	65,8	55	9
	62	16	NU1006-M	-	20	-	17,6	2,2
	62	16	N206-E-TVP2	$\epsilon^*$	42,4	44,4	36,1	4,6
	62	16	NU206-E-TVP2	$\epsilon^*$	42,4	44,4	36,1	4,6
35	62	20	NU2206-E-TVP2	$\epsilon^*$	53,3	56,4	49	7,9
	72	19	N306-E-TVP2	$\epsilon^*$	57,9	60,7	48	6,4
	72	19	NU306-E-TVP2	$\epsilon^*$	57,9	60,7	48	6,4
	72	27	NU2306-E-TVP2	$\epsilon^*$	79,5	83,2	75	10
	90	23	NU406-M	-	75	-	60	10
	72	17	NU1007-M	-	29	-	26,8	3,5
	72	17	N207-E-TVP2	$\epsilon^*$	54,5	57,4	48,2	6,2
80	72	17	NU207-E-TVP2	$\epsilon^*$	54,5	57,4	48,2	6,2
	72	23	NU2207-E-TVP2	$\epsilon^*$	67,7	70,6	63,4	9,5
	80	21	N307-E-TVP2	$\epsilon^*$	72,1	75,8	63	8,5
	80	21	NU307-E-TVP2	$\epsilon^*$	72,1	75,8	63	8,5

\*Dimensiones en mm. / \* Dimensions in mm.

\*\*Masa en kg. / \*\* Mass in kg.

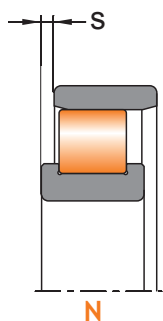

**Axial Displacement (s)**

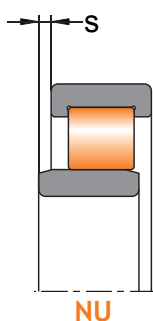

**Axial Displacement (s)**

DESIGNACIÓN DESIGNATION	VELOCIDADES LIMITE SPEED RATINGS (rpm)		$r_1, r_2$ (min)	$r_3, r_4$ (min)	DIMENSIONES SECUNDARIAS SECONDARY DIMENSIONS					MASA** MASS**
	ng aceite ng oil	ng grasa ng grease			E	F	$D_i$	$d_i$	s	
N202-E-TVP2	22.000	17.700	0,6	0,3	30,3	-	-	21,7	0,5	0,047
NU202-E-TVP2	22.000	17.700	0,6	0,3	-	19,3	28,1	-	1,6	0,048
N203-E-TVP2	19.000	15.500	0,6	0,3	35,1	-	-	24,8	1,2	0,067
NU203-E-TVP2	19.000	15.500	0,6	0,3	-	22,1	32,4	-	1,2	0,069
NU2203-E-TVP2	19.000	15.500	0,6	0,3	-	22,1	32,5	-	1,7	0,055
NU303-E-TVP2	17.000	13.900	1	0,6	-	24,2	37,1	-	1,2	0,12
N204-E-TVP2	17.000	13.600	1	0,6	41,5	-	-	29,9	0,8	0,11
NU204-E-TVP2	17.000	13.600	1	0,6	-	26,5	38,7	-	0,8	0,11
NU2204-E-TVP2	17.000	13.600	1	0,6	-	26,5	38,7	-	1,8	0,14
NU2304-E-TVP2	15.000	12.200	1,1	0,6	-	27,5	42,4	-	1,9	0,22
NU304-E-TVP2	15.000	12.200	1,1	0,6	-	27,5	42,4	-	1	0,15
NU1005-M	26.800	21.300	0,6	0,3	-	30,5	39,3	-	2,4	0,09
N205-E-TVP2	16.000	13.000	1	0,6	46,5	-	-	34,7	1,3	0,13
NU205-E-TVP2	16.000	13.000	1	0,6	-	31,5	43,8	-	1,2	0,13
NU2205-E-TVP2	16.000	13.000	1	0,6	-	31,5	43,8	-	1,7	0,17
N305-E-TVP2	13.000	10.300	1,1	1,1	54	-	-	38,1	1,4	0,24
NU305-E-TVP2	13.000	10.300	1,1	1,1	-	34	50,6	-	1,5	0,24
NU2305-E-TVP2	13.000	10.300	1,1	1,1	-	34	50,2	-	1,9	0,34
NU1006-M	23.100	19.000	1	0,6	-	36,5	46,1	-	2,4	0,13
N206-E-TVP2	12.900	10.400	1	0,6	55,5	-	-	41,4	1,4	0,2
NU206-E-TVP2	12.900	10.400	1	0,6	-	37,5	52,3	-	1,5	0,2
NU2206-E-TVP2	12.900	10.400	1	0,6	-	37,5	52,3	-	1,6	0,26
N306-E-TVP2	11.000	8.800	1,1	1,1	62,5	-	-	45,1	0,6	0,36
NU306-E-TVP2	11.000	8.800	1,1	1,1	-	40,5	58,7	-	1,2	0,36
NU2306-E-TVP2	11.000	8.800	1,1	1,1	-	40,5	58,7	-	2,2	0,53
NU406-M	13.500	10.900	1,5	1,5	-	45	66,6	-	2,3	0,85
NU1007-M	19.400	15.700	1	0,6	-	42	52,4	-	2,6	0,17
N207-E-TVP2	10.500	8.600	1,1	0,6	64	-	-	48	0,7	0,3
NU207-E-TVP2	10.500	8.600	1,1	0,6	-	44	60,9	-	0,7	0,3
NU2207-E-TVP2	10.500	8.600	1,1	0,6	-	44	60,9	-	2,2	0,4
N307-E-TVP2	9.800	7.800	1,5	1,1	70,2	-	-	51	0,6	0,48
NU307-E-TVP2	9.800	7.800	1,5	1,1	-	46,2	66,7	-	0,6	0,48

\*Dimensiones en mm. / \* Dimensions in mm.

\*\*Masa en kg. / \*\* Mass in kg.



## 2.1.1 Rodamientos de una hilera de rodillos cilíndricos con jaula Single row cylindrical roller bearings with cage

### RODAMIENTOS LIBRES / NON-LOCATING BEARINGS

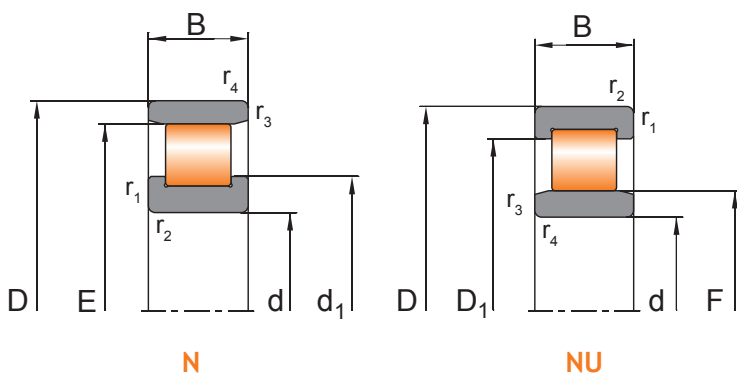

DIMENSIONES* BOUNDARY DIMENSIONS*			DESIGNACION DESIGNATION	$\epsilon^*$	CAPACIDAD DE CARGA (kN) LOAD RATING (kN)			CARGA LIMITE DE FATIGA (kN) FATIGUE LIMIT LOAD (kN)	
d	D	B			dyn. Cr	dyn. $\epsilon^*$ Cr $\epsilon^*$	stat. Cor	Cu	
35	80	31	NU2307-E-TVP2	$\epsilon^*$	101	107	98	13,3	
	100	25	NU407-M	-	86	-	80	10,8	
40	68	15	NU1008-M	-	31,9	-	30	3,3	
	80	18	N208-E-TVP2	$\epsilon^*$	59,3	62,5	53	6,8	
	80	18	NU208-E-TVP2	$\epsilon^*$	59,3	62,5	53	6,8	
	80	23	NU2208-E-TVP2	$\epsilon^*$	78,6	82	75	11	
	90	23	N308-E-TVP2	$\epsilon^*$	88,5	93,7	78	10,3	
	90	23	NU308-E-TVP2	$\epsilon^*$	88,5	93,7	78	10,3	
	90	33	NU2308-E-TVP2	$\epsilon^*$	122	129	119	18,3	
	110	27	NU408-M	-	114	-	93,1	12,3	
	45	75	16	NU1009-M	-	41	-	36,5	5,1
85		19	N209-E-TVP2	$\epsilon^*$	66,9	70,9	63,1	8	
85		19	NU209-E-TVP2	$\epsilon^*$	66,9	70,9	63,1	8	
85		23	NU2209-E-TVP2	$\epsilon^*$	80,8	85,6	81,9	13,4	
100		25	N309-E-TVP2	$\epsilon^*$	110	115	98,2	13	
100		25	NU309-E-TVP2	$\epsilon^*$	110	115	98,2	13	
100		36	NU2309-E-TVP2	$\epsilon^*$	153	161	153	25	
120		29	NU409-M	-	136	-	115	15,5	
50	80	16	NU1010-M	-	43	-	43	5,5	
	90	20	N210-E-TVP2	$\epsilon^*$	70,7	74,7	69,4	9	
	90	20	NU210-E-TVP2	$\epsilon^*$	70,7	74,7	69,4	9	
	90	23	NU2210-E-TVP2	$\epsilon^*$	86,1	90	88	12,4	
	110	27	N310-E-TVP2	$\epsilon^*$	123	130	112	15,5	
	110	27	NU310-E-TVP2	$\epsilon^*$	123	130	112	15,5	
	110	40	NU2310-E-TVP2	$\epsilon^*$	180	190	186	30	
55	130	31	NU410-M	-	170	-	145	23	
	90	18	NU1011-M	-	60	-	60	7,5	
	100	21	N211-E-TVP2	$\epsilon^*$	93,2	98	95	13	
	100	21	NU211-E-TVP2	$\epsilon^*$	93,2	98	95	13	
	100	25	NU2211-E-TVP2	$\epsilon^*$	110	115	118	17	
	120	29	N311-E-TVP2	$\epsilon^*$	151	158	140	19,1	
120	29	NU311-E-TVP2	$\epsilon^*$	151	158	140	19,1		

\*Dimensiones en mm. / \* Dimensions in mm.

\*\*Masa en kg. / \*\* Mass in kg.

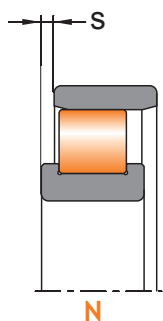

**NU**  
Axial Displacement (s)

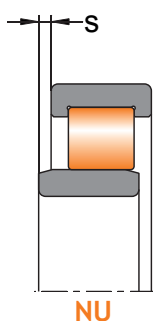

**N**  
Axial Displacement (s)

DESIGNACIÓN DESIGNATION	VELOCIDADES LIMITE SPEED RATINGS (rpm)		$r_1, r_2$ (min)	$r_3, r_4$ (min)	DIMENSIONES SECUNDARIAS SECONDARY DIMENSIONS					MASA** MASS**
	ng aceite ng oil	ng grasa ng grease			E	F	$D_1$	$d_1$	s	
NU2307-E-TVP2	9.800	7.800	1,5	1,1	-	46,2	66,7	-	3	0,72
NU407-M	11.500	9.500	1,5	1,5	-	53	78,2	-	2,6	1,1
NU1008-M	18.500	15.300	1	0,6	-	47	58,2	-	2	0,22
N208-E-TVP2	9.500	7.600	1,1	1,1	71,5	-	-	54	1	0,37
NU208-E-TVP2	9.500	7.600	1,1	1,1	-	49,5	68,3	-	1	0,37
NU2208-E-TVP2	9.500	7.600	1,1	1,1	-	49,5	67,5	-	1,5	0,49
N308-E-TVP2	8.200	6.500	1,5	1,5	80	-	-	57,6	1,2	0,65
NU308-E-TVP2	8.200	6.500	1,5	1,5	-	52	75,5	-	1,3	0,65
NU2308-E-TVP2	8.200	6.500	1,5	1,5	-	52	75,5	-	2,7	0,95
NU408-M	10.000	8.000	2	2	-	58	86,4	-	2,8	1,46
NU1009-M	15.000	12.400	1	0,6	-	52,5	64,5	-	2,5	0,27
N209-E-TVP2	9.000	7.100	1,1	1,1	76,5	-	-	59	1	0,43
NU209-E-TVP2	9.000	7.100	1,1	1,1	-	54,5	73	-	1	0,43
NU2209-E-TVP2	9.000	7.100	1,1	1,1	-	54,5	72,5	-	1,5	0,52
N309-E-TVP2	7.800	6.200	1,5	1,5	88,5	-	-	64,4	1	0,89
NU309-E-TVP2	7.800	6.200	1,5	1,5	-	58,5	83,7	-	1	0,89
NU2309-E-TVP2	7.800	6.200	1,5	1,5	-	58,5	84,1	-	2,5	1,3
NU409-M	9.000	7.400	2	2	-	64,5	93,9	-	2,9	1,85
NU1010-M	14.000	11.500	1	0,6	-	57,5	69,5	-	2,1	0,3
N210-E-TVP2	8.500	6.800	1,1	1,1	81,5	-	-	64	1,3	0,49
NU210-E-TVP2	8.500	6.800	1,1	1,1	-	59,5	78	-	1,3	0,49
NU2210-E-TVP2	8.500	6.800	1,1	1,1	-	59,5	77,7	-	1,3	0,57
N310-E-TVP2	7.000	5.600	2	2	97	-	-	71,3	1,7	1,16
NU310-E-TVP2	7.000	5.600	2	2	-	65	92	-	1,7	1,16
NU2310-E-TVP2	7.000	5.600	2	2	-	65	92	-	3,2	1,73
NU410-M	8.000	6.600	2,1	2,1	-	70,8	103,5	-	3	2,1
NU1011-M	13.000	10.500	1,1	1	-	64	79,2	-	2,1	0,44
N211-E-TVP2	7.500	6.000	1,5	1,1	90	-	-	71	0,8	0,66
NU211-E-TVP2	7.500	6.000	1,5	1,1	-	66	86,2	-	0,8	0,66
NU2211-E-TVP2	7.500	6.000	1,5	1,1	-	66	86,2	-	1,3	0,79
N311-E-TVP2	6.000	4.800	2	2	106,5	-	-	77,7	1,8	1,47
NU311-E-TVP2	6.000	4.800	2	2	-	70,5	101	-	1,8	1,47

\*Dimensiones en mm. / \* Dimensions in mm.

\*\*Masa en kg. / \*\* Mass in kg.



## 2.1.1 Rodamientos de una hilera de rodillos cilíndricos con jaula Single row cylindrical roller bearings with cage

### RODAMIENTOS LIBRES / NON-LOCATING BEARINGS

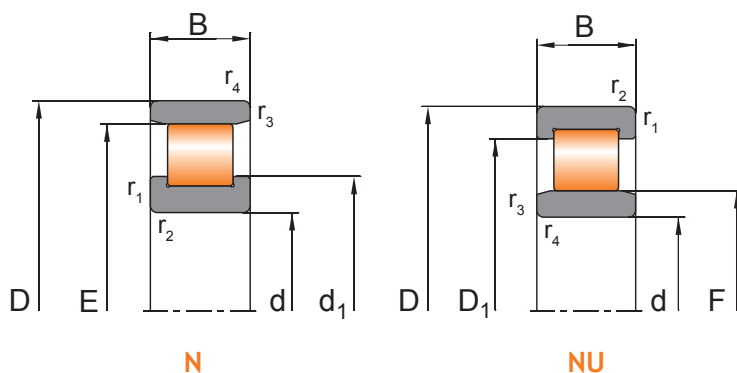

DIMENSIONES* BOUNDARY DIMENSIONS*			DESIGNACION DESIGNATION	$\epsilon^+$	CAPACIDAD DE CARGA (kN) LOAD RATING (kN)			CARGA LIMITE DE FATIGA (kN) FATIGUE LIMIT LOAD (kN)
d	D	B			dyn. Cr	dyn. $\epsilon^+$ Cr $\epsilon^+$	stat. Cor	Cu
55	120	43	NU2311-E-TVP2	$\epsilon^+$	225	234	230	40
	140	33	NU411-M	-	180	-	160	22
60	95	18	NU1012-M	-	50	-	53	7
	110	22	N212-E-TVP2	$\epsilon^+$	105	110	102	13,7
	110	22	NU212-E-TVP2	$\epsilon^+$	105	110	102	13,7
	110	28	NU2212-E-TVP2	$\epsilon^+$	143	150	153	25,4
	130	31	N312-E-TVP2	$\epsilon^+$	168	176	159	21,4
	130	31	NU312-E-TVP2	$\epsilon^+$	168	176	159	21,4
	130	46	NU2312-E-TVP2	$\epsilon^+$	249	263	260	45,5
	150	35	NU412-M	-	200	-	179	24,4
65	100	18	NU1013-M	-	53	-	61	8,1
	120	23	N213-E-TVP2	$\epsilon^+$	118	125	118	16
	120	23	NU213-E-TVP2	$\epsilon^+$	118	125	118	16
	120	31	NU2213-E-TVP2	$\epsilon^+$	163	175	181	28,6
	140	33	N313-E-TVP2	$\epsilon^+$	200	212	195	26
	140	33	NU313-E-TVP2	$\epsilon^+$	200	212	195	26
	140	48	NU2313-E-TVP2	$\epsilon^+$	276	290	285	46
	160	37	NU413-M	-	220	-	200	26
70	110	20	NU1014-M	-	75	-	83	11
	125	24	N214-E-TVP2	$\epsilon^+$	131	138	137	19
	125	24	NU214-E-TVP2	$\epsilon^+$	131	138	137	19
	125	31	NU2214-E-TVP2	$\epsilon^+$	172	182	193	30
	150	35	N314-E-TVP2	$\epsilon^+$	230	240	220	30
	150	35	NU314-E-TVP2	$\epsilon^+$	230	240	220	30
	150	51	NU2314-E-TVP2	$\epsilon^+$	306	320	325	55
	180	42	NU414-M	-	270	-	250	33
75	115	20	NU1015-M	-	76	-	79	11
	130	25	N215-E-TVP2	$\epsilon^+$	145	152	156	21,5
	130	25	NU215-E-TVP2	$\epsilon^+$	145	152	156	21,5
	130	31	NU2215-E-TVP2	$\epsilon^+$	182	191	208	34,3
	160	37	N315-E-TVP2	$\epsilon^+$	268	282	265	34
	160	37	NU315-E-TVP2	$\epsilon^+$	268	282	265	34

\*Dimensiones en mm. / \* Dimensions in mm.

\*\*Masa en kg. / \*\* Mass in kg.



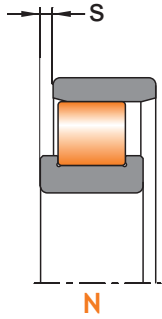

**NU**  
Axial Displacement (s)

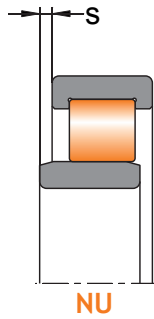

**N**  
Axial Displacement (s)

DESIGNACIÓN DESIGNATION	VELOCIDADES LIMITE SPEED RATINGS (rpm)		$r_1, r_2$ (min)	$r_3, r_4$ (min)	DIMENSIONES SECUNDARIAS SECONDARY DIMENSIONS					MASA** MASS**
	ng aceite ng oil	ng grasa ng grease			E	F	$D_i$	$d_i$	s	
NU2311-E-TVP2	6.000	4.800	2	2	-	70,5	101	-	3,3	2,2
NU411-M	7.400	6.100	2,1	2,1	-	77,2	110	-	3,3	2,5
NU1012-M	12.000	9.800	1,1	1	-	69,5	82,3	-	3,3	0,48
N212-E-TVP2	7.000	5.500	1,5	1,5	100	-	-	77,7	1,6	0,82
NU212-E-TVP2	7.000	5.500	1,5	1,5	-	72	95,7	-	1,6	0,82
NU2212-E-TVP2	7.000	5.500	1,5	1,5	-	72	95,7	-	1,6	1,06
N312-E-TVP2	5.400	4.400	2,1	2,1	115	-	-	84,5	1,9	1,83
NU312-E-TVP2	5.400	4.400	2,1	2,1	-	77	109,5	-	1,8	1,83
NU2312-E-TVP2	5.400	4.400	2,1	2,1	-	77	109,6	-	3,5	2,78
NU412-M	6.900	5.500	2,1	2,1	-	83	117	-	3,4	3
NU1013-M	10.900	8.800	1,1	1	-	74,5	87,3	-	3,3	0,49
N213-E-TVP2	6.200	5.000	1,5	1,5	108,5	-	-	84,5	1,4	1,05
NU213-E-TVP2	6.200	5.000	1,5	1,5	-	78,5	104,3	-	1,4	1,04
NU2213-E-TVP2	6.200	5.000	1,5	1,5	-	78,5	104,3	-	1,9	1,41
N313-E-TVP2	5.000	4.000	2,1	2,1	124,5	-	-	90,7	1,4	2,25
NU313-E-TVP2	5.000	4.000	2,1	2,1	-	82,5	118,5	-	1,5	2,25
NU2313-E-TVP2	5.000	4.000	2,1	2,1	-	82,5	118,6	-	4	3,3
NU413-M	7.000	5.600	2,1	2,1	-	89,3	125	-	3,5	3,9
NU1014-M	10.000	8.200	1,1	1	-	80	96	-	2,5	0,69
N214-E-TVP2	5.300	4.400	1,5	1,5	113,5	-	-	89,6	1,6	1,15
NU214-E-TVP2	5.300	4.400	1,5	1,5	-	83,5	108,7	-	1,6	1,15
NU2214-E-TVP2	5.300	4.400	1,5	1,5	-	83,5	108,7	-	1,6	1,5
N314-E-TVP2	4.500	3.600	2,1	2,1	133	-	-	97,5	1,6	2,76
NU314-E-TVP2	4.500	3.600	2,1	2,1	-	89	126,4	-	1,7	2,76
NU2314-E-TVP2	4.500	3.600	2,1	2,1	-	89	126,4	-	4,7	4
NU414-M	6.400	5.100	3	3	-	100	141	-	4	5,8
NU1015-M	9.600	7.900	1,1	1	-	85	101,5	-	2,5	0,74
N215-E-TVP2	5.300	4.200	1,5	1,5	118,5	-	-	94,5	1,1	1,25
NU215-E-TVP2	5.300	4.200	1,5	1,5	-	88,5	114	-	1,2	1,25
NU2215-E-TVP2	5.300	4.200	1,5	1,5	-	88,5	113,5	-	1,6	1,6
N315-E-TVP2	4.000	3.200	2,1	2,1	143	-	-	104,1	1,1	3,3
NU315-E-TVP2	4.000	3.200	2,1	2,1	-	95	136,2	-	1,2	3,3

\*Dimensiones en mm. / \* Dimensions in mm.

\*\*Masa en kg. / \*\* Mass in kg.



## 2.1.1 Rodamientos de una hilera de rodillos cilíndricos con jaula Single row cylindrical roller bearings with cage

### RODAMIENTOS LIBRES / NON-LOCATING BEARINGS

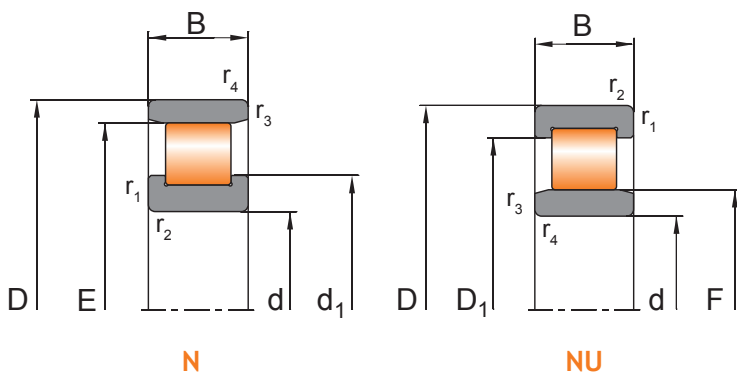

DIMENSIONES* BOUNDARY DIMENSIONS*			DESIGNACION DESIGNATION	$\epsilon^*$	CAPACIDAD DE CARGA (kN) LOAD RATING (kN)			CARGA LIMITE DE FATIGA (kN) FATIGUE LIMIT LOAD (kN)	
d	D	B			dyn. Cr	dyn. $\epsilon^*$ Cr $\epsilon^*$	stat. Cor	Cu	
75	160	55	NU2315-E-TVP2	$\epsilon^*$	365	388	397	52	
	190	45	NU415-M	-	315	-	291	37	
80	125	22	NU1016-M	-	83	-	96	11,4	
	140	26	N216-E-TVP2	$\epsilon^*$	154	161	166	22,3	
	140	26	NU216-E-TVP2	$\epsilon^*$	154	161	166	22,3	
	140	33	NU2216-E-TVP2	$\epsilon^*$	206	218	244	37	
	170	39	N316-E-TVP2	$\epsilon^*$	286	300	280	37	
	170	39	NU316-E-TVP2	$\epsilon^*$	286	300	280	37	
	170	58	NU2316-E-TVP2	$\epsilon^*$	393	418	440	56,1	
	200	48	NU416-M	-	380	-	355	55	
85	130	22	NU1017-M	-	90	-	99	13,5	
	150	28	N217-E-TVP2	$\epsilon^*$	181	191	198	25	
	150	28	NU217-E-TVP2	$\epsilon^*$	181	191	198	25	
	150	36	NU2217-E-TVP2	$\epsilon^*$	241	254	278	45,5	
	180	41	N317-E-M1	$\epsilon^*$	323	340	328	41	
	180	41	NU317-E-TVP2	$\epsilon^*$	323	340	328	41	
	180	60	NU2317-E-TVP2	$\epsilon^*$	426	446	456	69,9	
	210	52	NU417-M	-	410	-	370	57	
90	140	24	NU1018-M	-	105	-	120	16	
	160	30	N218-E-TVP2	$\epsilon^*$	200	211	219	28	
	160	30	NU218-E-TVP2	$\epsilon^*$	200	211	219	28	
	160	40	NU2218-E-TVP2	$\epsilon^*$	267	283	315	50	
	190	43	N318-E-M1	$\epsilon^*$	349	365	353	44	
	190	43	NU318-E-TVP2	$\epsilon^*$	349	365	353	44	
	190	64	NU2318-E-TVP2	$\epsilon^*$	480	500	530	72,6	
	225	54	NU418-M	-	450	-	420	64,4	
95	145	24	NU1019-M	-	110	-	125	16,5	
	170	32	N219-E-TVP2	$\epsilon^*$	245	255	265	33	
	170	32	NU219-E-TVP2	$\epsilon^*$	245	255	265	33	
	170	43	NU2219-E-TVP2	$\epsilon^*$	317	330	373	57,6	
	200	45	N319-E-M1	$\epsilon^*$	373	390	386	47,5	
	200	45	NU319-E-TVP2	$\epsilon^*$	373	390	386	47,5	

\*Dimensiones en mm. / \* Dimensions in mm.

\*\*Masa en kg. / \*\* Mass in kg.

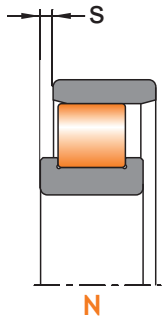

**NU**  
Axial Displacement (s)

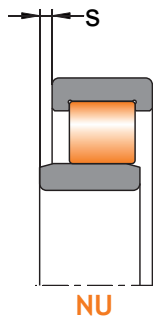

**N**  
Axial Displacement (s)

DESIGNACIÓN DESIGNATION	VELOCIDADES LIMITE SPEED RATINGS (rpm)		$r_1, r_2$ (min)	$r_3, r_4$ (min)	DIMENSIONES SECUNDARIAS SECONDARY DIMENSIONS					MASA** MASS**
	ng aceite ng oil	ng grasa ng grease			E	F	$D_i$	$d_i$	s	
NU2315-E-TVP2	4.000	3.200	2,1	2,1	-	95	136,2	-	4,2	4,9
NU415-M	6.000	4.800	3	3	-	104,5	150,7	-	4,5	6,9
NU1016-M	9.100	7.400	1,1	1	-	91,5	109,6	-	2,7	1
N216-E-TVP2	5.000	4.100	2	2	127,3	-	-	101,7	1,2	1,6
NU216-E-TVP2	5.000	4.100	2	2	-	95,3	122,3	-	1,3	1,6
NU2216-E-TVP2	5.000	4.100	2	2	-	95,3	122,3	-	1,3	2
N316-E-TVP2	3.900	3.200	2,1	2,1	151	-	-	110,4	0,6	4
NU316-E-TVP2	3.900	3.200	2,1	2,1	-	101	143,9	-	0,7	4
NU2316-E-TVP2	3.900	3.200	2,1	2,1	-	101	143,9	-	3,7	5,9
NU416-M	5.500	4.400	3	3	-	110	159,7	-	4,6	8,3
NU1017-M	9.000	7.400	1,1	1	-	96,5	114,8	-	4	1
N217-E-TVP2	4.800	3.800	2	2	136,5	-	-	107,6	0,7	1,9
NU217-E-TVP2	4.800	3.800	2	2	-	100,5	131	-	0,8	1,9
NU2217-E-TVP2	4.800	3.800	2	2	-	100,5	131	-	1,3	2,5
N317-E-M1	3.800	3.000	3	3	160	-	-	118	1,1	5
NU317-E-TVP2	3.800	3.000	3	3	-	108	152,4	-	1,3	4,7
NU2317-E-TVP2	3.800	3.000	3	3	-	108	152,7	-	4,7	6,7
NU417-M	5.000	4.000	4	4	-	113	165,7	-	5,2	9,8
NU1018-M	8.500	7.000	1,5	1,1	-	103	122,9	-	3	1,3
N218-E-TVP2	4.500	3.600	2	2	145	-	-	114,5	1,4	2,3
NU218-E-TVP2	4.500	3.600	2	2	-	107	139,5	-	1,5	2,3
NU2218-E-TVP2	4.500	3.600	2	2	-	107	139,5	-	2,5	3,2
N318-E-M1	3.600	2.900	3	3	169,5	-	-	124	1,3	6
NU318-E-TVP2	3.600	2.900	3	3	-	113,5	159,4	-	1,5	5,3
NU2318-E-TVP2	3.600	2.900	3	3	-	113,5	161,6	-	5	8
NU418-M	4.800	4.000	4	4	-	123,5	179,7	-	5	11,7
NU1019-M	8.000	6.500	1,5	1,1	-	108	127,9	-	4,1	1,4
N219-E-TVP2	4.200	3.400	2,1	2,1	154,5	-	-	120,5	0,6	2,9
NU219-E-TVP2	4.200	3.400	2,1	2,1	-	112,5	148,6	-	0,7	2,9
NU2219-E-TVP2	4.200	3.400	2,1	2,1	-	112,5	148,5	-	2,2	3,9
N319-E-M1	3.600	2.900	3	3	177,5	-	-	132	1,4	6,9
NU319-E-TVP2	3.600	2.900	3	3	-	121,5	169,6	-	1,4	6,3

\*Dimensiones en mm. / \* Dimensions in mm.

\*\*Masa en kg. / \*\* Mass in kg.



## 2.1.1 Rodamientos de una hilera de rodillos cilíndricos con jaula Single row cylindrical roller bearings with cage

### RODAMIENTOS LIBRES / NON-LOCATING BEARINGS

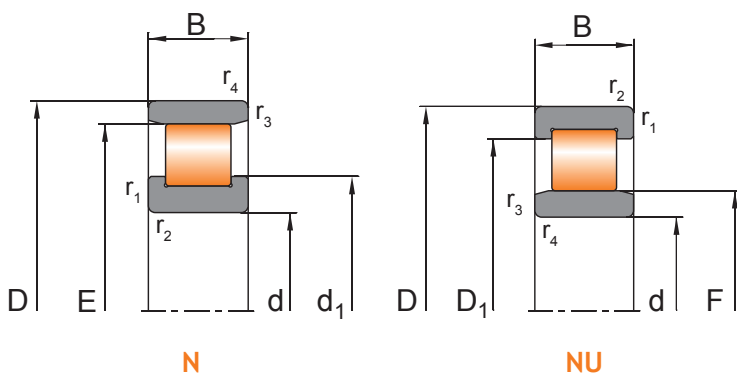

DIMENSIONES* BOUNDARY DIMENSIONS*			DESIGNACION DESIGNATION	$\epsilon^*$	CAPACIDAD DE CARGA (kN) LOAD RATING (kN)			CARGA LIMITE DE FATIGA (kN) FATIGUE LIMIT LOAD (kN)
d	D	B			dyn. Cr	dyn. $\epsilon^*$ Cr $\epsilon^*$	stat. Cor	Cu
95	200	67	NU2319-E-TVP2	$\epsilon^*$	510	540	585	89
	240	55	NU419-M	-	480	-	465	72
100	150	24	NU1020-M	-	114	-	130	16,7
	180	34	N220-E-TVP2	$\epsilon^*$	280	293	305	38
	180	34	NU220-E-TVP2	$\epsilon^*$	280	293	305	38
	180	46	NU2220-E-TVP2	$\epsilon^*$	367	384	446	65,2
	215	47	N320-E-M1	$\epsilon^*$	428	450	433	53
	215	47	NU320-E-TVP2	$\epsilon^*$	428	450	433	53
	215	73	NU2320-E-TVP2	$\epsilon^*$	640	675	730	105
	250	58	NU420-M	-	540	-	520	74
105	160	26	NU1021-M	-	126	-	147	17,4
	190	36	N221-E-M1	$\epsilon^*$	295	307	316	39,5
	190	36	NU221-E-TVP2	$\epsilon^*$	295	307	316	39,5
	225	49	N321-E-TVP2	$\epsilon^*$	473	500	500	57
	225	49	NU321-E-TVP2	$\epsilon^*$	473	500	500	57
	260	60	NU421-M	-	605	-	590	70
110	170	28	NU1022-M	-	156	-	185	21,4
	200	38	N222-E-TVP2	$\epsilon^*$	319	338	365	50
	200	38	NU222-E-TVP2	$\epsilon^*$	319	338	365	50
	200	53	NU2222-E-TVP2	$\epsilon^*$	426	449	520	80,8
	240	50	N322-E-M1	$\epsilon^*$	500	530	515	60
	240	50	NU322-E-TVP2	$\epsilon^*$	500	530	515	60
	240	80	NU2322-E-TVP2	$\epsilon^*$	730	760	835	116
	280	65	NU422-M	-	640	-	645	92,7
120	180	28	NU1024-M	-	166	-	195	24,9
	215	40	N224-E-TVP2	$\epsilon^*$	373	390	420	51
	215	40	NU224-E-TVP2	$\epsilon^*$	373	390	420	51
	215	58	NU2224-E-TVP2	$\epsilon^*$	499	530	615	95
	260	55	N324-E-M1	$\epsilon^*$	585	610	610	70
	260	55	NU324-E-TVP2	$\epsilon^*$	585	610	610	70
	260	86	NU2324-E-M1	$\epsilon^*$	890	930	1.030	140
310	72	NU424-M	-	800	-	770	95	

\*Dimensiones en mm. / \* Dimensions in mm.

\*\*Masa en kg. / \*\* Mass in kg.

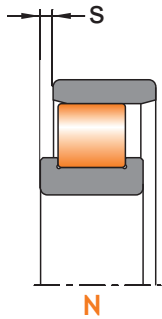

**N**  
Axial Displacement (s)

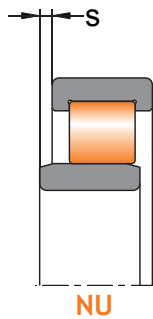

**NU**  
Axial Displacement (s)

DESIGNACIÓN DESIGNATION	VELOCIDADES LIMITE SPEED RATINGS (rpm)		$r_1, r_2$ (min)	$r_3, r_4$ (min)	DIMENSIONES SECUNDARIAS SECONDARY DIMENSIONS					MASA** MASS**
	ng aceite ng oil	ng grasa ng grease			E	F	$D_1$	$d_1$	s	
NU2319-E-TVP2	3.600	2.900	3	3	-	121,5	169,6	-	5,6	9,4
NU419-M	4.600	3.600	4	4	-	133,5	189,7	-	5,2	13,8
NU1020-M	7.500	6.200	1,5	1,1	-	113	132	-	4,3	1,5
N220-E-TVP2	4.000	3.300	2,1	2,1	163	-	-	130	1,4	3,5
NU220-E-TVP2	4.000	3.300	2,1	2,1	-	119	154,2	-	1,5	3,5
NU2220-E-TVP2	4.000	3.300	2,1	2,1	-	119	154,8	-	2,5	4,8
N320-E-M1	3.500	2.800	3	3	191,5	-	-	139,4	1,2	8,5
NU320-E-TVP2	3.500	2.800	3	3	-	127,5	182	-	1,2	7,6
NU2320-E-TVP2	3.500	2.800	3	3	-	127,5	178,7	-	4,2	12,1
NU420-M	4.500	3.600	4	4	-	139	198,2	-	5,7	14,9
NU1021-M	7.100	5.800	2	1,1	-	119,5	140	-	4,5	1,9
N221-E-M1	3.900	3.100	2,1	2,1	171,5	-	-	134,2	1,2	4,5
NU221-E-TVP2	3.900	3.100	2,1	2,1	-	125,5	163,7	-	1,3	4
N321-E-TVP2	3.400	2.700	3	3	201	-	-	145	1,2	8,6
NU321-E-TVP2	3.400	2.700	3	3	-	133	190	-	1,2	8,6
NU421-M	4.300	3.500	4	4	-	144,5	207,4	-	5,7	17,3
NU1022-M	7.000	5.600	2	1,1	-	125	149	-	3,2	2,3
N222-E-TVP2	3.600	2.900	2,1	2,1	180,5	-	-	141,6	1,4	4,8
NU222-E-TVP2	3.600	2.900	2,1	2,1	-	132,5	174,6	-	1,5	4,8
NU2222-E-TVP2	3.600	2.900	2,1	2,1	-	132,5	174,6	-	4	6,7
N322-E-M1	3.300	2.600	3	3	211	-	-	155,6	1,3	11,5
NU322-E-TVP2	3.300	2.600	3	3	-	143	201,7	-	1,3	10,3
NU2322-E-TVP2	3.300	2.600	3	3	-	143	200,9	-	5,8	16,7
NU422-M	4.000	3.300	4	4	-	155	217	-	6,2	22,4
NU1024-M	6.300	5.000	2	1,1	-	135	159	-	3,2	2,5
N224-E-TVP2	3.400	2.700	2,1	2,1	195,5	-	-	153	1,4	5,8
NU224-E-TVP2	3.400	2.700	2,1	2,1	-	143,5	188	-	1,4	5,8
NU2224-E-TVP2	3.400	2.700	2,1	2,1	-	143,5	187,8	-	4,5	8,4
N324-E-M1	3.000	2.400	3	3	230	-	-	168,2	3,5	14,9
NU324-E-TVP2	3.000	2.400	3	3	-	154	218,7	-	3,5	13,3
NU2324-E-M1	3.900	3.300	3	3	-	154	218,7	-	7,2	23,3
NU424-M	3.600	2.900	5	5	-	170	243,9	-	6,9	29,2

\*Dimensiones en mm. / \* Dimensions in mm.

\*\*Masa en kg. / \*\* Mass in kg.



## 2.1.1 Rodamientos de una hilera de rodillos cilíndricos con jaula Single row cylindrical roller bearings with cage

### RODAMIENTOS LIBRES / NON-LOCATING BEARINGS

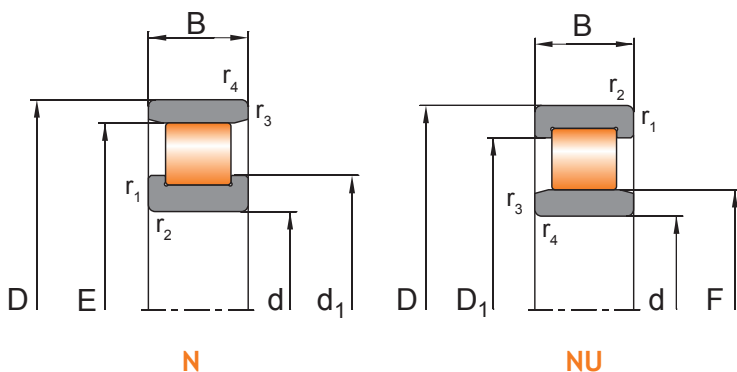

DIMENSIONES* BOUNDARY DIMENSIONS*			DESIGNACION DESIGNATION	$\epsilon^*$	CAPACIDAD DE CARGA (kN) LOAD RATING (kN)			CARGA LIMITE DE FATIGA (kN) FATIGUE LIMIT LOAD (kN)
d	D	B			dyn. Cr	dyn. $\epsilon^*$ Cr $\epsilon^*$	stat. Cor	Cu
130	200	33	NU1026-M	-	200	-	229	29,5
	230	40	N226-E-TVP2	$\epsilon^*$	400	423	447	53,6
	230	40	NU226-E-TVP2	$\epsilon^*$	400	423	447	53,6
	230	64	NU2226-E-TVP2	$\epsilon^*$	590	620	735	100
	280	58	N326-E-M1	$\epsilon^*$	680	710	690	79,3
	280	58	NU326-E-TVP2	$\epsilon^*$	680	710	690	79,3
	280	93	NU2326-E-M1	$\epsilon^*$	1.020	1070	1.240	160
140	210	33	NU1028-M	-	215	-	260	32
	250	42	N228-E-M1	$\epsilon^*$	435	460	510	58,6
	250	42	NU228-E-M1	$\epsilon^*$	435	460	510	58,6
	250	68	NU2228-E-M1	$\epsilon^*$	630	670	830	118
	300	62	N328-E-M1	$\epsilon^*$	755	790	815	90,4
	300	62	NU328-E-TVP2	$\epsilon^*$	755	790	815	90,4
	300	102	NU2328-E-M1	$\epsilon^*$	1.150	1.210	1.400	190
150	225	35	NU1030-M	-	238	-	290	35
	270	45	N230-E-M1	$\epsilon^*$	490	515	595	67
	270	45	NU230-E-M1	$\epsilon^*$	490	515	595	67
	270	73	NU2230-E-M1	$\epsilon^*$	715	750	950	130
	320	65	N330-E-M1	$\epsilon^*$	860	900	935	100
	320	65	NU330-E-M1	$\epsilon^*$	860	900	935	100
	320	108	NU2330-E-M1	$\epsilon^*$	1.300	1.380	1.620	207
160	240	38	NU1032-M	-	276	-	340	41
	290	48	N232-E-M1	$\epsilon^*$	560	585	670	74
	290	48	NU232-E-M1	$\epsilon^*$	560	585	670	74
	290	80	NU2232-E-M1	$\epsilon^*$	890	935	1.180	142
	340	68	N332-E-M1	$\epsilon^*$	900	950	1.060	110
	340	68	NU332-E-M1	$\epsilon^*$	900	950	1.060	110
	340	114	NU2332-E-M1	$\epsilon^*$	1.240	1.300	1.790	210
170	260	42	NU1034-M	-	335	-	425	48,5
	310	52	N234-E-M1	$\epsilon^*$	660	700	785	85,5
	310	52	NU234-E-M1	$\epsilon^*$	660	700	785	85,5
	310	86	NU2234-E-M1	$\epsilon^*$	1.010	1.070	1.370	170

\*Dimensiones en mm. / \* Dimensions in mm.

\*\*Masa en kg. / \*\* Mass in kg.

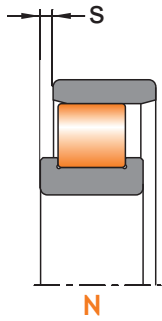

NU  
Axial Displacement (s)

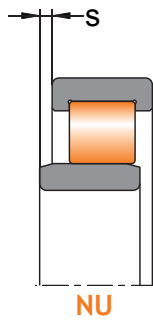

NU  
Axial Displacement (s)

DESIGNACIÓN DESIGNATION	VELOCIDADES LIMITE SPEED RATINGS (rpm)		$r_1, r_2$ (min)	$r_3, r_4$ (min)	DIMENSIONES SECUNDARIAS SECONDARY DIMENSIONS					MASA** MASS**
	ng aceite ng oil	ng grasa ng grease			E	F	$D_1$	$d_1$	s	
NU1026-M	5.600	4.500	2	1,1	-	148	175	-	3,9	3,8
N226-E-TVP2	3.200	2.600	3	3	209,5	-	-	164	1,2	6,5
NU226-E-TVP2	3.200	2.600	3	3	-	153,5	201,2	-	1,2	6,5
NU2226-E-TVP2	3.200	2.600	3	3	-	153,5	201,2	-	5,2	10,3
N326-E-M1	2.800	2.200	4	4	247	-	-	181,7	3,5	18
NU326-E-TVP2	2.800	2.200	4	4	-	167	235,2	-	3,5	16,1
NU2326-E-M1	3.700	3.000	4	4	-	167	235,2	-	8,1	28,9
NU1028-M	5.300	4.400	2	1,1	-	158	185,2	-	3,8	3,9
N228-E-M1	4.500	3.600	3	3	225	-	-	179,4	2	9,3
NU228-E-M1	4.500	3.600	3	3	-	169	216,7	-	2	9,3
NU2228-E-M1	4.500	3.600	3	3	-	169	216,7	-	7	15
N328-E-M1	2.600	2.100	4	4	264	-	-	195,4	5,2	22
NU328-E-TVP2	2.600	2.100	4	4	-	180	251,7	-	5,2	20,1
NU2328-E-M1	3.600	3.000	4	4	-	180	251,7	-	9,2	36,8
NU1030-M	5.000	4.100	2,1	1,5	-	169,5	199	-	4,2	4,9
N230-E-M1	4.200	3.300	3	3	242	-	-	193,7	4	11,8
NU230-E-M1	4.200	3.300	3	3	-	182	233,2	-	4	11,8
NU2230-E-M1	4.200	3.300	3	3	-	182	233,2	-	7,5	18,5
N330-E-M1	3.400	2.700	4	4	283	-	-	209,5	5,5	26,6
NU330-E-M1	3.400	2.700	4	4	-	193	269,8	-	5,5	26,6
NU2330-E-M1	3.300	2.700	4	4	-	193	268,4	-	9,7	44,7
NU1032-M	4.800	4.000	2,1	1,5	-	180	212,9	-	4,3	5,9
N232-E-M1	4.000	3.200	3	3	259	-	-	206,8	4,1	14,5
NU232-E-M1	4.000	3.200	3	3	-	195	249,6	-	4,1	14,5
NU2232-E-M1	3.600	3.000	3	3	-	193	251,1	-	7,2	24
N332-E-M1	2.800	2.200	4	4	300	-	-	221,6	5,5	32
NU332-E-M1	2.800	2.200	4	4	-	204	286	-	5,6	32
NU2332-E-M1	2.800	2.200	4	4	-	204	286	-	9,9	52,4
NU1034-M	4.400	3.600	2,1	2,1	-	193	229,1	-	4,8	8
N234-E-M1	3.400	2.800	4	4	279	-	-	218,4	4,3	18
NU234-E-M1	3.400	2.800	4	4	-	207	268,5	-	4,3	18,1
NU2234-E-M1	3.200	2.600	4	4	-	205	269,9	-	7,2	29,4

\*Dimensiones en mm. / \* Dimensions in mm.

\*\*Masa en kg. / \*\* Mass in kg.



## 2.1.1 Rodamientos de una hilera de rodillos cilíndricos con jaula Single row cylindrical roller bearings with cage

### RODAMIENTOS LIBRES / NON-LOCATING BEARINGS

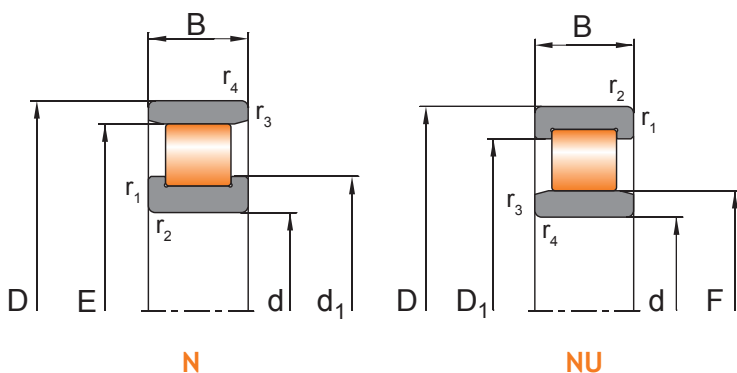

DIMENSIONES* BOUNDARY DIMENSIONS*			DESIGNACION DESIGNATION	$\epsilon^*$	CAPACIDAD DE CARGA (kN) LOAD RATING (kN)			CARGA LIMITE DE FATIGA (kN) FATIGUE LIMIT LOAD (kN)
d	D	B			dyn. Cr	dyn. $\epsilon^*$ Cr $\epsilon^*$	stat. Cor	Cu
170	360	72	N334-E-M1	$\epsilon^*$	910	960	1.190	113
	360	72	NU334-E-M1	$\epsilon^*$	910	960	1.190	113
	360	120	NU2334-E-M1	$\epsilon^*$	1.420	1.490	2.060	226
180	280	46	NU1036-M	-	402	-	486	58,6
	320	52	N236-E-M1	$\epsilon^*$	685	720	835	90
	320	52	NU236-E-M1	$\epsilon^*$	685	720	835	90
	320	86	NU2236-E-M1	$\epsilon^*$	1.100	1.150	1.440	195
	380	75	NU336-E-M1	$\epsilon^*$	975	1.040	1.310	117
	380	126	NU2336-E-M1	$\epsilon^*$	1.580	1.660	2.280	250
190	290	46	NU1038-M	-	420	-	540	60
	340	55	N238-E-M1	$\epsilon^*$	705	735	935	86,8
	340	55	NU238-E-M1	$\epsilon^*$	705	735	935	86,8
	340	92	NU2238-E-M1	$\epsilon^*$	1.050	1.100	1.620	180
	400	78	NU338-E-M1	$\epsilon^*$	1.070	1.120	1.450	122
	400	132	NU2338-E-M1	$\epsilon^*$	1.800	1.880	2.600	269
200	310	51	NU1040-M	-	460	-	585	64
	360	58	N240-E-M1	$\epsilon^*$	730	760	1.030	94,8
	360	58	NU240-E-M1	$\epsilon^*$	730	760	1.030	94,8
	360	98	NU2240-E-M1	$\epsilon^*$	1.180	1.250	1.830	190
	420	80	NU340-E-M1	$\epsilon^*$	1.150	1.200	1.580	132
	420	138	NU2340-E-M1	$\epsilon^*$	1.910	2.010	2.800	300
220	340	56	NU1044-M	-	505	-	750	71
	400	65	NU244-E-M1	$\epsilon^*$	955	1.000	1.300	113
	400	108	NU2244-E-M1	$\epsilon^*$	1.550	1.620	2.300	224
	460	88	NU344-E-M1	$\epsilon^*$	1.360	1.430	1.900	152
	460	145	NU2344-E-M1	$\epsilon^*$	2.260	2.360	3.400	336
	300	48	NU2944-M1	-	450	-	810	80
240	360	56	NU1048-M	-	535	-	840	75,4
	440	72	NU248-E-M1	$\epsilon^*$	1.070	1.120	1.490	131
	440	120	NU2248-E-M1	$\epsilon^*$	1.620	1.700	2.600	285
	500	95	NU348-E-M1	$\epsilon^*$	1.650	1.730	2.300	175
	500	155	NU2348-E-M1	$\epsilon^*$	2.460	2.600	3.700	370

\*Dimensiones en mm. / \* Dimensions in mm.

\*\*Masa en kg. / \*\* Mass in kg.



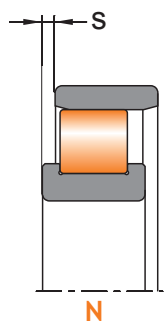

**NU**  
Axial Displacement (s)

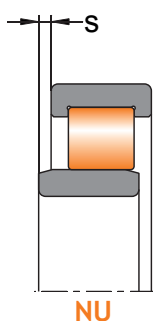

**N**  
Axial Displacement (s)

DESIGNACION DESIGNATION	VELOCIDADES LIMITE SPEED RATINGS (rpm)		$r_1, r_2$ (min)	$r_3, r_4$ (min)	DIMENSIONES SECUNDARIAS SECONDARY DIMENSIONS					MASA** MASS**
	ng aceite ng oil	ng grasa ng grease			E	F	$D_i$	$d_i$	s	
N334-E-M1	2.600	2.100	4	4	318	-	-	237	5,9	38
NU334-E-M1	2.600	2.100	4	4	-	218	301,6	-	6	38
NU2334-E-M1	2.800	2.300	4	4	-	216	269,9	-	10,2	61,8
NU1036-M	4.200	3.400	2,1	2,1	-	205	245,9	-	5	10,5
N236-E-M1	3.200	2.500	4	4	289	-	-	230,2	4,7	18,9
NU236-E-M1	3.200	2.500	4	4	-	217	278,6	-	4,7	18,9
NU2236-E-M1	3.200	2.500	4	4	-	215	280	-	7,2	30,8
NU336-E-M1	2.600	2.100	4	4	-	231	319,8	-	6,1	44
NU2336-E-M1	2.800	2.300	4	4	-	227	280	-	10,5	71,7
NU1038-M	3.900	3.200	2,1	2,1	-	215	255,9	-	5	10,9
N238-E-M1	3.000	2.400	4	4	306	-	-	244	4,7	23
NU238-E-M1	3.000	2.400	4	4	-	230	295	-	4,7	23
NU2238-E-M1	3.000	2.400	4	4	-	228	296,4	-	8	38,2
NU338-E-M1	2.500	2.100	5	5	-	245	336	-	6,3	50,2
NU2338-E-M1	2.600	2.100	5	5	-	240	296,4	-	11	82,9
NU1040-M	3.500	2.900	2,1	2,1	-	229	271,5	-	8,3	14,3
N240-E-M1	2.900	2.300	4	4	323	-	-	257,6	4,8	28
NU240-E-M1	2.900	2.300	4	4	-	243	311,5	-	4,8	28
NU2240-E-M1	2.900	2.300	4	4	-	241	312,9	-	8,2	45,3
NU340-E-M1	2.400	2.000	5	5	-	258	351,8	-	6,3	57,4
NU2340-E-M1	2.400	2.000	5	5	-	253	356,9	-	11,3	96,5
NU1044-M	3.000	2.400	3	3	-	250	298,9	-	6,2	20,2
NU244-E-M1	2.600	2.100	4	4	-	268	344,9	-	5,5	38,5
NU2244-E-M1	2.600	2.100	4	4	-	259	349,4	-	8,4	61,7
NU344-E-M1	2.200	1.800	5	5	-	282	386	-	7	75,5
NU2344-E-M1	2.200	1.800	5	5	-	277	391,2	-	11,9	120
NU2944-M1	3.200	2.500	2,1	2,1	-	242	270	-	3	10
NU1048-M	2.800	2.300	3	3	-	270	318,9	-	6,4	20
NU248-E-M1	2.400	1.900	4	4	-	293	376,6	-	6	51,8
NU2248-E-M1	2.400	1.900	4	4	-	287	380,7	-	10,2	83,1
NU348-E-M1	2.000	1.600	5	5	-	306	421,2	-	7,4	95,7
NU2348-E-M1	2.000	1.600	5	5	-	303	424	-	13,3	152

\*Dimensiones en mm. / \* Dimensions in mm.

\*\*Masa en kg. / \*\* Mass in kg.



## 2.1.1 Rodamientos de una hilera de rodillos cilíndricos con jaula Single row cylindrical roller bearings with cage

### RODAMIENTOS LIBRES / NON-LOCATING BEARINGS

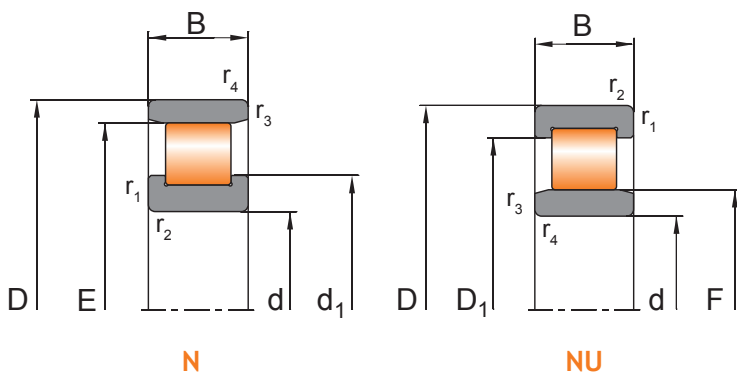

DIMENSIONES* BOUNDARY DIMENSIONS*			DESIGNACION DESIGNATION	$\epsilon^*$	CAPACIDAD DE CARGA (kN) LOAD RATING (kN)			CARGA LIMITE DE FATIGA (kN) FATIGUE LIMIT LOAD (kN)
d	D	B			dyn. Cr	dyn. $\epsilon^*$ Cr $\epsilon^*$	stat. Cor	
260	400	65	NU1052-M	-	630	-	975	98
	480	80	NU252-E-M1	$\epsilon^*$	1.210	1.280	1.790	155
	480	130	NU2252-E-M1	$\epsilon^*$	1.900	2.000	3.100	330
	540	102	NU352-E-M1	$\epsilon^*$	1.820	1.900	2.600	200
	540	165	NU2352-E-M1	$\epsilon^*$	2.920	3.100	4.500	430
280	420	65	NU1056-M	-	670	-	1.080	100
	500	80	NU256-E-M1	$\epsilon^*$	1.300	1.380	1.880	160
	500	130	NU2256-E-M1	$\epsilon^*$	2.080	2.200	3.400	355
	580	108	NU356-E-M1	$\epsilon^*$	1.980	2.100	3.000	220
	580	175	NU2356-E-M1	$\epsilon^*$	3.260	3.400	5.000	480
300	460	74	NU1060-M	-	880	-	1.410	130
	540	85	NU260-E-M1	$\epsilon^*$	1.230	1.500	2.220	183
	540	140	NU2260-E-M1	$\epsilon^*$	2.260	2.400	3.700	385
320	400	38	NU1864-E-M1	$\epsilon^*$	340	370	685	60
	480	74	NU1064-M	-	905	-	1.450	128
	580	92	NU264-E-M1	$\epsilon^*$	1.600	1.700	1.650	204
	580	150	NU2264-E-M1	$\epsilon^*$	2.990	3.160	4.900	450
340	420	38	NU1868-E-M1	$\epsilon^*$	360	375	730	60
	460	72	NU2968-M	-	850	-	1.800	170
	520	82	NU1068-M	-	1.080	-	1.750	158
	620	92	NU268-E-M1	$\epsilon^*$	1.850	1.950	300	240
	620	165	NU2268-E-M1	$\epsilon^*$	3.100	3.300	5.400	500
360	440	38	NU1872-E-M1	$\epsilon^*$	365	380	760	62
	540	82	NU1072-M	-	1.120	-	1.880	155
	650	170	NU2272-E-M1	$\epsilon^*$	3.340	3.600	5.600	510
380	480	46	NU1876-M	-	490	-	960	88
	560	82	NU1076-M	-	1.160	-	1.970	170
	680	175	NU2276-E-M1	$\epsilon^*$	3.600	3.900	6.500	600
400	500	46	NU1880-M	-	520	-	1.100	88
	540	82	NU2980-M1	-	1.300	-	2.750	250
	600	90	NU1080-M	-	1.370	-	2.320	180
420	520	46	NU1884-M1	-	500	-	1.100	90

\*Dimensiones en mm. / \* Dimensions in mm.

\*\*Masa en kg. / \*\* Mass in kg.

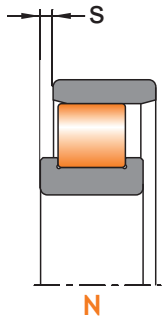

**N**  
Axial Displacement (s)

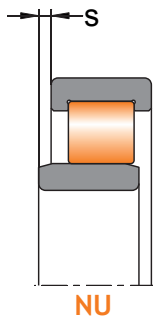

**NU**  
Axial Displacement (s)

DESIGNACIÓN DESIGNATION	VELOCIDADES LIMITE SPEED RATINGS (rpm)		$r_1, r_2$ (min)	$r_3, r_4$ (min)	DIMENSIONES SECUNDARIAS SECONDARY DIMENSIONS					MASA** MASS**
	ng aceite ng oil	ng grasa ng grease			E	F	$D_i$	$d_i$	s	
NU1052-M	2.600	2.100	4	4	-	296	351,3	-	7,2	29,6
NU252-E-M1	2.200	1.800	5	5	-	317	410,8	-	6,2	68,4
NU2252-E-M1	2.200	1.800	5	5	-	313	413,6	-	10,5	109
NU352-E-M1	1.800	1.400	6	6	-	337	454,6	-	10	122
NU2352-E-M1	1.800	1.400	6	6	-	324	458,4	-	13,7	189
NU1056-M	2.500	2.100	4	4	-	316	371,3	-	7,2	31,4
NU256-E-M1	2.000	1.600	5	5	-	337	430,8	-	6,3	72,1
NU2256-E-M1	2.000	1.600	5	5	-	333	436	-	10,5	115
NU356-E-M1	1.700	1.400	6	6	-	362	488	-	8,7	147
NU2356-E-M1	1.700	1.400	6	6	-	351	493,8	-	13,8	232
NU1060-M	2.200	1.800	4	4	-	340	405,2	-	7,9	45,5
NU260-E-M1	1.900	1.500	5	5	-	364	464,6	-	6,9	90
NU2260-E-M1	1.900	1.500	5	5	-	355	472,6	-	12,2	144
NU1864-E-M1	2.700	2.000	2,1	1,5	-	341	373,8	-	4,3	11
NU1064-M	2.100	1.700	4	4	-	360	425,1	-	8	47,5
NU264-E-M1	1.800	1.500	5	5	-	392	499,4	-	7,5	115
NU2264-E-M1	1.600	1.300	5	5	-	380	506	-	11,9	180
NU1868-E-M1	2.700	2.000	2,1	1,5	-	361,5	394,7	-	4,3	11,5
NU2968-M	2.200	1.800	3	3	-	370	418	-	7	35
NU1068-M	1.900	1.500	5	5	-	385	458,2	-	8,9	65
NU268-E-M1	1.700	1.400	6	6	-	419	526,4	-	7,4	134
NU2268-E-M1	1.400	1.200	6	6	-	408	534	-	13,3	229
NU1872-E-M1	2.600	1.900	2,1	1,5	-	381,5	414,7	-	4,3	12
NU1072-M	1.800	1.500	5	5	-	405	478,1	-	8,9	67
NU2272-E-M1	1.400	1.100	6	6	-	428	562	-	15	254
NU1876-M	2.200	1.700	2,1	2,1	-	407,5	447,4	-	5,3	20
NU1076-M	1.800	1.400	5	5	-	425	498,1	-	9	70
NU2276-E-M1	1.400	1.100	6	6	-	451	588,8	-	13,8	288
NU1880-M	2.200	1.700	2,1	2,1	-	428	468	-	5,3	20
NU2980-M1	2.000	1.600	4	4	-	434	494	-	7,2	56
NU1080-M	1.700	1.300	5	5	-	450	531,5	-	9,5	90
NU1884-M1	2.000	1.600	2,1	2,1	-	448	488	-	5,3	21

\*Dimensiones en mm. / \* Dimensions in mm.

\*\*Masa en kg. / \*\* Mass in kg.



## 2.1.1 Rodamientos de una hilera de rodillos cilíndricos con jaula Single row cylindrical roller bearings with cage

### RODAMIENTOS LIBRES / NON-LOCATING BEARINGS

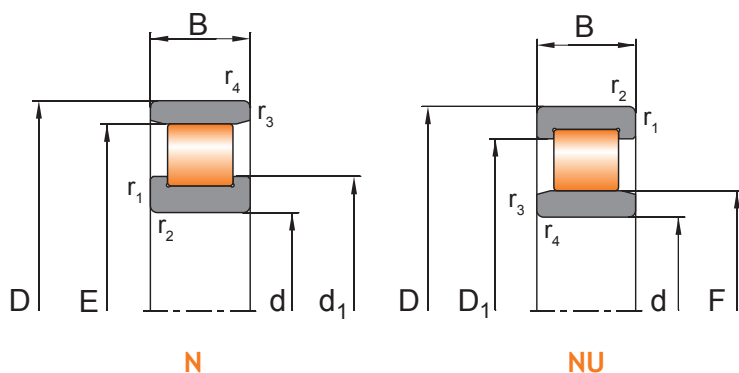

DIMENSIONES* BOUNDARY DIMENSIONS*			DESIGNACION DESIGNATION	$\epsilon^*$	CAPACIDAD DE CARGA (kN) LOAD RATING (kN)			CARGA LIMITE DE FATIGA (kN) FATIGUE LIMIT LOAD (kN)	
d	D	B			dyn. Cr	dyn. $\epsilon^*$ Cr $\epsilon^*$	stat. Cor	Cu	
420	560	82	NU2984-M1	-	1.350	-	2.850	270	
	620	90	NU1084-M	-	1.400	-	2.450	185	
440	650	94	NU1088-M	-	1.550	-	2.700	205	
460	620	74	NU1992-M	-	1.000	-	2.000	140	
	680	100	NU1092-M1	-	1.650	-	2.900	220	
	830	165	NU1292-M	-	4.500	-	6.800	550	
480	600	56	NU1896-M	-	690	-	1.500	120	
	650	78	NU1996-M	-	1.150	-	2.200	185	
	700	100	NU1096-M1	-	1.700	-	3.100	230	
500	670	128	NU39/500-M1	-	2.300	-	5.300	500	
	920	185	NU12/500-M1	-	5.300	-	8.400	630	
530	710	106	NU29/530-E-M1	$\epsilon^*$	2.200	2.350	4.900	415	
560	750	85	NU19/560-E-M	$\epsilon^*$	1.450	1.550	3.000	220	
	750	112	NU29/560-E-M1	$\epsilon^*$	2.400	2.500	5.400	460	
	1.030	206	NU12/560-M1	-	7.100	-	10.100	800	
600	730	60	NU18/600-M	-	840	-	1.900	150	
	800	90	NU19/600-E-M1	$\epsilon^*$	1.700	1.850	3.500	270	
	800	118	NU29/600-E-M1	$\epsilon^*$	2.850	3.000	6.600	550	
630	780	88	N28/630-M	-	1.600	-	4.000	350	
	780	112	N38/630-M1	-	2.000	-	5.200	450	
	850	128	NU29/630-E-M1	$\epsilon^*$	3.000	3.300	7.300	500	
	1.150	230	NU12/630-E-M1	$\epsilon^*$	7.500	7.800	13.000	1.000	
670	900	103	NU19/670-E-M	$\epsilon^*$	2.000	2.200	4.500	300	
710	870	74	NU18/710-E-M	$\epsilon^*$	1.300	1.400	3.250	240	
	870	95	NU28/710-M	-	1.900	-	5.000	380	
	950	106	NU19/710-E-M	$\epsilon^*$	2.150	2.300	4.500	300	
	950	140	NU29/710-E-M1	$\epsilon^*$	3.500	3.700	8.400	700	
750	920	78	NU18/750-M	-	1.400	-	3.400	250	
850	1.030	106	NU28/850-M	-	2.200	-	6.700	450	
900	1.090	85	NU18/900-M	-	2.000	-	5.000	300	
	1.090	112	N28/900-M	-	2.500	-	6.900	490	
	1.180	165	NU29/900-E-M1	$\epsilon^*$	5.200	5.500	13.400	1.000	

\*Dimensiones en mm. / \* Dimensions in mm.

\*\*Masa en kg. / \*\* Mass in kg.

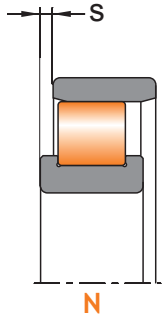

**N**  
Axial Displacement (s)

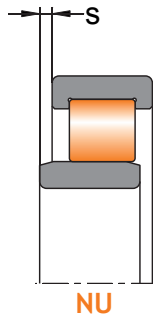

**NU**  
Axial Displacement (s)

DESIGNACION DESIGNATION	VELOCIDADES LIMITE SPEED RATINGS (rpm)		$r_1, r_2$ (min)	$r_3, r_4$ (min)	DIMENSIONES SECUNDARIAS SECONDARY DIMENSIONS					MASA** MASS**
	ng aceite ng oil	ng grasa ng grease			E	F	$D_i$	$d_i$	s	
NU2984-M1	1.800	1.500	4	4	-	454	511,6	-	6	59
NU1084-M	1.800	1.400	5	5	-	470	551,5	-	9,6	94
NU1088-M	1.600	1.300	6	6	-	493	577,6	-	9,8	108
NU1992-M	1.800	1.500	4	4	-	502	562,8	-	8,4	65
NU1092-M1	1.500	1.200	6	6	-	516	602,4	-	11,2	123
NU1292-M	1.100	900	7,5	7,5	-	539	724	-	14,1	405
NU1896-M	1.800	1.500	3	3	-	514	560,5	-	6,6	36
NU1996-M	1.600	1.300	5	5	-	525	589	-	6,8	75
NU1096-M1	1.500	1.200	6	6	-	536	623,9	-	10,7	130
NU39/500-M1	1.400	1.100	5	5	-	543	618	-	11	130
NU12/500-M1	1.000	800	7,5	7,5	-	589	799	-	16	570
NU29/530-E-M1	1.200	1.000	5	5	-	575	647	-	8,5	125
NU19/560-E-M	1.200	1.000	5	5	-	610	682	-	9,6	106
NU29/560-E-M1	1.200	1.000	5	5	-	607	687,5	-	6,5	142
NU12/560-M1	900	700	9,5	9,5	-	659	894	-	11,9	780
NU18/600-M	1.100	900	3	3	-	637	687	-	7	51
NU19/600-E-M1	1.000	800	5	5	-	652	730,7	-	9,9	125
NU29/600-E-M1	1.000	800	5	5	-	649	739	-	8,4	170
N28/630-M	1.100	900	4	4	744	-	-	684	8,7	95
N38/630-M1	800	600	4	4	744	-	-	683	11,2	120
NU29/630-E-M1	800	600	6	6	-	683	784	-	10,3	215
NU12/630-E-M1	800	600	15	15	-	760	978	-	20	1.100
NU19/670-E-M	900	700	6	6	-	731	817	-	11,3	190
NU18/710-E-M	900	700	4	4	-	753	820	-	7,9	93
NU28/710-M	900	700	4	4	-	753	820	-	8,7	130
NU19/710-E-M	900	700	6	6	-	774	867,7	-	9,3	215
NU29/710-E-M1	900	700	6	6	-	770	866	-	11,7	295
NU18/750-M	900	700	5	5	-	799	866	-	8,8	110
NU28/850-M	800	650	5	5	-	895	970	-	9,3	188
NU18/900-M	700	600	5	5	-	951	1031	-	11,8	165
N28/900-M	700	600	5	5	1.045	-	-	967	9,5	238
NU29/900-E-M1	700	600	6	6	-	970	1.088	-	13,3	500

\*Dimensiones en mm. / \* Dimensions in mm.

\*\*Masa en kg. / \*\* Mass in kg.



## 2.1.1 Rodamientos de una hilera de rodillos cilíndricos con jaula Single row cylindrical roller bearings with cage

### RODAMIENTOS LIBRES / NON-LOCATING BEARINGS

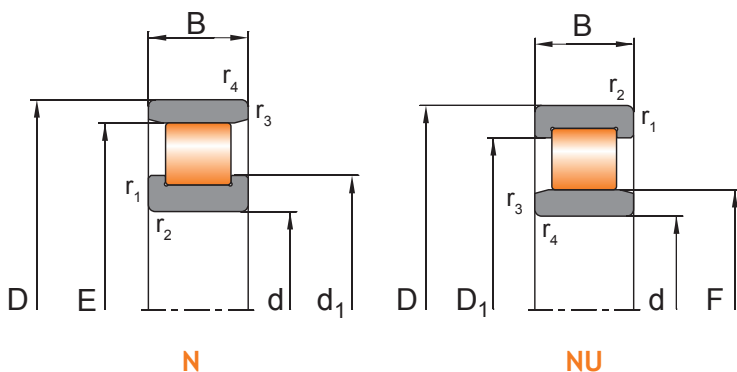

DIMENSIONES* BOUNDARY DIMENSIONS*			DESIGNACION DESIGNATION	$\epsilon^*$	CAPACIDAD DE CARGA (kN) LOAD RATING (kN)			CARGA LIMITE DE FATIGA (kN) FATIGUE LIMIT LOAD (kN)	
d	D	B			dyn. Cr	dyn. $\epsilon^*$ Cr $\epsilon^*$	stat. Cor	Cu	
950	1.250	175	NU29/950-E-M	$\epsilon^*$	5.700	5.900	14.000	1.050	
1.000	1.220	100	NU18/1000-M	-	2.400	-	5.800	410	
	1.320	185	NU29/1000-E-M	$\epsilon^*$	6.600	6.950	16.500	1.100	
1.060	1.280	128	NU28/1060-M	-	3.600	-	10.400	700	
	1.400	195	NU29/1060-E-M	$\epsilon^*$	7.000	7.300	18.000	1.100	
	1.500	325	N30/1060-M1	-	13.000	-	32.500	2.000	
1.180	1.540	206	NU29/1180-E-M	$\epsilon^*$	8.350	8.900	21.600	1.300	
	1.540	272	NU39/1180-M	-	10.100	-	28.000	1.700	
1.250	1.750	290	NU20/1250-M	-	12.800	-	30.000	1.800	
1.320	1.600	122	NU18/1320-M	-	3.500	-	10.000	600	
	1.720	230	NU29/1320-E-M	$\epsilon^*$	10.500	11.000	29.000	1.800	
	1.720	300	NU39/1320-M	-	12.000	-	34.000	2.000	
	1.850	400	N30/1320-M1	-	18.500	-	48.000	3.000	
1.400	1.700	175	N28/1400-M	-	6.200	-	17.500	940	
1.500	1.820	140	NU18/1500-M	-	5.000	-	13.800	780	
1.700	2.060	160	NU18/1700-E-M	$\epsilon^*$	6.600	7.250	19.000	1.050	

\*Dimensiones en mm. / \* Dimensions in mm.  
\*\*Masa en kg. / \*\* Mass in kg.

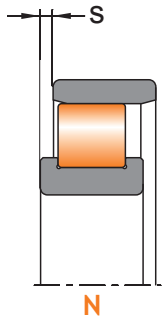

**N**

**Axial Displacement (s)**

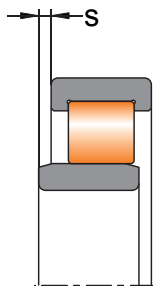

**NU**

**Axial Displacement (s)**

DESIGNACION DESIGNATION	VELOCIDADES LIMITE SPEED RATINGS (rpm)		$r_1, r_2$ (min)	$r_3, r_4$ (min)	DIMENSIONES SECUNDARIAS SECONDARY DIMENSIONS					MASA** MASS**
	ng aceite ng oil	ng grasa ng grease			E	F	$D_i$	$d_i$	s	
NU29/950-E-M	650	500	7,5	7,5	-	1.025	1.151	-	14,5	600
NU18/1000-M	600	500	6	6	-	1.058	1.150	-	10,3	245
NU29/1000-E-M	550	400	7,5	7,5	-	1.080	1.215	-	16,3	710
NU28/1060-M	500	400	6	6	-	1.118	1.210	-	11	345
NU29/1060-E-M	400	300	7,5	7,5	-	1.145	1.288	-	16,2	860
N30/1060-M1	300	200	9,5	9,5	1.390	-	-	1.206	29,8	1.950
NU29/1180-E-M	300	200	7,5	7,5	-	1.270	1.421	-	16,5	1.060
NU39/1180-M	300	150	7,5	7,5	-	1.270	1.432	-	13,9	1.375
NU20/1250-M	250	150	9,5	9,5	-	1.375	1.593	-	13,5	2.300
NU18/1320-M	350	200	6	6	-	1.397	1.511	-	12,8	500
NU29/1320-E-M	350	200	7,5	7,5	-	1.420	1.588	-	17,6	1.470
NU39/1320-M	350	200	7,5	7,5	-	1.420	1.600	-	14,9	1.900
N30/1320-M1	300	150	12	12	1.715	-	-	1.495	39	3.550
N28/1400-M	300	150	7,5	7,5	1.637	-	-	1.506	16,2	855
NU18/1500-M	300	150	7,5	7,5	-	1.585	1.719	-	14,5	750
NU18/1700-E-M	200	100	7,5	7,5	-	1.790	1.950	-	15,5	1.160

\*Dimensiones en mm. / \* Dimensions in mm.

\*\*Masa en kg. / \*\* Mass in kg.



## 2.1.2 Rodamientos de una hilera de rodillos cilíndricos con jaula Single row cylindrical roller bearings with cage

### RODAMIENTOS DE APOYO Y FIJOS / SEMI-LOCATING AND LOCATING BEARINGS

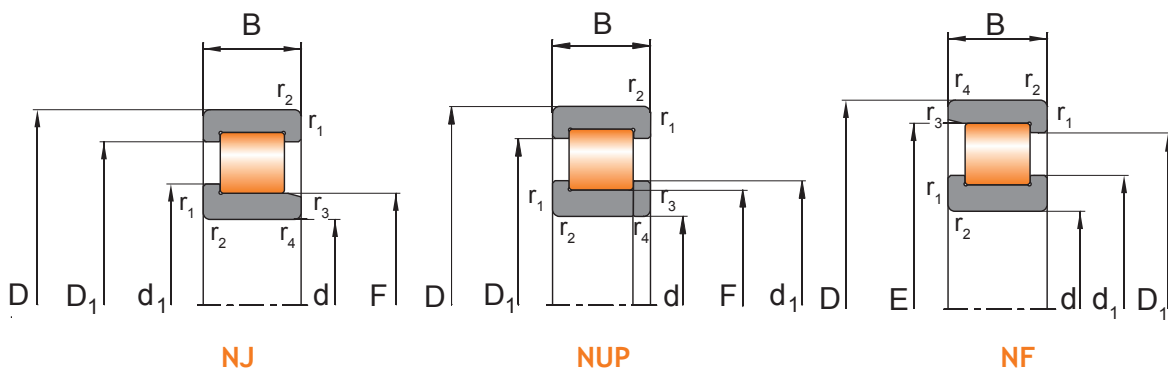

DIMENSIONES* BOUNDARY DIMENSIONS*			DESIGNACION DESIGNATION	E <sup>+</sup>	CAPACIDAD DE CARGA (kN) LOAD RATING (kN)			CARGA LÍMITE DE FATIGA / FATIGUE LIMIT LOAD (kN) Cu	VELOCIDADES LÍMITE SPEED RATINGS (rpm)	
d	D	B			dyn. Cr	dyn. E <sup>+</sup> Cr E <sup>+</sup>	stat. Cor		ng aceite ng oil	ng grasa ng grease
15	35	11	NJ202-E-TVP2	E <sup>+</sup>	13,2	14	10,3	1,25	22.000	17.700
17	40	12	NJ203-E-TVP2	E <sup>+</sup>	17,1	18,1	14,4	1,8	19.000	17.700
	40	12	NUP203-E-TVP2	E <sup>+</sup>	17,1	18,1	14,4	1,8	19.000	15.500
	40	16	NJ2203-E-TVP2	E <sup>+</sup>	25	26,5	21,8	3,4	19.000	15.500
	40	16	NUP2203-E-TVP2	E <sup>+</sup>	25	26,5	21,8	3,4	19.000	15.500
	47	14	NJ303-E-TVP2	E <sup>+</sup>	28,6	30	21	2,6	17.000	13.900
	47	14	NUP303-E-TVP2	E <sup>+</sup>	28,6	30	21	2,6	17.000	13.900
20	47	14	NJ204-E-TVP2	E <sup>+</sup>	28,8	30,1	22,6	3	17.000	13.600
	47	14	NUP204-E-TVP2	E <sup>+</sup>	28,8	30,1	22,6	3	17.000	13.600
	47	14	NF204-E-TVP2	E <sup>+</sup>	28,8	30,1	22,6	3	17.000	13.600
	47	18	NJ2204-E-TVP2	E <sup>+</sup>	36,4	38,1	29,2	4,4	17.000	13.600
	47	18	NUP2204-E-TVP2	E <sup>+</sup>	36,4	38,1	29,2	4,4	17.000	13.600
	52	15	NJ304-E-TVP2	E <sup>+</sup>	34,7	36,3	26	3,3	15.000	12.200
	52	15	NUP304-E-TVP2	E <sup>+</sup>	34,7	36,3	26	3,3	15.000	12.200
	52	21	NJ2304-E-TVP2	E <sup>+</sup>	45,7	48,0	38	5,8	15.000	12.200
	52	21	NUP2304-E-TVP2	E <sup>+</sup>	45,7	48,0	38	5,8	15.000	12.200
25	52	15	NJ205-E-TVP2	E <sup>+</sup>	31,8	33,3	27,1	3,5	16.000	13.000
	52	15	NUP205-E-TVP2	E <sup>+</sup>	31,8	33,3	27,1	3,5	16.000	13.000
	52	18	NJ2205-E-TVP2	E <sup>+</sup>	33,9	35,9	34,2	4,3	16.000	13.000
	52	18	NUP2205-E-TVP2	E <sup>+</sup>	33,9	35,9	34,2	4,3	16.000	13.000
	62	17	NJ305-E-TVP2	E <sup>+</sup>	45,1	47,1	36,5	4,6	13.000	10.300
	62	17	NUP305-E-TVP2	E <sup>+</sup>	45,1	47,1	36,5	4,6	13.000	10.300
	62	24	NJ2305-E-TVP2	E <sup>+</sup>	63,1	65,8	55	9	13.000	10.300
	62	24	NUP2305-E-TVP2	E <sup>+</sup>	63,1	65,8	55	9	13.000	10.300
30	62	16	NJ206-E-TVP2	E <sup>+</sup>	42,4	44,4	36,1	4,6	12.900	10.400
	62	16	NUP206-E-TVP2	E <sup>+</sup>	42,4	44,4	36,1	4,6	12.900	10.400
	62	20	NJ2206-E-TVP2	E <sup>+</sup>	53,3	56,4	49	7,9	12.900	10.400
	62	20	NUP2206-E-TVP2	E <sup>+</sup>	53,3	56,4	49	7,9	12.900	10.400
	72	19	NJ306-E-TVP2	E <sup>+</sup>	57,9	60,7	48	6,4	11.000	8.800
	72	19	NUP306-E-TVP2	E <sup>+</sup>	57,9	60,7	48	6,4	11.000	8.800
	72	27	NJ2306-E-TVP2	E <sup>+</sup>	79,5	83,2	75	10	11.000	8.800
	72	27	NUP2306-E-TVP2	E <sup>+</sup>	79,5	83,2	75	10	11.000	8.800

\*Dimensiones en mm. / \* Dimensions in mm.

\*\*Masa en kg. / \*\* Mass in kg.



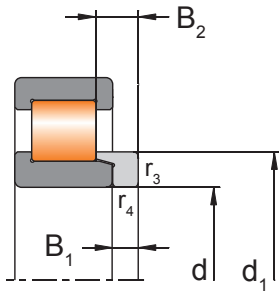

NJ + HJ

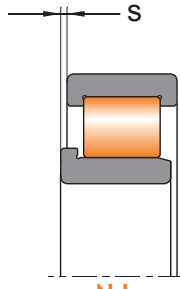

NJ

Axial Displacement (s)

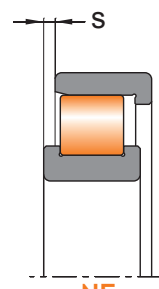

NF

Axial Displacement (s)

DESIGNACION DESIGNATION	r <sub>1</sub> , r <sub>2</sub> (min)	r <sub>3</sub> , r <sub>4</sub> (min)	DIMENSIONES SECUNDARIAS SECONDARY DIMENSIONS					MASA** MASS**	ANILLO ANGULAR THRUST COLLAR			
			E	F	D <sub>1</sub>	d <sub>1</sub>	s		Desig.	B <sub>1</sub>	B <sub>2</sub>	Masa** Mass**
NJ202-E-TVP2	0,6	0,3	-	19,3	28,1	21,7	0,5	0,048	HJ202-E	2,5	5	0,01
NJ203-E-TVP2	0,6	0,3	-	22,1	32,4	24,8	1,2	0,07	HJ203-E	3	5,5	0,01
NUP203-E-TVP2	0,6	0,3	-	22,1	32,4	24,8	-	0,072	-	-	-	-
NJ2203-E-TVP2	0,6	0,3	-	22,1	32,5	24,7	1,7	0,058	HJ2203-E	3	6	0,01
NUP2203-E-TVP2	0,6	0,3	-	22,1	32,5	24,7	-	0,6	-	-	-	-
NJ303-E-TVP2	1	0,6	-	24,2	37,1	27,6	1,2	0,12	HJ303-E	4	6,5	0,01
NUP303-E-TVP2	1	0,6	-	24,2	37,1	27,6	-	0,14	-	-	-	-
NJ204-E-TVP2	1	0,6	-	26,5	38,7	29,9	0,8	0,11	HJ204-E	3	5,5	0,01
NUP204-E-TVP2	1	0,6	-	26,5	38,7	29,9	-	0,12	-	-	-	-
NF204-E-TVP2	1	0,6	41,5	-	38,7	29,9	0,8	0,11	-	-	-	-
NJ2204-E-TVP2	1	0,6	-	26,5	38,7	29,9	1,8	0,15	HJ2204-E	3	6,5	0,01
NUP2204-E-TVP2	1	0,6	-	26,5	38,7	29,9	-	0,15	-	-	-	-
NJ304-E-TVP2	1,1	0,6	-	27,5	42,4	31,3	1	0,15	HJ304-E	4	6,5	0,02
NUP304-E-TVP2	1,1	0,6	-	27,5	42,4	31,3	-	0,16	-	-	-	-
NJ2304-E-TVP2	1,1	0,6	-	27,5	42,4	31,3	1,9	0,22	HJ2304-E	4	7,5	0,02
NUP2304-E-TVP2	1,1	0,6	-	27,5	42,4	31,3	-	0,23	-	-	-	-
NJ205-E-TVP2	1	0,6	-	31,5	43,8	34,7	1,3	0,14	HJ205-E	3	6	0,01
NUP205-E-TVP2	1	0,6	-	31,5	43,8	34,7	-	0,14	-	-	-	-
NJ2205-E-TVP2	1	0,6	-	31,5	43,8	34,7	1,7	0,17	HJ2205-E	3	6,5	0,02
NUP2205-E-TVP2	1	0,6	-	31,5	43,8	34,7	-	0,17	-	-	-	-
NJ305-E-TVP2	1,1	1,1	-	34	50,6	38,1	1,4	0,24	HJ305-E	4	7	0,03
NUP305-E-TVP2	1,1	1,1	-	34	50,6	38,1	-	0,25	-	-	-	-
NJ2305-E-TVP2	1,1	1,1	-	34	50,2	38,1	1,9	0,35	HJ2305-E	4	8	0,03
NUP2305-E-TVP2	1,1	1,1	-	34	50,2	38,1	-	0,36	-	-	-	-
NJ206-E-TVP2	1	0,6	-	37,5	52,3	41,4	1,4	0,2	HJ206-E	4	7	0,02
NUP206-E-TVP2	1	0,6	-	37,5	52,3	41,4	-	0,21	-	-	-	-
NJ2206-E-TVP2	1	0,6	-	37,5	52,3	41,4	1,6	0,26	HJ2206-E	4	7,5	0,03
NUP2206-E-TVP2	1	0,6	-	37,5	52,3	41,4	-	0,27	-	-	-	-
NJ306-E-TVP2	1,1	1,1	-	40,5	58,7	45,1	0,6	0,37	HJ306-E	5	8,5	0,04
NUP306-E-TVP2	1,1	1,1	-	40,5	58,7	45,1	-	0,38	-	-	-	-
NJ2306-E-TVP2	1,1	1,1	-	40,5	58,7	45,1	2,2	0,54	HJ2306-E	5	9,5	0,04
NUP2306-E-TVP2	1,1	1,1	-	40,5	58,7	45,1	-	0,55	-	-	-	-

\*Dimensiones en mm. / \* Dimensions in mm.

\*\*Masa en kg. / \*\* Mass in kg.



## 2.1.2 Rodamientos de una hilera de rodillos cilíndricos con jaula Single row cylindrical roller bearings with cage

### RODAMIENTOS DE APOYO Y FIJOS / SEMI-LOCATING AND LOCATING BEARINGS

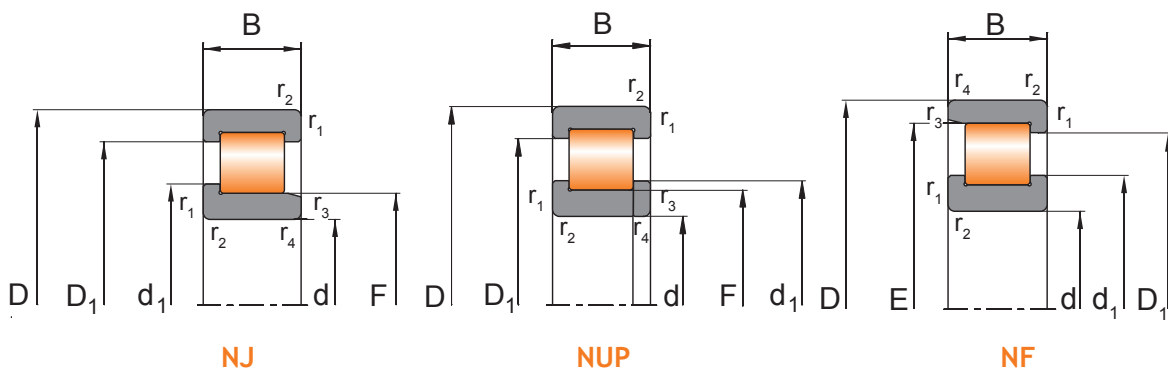

DIMENSIONES* BOUNDARY DIMENSIONS*			DESIGNACION DESIGNATION	E <sup>+</sup>	CAPACIDAD DE CARGA (kN) LOAD RATING (kN)			CARGA LÍMITE DE FATIGA / FATIGUE LIMIT LOAD (kN) Cu	VELOCIDADES LÍMITE SPEED RATINGS (rpm)	
d	D	B			dyn. Cr	dyn. E <sup>+</sup> Cr E <sup>+</sup>	stat. Cor		ng aceite ng oil	ng grasa ng grease
30	90	23	NJ406-M	-	75	-	60	10	13.500	10.900
35	72	17	NJ207-E-TVP2	E <sup>+</sup>	54,5	57,4	48,2	6,2	10.500	8.600
	72	17	NUP207-E-TVP2	E <sup>+</sup>	54,5	57,4	48,2	6,2	10.500	8.600
	72	23	NJ2207-E-TVP2	E <sup>+</sup>	67,7	70,6	63,4	9,5	10.500	8.600
	72	23	NUP2207-E-TVP2	E <sup>+</sup>	67,7	70,6	63,4	9,5	10.500	8.600
	80	21	NJ307-E-TVP2	E <sup>+</sup>	72,1	75,8	63	8,5	9.800	7.800
	80	21	NUP307-E-TVP2	E <sup>+</sup>	72,1	75,8	63	8,5	9.800	7.800
	80	21	NF307-E-TVP2	E <sup>+</sup>	72,1	75,8	63	8,5	9.000	7.800
	80	31	NJ2307-E-TVP2	E <sup>+</sup>	101	107	98	13,3	9.800	7.800
	80	31	NUP2307-E-TVP2	E <sup>+</sup>	101	107	98	13,3	9.800	7.800
	100	25	NJ407-M	-	86	-	80	10,8	11.500	9.500
40	80	18	NJ208-E-TVP2	E <sup>+</sup>	59,3	62,5	53	6,8	9.500	7.600
	80	18	NUP208-E-TVP2	E <sup>+</sup>	59,3	62,5	53	6,8	9.500	7.600
	80	18	NF208-E-TVP2	E <sup>+</sup>	59,3	62,5	53	6,8	9.500	7.600
	80	23	NJ2208-E-TVP2	E <sup>+</sup>	78,6	82	75	11	9.500	7.600
	80	23	NUP2208-E-TVP2	E <sup>+</sup>	78,6	82	75	11	9.500	7.600
	90	23	NJ308-E-TVP2	E <sup>+</sup>	88,5	93,7	78	10,3	8.200	6.500
	90	23	NUP308-E-TVP2	E <sup>+</sup>	88,5	93,7	78	10,3	8.200	6.500
	90	23	NF308-E-TVP2	E <sup>+</sup>	88,5	93,7	78	10,3	8.200	6.500
	90	33	NJ2308-E-TVP2	E <sup>+</sup>	122	129	119	18,3	8.200	6.500
	90	33	NUP2308-E-TVP2	E <sup>+</sup>	122	129	119	18,3	8.200	6.500
	110	27	NJ408-M	-	114	-	93,1	12,3	10.000	8.000
45	75	16	NJ1009-E-TVP2	-	41	-	36,5	5,1	15.000	12.400
	85	19	NJ209-E-TVP2	E <sup>+</sup>	66,9	70,9	63,1	8	9.000	7.100
	85	19	NUP209-E-TVP2	E <sup>+</sup>	66,9	70,9	63,1	8	9.000	7.100
	85	23	NJ2209-E-TVP2	E <sup>+</sup>	80,8	85,6	81,9	13,4	9.000	7.100
	85	23	NUP2209-E-TVP2	E <sup>+</sup>	80,8	85,6	81,9	13,4	9.000	7.100
	100	25	NJ309-E-TVP2	E <sup>+</sup>	110	115	98,2	13	7.800	6.200
	100	25	NUP309-E-TVP2	E <sup>+</sup>	110	115	98,2	13	7.800	6.200
	100	36	NJ2309-E-TVP2	E <sup>+</sup>	153	161	153	25	7.800	6.200
	100	36	NUP2309-E-TVP2	E <sup>+</sup>	153	161	153	25	7.800	6.200
	120	29	NJ409-M	-	136	-	115	15,5	9.000	7.400

\*Dimensiones en mm. / \* Dimensions in mm.

\*\*Masa en kg. / \*\* Mass in kg.

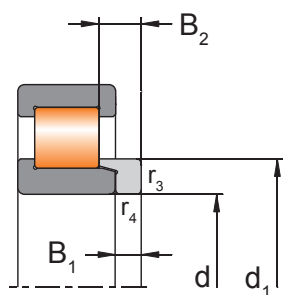

NJ + HJ

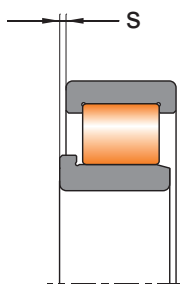

NJ

Axial Displacement (s)

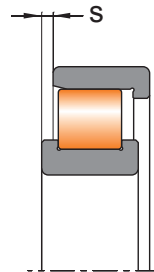

NF

Axial Displacement (s)

DESIGNACION DESIGNATION	r <sub>1</sub> , r <sub>2</sub> (min)	r <sub>3</sub> , r <sub>4</sub> (min)	DIMENSIONES SECUNDARIAS SECONDARY DIMENSIONS					MASA** MASS**	ANILLO ANGULAR THRUST COLLAR			
			E	F	D <sub>1</sub>	d <sub>1</sub>	s		Desig.	B <sub>1</sub>	B <sub>2</sub>	Masa** Mass**
NJ406-M	1,5	1,5	73	45	66,6	50,5	2,3	0,86	HJ406	7	11,5	0,08
NJ207-E-TVP2	1,1	0,6	-	44	60,9	48	0,7	0,3	HJ207-E	4	7	0,03
NUP207-E-TVP2	1,1	0,6	-	44	60,9	48	-	0,31	-	-	-	-
NJ2207-E-TVP2	1,1	0,6	-	44	60,9	48	2,2	0,41	HJ2207-E	4	8,5	0,04
NUP2207-E-TVP2	1,1	0,6	-	44	60,9	48	-	0,42	-	-	-	-
NJ307-E-TVP2	1,5	1,1	-	46,2	66,7	51	0,6	0,49	HJ307-E	6	9,5	0,06
NUP307-E-TVP2	1,5	1,1	-	46,2	66,7	51	-	0,5	-	-	-	-
NF307-E-TVP2	1,5	1,1	70,2	-	66,7	51	0,6	0,49	-	-	-	-
NJ2307-E-TVP2	1,5	1,1	-	46,2	66,7	51	3	0,73	HJ2307-E	6	11	0,06
NUP2307-E-TVP2	1,5	1,1	-	46,2	66,7	51	-	0,75	-	-	-	-
NJ407-M	1,5	1,5	-	53	78,2	58,8	2,6	1,15	HJ407	8	13	0,13
NJ208-E-TVP2	1,1	1,1	-	49,5	68,3	54	1	0,39	HJ208-E	5	8,5	0,05
NUP208-E-TVP2	1,1	1,1	-	49,5	68,3	54	-	0,4	-	-	-	-
NF208-E-TVP2	1,1	1,1	71,5	-	68,3	54	1	0,39	-	-	-	-
NJ2208-E-TVP2	1,1	1,1	-	49,5	67,5	54	1,5	0,5	HJ2208-E	5	9	0,05
NUP2208-E-TVP2	1,1	1,1	-	49,5	67,5	54	-	0,51	-	-	-	-
NJ308-E-TVP2	1,5	1,5	-	52	75,5	57,6	1,2	0,67	HJ308-E	7	11	0,09
NUP308-E-TVP2	1,5	1,5	-	52	75,5	57,6	-	0,68	-	-	-	-
NF308-E-TVP2	1,5	1,5	80	-	75,5	57,6	1,2	0,67	-	-	-	-
NJ2308-E-TVP2	1,5	1,5	-	52	75,5	57,6	2,7	0,96	HJ2308-E	7	12,5	0,09
NUP2308-E-TVP2	1,5	1,5	-	52	75,5	57,6	-	0,99	-	-	-	-
NJ408-M	2	2	-	58	86,4	64,6	2,8	1,49	HJ408	8	13	0,15
NJ1009-E-TVP2	1	0,6	-	52,5	64,5	56,3	2,5	0,27	-	-	-	-
NJ209-E-TVP2	1,1	1,1	-	54,5	73	59	1	0,44	HJ209-E	5	8,5	0,05
NUP209-E-TVP2	1,1	1,1	-	54,5	73	59	-	0,45	-	-	-	-
NJ2209-E-TVP2	1,1	1,1	-	54,5	72,5	59	1,5	0,54	HJ2209-E	5	9	0,06
NUP2209-E-TVP2	1,1	1,1	-	54,5	72,5	59	-	0,55	-	-	-	-
NJ309-E-TVP2	1,5	1,5	-	58,5	83,7	64,4	1	0,92	HJ309-E	7	11,5	0,11
NUP309-E-TVP2	1,5	1,5	-	58,5	83,7	64,4	-	0,94	-	-	-	-
NJ2309-E-TVP2	1,5	1,5	-	58,5	84,1	64,4	2,5	1,33	HJ2309-E	7	13	0,12
NUP2309-E-TVP2	1,5	1,5	-	58,5	84,1	64,4	-	1,36	-	-	-	-
NJ409-M	2	2	-	64,5	93,9	71,8	2,9	1,87	HJ409	8	13,5	0,18

\*Dimensiones en mm. / \* Dimensions in mm.

\*\*Masa en kg. / \*\* Mass in kg.



## 2.1.2 Rodamientos de una hilera de rodillos cilíndricos con jaula Single row cylindrical roller bearings with cage

### RODAMIENTOS DE APOYO Y FIJOS / SEMI-LOCATING AND LOCATING BEARINGS

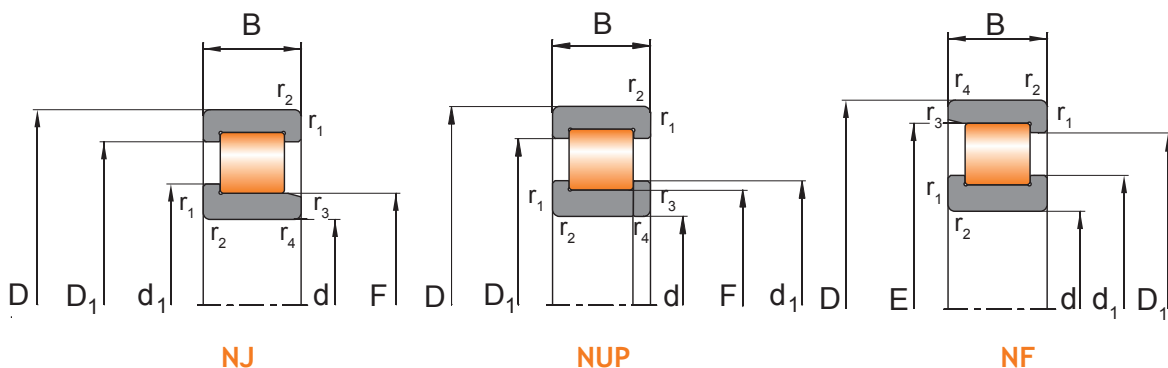

DIMENSIONES* BOUNDARY DIMENSIONS*			DESIGNACION DESIGNATION	E <sup>+</sup>	CAPACIDAD DE CARGA (kN) LOAD RATING (kN)			CARGA LÍMITE DE FATIGA / FATIGUE LIMIT LOAD (kN) Cu	VELOCIDADES LÍMITE SPEED RATINGS (rpm)	
d	D	B			dyn. Cr	dyn. E <sup>-</sup> Cr E <sup>-</sup>	stat. Cor		ng aceite ng oil	ng grasa ng grease
50	90	20	NJ210-E-TVP2	E <sup>+</sup>	70,7	74,7	69,4	9	8.500	6.800
	90	20	NUP210-E-TVP2	E <sup>+</sup>	70,7	74,7	69,4	9	8.500	6.800
	90	23	NJ2210-E-TVP2	E <sup>+</sup>	86,1	90	88	12,4	8.500	6.800
	90	23	NUP2210-E-TVP2	E <sup>+</sup>	86,1	90	88	12,4	8.500	6.800
	110	27	NJ310-E-TVP2	E <sup>+</sup>	123	130	112	15,5	7.000	5.600
	110	27	NUP310-E-TVP2	E <sup>+</sup>	123	130	112	15,5	7.000	5.600
	110	27	NF310-E-TVP2	E <sup>+</sup>	123	130	112	15,5	7.000	5.600
	110	40	NJ2310-E-TVP2	E <sup>+</sup>	180	190	186	30	7.000	5.600
	110	40	NUP2310-E-TVP2	E <sup>+</sup>	180	190	186	30	7.000	5.600
	130	31	NJ410-M	-	170	-	145	23	8.000	6.600
55	90	18	NJ1011-E-TVP2	-	60	-	60	7,5	13.000	10.500
	100	21	NJ211-E-TVP2	E <sup>+</sup>	93,2	98	95	13	7.500	6.000
	100	21	NUP211-E-TVP2	E <sup>+</sup>	93,2	98	95	13	7.500	6.000
	100	21	NF211-E-M1	E <sup>+</sup>	93,2	98	95	13	7.500	6.000
	100	25	NJ2211-E-TVP2	E <sup>+</sup>	110	115	118	17	7.500	6.000
	100	25	NUP2211-E-TVP2	E <sup>+</sup>	110	115	118	17	7.500	6.000
	120	29	NJ311-E-TVP2	E <sup>+</sup>	151	158	140	19,1	6.000	4.800
	120	29	NUP311-E-TVP2	E <sup>+</sup>	151	158	140	19,1	6.000	4.800
	120	43	NJ2311-E-TVP2	E <sup>+</sup>	225	234	230	40	6.000	4.800
	120	43	NUP2311-E-TVP2	E <sup>+</sup>	225	234	230	40	6.000	4.800
140	33	NJ411-M	-	180	-	160	22	7.400	6.100	
60	110	22	NJ212-E-TVP2	E <sup>+</sup>	105	110	102	13,7	7.000	5.500
	110	22	NUP212-E-TVP2	E <sup>+</sup>	105	110	102	13,7	7.000	5.500
	110	28	NJ2212-E-TVP2	E <sup>+</sup>	143	150	153	25,4	7.000	5.500
	110	28	NUP2212-E-TVP2	E <sup>+</sup>	143	150	153	25,4	7.000	5.500
	130	31	NJ312-E-TVP2	E <sup>+</sup>	168	176	159	21,4	5.400	4.400
	130	31	NUP312-E-TVP2	E <sup>+</sup>	168	176	159	21,4	5.400	4.400
	130	46	NJ2312-E-TVP2	E <sup>+</sup>	249	263	260	45,5	5.400	4.400
	130	46	NUP2312-E-TVP2	E <sup>+</sup>	249	263	260	45,5	5.400	4.400
150	35	NJ412-M	-	200	-	179	24,4	6.900	5.500	
65	120	23	NJ213-E-TVP2	E <sup>+</sup>	118	125	118	16	6.200	5.000
	120	23	NUP213-E-TVP2	E <sup>+</sup>	118	125	118	16	6.200	5.000

\*Dimensiones en mm. / \* Dimensions in mm.

\*\*Masa en kg. / \*\* Mass in kg.

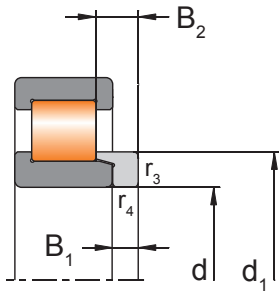

NJ + HJ

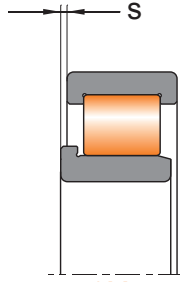

NJ

Axial Displacement (s)

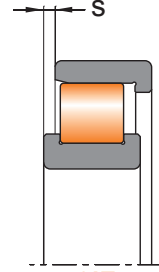

NF

Axial Displacement (s)

DESIGNACION DESIGNATION	r <sub>1</sub> , r <sub>2</sub> (min)	r <sub>3</sub> , r <sub>4</sub> (min)	DIMENSIONES SECUNDARIAS SECONDARY DIMENSIONS					MASA** MASS**	ANILLO ANGULAR THRUST COLLAR			
			E	F	D <sub>1</sub>	d <sub>1</sub>	s		Desig.	B <sub>1</sub>	B <sub>2</sub>	Masa** Mass**
NJ210-E-TVP2	1,1	1,1	-	59,5	78	64	1,3	0,5	HJ210-E	5	9	0,06
NUP210-E-TVP2	1,1	1,1	-	59,5	78	64	-	0,51	-	-	-	-
NJ2210-E-TVP2	1,1	1,1	-	59,5	77,7	64	1,3	0,58	HJ210-E	5	9	0,06
NUP2210-E-TVP2	1,1	1,1	-	59,5	77,7	64	-	0,59	-	-	-	-
NJ310-E-TVP2	2	2	-	65	92	71,3	1,7	1,18	HJ310-E	8	13	0,15
NUP310-E-TVP2	2	2	-	65	92	71,3	-	1,2	-	-	-	-
NF310-E-TVP2	2	2	97	-	92	71,3	1,7	1,18	-	-	-	-
NJ2310-E-TVP2	2	2	-	65	92	71,3	3,2	1,77	HJ2310-E	8	14,5	0,16
NUP2310-E-TVP2	2	2	-	65	92	71,3	-	1,8	-	-	-	-
NJ410-M	2,1	2,1	-	70,8	103,5	78,8	3	2,3	HJ410	9	14,5	0,24
NJ1011-E-TVP2	1,1	1	-	64	79,2	68,5	2,1	0,42	-	-	-	-
NJ211-E-TVP2	1,5	1,1	-	66	86,2	71	0,8	0,68	HJ211-E	6	9,5	0,09
NUP211-E-TVP2	1,5	1,1	-	66	86,2	71	-	0,69	-	-	-	-
NF211-E-M1	1,5	1,1	90	-	86,2	71	0,8	0,73	-	-	-	-
NJ2211-E-TVP2	1,5	1,1	-	66	86,2	71	1,3	0,81	HJ2211-E	6	10	0,09
NUP2211-E-TVP2	1,5	1,1	-	66	86,2	71	-	0,82	-	-	-	-
NJ311-E-TVP2	2	2	-	70,5	101	77,7	1,8	1,51	HJ311-E	9	14	0,19
NUP311-E-TVP2	2	2	-	70,5	101	77,7	-	1,54	-	-	-	-
NJ2311-E-TVP2	2	2	-	70,5	101	77,5	3,3	2,27	HJ2311-E	9	15,5	0,20
NUP2311-E-TVP2	2	2	-	70,5	101	77,5	-	2,3	-	-	-	-
NJ411-M	2,1	2,1	-	77,2	110	82,5	3,3	2,7	HJ411	10	16,5	0,3
NJ212-E-TVP2	1,5	1,5	-	72	95,7	77,7	1,6	0,83	HJ212-E	6	10	0,11
NUP212-E-TVP2	1,5	1,5	-	72	95,7	77,7	-	0,86	-	-	-	-
NJ2212-E-TVP2	1,5	1,5	-	72	95,7	77,7	1,6	1,1	HJ212-E	6	10	0,11
NUP2212-E-TVP2	1,5	1,5	-	72	95,7	77,7	-	1,14	-	-	-	-
NJ312-E-TVP2	2,1	2,1	-	77	109,5	84,5	1,9	1,87	HJ312-E	9	14,5	0,23
NUP312-E-TVP2	2,1	2,1	-	77	109,5	84,5	-	1,9	-	-	-	-
NJ2312-E-TVP2	2,1	2,1	-	77	109,6	84,4	3,5	2,8	HJ2312-E	9	16	0,24
NUP2312-E-TVP2	2,1	2,1	-	77	109,6	84,4	-	2,86	-	-	-	-
NJ412-M	2,1	2,1	-	83	117	91,8	3,4	3,2	HJ412	10	16,5	0,35
NJ213-E-TVP2	1,5	1,5	-	78,5	104,3	84,5	1,4	1,06	HJ213-E	6	10	0,13
NUP213-E-TVP2	1,5	1,5	-	78,5	104,3	84,5	-	1,1	-	-	-	-

\*Dimensiones en mm. / \* Dimensions in mm.

\*\*Masa en kg. / \*\* Mass in kg.



## 2.1.2 Rodamientos de una hilera de rodillos cilíndricos con jaula Single row cylindrical roller bearings with cage

### RODAMIENTOS DE APOYO Y FIJOS / SEMI-LOCATING AND LOCATING BEARINGS

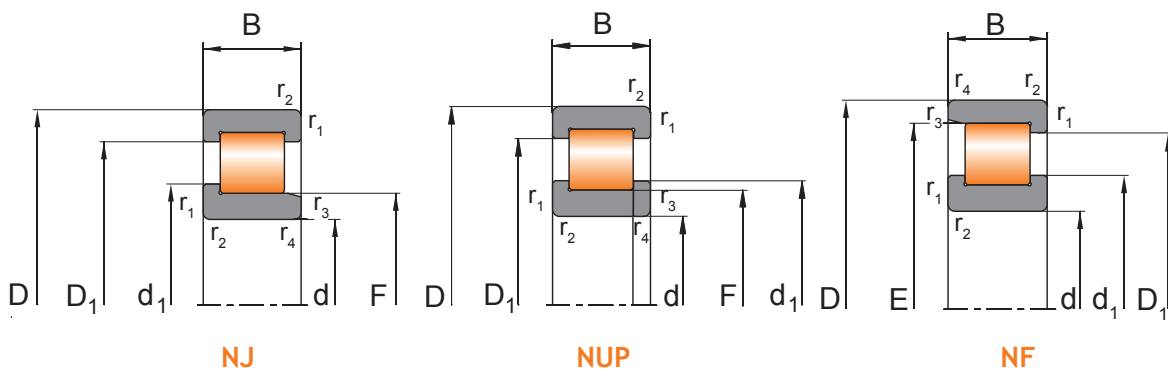

DIMENSIONES* BOUNDARY DIMENSIONS*			DESIGNACION DESIGNATION	E <sup>+</sup>	CAPACIDAD DE CARGA (kN) LOAD RATING (kN)			CARGA LÍMITE DE FATIGA / FATIGUE LIMIT LOAD (kN) Cu	VELOCIDADES LÍMITE SPEED RATINGS (rpm)	
d	D	B			dyn. Cr	dyn. E <sup>+</sup> Cr E <sup>+</sup>	stat. Cor		ng aceite ng oil	ng grasa ng grease
65	120	31	NJ2213-E-TVP2	E <sup>+</sup>	163	175	181	28,6	6.200	5.000
	120	31	NUP2213-E-TVP2	E <sup>+</sup>	163	175	181	28,6	6.200	5.000
	140	33	NJ313-E-TVP2	E <sup>+</sup>	200	212	195	26	5.000	4.000
	140	33	NUP313-E-TVP2	E <sup>+</sup>	200	212	195	26	5.000	4.000
	140	48	NJ2313-E-TVP2	E <sup>+</sup>	276	290	285	46	5.000	4.000
	140	48	NUP2313-E-TVP2	E <sup>+</sup>	276	290	285	46	5.000	4.000
160	37	NJ413-M	-	220	-	200	26	7.000	5.600	
70	125	24	NJ214-E-TVP2	E <sup>+</sup>	131	138	137	19	5.300	4.400
	125	24	NUP214-E-TVP2	E <sup>+</sup>	131	138	137	19	5.300	4.400
	125	31	NJ2214-E-TVP2	E <sup>+</sup>	172	182	193	30	5.300	4.400
	125	31	NUP2214-E-TVP2	E <sup>+</sup>	172	182	193	30	5.300	4.400
	150	35	NJ314-E-TVP2	E <sup>+</sup>	230	240	220	30	4.500	3.600
	150	35	NUP314-E-TVP2	E <sup>+</sup>	230	240	220	30	4.500	3.600
	150	51	NJ2314-E-TVP2	E <sup>+</sup>	306	320	325	55	4.500	3.600
	150	51	NUP2314-E-TVP2	E <sup>+</sup>	306	320	325	55	4.500	3.600
180	42	NJ414-M	-	270	-	250	33	6.400	5.100	
75	130	25	NJ215-E-TVP2	E <sup>+</sup>	145	152	156	21,5	5.300	4.200
	130	25	NUP215-E-TVP2	E <sup>+</sup>	145	152	156	21,5	5.300	4.200
	130	31	NJ2215-E-TVP2	E <sup>+</sup>	182	191	208	34,3	5.300	4.200
	130	31	NUP2215-E-TVP2	E <sup>+</sup>	182	191	208	34,3	5.300	4.200
	160	37	NJ315-E-TVP2	E <sup>+</sup>	268	282	265	34	4.000	3.200
	160	37	NUP315-E-TVP2	E <sup>+</sup>	268	282	265	34	4.000	3.200
	160	55	NJ2315-E-TVP2	E <sup>+</sup>	365	388	397	52	4.000	3.200
	160	55	NUP2315-E-TVP2	E <sup>+</sup>	365	388	397	52	4.000	3.200
190	45	NJ415-M	-	315	-	291	37	6.000	4.800	
80	125	22	NJ1016-M	-	83	-	96	11,4	9.100	7.400
	140	26	NJ216-E-TVP2	E <sup>+</sup>	154	161	166	22,3	5.000	4.100
	140	26	NUP216-E-TVP2	E <sup>+</sup>	154	161	166	22,3	5.000	4.100
	140	33	NJ2216-E-TVP2	E <sup>+</sup>	206	218	244	37	5.000	4.100
	140	33	NUP2216-E-TVP2	E <sup>+</sup>	206	218	244	37	5.000	4.100
	170	39	NJ316-E-TVP2	E <sup>+</sup>	286	300	280	37	3.900	3.200
170	39	NUP316-E-TVP2	E <sup>+</sup>	286	300	280	37	3.900	3.200	

\*Dimensiones en mm. / \* Dimensions in mm.

\*\*Masa en kg. / \*\* Mass in kg.

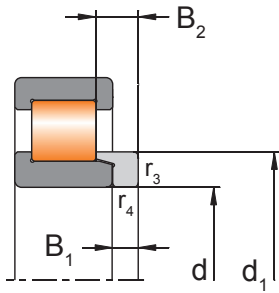

NJ + HJ

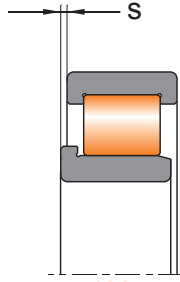

NJ

Axial Displacement (s)

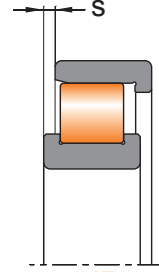

NF

Axial Displacement (s)

DESIGNACION DESIGNATION	r <sub>1</sub> , r <sub>2</sub> (min)	r <sub>3</sub> , r <sub>4</sub> (min)	DIMENSIONES SECUNDARIAS SECONDARY DIMENSIONS					MASA** MASS**	ANILLO ANGULAR THRUST COLLAR			
			E	F	D <sub>1</sub>	d <sub>1</sub>	s		Desig.	B <sub>1</sub>	B <sub>2</sub>	Masa** Mass**
NJ2213-E-TVP2	1,5	1,5	-	78,5	104,3	84,6	1,9	1,46	HJ2213-E	6	10,5	0,13
NUP2213-E-TVP2	1,5	1,5	-	78,5	104,3	84,6	-	1,52	-	-	-	-
NJ313-E-TVP2	2,1	2,1	-	82,5	118,5	90,7	1,4	2,3	HJ313-E	10	15,5	0,28
NUP313-E-TVP2	2,1	2,1	-	82,5	118,5	90,7	-	2,35	-	-	-	-
NJ2313-E-TVP2	2,1	2,1	-	82,5	118,6	90,5	4	3,4	HJ2313-E	10	18	0,3
NUP2313-E-TVP2	2,1	2,1	-	82,5	118,6	90,5	-	3,5	-	-	-	-
NJ413-M	2,1	2,1	-	89,3	125	98,5	3,5	4,1	HJ413	11	18	0,43
NJ214-E-TVP2	1,5	1,5	-	83,5	108,7	89,6	1,6	1,17	HJ214-E	7	11	0,15
NUP214-E-TVP2	1,5	1,5	-	83,5	108,7	89,6	-	1,2	-	-	-	-
NJ2214-E-TVP2	1,5	1,5	-	83,5	108,7	89,6	1,6	1,55	HJ2214-E	7	11,5	0,16
NUP2214-E-TVP2	1,5	1,5	-	83,5	108,7	89,6	-	1,55	-	-	-	-
NJ314-E-TVP2	2,1	2,1	-	89	126,4	97,5	1,6	2,8	HJ314-E	10	15,5	0,33
NUP314-E-TVP2	2,1	2,1	-	89	126,4	97,5	-	2,85	-	-	-	-
NJ2314-E-TVP2	2,1	2,1	-	89	126,4	97,5	4,7	4	HJ2314-E	10	18,5	0,35
NUP2314-E-TVP2	2,1	2,1	-	89	126,4	97,5	-	4,1	-	-	-	-
NJ414-M	3	3	-	100	141	110	4	5,9	HJ414	12	20	0,63
NJ215-E-TVP2	1,5	1,5	-	88,5	114	94,5	1,1	1,3	HJ215-E	7	11	0,16
NUP215-E-TVP2	1,5	1,5	-	88,5	114	94,5	-	1,35	-	-	-	-
NJ2215-E-TVP2	1,5	1,5	-	88,5	113,5	94,5	1,6	1,6	HJ2215-E	7	11,5	0,17
NUP2215-E-TVP2	1,5	1,5	-	88,5	113,5	94,5	-	1,65	-	-	-	-
NJ315-E-TVP2	2,1	2,1	-	95	136,2	104,1	1,1	3,4	HJ315-E	11	16,5	0,41
NUP315-E-TVP2	2,1	2,1	-	95	136,2	104,1	-	3,45	-	-	-	-
NJ2315-E-TVP2	2,1	2,1	-	95	136,2	104,1	4,2	5	HJ2315-E	11	19,5	0,44
NUP2315-E-TVP2	2,1	2,1	-	95	136,2	104,1	-	5,1	-	-	-	-
NJ415-M	3	3	-	104,5	150,7	115,8	4,5	7,2	HJ415	13	21,5	0,72
NJ1016-M	1,1	1	-	91,5	109,6	96,2	2,7	1,1	-	-	-	-
NJ216-E-TVP2	2	2	-	95,3	122,3	101,7	1,2	1,6	HJ216-E	8	12,5	0,22
NUP216-E-TVP2	2	2	-	95,3	122,3	101,7	-	1,65	-	-	-	-
NJ2216-E-TVP2	2	2	-	95,3	122,3	101,7	1,3	2,05	HJ216-E	8	12,5	0,22
NUP2216-E-TVP2	2	2	-	95,3	122,3	101,7	-	2,08	-	-	-	-
NJ316-E-TVP2	2,1	2,1	-	101	143,9	110,4	0,6	4,05	HJ316-E	11	17	0,46
NUP316-E-TVP2	2,1	2,1	-	101	143,9	110,4	-	4,1	-	-	-	-

\*Dimensiones en mm. / \* Dimensions in mm.

\*\*Masa en kg. / \*\* Mass in kg.



## 2.1.2 Rodamientos de una hilera de rodillos cilíndricos con jaula Single row cylindrical roller bearings with cage

### RODAMIENTOS DE APOYO Y FIJOS / SEMI-LOCATING AND LOCATING BEARINGS

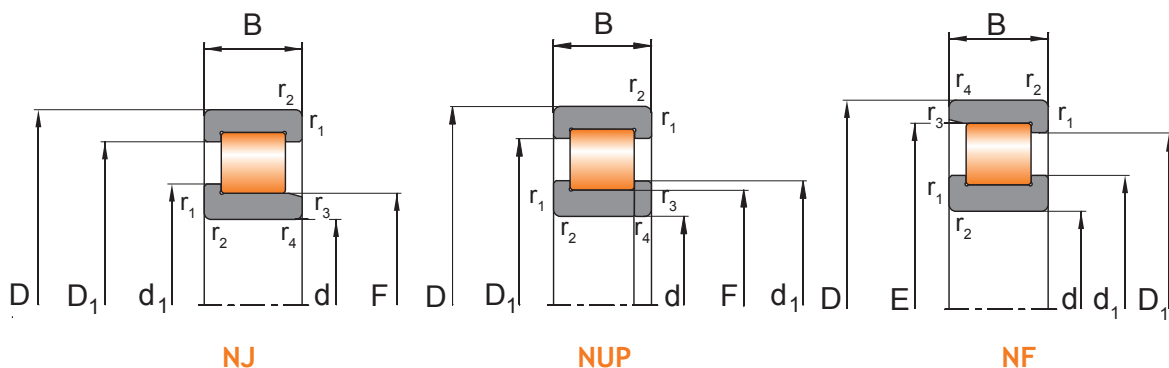

DIMENSIONES* BOUNDARY DIMENSIONS*			DESIGNACION DESIGNATION	E <sup>+</sup>	CAPACIDAD DE CARGA (kN) LOAD RATING (kN)			CARGA LÍMITE DE FATIGA / FATIGUE LIMIT LOAD (kN) Cu	VELOCIDADES LÍMITE SPEED RATINGS (rpm)	
d	D	B			dyn. Cr	dyn. E <sup>+</sup> Cr E <sup>+</sup>	stat. Cor		ng aceite ng oil	ng grasa ng grease
80	170	58	NJ2316-E-TVP2	E <sup>+</sup>	393	418	440	56,1	3.900	3.200
	170	58	NUP2316-E-TVP2	E <sup>+</sup>	393	418	440	56,1	3.900	3.200
	200	48	NJ416-M	-	380	-	355	55	5.500	4.400
85	130	22	NJ1017-M	-	90	-	99	13,5	9.000	7.400
	150	28	NJ217-E-TVP2	E <sup>+</sup>	181	191	198	25	4.800	3.800
	150	28	NUP217-E-TVP2	E <sup>+</sup>	181	191	198	25	4.800	3.800
	150	36	NJ2217-E-TVP2	E <sup>+</sup>	241	254	278	45,5	4.800	3.800
	150	36	NUP2217-E-TVP2	E <sup>+</sup>	241	254	278	45,5	4.800	3.800
	180	41	NJ317-E-M1	E <sup>+</sup>	323	340	328	41	3.800	3.000
	180	41	NUP317-E-M1	E <sup>+</sup>	323	340	328	41	3.800	3.000
	180	60	NJ2317-E-TVP2	E <sup>+</sup>	426	446	456	69,9	3.800	3.000
	180	60	NUP2317-E-TVP2	E <sup>+</sup>	426	446	456	69,9	3.800	3.000
	210	52	NJ417-M	-	410	-	370	57	5.000	4.000
90	160	30	NJ218-E-TVP2	E <sup>+</sup>	200	211	219	28	4.500	3.600
	160	30	NUP218-E-TVP2	E <sup>+</sup>	200	211	219	28	4.500	3.600
	160	40	NJ2218-E-TVP2	E <sup>+</sup>	267	283	315	50	4.500	3.600
	160	40	NUP2218-E-TVP2	E <sup>+</sup>	267	283	315	50	4.500	3.600
	190	43	NJ318-E-M1	E <sup>+</sup>	349	365	353	44	3.600	2.900
	190	43	NUP318-E-M1	E <sup>+</sup>	349	365	353	44	3.600	2.900
	190	64	NJ2318-E-TVP2	E <sup>+</sup>	480	500	530	72,6	3.600	2.900
	190	64	NUP2318-E-TVP2	E <sup>+</sup>	480	500	530	72,6	3.600	4.000
95	170	32	NJ219-E-TVP2	E <sup>+</sup>	245	255	265	33	4.200	3.400
	170	32	NUP219-E-TVP2	E <sup>+</sup>	245	255	265	33	4.200	3.400
	170	43	NJ2219-E-TVP2	E <sup>+</sup>	317	330	373	57,6	4.200	3.400
	170	43	NUP2219-E-TVP2	E <sup>+</sup>	317	330	373	57,6	4.200	3.400
	200	45	NJ319-E-M1	E <sup>+</sup>	373	390	386	47,5	3.600	2.900
	200	45	NUP319-E-M1	E <sup>+</sup>	373	390	386	47,5	3.600	2.900
	200	67	NJ2319-E-TVP2	E <sup>+</sup>	510	540	585	89	3.600	2.900
	200	67	NUP2319-E-TVP2	E <sup>+</sup>	510	540	585	89	3.600	2.900
100	180	34	NJ220-E-TVP2	E <sup>+</sup>	280	293	305	38	4.000	3.300
	180	34	NUP220-E-TVP2	E <sup>+</sup>	280	293	305	38	4.000	3.300
	180	46	NJ2220-E-TVP2	E <sup>+</sup>	367	384	446	65,2	4.000	3.300

\*Dimensiones en mm. / \* Dimensions in mm.

\*\*Masa en kg. / \*\* Mass in kg.



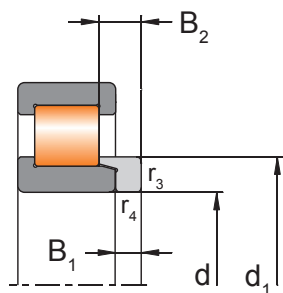

NJ + HJ

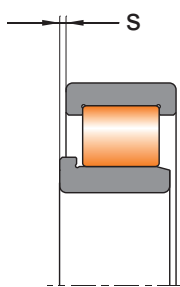

NJ

Axial Displacement (s)

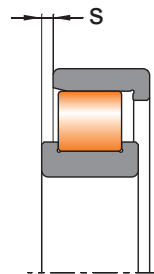

NF

Axial Displacement (s)

DESIGNACION DESIGNATION	r <sub>1</sub> , r <sub>2</sub> (min)	r <sub>3</sub> , r <sub>4</sub> (min)	DIMENSIONES SECUNDARIAS SECONDARY DIMENSIONS					MASA** MASS**	ANILLO ANGULAR THRUST COLLAR			
			E	F	D <sub>1</sub>	d <sub>1</sub>	s		Desig.	B <sub>1</sub>	B <sub>2</sub>	Masa** Mass**
NJ2316-E-TVP2	2,1	2,1	-	101	143,9	110,4	3,7	5,9	HJ2316-E	11	20	0,49
NUP2316-E-TVP2	2,1	2,1	-	101	143,9	110,4	-	6,1	-	-	-	-
NJ416-M	3	3	-	110	159,7	121,8	4,6	8,5	HJ416	13	22	0,78
NJ1017-M	1,1	1	-	96,5	114,8	100	4	1,05	-	-	-	-
NJ217-E-TVP2	2	2	-	100,5	131	107,6	0,7	1,95	HJ217-E	8	12,5	0,25
NUP217-E-TVP2	2	2	-	100,5	131	107,6	-	2	-	-	-	-
NJ2217-E-TVP2	2	2	-	100,5	131	107,6	1,3	2,55	HJ2217-E	8	13	0,25
NUP2217-E-TVP2	2	2	-	100,5	131	107,6	-	2,6	-	-	-	-
NJ317-E-M1	3	3	-	108	152,4	118	1,1	5,4	HJ317-E	12	18,5	0,57
NUP317-E-M1	3	3	-	108	152,4	118	-	5,5	-	-	-	-
NJ2317-E-TVP2	3	3	-	108	152,7	118	4,7	6,9	HJ2317-E	12	22	0,61
NUP2317-E-TVP2	3	3	-	108	152,7	118	-	7	-	-	-	-
NJ417-M	4	4	-	113	165,7	125,8	5,2	10	HJ417	14	24	0,90
NJ218-E-TVP2	2	2	-	107	139,5	114,5	1,4	2,4	HJ218-E	9	14	0,32
NUP218-E-TVP2	2	2	-	107	139,5	114,5	-	2,45	-	-	-	-
NJ2218-E-TVP2	2	2	-	107	139,5	114,3	2,5	3,25	HJ2218-E	9	15	0,32
NUP2218-E-TVP2	2	2	-	107	139,5	114,3	-	3,3	-	-	-	-
NJ318-E-M1	3	3	-	113,5	159,4	124	1,3	6,2	HJ318-E	12	18,5	0,62
NUP318-E-M1	3	3	-	113,5	159,4	124	-	6,3	-	-	-	-
NJ2318-E-TVP2	3	3	-	113,5	161,6	124	5	8,2	HJ2318-E	12	22	0,67
NUP2318-E-TVP2	3	3	-	113,5	161,6	124	-	8,3	-	-	-	-
NJ219-E-TVP2	2,1	2,1	-	112,5	148,6	120,5	0,6	2,95	HJ219-E	9	14	0,35
NUP219-E-TVP2	2,1	2,1	-	112,5	148,6	120,5	-	3	-	-	-	-
NJ2219-E-TVP2	2,1	2,1	-	112,5	148,5	120,5	2,2	4	HJ2219-E	9	15,5	0,37
NUP2219-E-TVP2	2,1	2,1	-	112,5	148,5	120,5	-	4,1	-	-	-	-
NJ319-E-M1	3	3	-	121,5	169,6	132	1,4	7	HJ319-E	13	20,5	0,78
NUP319-E-M1	3	3	-	121,5	169,6	132	-	7,1	-	-	-	-
NJ2319-E-TVP2	3	3	-	121,5	169,6	132	5,6	9,5	HJ2319-E	13	24,5	0,83
NUP2319-E-TVP2	3	3	-	121,5	169,6	132	-	9,75	-	-	-	-
NJ220-E-TVP2	2,1	2,1	-	119	154,2	130	1,4	3,55	HJ220-E	10	15	0,44
NUP220-E-TVP2	2,1	2,1	-	119	154,2	130	-	3,6	-	-	-	-
NJ2220-E-TVP2	2,1	2,1	-	119	154,8	127,3	2,5	4,85	HJ2220-E	10	16	0,45

\*Dimensiones en mm. / \* Dimensions in mm.

\*\*Masa en kg. / \*\* Mass in kg.



## 2.1.2 Rodamientos de una hilera de rodillos cilíndricos con jaula Single row cylindrical roller bearings with cage

### RODAMIENTOS DE APOYO Y FIJOS / SEMI-LOCATING AND LOCATING BEARINGS

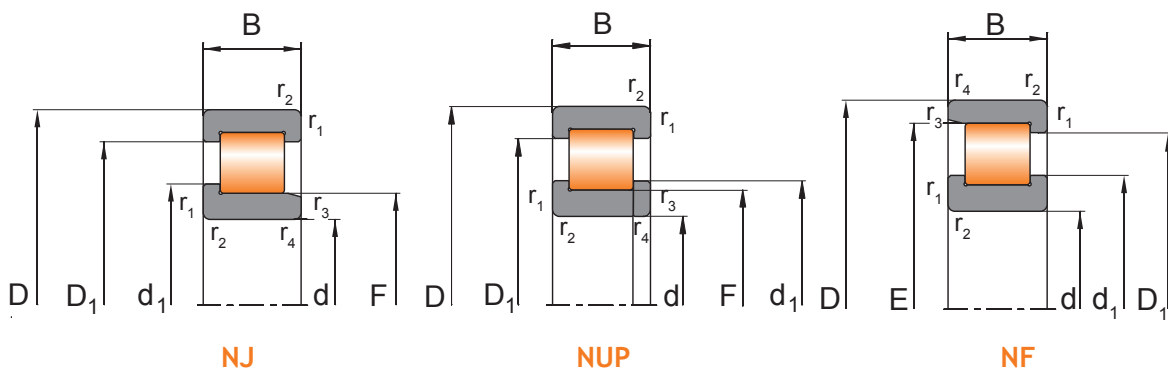

DIMENSIONES* BOUNDARY DIMENSIONS*			DESIGNACION DESIGNATION	E <sup>+</sup>	CAPACIDAD DE CARGA (kN) LOAD RATING (kN)			CARGA LÍMITE DE FATIGA / FATIGUE LIMIT LOAD (kN) Cu	VELOCIDADES LÍMITE SPEED RATINGS (rpm)	
d	D	B			dyn. Cr	dyn. E <sup>+</sup> Cr E <sup>+</sup>	stat. Cor		ng aceite ng oil	ng grasa ng grease
100	180	46	NUP2220-E-TVP2	E <sup>+</sup>	367	384	446	65,2	4.000	3.300
	215	47	NJ320-E-M1	E <sup>+</sup>	428	450	433	53	3.500	2.800
	215	47	NUP320-E-M1	E <sup>+</sup>	428	450	433	53	3.500	2.800
	215	47	NF320-E-M1	E <sup>+</sup>	428	450	433	53	3.500	2.800
	215	73	NJ2320-E-TVP2	E <sup>+</sup>	640	675	730	105	3.500	2.800
	215	73	NUP2320-E-TVP2	E <sup>+</sup>	640	675	730	105	3.500	2.800
105	190	36	NJ221-E-TVP2	E <sup>+</sup>	295	307	316	39,5	3.900	3.100
	190	36	NUP221-E-TVP2	E <sup>+</sup>	295	307	316	39,5	3.900	3.100
110	200	38	NJ222-E-TVP2	E <sup>+</sup>	319	338	365	50	3.600	2.900
	200	38	NUP222-E-TVP2	E <sup>+</sup>	319	338	365	50	3.600	2.900
	200	53	NJ2222-E-TVP2	E <sup>+</sup>	426	449	520	80,8	3.600	2.900
	200	53	NUP2222-E-TVP2	E <sup>+</sup>	426	449	520	80,8	3.600	2.900
	240	50	NJ322-E-M1	E <sup>+</sup>	500	530	515	60	3.300	2.600
	240	50	NUP322-E-M1	E <sup>+</sup>	500	530	515	60	3.300	2.600
	240	80	NJ2322-E-TVP2	E <sup>+</sup>	730	760	835	116	3.300	2.600
	240	80	NUP2322-E-TVP2	E <sup>+</sup>	730	760	835	116	3.300	2.600
	280	65	NJ422-M	-	640	-	645	92,7	4.000	3.300
	120	180	28	NJ1024-M	-	166	-	195	24,9	6.300
215		40	NJ224-E-TVP2	E <sup>+</sup>	373	390	420	51	3.400	2.700
215		40	NUP224-E-TVP2	E <sup>+</sup>	373	390	420	51	3.400	2.700
215		58	NJ2224-E-TVP2	E <sup>+</sup>	499	530	615	95	3.400	2.700
215		58	NUP2224-E-TVP2	E <sup>+</sup>	499	530	615	95	3.400	2.700
260		55	NJ324-E-M1	E <sup>+</sup>	585	610	610	70	3.000	2.400
260		55	NUP324-E-M1	E <sup>+</sup>	585	610	610	70	3.000	2.400
260		86	NJ2324-E-M1	E <sup>+</sup>	890	930	1.025	140	3.900	3.300
260		86	NUP2324-E-M1	E <sup>+</sup>	890	930	1.025	140	3.900	3.300
130		200	33	NJ1026-M	-	200	-	229	29,5	5.600
	230	40	NJ226-E-TVP2	E <sup>+</sup>	400	423	447	53,6	3.200	2.600
	230	40	NUP226-E-TVP2	E <sup>+</sup>	400	423	447	53,6	3.200	2.600
	230	64	NJ2226-E-TVP2	E <sup>+</sup>	590	620	735	100	3.200	2.600
	230	64	NUP2226-E-TVP2	E <sup>+</sup>	590	620	735	100	3.200	2.600
	280	58	NJ326-E-M1	E <sup>+</sup>	680	710	690	79,3	2.800	2.200

\*Dimensiones en mm. / \* Dimensions in mm.

\*\*Masa en kg. / \*\* Mass in kg.

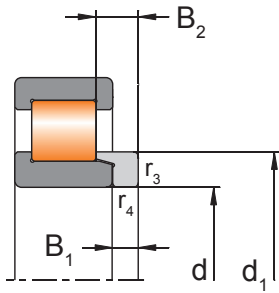

NJ + HJ

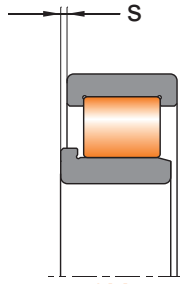

NJ

Axial Displacement (s)

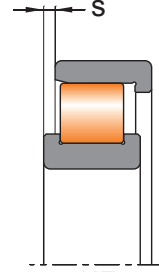

NF

Axial Displacement (s)

DESIGNACION DESIGNATION	r <sub>1</sub> , r <sub>2</sub> (min)	r <sub>3</sub> , r <sub>4</sub> (min)	DIMENSIONES SECUNDARIAS SECONDARY DIMENSIONS					MASA** MASS**	ANILLO ANGULAR THRUST COLLAR			
			E	F	D <sub>1</sub>	d <sub>1</sub>	s		Desig.	B <sub>1</sub>	B <sub>2</sub>	Masa** Mass**
NUP2220-E-TVP2	2,1	2,1	-	119	154,8	127,3	-	4,9	-	-	-	-
NJ320-E-M1	3	3	-	127,5	182	139,4	1,2	8,8	HJ320-E	13	20,5	0,88
NUP320-E-M1	3	3	-	127,5	182	139,4	-	9	-	-	-	-
NF320-E-M1	3	3	191,5	-	182	139,4	1,2	8,8	-	-	-	-
NJ2320-E-TVP2	3	3	-	127,5	178,7	139,4	4,2	12,3	HJ2320-E	13	23,5	0,93
NUP2320-E-TVP2	3	3	-	127,5	178,7	139,4	-	12,5	-	-	-	-
NJ221-E-TVP2	2,1	2,1	-	125,5	163,7	134,2	1,2	4,15	HJ221-E	10	16	0,51
NUP221-E-TVP2	2,1	2,1	-	125,5	163,7	134,2	-	4,3	-	-	-	-
NJ222-E-TVP2	2,1	2,1	-	132,5	174,6	141,6	1,4	4,9	HJ222-E	11	17	0,62
NUP222-E-TVP2	2,1	2,1	-	132,5	174,6	141,6	-	5	-	-	-	-
NJ2222-E-TVP2	2,1	2,1	-	132,5	174,6	141,6	4	6,9	HJ2222-E	11	19,5	0,65
NUP2222-E-TVP2	2,1	2,1	-	132,5	174,6	141,6	-	7	-	-	-	-
NJ322-E-M1	3	3	-	143	201,7	155,6	1,3	11,7	HJ322-E	14	22	1,21
NUP322-E-M1	3	3	-	143	201,7	155,6	-	11,9	-	-	-	-
NJ2322-E-TVP2	3	3	-	143	200,9	155,6	5,8	16,9	HJ2322-E	14	26,5	1,30
NUP2322-E-TVP2	3	3	-	143	200,9	155,6	-	17,2	-	-	-	-
NJ422-M	4	4	-	155	217	171	6,2	22,8	HJ422	17	29,5	2,10
NJ1024-M	2	1,1	-	135	159	120	3,2	2,6	-	-	-	-
NJ224-E-TVP2	2,1	2,1	-	143,5	188	153	1,4	5,9	HJ224-E	11	17	0,71
NUP224-E-TVP2	2,1	2,1	-	143,5	188	153	-	6	-	-	-	-
NJ2224-E-TVP2	2,1	2,1	-	143,5	187,8	153,2	4,5	8,5	HJ2224-E	11	20	0,75
NUP2224-E-TVP2	2,1	2,1	-	143,5	187,8	153,2	-	8,7	-	-	-	-
NJ324-E-M1	3	3	-	154	218,7	168,2	3,5	15,2	HJ324-E	14	22,5	1,41
NUP324-E-M1	3	3	-	154	218,7	168,2	-	15,5	-	-	-	-
NJ2324-E-M1	3	3	-	154	218,7	168,2	7,2	23,5	HJ2324-E	14	26	1,45
NUP2324-E-M1	3	3	-	154	218,7	168,2	-	23,8	-	-	-	-
NJ1026-M	2	1,1	-	148	175	154,5	3,9	3,9	-	-	-	-
NJ226-E-TVP2	3	3	-	153,5	201,2	164	1,2	6,6	HJ226-E	11	17	0,78
NUP226-E-TVP2	3	3	-	153,5	201,2	164	-	6,75	-	-	-	-
NJ2226-E-TVP2	3	3	-	153,5	201,2	164	5,2	10,6	HJ2226-E	11	21	0,85
NUP2226-E-TVP2	3	3	-	153,5	201,2	164	-	11	-	-	-	-
NJ326-E-M1	4	4	-	167	235,2	181,7	3,5	18,4	HJ326-E	14	23	1,64

\*Dimensiones en mm. / \* Dimensions in mm.

\*\*Masa en kg. / \*\* Mass in kg.



## 2.1.2 Rodamientos de una hilera de rodillos cilíndricos con jaula Single row cylindrical roller bearings with cage

### RODAMIENTOS DE APOYO Y FIJOS / SEMI-LOCATING AND LOCATING BEARINGS

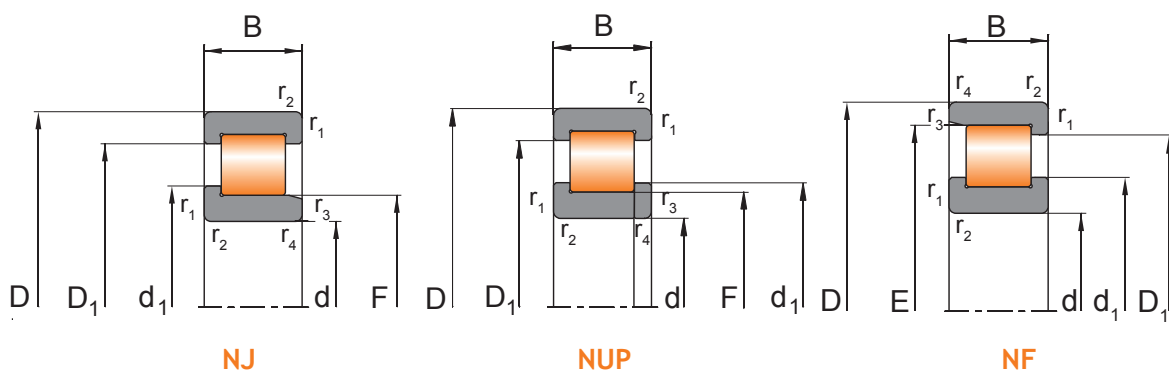

DIMENSIONES* BOUNDARY DIMENSIONS*			DESIGNACION DESIGNATION	E <sup>+</sup>	CAPACIDAD DE CARGA (kN) LOAD RATING (kN)			CARGA LÍMITE DE FATIGA / FATIGUE LIMIT LOAD (kN) Cu	VELOCIDADES LÍMITE SPEED RATINGS (rpm)	
d	D	B			dyn. Cr	dyn. E <sup>+</sup> Cr E <sup>+</sup>	stat. Cor		ng aceite ng oil	ng grasa ng grease
130	280	58	NUP326-E-M1	E <sup>+</sup>	680	710	690	79,3	2.800	2.200
	280	93	NJ2326-E-M1	E <sup>+</sup>	1.020	1070	1.240	160	3.700	3.000
	280	93	NUP2326-E-M1	E <sup>+</sup>	1.020	1.070	1.240	160	3.700	3.000
140	250	42	NJ228-E-M1	E <sup>+</sup>	435	460	510	58,6	4.500	3.600
	250	42	NUP228-E-M1	E <sup>+</sup>	435	460	510	58,6	4.500	3.600
	250	68	NJ2228-E-M1	E <sup>+</sup>	630	670	830	118	4.500	3.600
	250	68	NUP2228-E-M1	E <sup>+</sup>	630	670	830	118	4.500	3.600
	300	62	NJ328-E-TVP2	E <sup>+</sup>	755	790	815	90,4	2.600	2.100
	300	62	NUP328-E-TVP2	E <sup>+</sup>	755	790	815	90,4	2.600	2.100
150	225	35	NJ1030-M	-	238	-	290	35	5.000	4.100
	270	45	NJ230-E-M1	E <sup>+</sup>	490	515	595	67	4.200	3.300
	270	45	NUP230-E-M1	E <sup>+</sup>	490	515	595	67	4.200	3.300
	270	73	NJ2230-E-M1	E <sup>+</sup>	715	750	950	130	4.200	3.300
160	240	38	NJ1032-M	-	276	-	340	41	4.800	4.000
	290	48	NJ232-E-M1	E <sup>+</sup>	560	585	670	74	4.000	3.200
	290	48	NUP232-E-M1	E <sup>+</sup>	560	585	670	74	4.000	3.200
	290	80	NJ2232-E-M1	E <sup>+</sup>	890	935	1.180	142	3.600	3.000
	290	80	NUP2232-E-M1	E <sup>+</sup>	890	935	1.180	142	3.600	3.000
	340	68	NJ332-E-M1	E <sup>+</sup>	900	950	1.060	110	2.800	2.200
170	260	42	NJ1034-M	-	335	-	425	48,5	4.400	3.600
	310	52	NJ234-E-M1	E <sup>+</sup>	660	700	785	85,5	3.400	2.800
	310	52	NUP234-E-M1	E <sup>+</sup>	660	700	785	85,5	3.400	2.800
	310	86	NJ2234-E-M1	E <sup>+</sup>	1.010	1.070	1.370	170	3.200	2.600
	310	86	NUP2234-E-M1	E <sup>+</sup>	1.010	1.070	1.370	170	3.200	2.600

\*Dimensiones en mm. / \* Dimensions in mm.

\*\*Masa en kg. / \*\* Mass in kg.

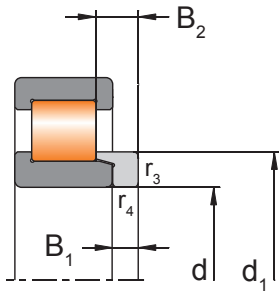

NJ + HJ

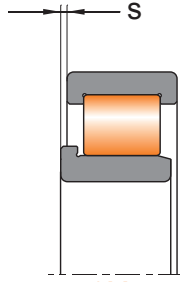

NJ

Axial Displacement (s)

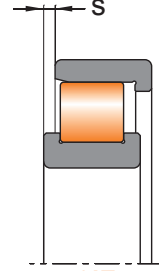

NF

Axial Displacement (s)

DESIGNACION DESIGNATION	r <sub>1</sub> , r <sub>2</sub> (min)	r <sub>3</sub> , r <sub>4</sub> (min)	DIMENSIONES SECUNDARIAS SECONDARY DIMENSIONS					MASA** MASS**	ANILLO ANGULAR THRUST COLLAR			
			E	F	D <sub>1</sub>	d <sub>1</sub>	s		Desig.	B <sub>1</sub>	B <sub>2</sub>	Masa** Mass**
NUP326-E-M1	4	4	-	167	235,2	181,7	-	18,8	-	-	-	-
NJ2326-E-M1	4	4	-	167	235,2	181,7	8,1	29,4	HJ2326-E	14	28	1,77
NUP2326-E-M1	4	4	-	167	235,2	181,7	-	29,9	-	-	-	-
NJ228-E-M1	3	3	-	169	216,7	179,4	2	9,5	HJ228-E	11	18	0,99
NUP228-E-M1	3	3	-	169	216,7	179,4	-	9,6	-	-	-	-
NJ2228-E-M1	3	3	-	169	216,7	179,4	7	15,3	HJ2228-E	11	23	1,08
NUP2228-E-M1	3	3	-	169	216,7	179,4	-	15,6	-	-	-	-
NJ328-E-TVP2	4	4	-	180	251,7	195,4	5,2	20,5	HJ328-E	15	25	2
NUP328-E-TVP2	4	4	-	180	251,7	195,4	-	21	-	-	-	-
NJ2328-E-M1	4	4	-	180	251,7	195,4	9,2	37,3	HJ2328-E	15	31	2,20
NUP2328-E-M1	4	4	-	180	251,7	195,4	-	37,8	-	-	-	-
NJ1030-M	2,1	1,5	-	169,5	199	176	4,2	5	-	-	-	-
NJ230-E-M1	3	3	-	182	233,2	193,7	4	12	HJ230-E	12	19,5	1,26
NUP230-E-M1	3	3	-	182	233,2	193,7	-	12,2	-	-	-	-
NJ2230-E-M1	3	3	-	182	233,2	193,1	7,5	19	HJ2230-E	12	24,5	1,36
NUP2230-E-M1	3	3	-	182	233,2	193,1	-	19,4	-	-	-	-
NJ330-E-M1	4	4	-	193	269,8	209,5	5,5	27,1	HJ330-E	15	25	2,33
NUP330-E-M1	4	4	-	193	269,8	209,5	-	27,6	-	-	-	-
NJ2330-E-M1	4	4	-	193	268,4	210	9,7	45,2	HJ2330-E	15	31,5	2,55
NUP2330-E-M1	4	4	-	193	268,4	210	-	45,7	-	-	-	-
NJ1032-M	2,1	1,5	-	180	212,9	189	4,3	6,1	HJ1032	10	19	0,7
NJ232-E-M1	3	3	-	195	249,6	206,8	4,1	14,8	HJ232-E	12	20	1,47
NUP232-E-M1	3	3	-	195	249,6	206,8	-	15,1	-	-	-	-
NJ2232-E-M1	3	3	-	193	251,1	205,5	7,2	24,3	HJ2232-E	12	24,5	1,56
NUP2232-E-M1	3	3	-	193	251,1	205,5	-	24,8	-	-	-	-
NJ332-E-M1	4	4	-	204	286	221,6	5,5	32,4	HJ332-E	15	25	2,58
NJ2332-E-M1	4	4	-	204	286	221,6	9,9	53	HJ2332-E	15	32	2,85
NJ1034-M	2,1	2,1	-	193	229,1	202	4,8	8,2	HJ1034	11	21	0,94
NJ234-E-M1	4	4	-	207	268,5	218,4	4,3	18,4	HJ234-E	12	20	1,58
NUP234-E-M1	4	4	-	207	268,5	218,4	-	18,8	-	-	-	-
NJ2234-E-M1	4	4	-	205	269,9	219	7,2	29,8	HJ2234-E	12	24	1,78
NUP2234-E-M1	4	4	-	205	269,9	219	-	30,2	-	-	-	-

\*Dimensiones en mm. / \* Dimensions in mm.

\*\*Masa en kg. / \*\* Mass in kg.



## 2.1.2 Rodamientos de una hilera de rodillos cilíndricos con jaula Single row cylindrical roller bearings with cage

### RODAMIENTOS DE APOYO Y FIJOS / SEMI-LOCATING AND LOCATING BEARINGS

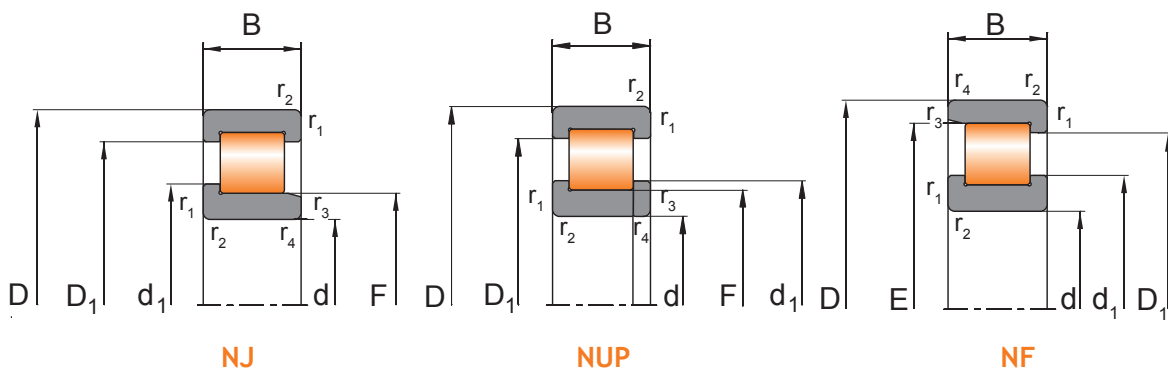

DIMENSIONES* BOUNDARY DIMENSIONS*			DESIGNACION DESIGNATION	E <sup>+</sup>	CAPACIDAD DE CARGA (kN) LOAD RATING (kN)			CARGA LÍMITE DE FATIGA / FATIGUE LIMIT LOAD (kN) Cu	VELOCIDADES LÍMITE SPEED RATINGS (rpm)	
d	D	B			dyn. Cr	dyn. E <sup>+</sup> Cr E <sup>+</sup>	stat. Cor		ng aceite ng oil	ng grasa ng grease
170	360	72	NJ334-E-M1	E <sup>+</sup>	910	960	1.190	113	2.600	2.100
	360	120	NJ2334-E-M1	E <sup>+</sup>	1.420	1.490	2.060	226	2.800	2.300
180	280	46	NJ1036-M	-	402	-	486	58,6	4.200	3.400
	320	52	NJ236-E-M1	E <sup>+</sup>	685	720	835	90	3.200	2.500
	320	52	NUP236-E-M1	E <sup>+</sup>	685	720	835	90	3.200	2.500
	320	86	NJ2236-E-M1	E <sup>+</sup>	1.100	1.150	1.440	195	3.200	2.500
	320	86	NUP2236-E-M1	E <sup>+</sup>	1.100	1.150	1.440	195	3.200	2.500
	380	75	NJ336-E-M1	E <sup>+</sup>	975	1.040	1.310	117	2.600	2.100
	380	126	NJ2336-E-M1	E <sup>+</sup>	1.580	1.660	2.280	250	2.800	2.300
	440	95	NUP436-M	-	1.200	-	1.550	140	2.400	1.900
190	260	33	NJ1938-E-M1	E <sup>+</sup>	230	248	390	41	3.900	3.200
	290	46	NJ1038-M	-	420	-	540	60	3.900	3.200
	340	55	NJ238-E-M1	E <sup>+</sup>	705	735	935	86,8	3.000	2.400
	340	55	NUP238-E-M1	E <sup>+</sup>	705	735	935	86,8	3.000	2.400
	340	92	NJ2238-E-M1	E <sup>+</sup>	1.050	1.100	1.620	180	3.000	2.400
	400	132	NJ2338-E-M1	E <sup>+</sup>	1.800	1.880	2.600	269	2.600	2.100
200	280	38	NJ1940-E-M1	E <sup>+</sup>	315	338	520	53	3.700	2.900
	360	58	NJ240-E-M1	E <sup>+</sup>	730	760	1.030	94,8	2.900	2.300
	360	58	NUP240-E-M1	E <sup>+</sup>	730	760	1.030	94,8	2.900	2.300
	360	98	NJ2240-E-M1	E <sup>+</sup>	1.180	1.250	1.830	190	2.900	2.300
	420	80	NJ340-E-M1	E <sup>+</sup>	1.150	1.200	1.580	132	2.400	2.000
	420	138	NJ2340-E-M1	E <sup>+</sup>	1.910	2.010	2.800	300	2.400	2.000
220	300	38	NJ1944-E-M1	E <sup>+</sup>	310	334	540	55	3.000	2.400
	340	56	NJ1044-M	-	505	-	750	71	3.000	2.400
	400	65	NJ244-E-M1	E <sup>+</sup>	955	1.000	1.300	113	2.600	2.100
	400	65	NUP244-E-M1	E <sup>+</sup>	955	1.000	1.300	113	2.600	2.100
	400	108	NUP2244-E-M1	E <sup>+</sup>	1.550	1.620	2.300	224	2.600	2.100
240	440	72	NJ248-E-M1	E <sup>+</sup>	1.070	1.120	1.490	131	2.400	1.900
	440	72	NUP248-E-M1	E <sup>+</sup>	1.070	1.120	1.490	131	2.400	1.900
	500	95	NJ348-E-M1	E <sup>+</sup>	1.650	1.730	2.300	175	2.000	1.600
260	400	65	NJ1052-M	-	630	-	975	98	2.600	2.100
	480	80	NJ252-E-M1	E <sup>+</sup>	1.210	1.280	1.790	155	2.200	1.800

\*Dimensiones en mm. / \* Dimensions in mm.

\*\*Masa en kg. / \*\* Mass in kg.

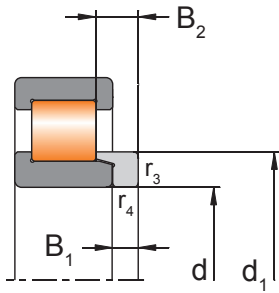

NJ + HJ

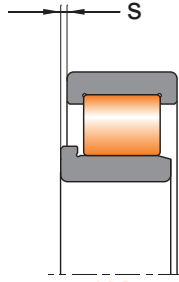

NJ

Axial Displacement (s)

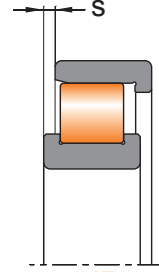

NF

Axial Displacement (s)

DESIGNACION DESIGNATION	r <sub>1</sub> , r <sub>2</sub> (min)	r <sub>3</sub> , r <sub>4</sub> (min)	DIMENSIONES SECUNDARIAS SECONDARY DIMENSIONS					MASA** MASS**	ANILLO ANGULAR THRUST COLLAR			
			E	F	D <sub>1</sub>	d <sub>1</sub>	s		Desig.	B <sub>1</sub>	B <sub>2</sub>	Masa** Mass**
NJ334-E-M1	4	4	-	218	301,6	237	5,9	38,5	HJ334-E	16	27	3,21
NJ2334-E-M1	4	4	-	216	269,9	219	10,2	62,8	HJ2334-E	16	33,5	3,53
NJ1036-M	2,1	2,1	-	205	245,9	216	5	10,5	HJ1036	12	22,5	1,25
NJ236-E-M1	4	4	-	217	278,6	230,2	4,7	19,3	HJ236-E	12	20	1,76
NUP236-E-M1	4	4	-	217	278,6	230,2	-	19,7	-	-	-	-
NJ2236-E-M1	4	4	-	215	280	229	7,2	31,3	HJ2236-E	12	24	1,87
NUP2236-E-M1	4	4	-	215	280	229	-	31,6	-	-	-	-
NJ336-E-M1	4	4	-	231	319,8	250,6	6,1	44,6	HJ336-E	17	28,5	3,77
NJ2336-E-M1	4	4	-	227	280	229	10,5	72,7	HJ2336-E	17	35	4,05
NUP436-M	6	6	-	-	343	275	-	80	-	-	-	-
NJ1938-E-M1	2	2	-	2.075	239	214	1	5,6	-	-	-	-
NJ1038-M	2,1	2,1	-	215	255,9	226	5	11	HJ1038	12	22,5	1,35
NJ238-E-M1	4	4	-	230	295	244	4,7	23,4	HJ238-E	13	21,5	2,17
NUP238-E-M1	4	4	-	230	295	244	-	23,8	-	-	-	-
NJ2238-E-M1	4	4	-	228	296,4	242,7	8	39	HJ2238-E	13	26,5	2,31
NJ2338-E-M1	5	5	-	240	296,4	242,6	11	84,1	HJ2338-E	18	36,5	4,8
NJ1940-E-M1	2,1	2,1	-	218	253,6	226	2,3	7,4	-	-	-	-
NJ240-E-M1	4	4	-	243	311,5	257,6	4,8	28,5	HJ240-E	14	23	2,62
NUP240-E-M1	4	4	-	243	311,5	257,6	-	29	-	-	-	-
NJ2240-E-M1	4	4	-	241	312,9	256,3	8,2	46	HJ2240-E	14	28	2,78
NJ340-E-M1	5	5	-	258	351,8	279	6,3	58	HJ340-E	18	30	4,94
NJ2340-E-M1	5	5	-	253	356,9	276,1	11,3	97,2	HJ2340-E	18	37	5,28
NJ1944-E-M1	2,1	2,1	-	240	275	248	1,1	8,2	-	-	-	-
NJ1044-M	3	3	-	250	298,9	261,7	6,2	20,6	HJ1044	14	27	2,1
NJ244-E-M1	4	4	-	268	344,9	285,2	5,5	39	HJ244-E	15	25	3,55
NUP244-E-M1	4	4	-	268	344,9	285,2	-	39,5	-	-	-	-
NUP2244-E-M1	4	4	-	259	349,4	279,4	-	63,5	-	-	-	-
NJ248-E-M1	4	4	-	293	376,6	312	6	52,5	HJ248-E	16	27	4,6
NUP248-E-M1	4	4	-	293	376,6	312	-	53,5	-	-	-	-
NJ348-E-M1	5	5	-	306	421,2	331,3	7,4	98	HJ348-E	22	35,5	8,3
NJ1052-M	4	4	-	296	351,3	309,1	7,2	30	HJ1052	16	31,5	3,3
NJ252-E-M1	5	5	-	317	410,8	336,9	6,2	70	HJ252-E	18	30	5,92

\*Dimensiones en mm. / \* Dimensions in mm.

\*\*Masa en kg. / \*\* Mass in kg.



## 2.1.2 Rodamientos de una hilera de rodillos cilíndricos con jaula Single row cylindrical roller bearings with cage

### RODAMIENTOS DE APOYO Y FIJOS / SEMI-LOCATING AND LOCATING BEARINGS

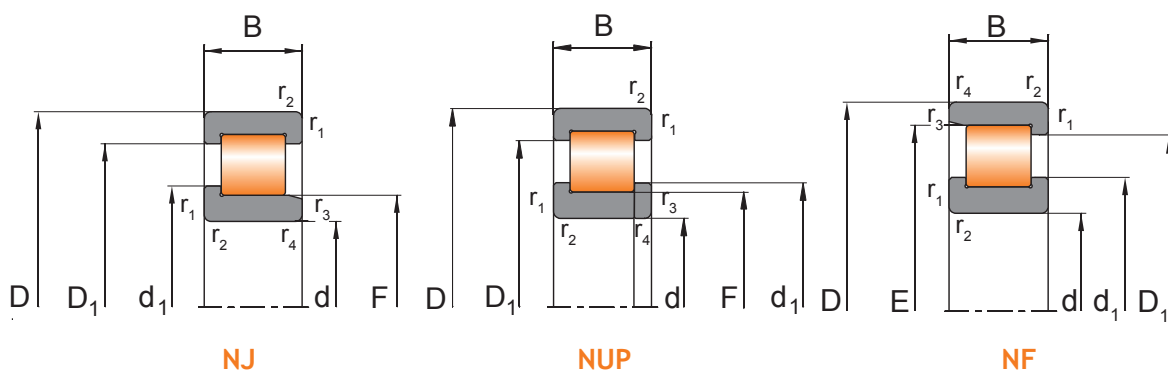

DIMENSIONES* BOUNDARY DIMENSIONS*			DESIGNACION DESIGNATION	E <sup>+</sup>	CAPACIDAD DE CARGA (kN) LOAD RATING (kN)			CARGA LÍMITE DE FATIGA / FATIGUE LIMIT LOAD (kN) Cu	VELOCIDADES LÍMITE SPEED RATINGS (rpm)	
d	D	B			dyn. Cr	dyn. E <sup>+</sup> Cr E <sup>+</sup>	stat. Cor		ng aceite ng oil	ng grasa ng grease
260	480	80	NUP252-E-M1	E <sup>+</sup>	1.210	1.280	1.790	155	2.200	1.800
280	580	108	NJ356-E-M1	E <sup>+</sup>	1.980	2.100	3.000	220	1.700	1.400
300	460	74	NJ1060-M	-	880	-	1.410	130	2.200	1.800
320	400	38	NUP1864-E-M1	E <sup>+</sup>	340	370	685	60	2.700	2.000
	480	74	NJ1064-M	-	905	-	1.450	128	2.100	1.700
340	520	82	NJ1068-M	-	1.080	-	1.750	158	1.900	1.500
380	480	46	NUP1876-M1	-	490	-	960	88	2.200	1.700
	560	82	NJ1076-M	-	1.160	-	1.970	170	1.800	1.400
420	520	46	NJ1884-M1	-	500	-	1.100	90	2.000	1.600
	560	65	NJ1984-E-M1	E <sup>+</sup>	835	900	1.600	150	1.900	1.500
	620	150	NF3084-E-M1	E <sup>+</sup>	2.800	3.000	5.400	420	1.500	1.200
440	600	118	NUP3988-E-M1	E <sup>+</sup>	1.850	1.970	4.300	370	1.200	1.100
480	600	56	NJ1896-M	-	690	-	1.500	120	1.800	1.500
	650	78	NJ1996-M	-	1.150	-	2.200	185	1.600	1.300
500	620	56	NF18/500-E-M	E <sup>+</sup>	695	745	1.550	130	1.500	1.100
530	710	82	NJ19/530-E-M	E <sup>+</sup>	1.280	1.350	2.600	220	1.400	1.100
560	680	56	NJ18/560-E-M	E <sup>+</sup>	710	740	1.700	130	1.500	1.100
	820	115	NJ10/560-M1	-	2.700	-	5.000	430	1.100	900
600	800	90	NUP19/600-E-M	E <sup>+</sup>	1.700	1.850	3.500	270	1.000	800
	800	90	NF19/600-M	-	1.700	-	3.500	270	1.000	800
630	780	69	NJ18/630-E-M	E <sup>+</sup>	1.140	1.200	2.550	200	1.100	800
	780	112	NF38/630-E-M	E <sup>+</sup>	2.000	2.180	5.200	450	800	600
	920	128	NUP10/630-M	-	3.100	-	6.000	470	1.000	800
670	820	69	NJ18/670-M	-	1.100	-	2.800	220	1.100	800
	900	103	NUP19/670-E-M	E <sup>+</sup>	2.000	2.200	4.500	300	900	700
750	920	78	NJ18/750-M	-	1.400	-	3.400	250	900	700
	1.000	112	NF19/750-E-M	E <sup>+</sup>	2.500	2.700	5.400	415	1.000	800
850	1.120	118	NF19/850-E-M	E <sup>+</sup>	3.000	3.200	6.500	490	800	600
1.000	1.220	128	NF28/1000-E-M	E <sup>+</sup>	3.360	3.600	10.000	700	600	500
1.120	1.360	106	NJ18/1120-E-M	E <sup>+</sup>	3.100	3.300	8.000	500	500	400
1.180	1.420	106	NJ18/1180-E-M	E <sup>+</sup>	2.850	3.000	7.800	520	400	300
	1.540	206	NUP29/1180-E-M	E <sup>+</sup>	8.350	8.900	21.600	1.300	300	200
1.320	1.600	122	NJ18/1320-E-M	E <sup>+</sup>	3.500	3.800	10.000	600	350	200

\*Dimensiones en mm. / \* Dimensions in mm. \*\*Masa en kg. / \*\* Mass in kg.



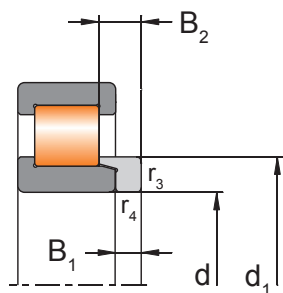

NJ + HJ

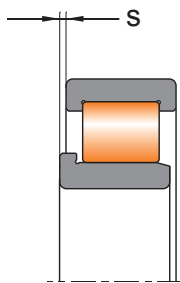

NJ

Axial Displacement (s)

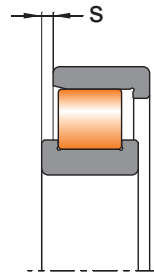

NF

Axial Displacement (s)

DESIGNACION DESIGNATION	r <sub>1</sub> , r <sub>2</sub> (min)	r <sub>3</sub> , r <sub>4</sub> (min)	DIMENSIONES SECUNDARIAS SECONDARY DIMENSIONS					MASA** MASS**	ANILLO ANGULAR THRUST COLLAR			
			E	F	D <sub>1</sub>	d <sub>1</sub>	s		Desig.	B <sub>1</sub>	B <sub>2</sub>	Masa** Mass**
NUP252-E-M1	5	5	-	317	410,8	336,9	-	71,5	-	-	-	-
NJ356-E-M1	6	6	-	362	488	389,8	8,7	149	HJ356-E	26	42,5	13,7
NJ1060-M	4	4	-	340	405,2	356	7,9	46,8	HJ1060	19	36	5,3
NUP1864-E-M1	2,1	1,5	-	341	373,8	347,7	-	11,5	-	-	-	-
NJ1064-M	4	4	-	360	425,1	375,4	8	48	HJ1064	19	36	5,6
NJ1068-M	5	5	-	385	458,2	402,2	8,9	67	HJ1068	21	39,5	7,4
NUP1876-M1	2,1	2,1	-	407,5	447,4	415,5	-	21	-	-	-	-
NJ1076-M	5	5	-	425	498,1	441,6	9	70	HJ1076	21	39,5	8,2
NJ1884-M1	2,1	2,1	-	448	488	456	5,3	21,5	-	-	-	-
NJ1984-E-M1	4	4	-	456	510,4	467,3	7,2	46	-	-	-	-
NF3084-E-M1	3	5	578	-	492	556	13,0	162	-	-	-	-
NUP3988-E-M1	4	4	-	-	552	495	-	105	-	-	-	-
NJ1896-M	3	3	-	514	560,5	523,5	6,6	36,5	-	-	-	-
NJ1996-M	5	5	-	525	589	540	6,8	78	-	-	-	-
NF18/500-E-M	3	3	590	-	580	543,5	6,6	38	-	-	-	-
NJ19/530-E-M	5	5	-	578	645,2	592	9,3	92	-	-	-	-
NJ18/560-E-M	3	3	-	594	640	603,5	6,6	42	-	-	-	-
NJ10/560-M1	6	6	-	626	731	650	9,8	215	HJ10/560	27,5	53	21
NUP19/600-E-M	5	5	-	652	730,7	667,5	-	130	-	-	-	-
NF19/600-M	5	5	748	-	730,7	667,5	9,9	128	-	-	-	-
NJ18/630-E-M	4	4	-	672	732	684	8,4	74	-	-	-	-
NF38/630-E-M	4	4	744	-	729	683	11,2	125	-	-	-	-
NUP10/630-M	7,5	7,5	-	700	826,2	728	-	300	-	-	-	-
NJ18/670-M	4	4	-	712	772	724	7,8	78	HJ18/670	20,5	37	11
NUP19/670-E-M	6	6	-	731	817	748,5	-	195	-	-	-	-
NJ18/750-M	5	5	-	799	866	812,5	8,8	112	-	-	-	-
NF19/750-E-M	6	6	935	-	911	834,5	12,1	265	-	-	-	-
NF19/850-E-M	6	6	1.049	-	1.024	941	12,6	325	-	-	-	-
NF28/1000-E-M	6	6	1.170	-	1.150	1.076	11	330	-	-	-	-
NJ18/1120-E-M	6	6	-	1.185	1.286	1.204	11	335	-	-	-	-
NJ18/1180-E-M	6	6	-	1.245	1.346	1.264	11	340	-	-	-	-
NUP29/1180-E-M	7,5	7,5	-	1.270	1.421	1.296	-	1.090	-	-	-	-
NJ18/1320-E-M	6	6	-	1.397	1.511	1.419	12,8	519	-	-	-	-

\*Dimensiones en mm. / \* Dimensions in mm. \*\*Masa en kg. / \*\* Mass in kg.



# 2.2

de doble hilera de rodillos cilíndricos  
cylindrical roller bearings  
Non-LOCATING BEARINGS



**BEARINGS EUROPE NBI**

DIMENSIONES BOUNDARY DIMENSIONS		DESIGNACION DESIGNATION	C	CAPACIDAD DE CARGA LOAD RATING (kN)	CAPACIDAD DE CARGA LIMIT LOAD (kN)	DESIGNACION DESIGNATION	TEMPERATURA MÁXIMA PERMITIDA MAXIMUM PERMITTED TEMPERATURE (°C)	TEMPERATURA MÍNIMA PERMITIDA MINIMUM PERMITTED TEMPERATURE (°C)	TEMPERATURA OPERACIONAL OPERATING TEMPERATURE	MASA MASES
30	55	19	NIN009..M-W33-PS1	25,3	25,1	NIN009..M-W33-PS1	100	100	100	0,14
35	62	20	NIN009..K-M-W33-PS1	25,3	25,1	NIN009..K-M-W33-PS1	100	100	100	0,14
40	68	21	NIN009..M-W33-PS1	42,7	44,7	NIN009..M-W33-PS1	100	100	100	0,25
45	75	23	NIN009..K-M-W33-PS1	40,8	52,5	NIN009..K-M-W33-PS1	100	100	100	0,35
50	80	23	NIN009..M-W33-PS1	49,8	52,5	NIN009..M-W33-PS1	100	100	100	0,45
55	90	25	NIN009..K-M-W33-PS1	57,1	54,9	NIN009..K-M-W33-PS1	100	100	100	0,65
60	95	25	NIN009..M-W33-PS1	69,8	71,9	NIN009..M-W33-PS1	100	100	100	0,85
65	100	25	NIN009..K-M-W33-PS1	69,8	71,9	NIN009..K-M-W33-PS1	100	100	100	0,85
70	110	30	NIN009..M-W33-PS1	70,7	74,3	NIN009..M-W33-PS1	100	100	100	1,15
75	115	30	NIN009..K-M-W33-PS1	72,7	75,5	NIN009..K-M-W33-PS1	100	100	100	1,15
80	125	34	NIN009..M-W33-PS1	95	97	NIN009..M-W33-PS1	100	100	100	1,65
85	130	34	NIN009..K-M-W33-PS1	95	97	NIN009..K-M-W33-PS1	100	100	100	1,65
90	140	37	NIN009..M-W33-PS1	114	120	NIN009..M-W33-PS1	100	100	100	2,05
95	145	37	NIN009..K-M-W33-PS1	114	120	NIN009..K-M-W33-PS1	100	100	100	2,05
100	140	40	NIN009..M-W33-PS1	139	139	NIN009..M-W33-PS1	100	100	100	2,45
100	140	40	NIN009..K-M-W33-PS1	139	139	NIN009..K-M-W33-PS1	100	100	100	2,45
150	150	37	NIN009..M-W33-PS1	159	146	NIN009..M-W33-PS1	100	100	100	2,45
150	150	37	NIN009..K-M-W33-PS1	159	146	NIN009..K-M-W33-PS1	100	100	100	2,45

• de rodillos cilíndricos • CYLINDRICAL ROLLER BEARINGS



Rodamientos de doble hilera de rodillos cilíndricos  
*Double row cylindrical roller bearings*

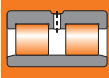

## 2.2 Rodamientos de doble hilera de rodillos cilíndricos *Double row cylindrical roller bearings*

índice

Características técnicas .....	62
Variantes de diseño estandarizadas .....	62
Desalineación .....	63
Tolerancias .....	63
Jaulas .....	66
Juego radial interno .....	66
Temperatura de funcionamiento .....	66
Carga mínima .....	66
Carga dinámica equivalente.....	66
Carga estática equivalente .....	67
Montaje.....	67
Dimensiones de los chaflanes .....	67
Designaciones complementarias .....	72
Tabla de dimensiones .....	74

index

Technical characteristics .....	62
Standard design variants .....	62
Misalignment .....	63
Tolerances .....	63
Cages .....	66
Internal radial clearance .....	66
Operating temperature .....	66
Minimum load .....	66
Equivalent dynamic bearing load .....	66
Equivalent static bearing load .....	67
Mounting .....	67
Abutment and fillet dimensions.....	67
Supplementary designations .....	72
Dimensions table.....	74

### NBI E<sup>+</sup> - SERIES CON SUPERIORES CAPACIDADES DE CARGA



NBI ha combinado los últimos avances en investigación de materiales y en metalurgia con su experiencia en diseño y fabricación de rodamientos para crear una nueva línea de rodamientos de rodillos cilíndricos con excepcionales prestaciones.

La mejora en la rugosidad de las pistas de rodadura y la optimización de los perfiles de las mismas, junto con el empleo de rodillos de un grado de precisión superior minimizan el rozamiento y optimizan la distribución de la carga. La circulación del lubricante también se favorece con un nuevo diseño de los flancos de guiado de los rodillos en las pistas.

La capacidad de aceptar desalineamientos y la capacidad de carga axial han aumentado como consecuencia de estas mejoras. Para todas las cuestiones acerca de las series NBI E<sup>+</sup>, consulte con nuestro departamento de ingeniería.

### NBI E<sup>+</sup> - SERIES WITH ENHANCED LOAD RATING CHARACTERISTICS

NBI has combined the latest achievements of metallurgy and material research with its expertise in bearing design and manufacturing to create a new line of cylindrical roller bearings with additional benefits.

Improvements in internal design features optimize the internal load distribution. Lubricant flow is enhanced by newly defined geometry of the bearings functional surfaces.

The ability to accept misalignments plus the axial load carrying capacity have increased due to these improvements. This technical progress allows for working with higher dynamic load ratings. For all questions you may have regarding the NBI E<sup>+</sup> series, please feel free to contact our engineering team.

NN30..-M-W33



NN30..-K-M-W33



NNU49..-M-W33



NNU49..-K-M-W33



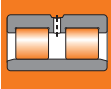

## RODAMIENTOS DE DOBLE HILERA DE RODILLOS CILÍNDRICOS

### Características técnicas

Las series NN30 y NNU49 de rodamientos de rodillos cilíndricos de doble hilera son rodamientos radiales desmontables.

Sus dimensiones principales se encuentran estandarizadas por la DIN 5412/part 4.

Son usados como rodamientos libres, sin fijación axial, en disposiciones de montaje de husillos de máquina herramienta. Por lo tanto, estos rodamientos son utilizados con clases de tolerancia de alta precisión, frecuentemente en combinación de juego interno reducido.

Estos rodamientos tienen como característica una capacidad de carga radial elevada y son satisfactorios en aplicaciones de altas velocidades, proporcionando una disposición de montaje rígida. Son usados comúnmente con agujero interior cónico, con el sufijo K (ej. Agujero interior cónico 1:12).

### Variantes de diseño estandarizadas

Los rodamientos de rodillos cilíndricos de doble hilera de las series NN30 y NNU49 son producidos y se encuentran disponibles con agujero interior cilíndrico o cónico.

Los rodamientos de la serie NN30 se componen por un aro exterior plano y un aro interior con tres hombros que hacen de guía de las dos hileras de rodillos.

Estas series de rodamientos son producidas con ranuras circunferenciales de engrase y agujeros de engrase, sufijo W33 como estándar.

Los rodamientos de rodillos cilíndricos de doble

## DOUBLE ROW CYLINDRICAL ROLLER BEARINGS

### Technical characteristics

Series NN30 and NNU49 double row cylindrical roller bearings are separable radial bearings.

Their main dimensions are standardized by DIN 5412/part 4.

They are used as non-locating bearings in bearing arrangements of machine tool spindles. Therefore, these bearings are normally used in high precision tolerance class, frequently in combination with reduced internal clearance.

These bearings also feature high radial load capacity and are satisfactory for high speed applications, providing a very stiff and rigid bearing arrangement. They are also commonly used with tapered bores, namely suffix K ( i.e. taper 1:12).

### Standard design variants

Double row cylindrical roller bearings of series NN30 and NNU49 are produced and available either with cylindrical or with tapered bores.

Bearings of series NN30 comprise of a plain outer ring and an inner ring with three integral ribs to guide the two roller rows.

These bearings series are standard produced with a circumferential lubrication groove and lubrication holes, suffix W33.

Bearings of series NNU49 comprise of a plain inner ring and an outer ring with three integral ribs to guide the two roller rows.

hileras de las series NNU49 presentan como característica de diseño interno un aro exterior con 3 labios integrados y un aro interior plano.

Estas series de rodamientos tienen como característica, además, una ranura de engrase y agujeros de lubricación en el aro exterior como estándar, sufijo W33.

Los rodamientos de rodillos cilíndricos de las series NN30 y NNU49 permiten la compensación de los cambios de longitud dentro de los rodamientos entre sí. En este sentido, son ideales para disposiciones de montaje sin fijación axial.

These bearing series also feature a lubrication groove and lubrication holes in the outer ring as standard, suffix W33.

Cylindrical roller bearings of series NN30 and NNU49 allow for compensation of length changes within the bearings itself. In this way they are ideal non-locating bearings.

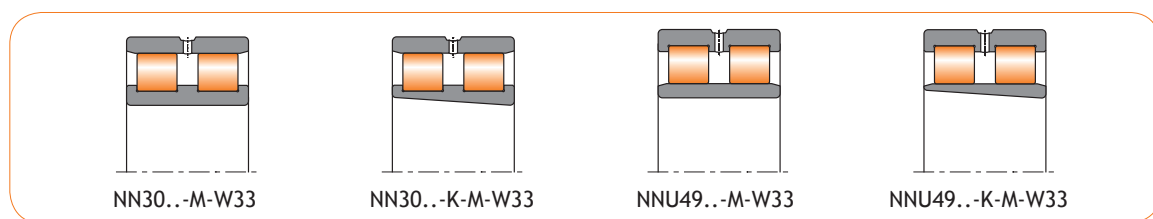

Fig. 1

### Desalineación

Los rodamientos de rodillos cilíndricos de doble hilera no admiten desalineación.

### Tolerancias

Los rodamientos de rodillos cilíndricos de doble hilera de las series NN30 y NNU49 son frecuentemente usados como rodamientos para husillos.

Por lo que, de forma estándar se suministran con clase de tolerancias más ajustadas, normalmente P5. Bajo pedido, se pueden suministrar con cualquier otro tipo de tolerancias.

Las tolerancias de estos rodamientos están de acuerdo con las normas ISO 492 y DIN 620/2. Éstas se muestran en las tablas correspondientes que aparecen en el capítulo de la Introducción.

### Misalignment

Double row cylindrical roller bearings are not able to accommodate misalignments.

### Tolerances

Double row cylindrical roller bearings of series NN30 and NNU49 are frequently used as spindle bearings.

Therefore, they are manufactured with tighter tolerances, usually P5. They can also be supplied on request, with any other types of tolerances.

The tolerances for these bearings are according to ISO 492 and DIN 620/2 and are shown in the tables displayed in the Introduction chapter.

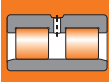

## 2.2 Rodamientos de doble hilera de rodillos cilíndricos Double row cylindrical roller bearings

Juego radial interno en  $\mu\text{m}$  de los rodamientos de doble hilera de rodillos cilíndricos NBI con eje cilíndrico

*Internal clearance in  $\mu\text{m}$  of NBI double row cylindrical roller bearings with cylindrical bore*

Juego radial Clearance group	Diámetro de eje / Bore diameter (mm)														
	>	-	24	30	40	50	65	80	100	120	140	160	180	200	225
	≤	24	30	40	50	65	80	100	120	140	160	180	200	225	250
C1	min	5	5	5	5	5	10	10	10	10	10	10	15	15	15
	max	15	15	15	18	20	25	30	30	35	35	40	45	50	50
C2	min	0	0	5	5	10	10	15	15	15	20	25	35	45	45
	max	25	25	30	35	40	45	50	55	60	70	75	90	105	110
CN	min	20	20	25	30	40	40	50	50	60	70	75	90	105	110
	max	45	45	50	60	70	75	85	90	105	120	125	145	165	175
C3	min	35	35	45	50	60	65	75	85	100	115	120	140	160	170
	max	60	60	70	80	90	100	110	125	145	165	170	195	220	235
C4	min	50	50	60	70	80	90	105	125	145	165	170	195	220	235
	max	75	75	85	100	110	125	140	165	190	215	220	250	280	300
C5	min	75	75	85	100	110	125	140	165	190	215	220	250	280	300
	max	100	100	110	130	140	160	175	205	235	265	270	305	340	365

Juego radial Clearance group	Diámetro de eje / Bore diameter (mm)														
	>	250	280	315	355	400	450	500	560	630	710	800	900	1.000	1.120
	≤	280	315	355	400	450	500	560	630	710	800	900	1.000	1.120	1.250
C1	min	20	20	20	25	25	25	25	30	30	35	35	35	50	230
	max	55	60	65	75	85	95	100	110	130	140	160	180	200	470
C2	min	55	55	65	100	110	110	120	140	145	150	180	200	220	230
	max	125	130	145	190	210	220	240	260	285	310	350	390	430	470
CN	min	125	130	145	190	210	220	240	260	285	310	350	390	430	470
	max	195	205	225	280	310	330	360	380	425	470	520	580	640	710
C3	min	190	200	225	280	310	330	360	380	425	470	520	580	640	710
	max	260	275	305	370	410	440	480	500	565	630	690	770	850	950
C4	min	260	275	305	370	410	440	480	500	565	630	690	770	850	950
	max	330	350	385	460	510	550	600	620	705	790	860	960	1.060	1.190
C5	min	330	350	385	460	510	550	600	620	705	790	860	960	1.060	1.510
	max	400	425	465	550	610	660	720	740	845	950	1.030	1.150	1.270	1.750

Tabla 1. Table 1



Juego radial interno en  $\mu\text{m}$  de los rodamientos de doble hilera de rodillos cilíndricos NBI  
con eje cónico

*Internal clearance in  $\mu\text{m}$  of NBI double row cylindrical roller bearings  
with tapered bore*

Juego radial Clearance group	Diámetro de eje / Bore diameter (mm)														
	>	-	24	30	40	50	65	80	100	120	140	160	180	200	225
	≤	24	30	40	50	65	80	100	120	140	160	180	200	225	250
C1	min	10	15	15	17	20	25	35	40	45	50	55	60	60	65
	max	20	25	25	30	35	40	55	60	70	75	85	90	95	100
C2	min	15	20	20	25	30	35	40	50	55	60	75	85	95	105
	max	40	45	45	55	60	70	75	90	100	110	125	140	155	170
CN	min	30	35	40	45	50	60	70	90	100	110	125	140	155	170
	max	55	60	65	75	80	95	105	130	145	160	175	195	215	235
C3	min	40	45	55	60	70	85	95	115	130	145	160	180	200	220
	max	65	70	80	90	100	120	130	155	175	195	210	235	260	285
C4	min	50	55	70	75	90	110	120	140	160	180	195	220	245	270
	max	75	80	95	105	120	145	155	180	205	230	245	275	305	335
C5	min	75	80	95	105	120	145	155	180	205	230	245	275	305	335
	max	100	105	120	135	150	180	190	220	250	280	295	330	365	400

Juego radial Clearance group	Diámetro de eje / Bore diameter (mm)														
	>	250	280	315	355	400	450	500	560	630	710	800	900	1.000	1.120
	≤	280	315	355	400	450	500	560	630	710	800	900	1.000	1.120	1.250
C1	min	75	80	90	100	110	120	130	140	160	170	190	210	230	-
	max	110	120	135	150	170	190	210	230	260	290	330	360	400	-
C2	min	115	130	145	165	185	205	230	260	295	325	370	410	455	490
	max	185	205	225	255	285	315	350	380	435	485	540	600	665	730
CN	min	185	205	225	255	285	315	350	380	435	485	540	600	665	730
	max	255	280	305	345	385	425	470	500	575	645	710	790	875	970
C3	min	240	265	290	330	370	410	455	500	565	630	700	780	865	960
	max	310	340	370	420	470	520	575	620	705	790	870	970	1075	1.200
C4	min	295	325	355	405	455	505	560	620	695	775	860	960	1065	1.200
	max	365	400	435	495	555	615	680	740	835	935	1.030	1.150	1.275	1.440
C5	min	365	400	435	495	555	615	680	740	835	935	1.030	1.150	1.275	-
	max	435	475	515	585	655	725	800	860	975	1.095	1.200	1.340	1.485	-

Tabla 2. Table 2

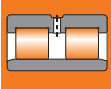

## Jaulas

Los rodamientos de rodillos cilíndricos de doble hilera de las series NN30 y NNU49 son producidos de forma estándar con jaulas de latón guiadas en los rodillos.

## Juego radial interno

Los rodamientos NBI de rodillos cilíndricos de doble hilera de precisión se fabrican, de forma estándar, con un juego radial interno C1.

Estos rodamientos también se pueden fabricar, bajo pedido, en otros grupos de tolerancia.

Los valores de los juegos aparecen en las tablas 1 y 2 (págs. 64 y 65) y están estandarizados en las normas DIN 620/parte 4 e ISO 5753.

### Nota:

Dado que estos rodamientos se fabrican con tolerancias muy estrictas, sus componentes separables no son intercambiables y no deben mezclarse.

## Temperatura de funcionamiento

Los rodamientos de rodillos cilíndricos con jaula, se pueden utilizar para temperaturas de funcionamiento desde  $-30^{\circ}\text{C}$  hasta  $+150^{\circ}\text{C}$ . En caso de que la temperatura en servicio supere los  $120^{\circ}\text{C}$  de forma continua, rogamos consulten con el departamento de ingeniería de aplicaciones de NBI.

## Carga mínima

Los rodamientos de rodillos cilíndricos requieren una carga mínima de más de un 4% sobre la capacidad de carga dinámica  $C_r$ , para evitar fricciones debidas al deslizamiento.

## Carga dinámica equivalente

Los rodamientos de rodillos cilíndricos de doble hilera de las series NN30 y NNU49 no son roda-

## Cages

Double row cylindrical roller bearings of the series NN30 and NNU49 are standard produced with roller riding solid brass cages.

## Internal radial clearance

NBI double row cylindrical roller bearings are, as standard, produced with group C1 internal clearance.

Other internal radial clearances are produced upon customer order.

The clearance values are shown in tables 1 and 2 (pages 64 and 65) and are standardized in DIN 620/part 4 and ISO 5753.

### Note:

As these bearings are produced to very closed tolerances, their components must not be mixed or exchanged with other bearing parts.

## Operating temperature

Single row cylindrical roller bearings with cage can be used at operating temperatures from  $-30^{\circ}\text{C}$  to  $+150^{\circ}\text{C}$ . In case of continuous operating temperatures above  $120^{\circ}\text{C}$ , please contact NBI application engineering department.

## Minimum load

Cylindrical roller bearings require a minimum radial load of more than 4% of the dynamic load rating  $C_r$  to avoid sliding friction.

## Equivalent dynamic bearing load

Since double row cylindrical roller bearings of series NN30 and NNU49 are non-locating bearings,

mientos diseñados para fijación axial, no son capaces de admitir cargas axiales.

$$P = F_r$$

### Carga estática equivalente

Para rodamientos de rodillos cilíndricos de doble hilera:

$$P_o = F_r$$

### Montaje

Durante la manipulación de rodamientos de rodillos cilíndricos de doble hilera de alta precisión se debe prestar atención particular a las instrucciones de ajuste y montaje de estos rodamientos.

Quando se montan rodamientos de rodillos cilíndricos de doble hilera con agujero cónico se puede ajustar el juego específico de funcionamiento mediante el desplazamiento del aro interior respecto del eje. El juego radial residual del rodamiento se deberá controlar mediante galgas de espesores.

### Dimensiones de los chaflanes

Los resaltes de las piezas de maquinaria adyacentes deben de estar diseñadas de tal forma que se garanticen el soporte axial requerido por los aros del rodamiento.

Los aros del rodamiento deben de contactar únicamente con las partes adyacentes con sus caras laterales.

Los chaflanes de los rodamientos no deben contactar con los radios de los chaflanes de los hombros del eje ni con los hombros del alojamiento.

Por lo tanto, el radio máximo del chaflán ( $r_g$ ) debe ser menor que el chaflán mínimo de los aros del rodamiento ( $r_s$ ) dados en la tabla de productos.

they are not able to accommodate any thrust loads.

$$P = F_r$$

### Equivalent static bearing load

For cylindrical roller bearings:

$$P_o = F_r$$

### Mounting

When handling high precision double row cylindrical roller bearings particular attention must be paid to the relevant instructions of fitting and mounting of these bearings.

When mounting double row cylindrical roller bearings with tapered bores, a specific clearance can be set and adjusted through the displacement of the Inner rings with respect to the axel.

The residual clearance of the bearing must be checked via sheet thickness gauges.

### Abutment and fillet dimensions

The shoulders on adjacent machine parts must be designed in such a way that the required axial support of the bearing rings is guaranteed.

The bearing rings must contact adjacent parts with their side faces only.

The bearing chamfers must not contact the shoulder fillet radii of either shaft or housing shoulders.

Therefore, the largest fillet radius ( $r_g$ ) must be kept smaller than the minimum fillet dimension of the bearing rings ( $r_s$ ) as listed in the product tables.

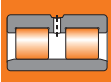

## 2.2 Rodamientos de doble hilera de rodillos cilíndricos Double row cylindrical roller bearings

Las recomendaciones para las dimensiones de las partes adyacentes son dadas en la norma DIN 5418.

Recommendations for the dimensions of adjacent parts are given in DIN 5418.

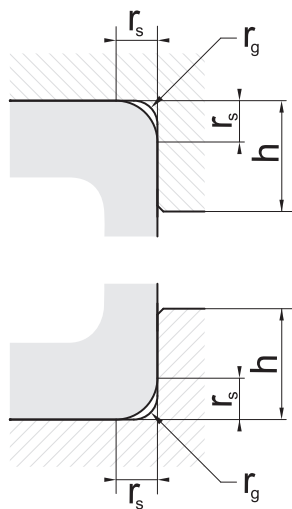
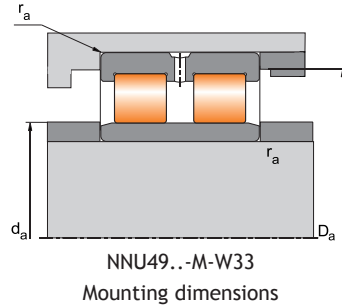
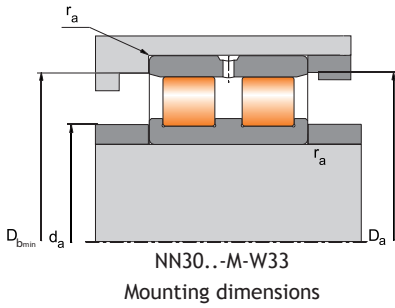

Fig. 2

rs min	rg max
1	1
1,1	1
1,5	1,5
2	2
2,1	2,1
3	2,5
4	3

Tabla 3. Table 3

**Dimensiones de montaje de rodamientos cilíndricos de doble hilera**  
**Mounting dimensions for double row cylindrical roller bearings**



Diámetro de eje Shaft diameter d [mm]	Tipo Type	Dimensiones de montaje Mounting dimensions			
		da min [mm]	Da max [mm]	Db min [mm]	ra max [mm]
30	NN3006	35	50	49	1
35	NN3007	40	57	56	1
40	NN3008	45	63	62	1
45	NN3009	50	70	69	1
50	NN3010	55	75	74	1
55	NN3011	61	84	82	1
60	NN3012	66	89	87	1
65	NN3013	71	94	92	1
70	NN3014	76	104	102	1
75	NN3015	81	109	107	1
80	NN3016	86	119	115	1
85	NN3017	91	124	120	1
90	NN3018	98	132	129	1,5
95	NN3019	103	137	134	1,5
100	NNU4920	106	134	-	1
100	NN3020	108	142	139	1,5
105	NNU4921	111	139	-	1
105	NN3021	114	151	148	2
110	NNU4922	116	144	-	1
110	NN3022	119	161	157	2
120	NNU4924	126	159	-	1
120	NN3024	129	171	167	2
130	NNU4926	138	172	-	1,5
130	NN3026	139	191	184	2
140	NNU4928	148	182	-	1,5
140	NN3028	149	201	194	2
150	NNU4930	159	201	-	2

Tabla 4. Table 4

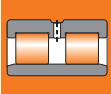

## 2.2 Rodamientos de doble hilera de rodillos cilíndricos Double row cylindrical roller bearings

### Dimensiones de montaje de rodamientos cilíndricos de doble hilera Mounting dimensions for double row cylindrical roller bearings

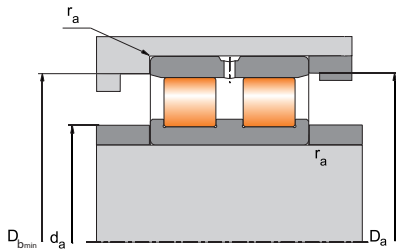

NN30...-M-W33  
Mounting dimensions

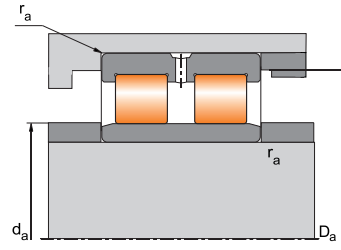

NNU49...-M-W33  
Mounting dimensions

Diámetro de eje Shaft diameter d [mm]	Tipo Type	Dimensiones de montaje Mounting dimensions			
		da min [mm]	Da max [mm]	Db min [mm]	ra max [mm]
150	NN3030	160	215	208	2,1
160	NNU4932	169	211	-	2
160	NN3032	170	230	222	2,1
170	NNU4934	179	221	-	2
170	NN3034	180	250	239	2,1
180	NNU4936	189	241	-	2
180	NN3036	190	270	258	2,1
190	NNU4938	199	251	-	2
190	NN3038	200	280	268	2,1
200	NNU4940	210	270	-	2
200	NN3040	210	300	285	2,1
220	NNU4944	230	290	-	2
220	NN3044	232	328	313	2,5
240	NNU4948	250	310	-	2
240	NN3048	252	348	334	2,5
260	NNU4952	270	350	-	2
260	NN3052	275	385	368	3
280	NNU4956	290	370	-	2
280	NN3056	295	405	388	3
300	NNU4960	312	408	-	2,5
300	NN3060	315	445	422	3
320	NNU4964	332	428	-	2,5
320	NN3064	335	465	442	3
340	NNU4968	352	448	-	2,5
340	NN3068	357	503	477	4
360	NNU4972	372	468	-	2,5
360	NN3072	377	523	497	4
380	NNU4976	395	505	-	3

(Continuación Tabla 4. Table 4 continuation)

**Dimensiones de montaje de rodamientos cilíndricos de doble hilera**  
**Mounting dimensions for double row cylindrical roller bearings**

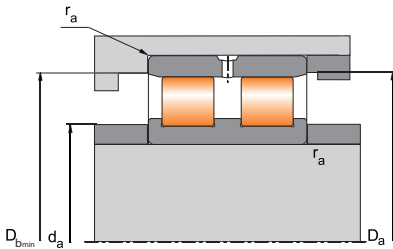

NN30..-M-W33  
Mounting dimensions

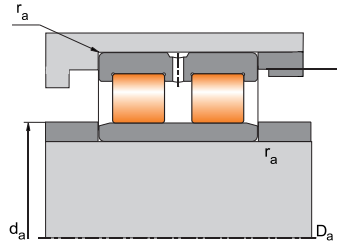

NNU49..-M-W33  
Mounting dimensions

Diámetro de eje Shaft diameter d [mm]	Tipo Type	Dimensiones de montaje Mounting dimensions			
		da min [mm]	Da max [mm]	Db min [mm]	ra max [mm]
380	NN3076	397	543	517	4
400	NNU4980	415	525	-	3
400	NN3080	417	583	553	4
420	NNU4984	435	545	-	3
420	NN3084	437	603	573	4
440	NNU4988	455	585	-	3
440	NN3088	463	627	601	5
460	NNU4992	475	605	-	3
460	NN3092	483	657	628	5
480	NNU4996	497	633	-	4
480	NN3096	503	677	648	5
500	NNU49/500	517	653	-	4
500	NN30/500	523	697	668	5

(Continuación Tabla 4. Table 4 continuation)

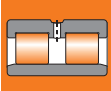

### Designaciones complementarias

Las tablas de producto recogen las configuraciones de rodamiento estandarizadas en la fecha de edición de este catálogo. Dichas configuraciones estandarizadas se reflejan en el correspondiente sufijo o sufijos de cada rodamiento.

En cualquier caso NBI puede ofrecer, bajo pedido, diseños alternativos, tanto los recogidos en la tabla siguiente como otros muchos cuya relación excede el propósito del presente catálogo y que podrán encontrarse en las publicaciones técnicas específicas de aplicaciones concretas o de series de rodamientos concretos.

En caso de requerir un diseño especial no recogido en estas páginas, consulten al Departamento Comercial de **NBI Bearings Europe**.

### Supplementary designations

The product tables show the standardized bearing configurations updated on the edition of this catalogue. These standardized configurations correspond to suffix or suffixes of each bearing.

In any case, NBI can offer, under requirement, alternative designs, comprising the ones showed in the following table or many others, whose mention exceeds the purpose of the present catalogue, and can be found in specific technical publications of concrete applications or series of specific bearings.

Should you need a special design not existent in these pages, please contact our Sales Department in **NBI Bearings Europe**.

Sufijo Suffix	Descripción	Description
<b>C1</b>	Juego radial menor que C2	<i>Radial internal clearance smaller than C2</i>
<b>C2</b>	Juego radial menor que el normal	<i>Radial internal clearance smaller than normal</i>
<b>C3</b>	Juego radial mayor que el normal	<i>Radial internal clearance larger than normal</i>
<b>P51</b>	Tolerancias de clase P5 y juego radial C1	<i>Tolerance class P5 and radial internal clearance C1</i>
<b>M</b>	Jaula de latón, guiada por los rodillos	<i>Solid brass cage, roller guided</i>
<b>K</b>	Agujero cónico, conicidad 1:12	<i>Tapered bore, taper 1:12</i>
<b>W33</b>	Con ranuras circunferenciales de engrase y agujeros de engrase en aro exterior	<i>With a circumferential lubrication groove and lubrication holes in outer ring</i>
<b>CE03</b>	Pavonados	<i>Black oxide coated</i>
<b>CE04</b>	Fosfatados	<i>Phosphate coated</i>
<b>CE05</b>	Recubrimiento protector contra la corrosión	<i>Anti corrosion coating</i>
<b>CE09</b>	Rodamientos para aplicaciones de aerogeneración	<i>Bearings for wind energy applications</i>
<b>ENH</b>	Rodamiento perteneciente a la línea E <sup>+</sup> Enhanced, cuyas cargas dinámicas corresponden a los valores de Cr E <sup>+</sup> . (Como referencia se muestran también, en las tablas de producto, los valores de Cr calculados según la norma ISO 281)	<i>E<sup>+</sup> Enhanced bearing series whose dynamic load rating corresponds to Cr E<sup>+</sup> values. (As reference, Cr values calculated according to ISO 281 are shown in the product tables)</i>

Tabla 5. Table 5





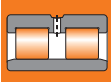

## 2.2 Rodamientos de doble hilera de rodillos cilíndricos Double row cylindrical roller bearings

### RODAMIENTOS LIBRES / NON-LOCATING BEARINGS

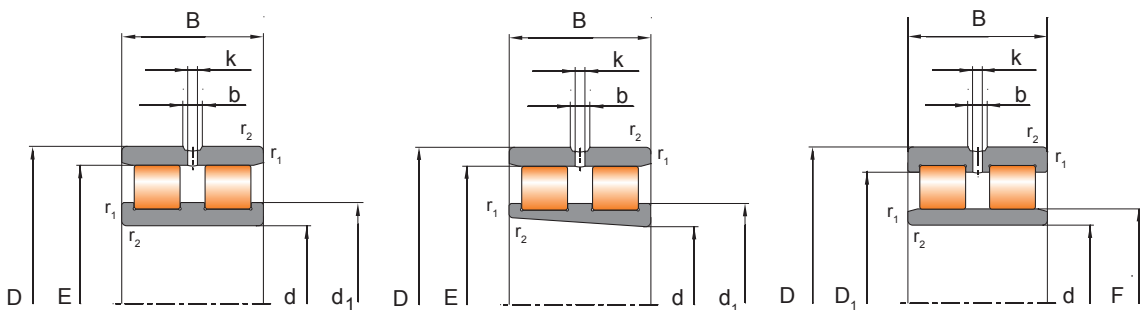

NN30...-M-W33-P51

NN30...-K-M-W33-P51

NNU49...-M-W33-P51

DIMENSIONES* BOUNDARY DIMENSIONS*			DESIGNACIÓN DESIGNATION	ε*	CAPACIDAD DE CARGA LOAD RATING (kN)		CARGA LÍMITE DE FATIGA / FATIGUE LIMIT LOAD (kN) Cu	
d	D	B			dyn. Cr	dyn. ε* Cr ε*		stat. Cor
30	55	19	NN3006-M-W33-P51	ε*	28,9	30,3	35,1	4
	55	19	NN3006-K-M-W33-P51	ε*	28,9	30,3	35,1	4
35	62	20	NN3007-M-W33-P51	ε*	36	38,2	46,8	5,5
	62	20	NN3007-K-M-W33-P51	ε*	36	38,2	46,8	5,5
40	68	21	NN3008-M-W33-P51	ε*	42,7	44,7	56,8	6,6
	68	21	NN3008-K-M-W33-P51	ε*	42,7	44,7	56,8	6,6
45	75	23	NN3009-M-W33-P51	ε*	49,6	52,5	68,4	7,9
	75	23	NN3009-K-M-W33-P51	ε*	49,6	52,5	68,4	7,9
50	80	23	NN3010-M-W33-P51	ε*	52,2	54,9	79,7	8,6
	80	23	NN3010-K-M-W33-P51	ε*	52,2	54,9	79,7	8,6
55	90	26	NN3011-M-W33-P51	ε*	68,6	71,9	99,6	12
	90	26	NN3011-K-M-W33-P51	ε*	68,6	71,9	99,6	12
60	95	26	NN3012-M-W33-P51	ε*	70,7	74,3	109	13,5
	95	26	NN3012-K-M-W33-P51	ε*	70,7	74,3	109	13,5
65	100	26	NN3013-M-W33-P51	ε*	72,7	76,5	116	14,2
	100	26	NN3013-K-M-W33-P51	ε*	72,7	76,5	116	14,2
70	110	30	NN3014-M-W33-P51	ε*	93	97	150	17,5
	110	30	NN3014-K-M-W33-P51	ε*	93	97	150	17,5
75	115	30	NN3015-M-W33-P51	ε*	95	99	155	18,4
	115	30	NN3015-K-M-W33-P51	ε*	95	99	155	18,4
80	125	34	NN3016-M-W33-P51	ε*	114	120	186	22,4
	125	34	NN3016-K-M-W33-P51	ε*	114	120	186	22,4
85	130	34	NN3017-M-W33-P51	ε*	119	125	201	23,5
	130	34	NN3017-K-M-W33-P51	ε*	119	125	201	23,5
90	140	37	NN3018-M-W33-P51	ε*	133	139	221	27
	140	37	NN3018-K-M-W33-P51	ε*	133	139	221	27
95	145	37	NN3019-M-W33-P51	ε*	137	143	233	29,2
	145	37	NN3019-K-M-W33-P51	ε*	137	143	233	29,2
100	140	40	NNU4920-M-W33-P51	ε*	123	129	255	30
	140	40	NNU4920-K-M-W33-P51	ε*	123	129	255	30
	150	37	NN3020-M-W33-P51	ε*	139	146	246	30
	150	37	NN3020-K-M-W33-P51	ε*	139	146	246	30

\*Dimensiones en mm. / \* Dimensions in mm.

\*\*Masa en kg. / \*\* Mass in kg.

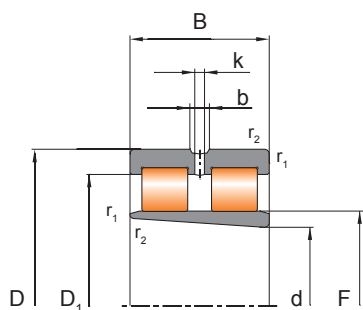

NNU49..-K-M-W33-P51

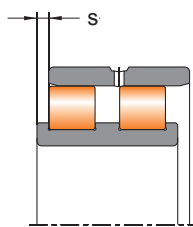

NN30..-M-W33-P51  
Axial Displacement (s)

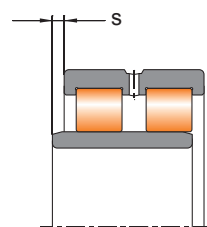

NNU49..-M-W33-P51  
Axial Displacement (s)

DESIGNACIÓN DESIGNATION	VELOCIDADES LIMITE SPEED RATINGS (rpm)		r <sub>1</sub> , r <sub>2</sub> (mm)	DIMENSIONES SECUNDARIAS SECONDARY DIMENSIONS							MASA** MASS*
	ng aceite <sup>^</sup> ng oil <sup>^</sup>	ng grasa ng grease		E	F	D <sub>1</sub>	d <sub>1</sub>	b	k	s	
NN3006-M-W33-P51	18.800	16.000	1	48,5	-	-	39,7	4,8	3,2	1,4	0,2
NN3006-K-M-W33-P51	18.800	16.000	1	48,5	-	-	39,7	4,8	3,2	1,4	0,19
NN3007-M-W33-P51	16.700	14.000	1	55	-	-	45,4	4,8	3,2	1,4	0,26
NN3007-K-M-W33-P51	16.700	14.000	1	55	-	-	45,4	4,8	3,2	1,4	0,25
NN3008-M-W33-P51	14.600	12.000	1	61	-	-	50,6	4,8	3,2	1,4	0,31
NN3008-K-M-W33-P51	14.600	12.000	1	61	-	-	50,6	4,8	3,2	1,4	0,3
NN3009-M-W33-P51	13.300	11.000	1	67,5	-	-	56,3	4,8	3,2	1,7	0,4
NN3009-K-M-W33-P51	13.300	11.000	1	67,5	-	-	56,3	4,8	3,2	1,7	0,39
NN3010-M-W33-P51	12.900	10.000	1	72,5	-	-	61,3	4,8	3,2	1,7	0,43
NN3010-K-M-W33-P51	12.900	10.000	1	72,5	-	-	61,3	4,8	3,2	1,7	0,42
NN3011-M-W33-P51	11.000	9.300	1,1	81	-	-	68,2	4,8	3,2	1,9	0,65
NN3011-K-M-W33-P51	11.000	9.300	1,1	81	-	-	68,2	4,8	3,2	1,9	0,63
NN3012-M-W33-P51	10.000	8.900	1,1	86,1	-	-	73,3	4,8	3,2	1,9	0,69
NN3012-K-M-W33-P51	10.000	8.900	1,1	86,1	-	-	73,3	4,8	3,2	1,9	0,67
NN3013-M-W33-P51	9.500	8.100	1,1	91	-	-	78,2	4,8	3,2	1,9	0,73
NN3013-K-M-W33-P51	9.500	8.100	1,1	91	-	-	78,2	4,8	3,2	1,9	0,71
NN3014-M-W33-P51	8.500	7.200	1,1	100	-	-	85,6	6,5	3,2	2,3	1
NN3014-K-M-W33-P51	8.500	7.200	1,1	100	-	-	85,6	6,5	3,2	2,3	1
NN3015-M-W33-P51	8.000	6.900	1,1	105	-	-	90,6	6,5	3,2	2,3	1,1
NN3015-K-M-W33-P51	8.000	6.900	1,1	105	-	-	90,6	6,5	3,2	2,3	1,1
NN3016-M-W33-P51	7.500	6.400	1,1	113	-	-	97	6,5	3,2	2,5	1,5
NN3016-K-M-W33-P51	7.500	6.400	1,1	113	-	-	97	6,5	3,2	2,5	1,5
NN3017-M-W33-P51	7.000	6.000	1,1	118	-	-	102	6,5	3,2	2,5	1,7
NN3017-K-M-W33-P51	7.000	6.000	1,1	118	-	-	102	6,5	3,2	2,5	1,6
NN3018-M-W33-P51	6.700	5.900	1,5	127	-	-	109,4	6,5	3,2	2,5	2,1
NN3018-K-M-W33-P51	6.700	5.900	1,5	127	-	-	109,4	6,5	3,2	2,5	2
NN3019-M-W33-P51	6.300	5.500	1,5	132	-	-	114,4	6,5	3,2	2,5	2,2
NN3019-K-M-W33-P51	6.300	5.500	1,5	132	-	-	114,4	6,5	3,2	2,5	2,1
NNU4920-M-W33-P51	6.300	5.500	1,1	-	113	125,8	-	6,5	3,2	2	2
NNU4920-K-M-W33-P51	6.300	5.500	1,1	-	113	125,8	-	6,5	3,2	2	1,9
NN3020-M-W33-P51	6.200	5.300	1,5	137	-	-	119,4	6,5	3,2	2,5	2,3
NN3020-K-M-W33-P51	6.200	5.300	1,5	137	-	-	119,4	6,5	3,2	2,5	2,2

<sup>^</sup> Velocidades válidas para cantidad mínima de aceite (proyección de gotas).  
<sup>^</sup> Speeds valid for minimum quantity of oil (oil - air).

\* Dimensiones en mm. / \* Dimensions in mm.  
\*\* Masa en kg. / \*\* Mass in kg.

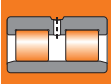

## 2.2 Rodamientos de doble hilera de rodillos cilíndricos Double row cylindrical roller bearings

### RODAMIENTOS LIBRES / NON-LOCATING BEARINGS

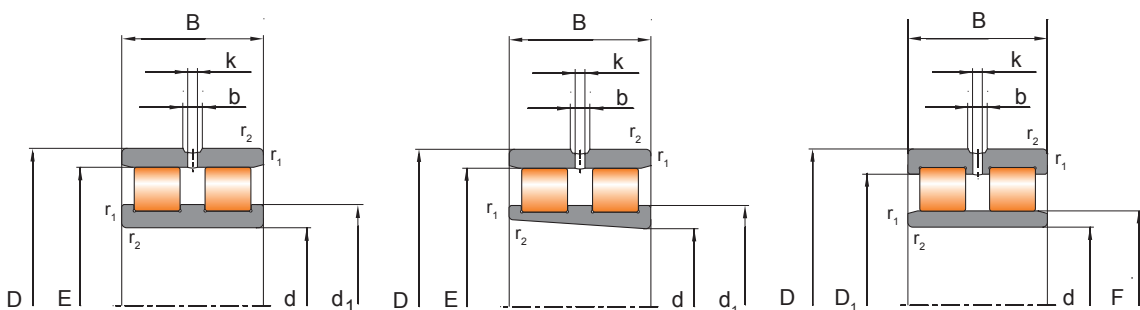

NN30...-M-W33-P51

NN30...-K-M-W33-P51

NNU49...-M-W33-P51

DIMENSIONES* BOUNDARY DIMENSIONS*			DESIGNACIÓN DESIGNATION	ε*	CAPACIDAD DE CARGA LOAD RATING (kN)			CARGA LÍMITE DE FATIGA / FATIGUE LIMIT LOAD (kN) Cu
d	D	B			dyn. Cr	dyn. ε* Cr ε*	stat. Cor	
105	145	40	NNU4921-M-W33-P51	ε*	125	130	260	31
	145	40	NNU4921-K-M-W33-P51	ε*	125	130	260	31
160	160	41	NN3021-M-W33-P51	ε*	180	190	306	36
	160	41	NN3021-K-M-W33-P51	ε*	180	190	306	36
110	150	40	NNU4922-M-W33-P51	ε*	126	132	270	32,6
	150	40	NNU4922-K-M-W33-P51	ε*	126	132	270	32,6
	170	45	NN3022-M-W33-P51	ε*	210	220	360	42
	170	45	NN3022-K-M-W33-P51	ε*	210	220	360	42
120	165	45	NNU4924-M-W33-P51	ε*	168	176	340	39
	165	45	NNU4924-K-M-W33-P51	ε*	168	176	340	39
	180	46	NN3024-M-W33-P51	ε*	218	230	390	44,3
	180	46	NN3024-K-M-W33-P51	ε*	218	230	390	44,3
130	180	50	NNU4926-M-W33-P51	ε*	178	187	390	44,4
	180	50	NNU4926-K-M-W33-P51	ε*	178	187	390	44,4
	200	52	NN3026-M-W33-P51	ε*	274	287	498	55
	200	52	NN3026-K-M-W33-P51	ε*	274	287	498	55
140	190	50	NNU4928-M-W33-P51	ε*	179	190	400	44,7
	190	50	NNU4928-K-M-W33-P51	ε*	179	190	400	44,7
	210	53	NN3028-M-W33-P51	ε*	183	298	520	59
	210	53	NN3028-K-M-W33-P51	ε*	283	298	520	59
150	210	60	NNU4930-M-W33-P51	ε*	314	329	655	72,3
	210	60	NNU4930-K-M-W33-P51	ε*	314	329	655	72,3
	225	56	NN3030-M-W33-P51	ε*	320	335	571	63,5
	225	56	NN3030-K-M-W33-P51	ε*	320	335	571	63,5
160	220	60	NNU4932-M-W33-P51	ε*	316	333	680	74,5
	220	60	NNU4932-K-M-W33-P51	ε*	316	333	680	74,5
	240	60	NN3032-M-W33-P51	ε*	355	374	658	70
	240	60	NN3032-K-M-W33-P51	ε*	355	374	658	70
170	230	60	NNU4934-M-W33-P51	ε*	323	340	695	75,4
	230	60	NNU4934-K-M-W33-P51	ε*	323	340	695	75,4
	260	67	NN3034-M-W33-P51	ε*	429	450	800	85,5
	260	67	NN3034-K-M-W33-P51	ε*	429	450	800	85,5

\*Dimensiones en mm. / \* Dimensions in mm.

\*\*Masa en kg. / \*\* Mass in kg.

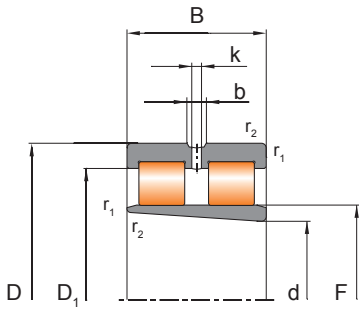

NNU49...-K-M-W33-P51

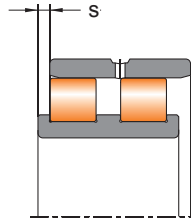

NN30...-M-W33-P51  
Axial Displacement (s)

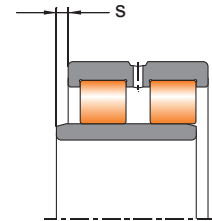

NNU49...-M-W33-P51  
Axial Displacement (s)

	DESIGNACIÓN DESIGNATION	VELOCIDADES LIMITE SPEED RATINGS (rpm)		r <sub>1</sub> , r <sub>2</sub> (mm)	DIMENSIONES SECUNDARIAS SECONDARY DIMENSIONS							MASA** MASS*
		ng aceite <sup>^</sup> ng oil <sup>^</sup>	ng grasa ng grease		E	F	D <sub>1</sub>	d <sub>1</sub>	b	k	s	
1	NNU4921-M-W33-P51	6.200	5.300	1,1	-	118	130,8	-	6,5	3,2	1,5	2,1
2	NNU4921-K-M-W33-P51	6.200	5.300	1,1	-	118	130,8	-	6,5	3,2	1,5	2
3	NN3021-M-W33-P51	5.600	5.000	2	146	-	-	125,2	6,5	3,2	2,6	2,8
4	NN3021-K-M-W33-P51	5.600	5.000	2	146	-	-	125,2	6,5	3,2	2,6	2,7
5	NNU4922-M-W33-P51	6.000	5.300	1,1	-	123	135,8	-	6,5	3,2	1,5	2,2
6	NNU4922-K-M-W33-P51	6.000	5.300	1,1	-	123	135,8	-	6,5	3,2	1,5	2,1
7	NN3022-M-W33-P51	5.300	4.800	2	155	-	-	132,6	6,5	3,2	2,9	3,7
8	NN3022-K-M-W33-P51	5.300	4.800	2	155	-	-	132,6	6,5	3,2	2,9	3,6
9	NNU4924-M-W33-P51	5.300	4.700	1,1	-	134,5	150,5	-	6,5	3,2	1,5	3
10	NNU4924-K-M-W33-P51	5.300	4.700	1,1	-	134,5	150,5	-	6,5	3,2	1,5	2,9
11	NN3024-M-W33-P51	5.000	4.400	2	165	-	-	142,6	6,5	3,2	3,1	4
12	NN3024-K-M-W33-P51	5.000	4.400	2	165	-	-	142,6	6,5	3,2	3,1	3,9
13	NNU4926-M-W33-P51	4.800	4.100	1,5	-	146	162	-	6,5	3,2	3	4,1
14	NNU4926-K-M-W33-P51	4.800	4.100	1,5	-	146	162	-	6,5	3,2	3	3,9
15	NN3026-M-W33-P51	4.500	3.900	2	182	-	-	156,4	9,5	4,8	3,4	5,9
16	NN3026-K-M-W33-P51	4.500	3.900	2	182	-	-	156,4	9,5	4,8	3,4	5,7
17	NNU4928-M-W33-P51	4.500	3.800	1,5	-	156	172	-	6,5	3,2	3	4,3
18	NNU4928-K-M-W33-P51	4.500	3.800	1,5	-	156	172	-	6,5	3,2	3	4,1
19	NN3028-M-W33-P51	4.300	3.600	2	192	-	-	166,4	9,5	4,8	3,4	6,3
20	NN3028-K-M-W33-P51	4.300	3.600	2	192	-	-	166,4	9,5	4,8	3,4	6,1
21	NNU4930-M-W33-P51	4.300	3.700	2	-	168,5	191,9	-	6,5	3,2	3	6,6
22	NNU4930-K-M-W33-P51	4.300	3.700	2	-	168,5	191,9	-	6,5	3,2	3	6,3
23	NN3030-M-W33-P51	4.000	3.500	2,1	206	-	-	178,8	9,5	4,8	3,7	7,6
24	NN3030-K-M-W33-P51	4.000	3.500	2,1	206	-	-	178,8	9,5	4,8	3,7	7,4
25	NNU4932-M-W33-P51	4.000	3.500	2	-	178,5	200,9	-	6,5	3,2	3,1	7,1
26	NNU4932-K-M-W33-P51	4.000	3.500	2	-	178,5	200,9	-	6,5	3,2	3,1	6,8
27	NN3032-M-W33-P51	3.800	3.300	2,1	219	-	-	190,2	9,5	4,8	4,2	9,4
28	NN3032-K-M-W33-P51	3.800	3.300	2,1	219	-	-	190,2	9,5	4,8	4,2	9,1
29	NNU4934-M-W33-P51	3.800	3.300	2	-	188,5	210,9	-	6,5	3,2	2,3	7,3
30	NNU4934-K-M-W33-P51	3.800	3.300	2	-	188,5	210,9	-	6,5	3,2	2,3	7
31	NN3034-M-W33-P51	3.600	3.100	2,1	236	-	-	204	9,5	4,8	4,5	12,8
32	NN3034-K-M-W33-P51	3.600	3.100	2,1	236	-	-	204	9,5	4,8	4,5	12,4

<sup>^</sup> Velocidades válidas para cantidad mínima de aceite (proyección de gotas).  
<sup>^</sup> Speeds valid for minimum quantity of oil (oil - air).

\* Dimensiones en mm. / \* Dimensions in mm.  
\*\* Masa en kg. / \*\* Mass in kg.

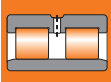

## 2.2 Rodamientos de doble hilera de rodillos cilíndricos Double row cylindrical roller bearings

### RODAMIENTOS LIBRES / NON-LOCATING BEARINGS

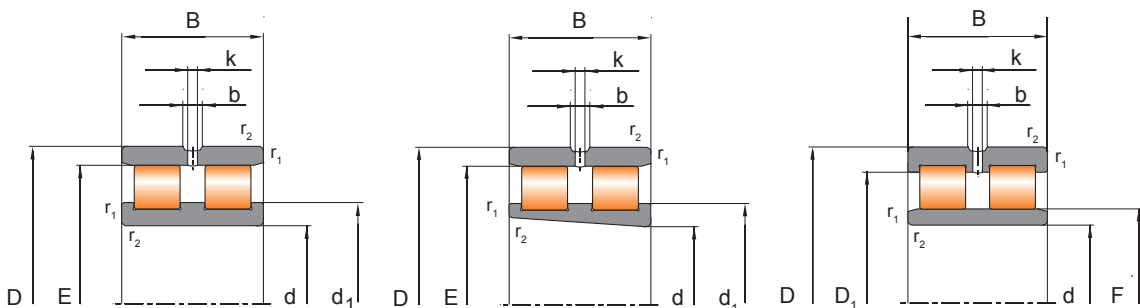

NN30...-M-W33-P51

NN30...-K-M-W33-P51

NNU49...-M-W33-P51

DIMENSIONES* BOUNDARY DIMENSIONS*			DESIGNACIÓN DESIGNATION	ε*	CAPACIDAD DE CARGA LOAD RATING (kN)			CARGA LÍMITE DE FATIGA / FATIGUE LIMIT LOAD (kN) Cu
d	D	B			dyn. Cr	dyn. ε* Cr ε*	stat. Cor	
180	250	69	NNU4936-M-W33-P51	ε*	387	403	850	90
	250	69	NNU4936-K-M-W33-P51	ε*	387	403	850	90
	280	74	NN3036-M-W33-P51	ε*	542	565	1.000	104
	280	74	NN3036-K-M-W33-P51	ε*	542	565	1.000	104
190	260	69	NNU4938-M-W33-P51	ε*	385	405	880	93
	260	69	NNU4938-K-M-W33-P51	ε*	385	405	880	93
	290	75	NN3038-M-W33-P51	ε*	562	590	1.050	110
	290	75	NN3038-K-M-W33-P51	ε*	562	590	1.050	110
200	280	80	NNU4940-M-W33-P51	ε*	462	485	1.040	108
	280	80	NNU4940-K-M-W33-P51	ε*	462	485	1.040	108
	310	82	NN3040-M-W33-P51	ε*	625	654	1.170	120
	310	82	NN3040-K-M-W33-P51	ε*	625	654	1.170	120
220	300	80	NNU4944-M-W33-P51	ε*	488	512	1.140	118
	300	80	NNU4944-K-M-W33-P51	ε*	488	512	1.140	118
	340	90	NN3044-M-W33-P51	ε*	761	807	1.460	144
	340	90	NN3044-K-M-W33-P51	ε*	761	807	1.460	144
240	320	80	NNU4948-M-W33-P51	ε*	500	529	1.210	131
	320	80	NNU4948-K-M-W33-P51	ε*	500	529	1.200	131
	360	92	NN3048-M-W33-P51	ε*	810	843	1.560	156
	360	92	NN3048-K-M-W33-P51	ε*	810	843	1.560	156
260	360	100	NNU4952-M-W33-P51	ε*	712	748	1.700	166
	360	100	NNU4952-K-M-W33-P51	ε*	712	748	1.700	166
	400	104	NN3052-M-W33-P51	ε*	1.000	1.025	1.980	188
	400	104	NN3052-K-M-W33-P51	ε*	1.000	1.025	1.980	188
280	380	100	NNU4956-M-W33-P51	ε*	730	765	1.800	171
	380	100	NNU4956-K-M-W33-P51	ε*	730	765	1.800	171
	420	106	NN3056-M-W33-P51	ε*	1.000	1.080	2.080	200
	420	106	NN3056-K-M-W33-P51	ε*	1.000	1.080	2.080	200
300	420	118	NNU4960-M-W33-P51	ε*	970	1.040	2.360	230
	420	118	NNU4960-K-M-W33-P51	ε*	970	1.040	2.360	230
	460	118	NN3060-M-W33-P51	ε*	1.200	1.250	2.400	230
	460	118	NN3060-K-M-W33-P51	ε*	1.200	1.250	2.400	230

\*Dimensiones en mm. / \* Dimensions in mm.

\*\*Masa en kg. / \*\* Mass in kg.

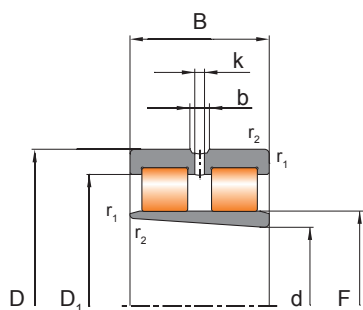

**NNU49...-K-M-W33-P51**

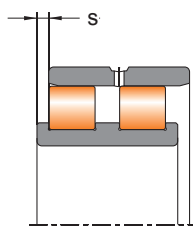

**NN30...-M-W33-P51**  
Axial Displacement (s)

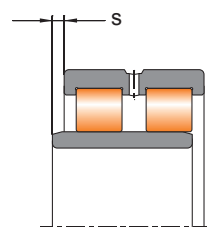

**NNU49...-M-W33-P51**  
Axial Displacement (s)

	DESIGNACIÓN DESIGNATION	VELOCIDADES LIMITE SPEED RATINGS (rpm)		r <sub>1</sub> , r <sub>2</sub> (mm)	DIMENSIONES SECUNDARIAS SECONDARY DIMENSIONS							MASA** MASS*
		ng aceite <sup>^</sup> ng oil <sup>^</sup>	ng grasa ng grease		E	F	D <sub>1</sub>	d <sub>1</sub>	b	k	s	
	NNU4936-M-W33-P51	3.600	3.000	2	-	202	226	-	9,5	4,8	3,9	10,9
	NNU4936-K-M-W33-P51	3.600	3.000	2	-	202	226	-	9,5	4,8	3,9	10,5
	NN3036-M-W33-P51	3.400	2.800	2,1	255	-	-	218,2	12,2	6,3	4,8	16,7
	NN3036-K-M-W33-P51	3.400	2.800	2,1	255	-	-	218,2	12,2	6,3	4,8	16,2
	NNU4938-M-W33-P51	3.400	2.800	2	-	212	236	-	9,5	4,8	2,6	11
	NNU4938-K-M-W33-P51	3.400	2.800	2	-	212	236	-	9,5	4,8	2,6	10,6
	NN3038-M-W33-P51	3.100	2.600	2,1	265	-	-	228,2	12,2	6,3	4,8	17,5
	NN3038-K-M-W33-P51	3.100	2.600	2,1	265	-	-	228,2	12,2	6,3	4,8	17
	NNU4940-M-W33-P51	3.100	2.600	2,1	-	225	252,2	-	12,2	6,3	3,4	15,7
	NNU4940-K-M-W33-P51	3.100	2.600	2,1	-	225	252,2	-	12,2	6,3	3,4	15
	NN3040-M-W33-P51	3.000	2.400	2,1	282	-	-	242	12,2	6,3	5,3	22,7
	NN3040-K-M-W33-P51	3.000	2.400	2,1	282	-	-	242	12,2	6,3	5,3	22
	NNU4944-M-W33-P51	2.800	2.400	2,1	-	245	272,2	-	12,2	6,3	3,4	17,3
	NNU4944-K-M-W33-P51	2.800	2.400	2,1	-	245	272,2	-	12,2	6,3	3,4	16,6
	NN3044-M-W33-P51	2.700	2.200	3	310	-	-	265,2	15	8	4,5	28,9
	NN3044-K-M-W33-P51	2.700	2.200	3	310	-	-	265,2	15	8	4,5	28
	NNU4948-M-W33-P51	2.700	2.200	2,1	-	265	292,2	-	12,2	6,3	3,4	18,2
	NNU4948-K-M-W33-P51	2.700	2.200	2,1	-	265	292,2	-	12,2	6,3	3,4	17,4
	NN3048-M-W33-P51	2.400	2.000	3	330	-	-	285,2	15	8	6	32,5
	NN3048-K-M-W33-P51	2.400	2.000	3	330	-	-	285,2	15	8	6	31,5
	NNU4952-M-W33-P51	2.400	2.000	2,1	-	292	325,6	-	15	8	4	31,8
	NNU4952-K-M-W33-P51	2.400	2.000	2,1	-	292	325,6	-	15	8	4	30,5
	NN3052-M-W33-P51	2.400	1.900	4	364	-	-	312,8	15	8	6,5	46,4
	NN3052-K-M-W33-P51	2.400	1.900	4	364	-	-	312,8	15	8	6,5	45
	NNU4956-M-W33-P51	2.200	1.900	2,1	-	312	345,6	-	15	8	4	33,9
	NNU4956-K-M-W33-P51	2.200	1.900	2,1	-	312	345,6	-	15	8	4	32,5
	NN3056-M-W33-P51	2.100	1.800	4	384	-	-	332,8	15	8	6,8	50
	NN3056-K-M-W33-P51	2.100	1.800	4	384	-	-	332,8	15	8	6,8	48,4
	NNU4960-M-W33-P51	2.000	1.800	3	-	339	379	-	17,7	9,5	5	52
	NNU4960-K-M-W33-P51	2.000	1.800	3	-	339	379	-	17,7	9,5	5	50
	NN3060-M-W33-P51	1.900	1.600	4	418	-	-	360,4	17,7	9,5	7,5	70
	NN3060-K-M-W33-P51	1.900	1.600	4	418	-	-	360,4	17,7	9,5	7,5	68

<sup>^</sup> Velocidades válidas para cantidad mínima de aceite (proyección de gotas).  
<sup>^</sup> Speeds valid for minimum quantity of oil (oil - air).

\* Dimensiones en mm. / \* Dimensions in mm.  
\*\* Masa en kg. / \*\* Mass in kg.

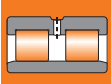

## 2.2 Rodamientos de doble hilera de rodillos cilíndricos Double row cylindrical roller bearings

### RODAMIENTOS LIBRES / NON-LOCATING BEARINGS

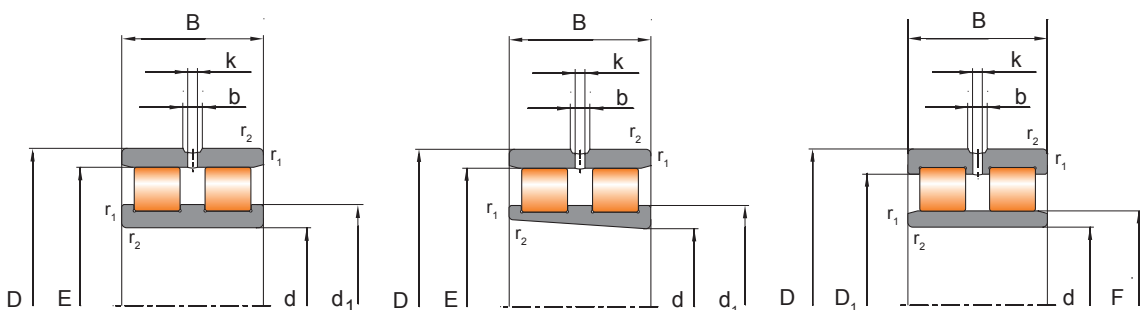

NN30...-M-W33-P51

NN30...-K-M-W33-P51

NNU49...-M-W33-P51

DIMENSIONES* BOUNDARY DIMENSIONS*			DESIGNACION DESIGNATION	E*	CAPACIDAD DE CARGA LOAD RATING (kN)		CARGA LIMITE DE FATIGA / FATIGUE LIMIT LOAD (kN)	
d	D	B			dyn. Cr	dyn. E* Cr E*	stat. Cor	Cu
320	440	118	NNU4964-M-W33-P51	E*	980	1.060	2.530	240
	440	118	NNU4964-K-M-W33-P51	E*	980	1.060	2.530	240
480	121	118	NN3064-M-W33-P51	E*	1.200	1.320	2.600	250
	480	121	NN3064-K-M-W33-P51	E*	1.200	1.320	2.600	250
340	460	118	NNU4968-M-W33-P51	E*	1.000	1.100	2.650	247
	460	118	NNU4968-K-M-W33-P51	E*	1.000	1.100	2.650	247
	520	133	NN3068-M-W33-P51	E*	1.500	1.640	3.250	300
	520	133	NN3068-K-M-W33-P51	E*	1.500	1.640	3.250	300
360	480	118	NNU4972-M-W33-P51	E*	1.000	1.130	2.800	250
	480	118	NNU4972-K-M-W33-P51	E*	1.000	1.130	2.800	250
	540	134	NN3072-M-W33-P51	E*	1.550	1.670	3.370	325
	540	134	NN3072-K-M-W33-P51	E*	1.550	1.670	3.370	325
380	520	140	NNU4976-M-W33-P51	E*	1.350	1.430	3.600	325
	520	140	NNU4976-K-M-W33-P51	E*	1.350	1.430	3.600	325
	560	135	NN3076-M-W33-P51	E*	1.600	1.710	3.460	330
	560	135	NN3076-K-M-W33-P51	E*	1.600	1.710	3.460	330
400	540	140	NNU4980-M-W33-P51	E*	1.350	1.490	3.800	340
	540	140	NNU4980-K-M-W33-P51	E*	1.350	1.490	3.800	340
	600	148	NN3080-M-W33-P51	E*	2.000	2.160	4.500	390
	600	148	NN3080-K-M-W33-P51	E*	2.000	2.160	4.500	390
420	560	140	NNU4984-M-W33-P51	E*	1.400	1.530	4.000	360
	560	140	NNU4984-K-M-W33-P51	E*	1.400	1.530	4.000	360
	620	150	NN3084-M-W33-P51	E*	2.000	2.120	4.500	390
	620	150	NN3084-K-M-W33-P51	E*	2.000	2.120	4.500	390
440	600	160	NNU4988-M-W33-P51	E*	1.800	1.900	5.000	400
	600	160	NNU4988-K-M-W33-P51	E*	1.800	1.900	5.000	400
	650	157	NN3088-M-W33-P51	E*	2.300	2.450	5.100	430
	650	157	NN3088-K-M-W33-P51	E*	2.300	2.450	5.100	430
460	620	160	NNU4992-M-W33-P51	E*	2.000	2.110	5.500	475
	620	160	NNU4992-K-M-W33-P51	E*	2.000	2.110	5.500	475
	680	163	NN3092-M-W33-P51	E*	2.400	2.600	5.480	460
	680	163	NN3092-K-M-W33-P51	E*	2.400	2.600	5.480	460

\*Dimensiones en mm. / \* Dimensions in mm.

\*\*Masa en kg. / \*\* Mass in kg.



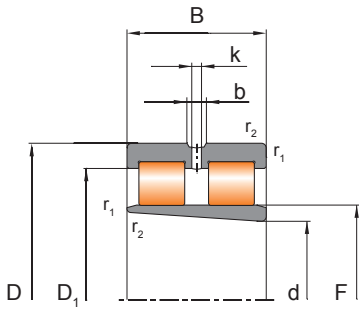

**NNU49..-K-M-W33-P51**

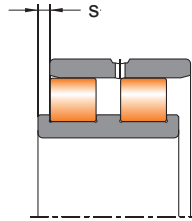

**NN30..-M-W33-P51**  
Axial Displacement (s)

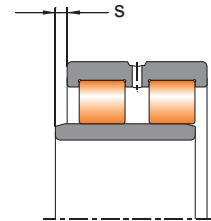

**NNU49..-M-W33-P51**  
Axial Displacement (s)

	DESIGNACIÓN DESIGNATION	VELOCIDADES LIMITE SPEED RATINGS (rpm)		$r_1, r_2$ (min)	DIMENSIONES SECUNDARIAS SECONDARY DIMENSIONS							MASA** MASS*
		ng aceite <sup>^</sup> ng oil <sup>^</sup>	ng grasa ng grease		E	F	$D_1$	$d_1$	b	k	s	
	NNU4964-M-W33-P51	1.900	1.700	3	-	359	399	-	17,7	9,5	8,1	55
	NNU4964-K-M-W33-P51	1.900	1.700	3	-	359	399	-	17,7	9,5	8,1	53
	NN3064-M-W33-P51	1.900	1.600	4	438	-	-	380,4	17,7	9,5	7,9	74
	NN3064-K-M-W33-P51	1.900	1.600	4	438	-	-	380,4	17,7	9,5	7,9	72
	NNU4968-M-W33-P51	1.800	1.500	3	-	379	419	-	17,7	9,5	5	57
	NNU4968-K-M-W33-P51	1.800	1.500	3	-	379	419	-	17,7	9,5	5	55
	NN3068-M-W33-P51	1.600	1.400	5	473	-	-	409	17,7	9,5	8,7	98
	NN3068-K-M-W33-P51	1.600	1.400	5	473	-	-	409	17,7	9,5	8,7	94,7
	NNU4972-M-W33-P51	1.800	1.500	3	-	399	439	-	17,7	9,5	5	59
	NNU4972-K-M-W33-P51	1.800	1.500	3	-	399	439	-	17,7	9,5	5	56,5
	NN3072-M-W33-P51	1.600	1.300	5	493	-	-	429	17,7	9,5	8,7	106
	NN3072-K-M-W33-P51	1.600	1.300	5	493	-	-	429	17,7	9,5	8,7	103
	NNU4976-M-W33-P51	1.700	1.400	4	-	426	470	-	17,7	9,5	5,5	88
	NNU4976-K-M-W33-P51	1.700	1.400	4	-	426	470	-	17,7	9,5	5,5	84,5
	NN3076-M-W33-P51	1.700	1.400	5	513	-	-	449	17,7	9,5	9	113
	NN3076-K-M-W33-P51	1.700	1.400	5	513	-	-	449	17,7	9,5	9	109
	NNU4980-M-W33-P51	1.500	1.300	4	-	446	490,8	-	17,7	9,5	5,5	93
	NNU4980-K-M-W33-P51	1.500	1.300	4	-	446	490,8	-	17,7	9,5	5,5	89
	NN3080-M-W33-P51	1.400	1.200	5	549	-	-	477	17,7	9,5	9,5	143
	NN3080-K-M-W33-P51	1.400	1.200	5	549	-	-	477	17,7	9,5	9,5	138
	NNU4984-M-W33-P51	1.400	1.200	4	-	466	510,8	-	17,7	9,5	5,5	97
	NNU4984-K-M-W33-P51	1.400	1.200	4	-	466	510,8	-	17,7	9,5	5,5	93
	NN3084-M-W33-P51	1.400	1.100	5	569	-	-	497	17,7	9,5	10	150
	NN3084-K-M-W33-P51	1.400	1.100	5	569	-	-	497	17,7	9,5	10	145
	NNU4988-M-W33-P51	1.400	1.200	4	-	490	544,4	-	17,7	9,5	5,8	137
	NNU4988-K-M-W33-P51	1.400	1.200	4	-	490	544,4	-	17,7	9,5	5,8	131
	NN3088-M-W33-P51	1.300	1.100	6	597	-	-	520,2	23,5	12,5	10,3	178
	NN3088-K-M-W33-P51	1.300	1.100	6	597	-	-	520,2	23,5	12,5	10,3	172
	NNU4992-M-W33-P51	1.300	1.100	4	-	510	564,4	-	17,7	9,5	5,8	140
	NNU4992-K-M-W33-P51	1.300	1.100	4	-	510	564,4	-	17,7	9,5	5,8	134
	NN3092-M-W33-P51	1.200	1.000	6	624	-	-	544	23,5	12,5	10,5	200
	NN3092-K-M-W33-P51	1.200	1.000	6	624	-	-	544	23,5	12,5	10,5	194

<sup>^</sup> Velocidades válidas para cantidad mínima de aceite (proyección de gotas).  
<sup>^</sup> Speeds valid for minimum quantity of oil (oil - air).

\* Dimensiones en mm. / \* Dimensions in mm.  
\*\* Masa en kg. / \*\* Mass in kg.

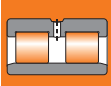

## 2.2 Rodamientos de doble hilera de rodillos cilíndricos Double row cylindrical roller bearings

### RODAMIENTOS LIBRES / NON-LOCATING BEARINGS

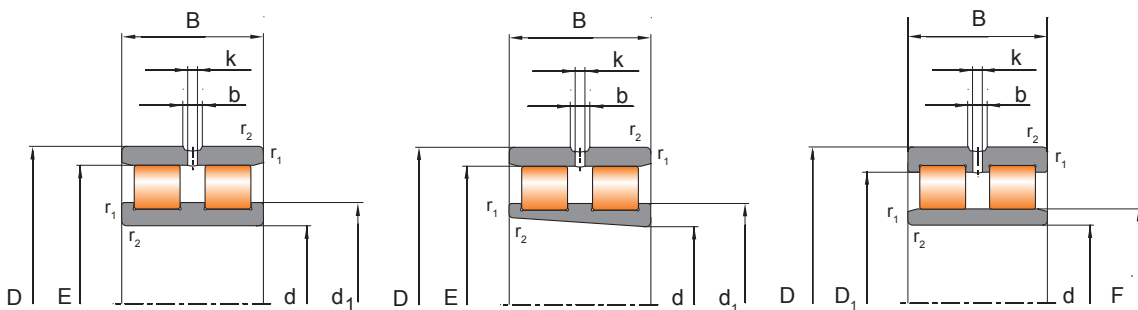

NN30...-M-W33-P51

NN30...-K-M-W33-P51

NNU49...-M-W33-P51

DIMENSIONES* BOUNDARY DIMENSIONS*			DESIGNACIÓN DESIGNATION	E*	CAPACIDAD DE CARGA LOAD RATING (kN)			CARGA LÍMITE DE FATIGA / FATIGUE LIMIT LOAD (kN)	
d	D	B			dyn. Cr	dyn. E*	stat. Cor	Cr E*	Cu
480	650	170	NNU4996-M-W33-P51	E*	2.200	2.350	6.100	500	
	650	170	NNU4996-K-M-W33-P51	E*	2.200	2.350	6.100	500	
	700	165	NN3096-M-W33-P51	E*	2.500	2.700	5.800	630	
	700	165	NN3096-K-M-W33-P51	E*	2.500	2.700	5.800	630	
500	670	170	NNU49/500-M-W33-P51	E*	2.200	2.330	6.100	525	
	670	170	NNU49/500-K-M-W33-P51	E*	2.200	2.330	6.100	525	
	720	167	NN30/500-M-W33-P51	E*	2.500	2.700	5.850	490	
	720	167	NN30/500-K-M-W33-P51	E*	2.500	2.700	5.850	490	

\*Dimensiones en mm. / \* Dimensions in mm.  
\*\*Masa en kg. / \*\* Mass in kg.

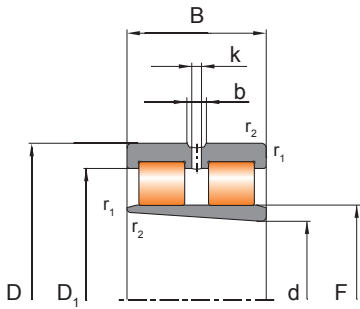

**NNU49..-K-M-W33-P51**

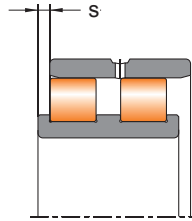

**NN30..-M-W33-P51**  
Axial Displacement (s)

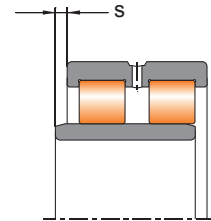

**NNU49..-M-W33-P51**  
Axial Displacement (s)

	DESIGNACIÓN DESIGNATION	VELOCIDADES LIMITE SPEED RATINGS (rpm)		$r_1, r_2$ (mm)	DIMENSIONES SECUNDARIAS SECONDARY DIMENSIONS							MASA** MASS*
		ng aceite <sup>^</sup> ng oil <sup>^</sup>	ng grasa ng grease		E	F	$D_1$	$d_1$	b	k	s	
	NNU4996-M-W33-P51	1.300	1.100	5	-	534	593	-	17,7	9,5	6	165
	NNU4996-K-M-W33-P51	1.300	1.100	5	-	534	593	-	17,7	9,5	6	158
	NN3096-M-W33-P51	1.300	1.000	6	644	-	-	564	23,5	12,5	11	213
	NN3096-K-M-W33-P51	1.300	1.000	6	644	-	-	564	23,5	12,5	11	206
	NNU49/500-M-W33-P51	1.100	960	5	-	554	613	-	23,5	12,5	6	171
	NNU49/500-K-M-W33-P51	1.100	960	5	-	554	613	-	23,5	12,5	6	164
	NN30/500-M-W33-P51	1.100	980	6	664	-	-	584	23,5	12,5	11,5	219
	NN30/500-K-M-W33-P51	1.100	980	6	664	-	-	584	23,5	12,5	11,5	212

<sup>^</sup>Velocidades válidas para cantidad mínima de aceite (proyección de gotas).  
<sup>^</sup>Speeds valid for minimum quantity of oil (oil - air).

\*Dimensiones en mm. / \*Dimensions in mm.  
\*\*Masa en kg. / \*\*Mass in kg.



# 2.3

de una hilera completamente llena de rodillos cilíndricos.  
full complement cylindrical roller bearings

SEMI-LOGGING BEARINGS



BEARINGS EUROPE **NBI**

DIMENSIONES BOUNDARY DIMENSIONS mm	DESIGNACION DESIGNATION	DESIGNACION ALTERNATIVA ALTERNATIVE DESIGNATION	E	CAPACIDAD DE CARGA (MN) LOAD RATING (MN)		CARGA POR AREA (MPa)		ESPECIFICACION SPECIFICATION		PRECISION LIMIT PRECISION LIMIT		UNFINISHED DIMENSIONS UNFINISHED DIMENSIONS		MÁS BASES
				Appl. E	Appl. E	Appl. E	Appl. E	mm	mm	mm	mm	mm	mm	
70	100	30 NCF2014-V	S18-2014	E	142,4	190	175	29,4	NCF2014-V	2,250	2,400	1,1	1,1	100-20
100	120	31 NU2214-VH	S18-2214	E	171,2	190	225	29,4	NCF2014-V	2,250	2,400	1,1	1,1	100-20
150	51 NU2214-VH	S18-2214	E	99,9	160	190	160	29,4	NCF2014-V	2,250	2,400	1,1	1,1	100-20
75	100	19 NCF2014-V	S18-2014	E	140,8	160	160	29,4	NCF2014-V	2,250	2,400	1,1	1,1	100-20
100	55 NU2215-VH	S18-2215	E	103	160	190	160	29,4	NCF2014-V	2,250	2,400	1,1	1,1	100-20
150	31 NCF2014-V	S18-2014	E	102,1	170	225	29,4	NCF2014-V	2,250	2,400	1,1	1,1	100-20	
100	110	19 NCF2014-V	S18-2014	E	102,1	170	225	29,4	NCF2014-V	2,250	2,400	1,1	1,1	100-20
125	24 NCF2014-V	S18-2014	E	102,1	170	225	29,4	NCF2014-V	2,250	2,400	1,1	1,1	100-20	
140	33 NCF2014-V	S18-2014	E	102,1	170	225	29,4	NCF2014-V	2,250	2,400	1,1	1,1	100-20	
170	58 NU2216-VH	S18-2216	E	102,1	170	225	29,4	NCF2014-V	2,250	2,400	1,1	1,1	100-20	
85	120	22 NCF2014-V	S18-2014	E	102,1	170	225	29,4	NCF2014-V	2,250	2,400	1,1	1,1	100-20
130	24 NCF2014-V	S18-2014	E	102,1	170	225	29,4	NCF2014-V	2,250	2,400	1,1	1,1	100-20	
150	34 NCF2014-V	S18-2014	E	102,1	170	225	29,4	NCF2014-V	2,250	2,400	1,1	1,1	100-20	
160	36 NCF2014-V	S18-2014	E	102,1	170	225	29,4	NCF2014-V	2,250	2,400	1,1	1,1	100-20	
160	35 NU2217-VH	S18-2217	E	102,1	170	225	29,4	NCF2014-V	2,250	2,400	1,1	1,1	100-20	
90	125	22 NCF2014-V	S18-2014	E	102,1	170	225	29,4	NCF2014-V	2,250	2,400	1,1	1,1	100-20
140	37 NCF2014-V	S18-2014	E	102,1	170	225	29,4	NCF2014-V	2,250	2,400	1,1	1,1	100-20	
160	45 NCF2014-V	S18-2014	E	102,1	170	225	29,4	NCF2014-V	2,250	2,400	1,1	1,1	100-20	
180	64 NU2218-VH	S18-2218	E	102,1	170	225	29,4	NCF2014-V	2,250	2,400	1,1	1,1	100-20	
95	130	22 NCF2014-V	S18-2014	E	102,1	170	225	29,4	NCF2014-V	2,250	2,400	1,1	1,1	100-20
170	43 NCF2014-V	S18-2014	E	102,1	170	225	29,4	NCF2014-V	2,250	2,400	1,1	1,1	100-20	
200	67 NU2219-VH	S18-2219	E	102,1	170	225	29,4	NCF2014-V	2,250	2,400	1,1	1,1	100-20	
100	140	24 NCF2014-V	S18-2014	E	102,1	170	225	29,4	NCF2014-V	2,250	2,400	1,1	1,1	100-20
150	37 NCF2014-V	S18-2014	E	102,1	170	225	29,4	NCF2014-V	2,250	2,400	1,1	1,1	100-20	
160	46 NCF2014-V	S18-2014	E	102,1	170	225	29,4	NCF2014-V	2,250	2,400	1,1	1,1	100-20	
215	73 NU2220-VH	S18-2220	E	102,1	170	225	29,4	NCF2014-V	2,250	2,400	1,1	1,1	100-20	
110	150	24 NCF2014-V	S18-2014	E	102,1	170	225	29,4	NCF2014-V	2,250	2,400	1,1	1,1	100-20
170	45 NCF2014-V	S18-2014	E	102,1	170	225	29,4	NCF2014-V	2,250	2,400	1,1	1,1	100-20	
200	53 NCF2014-V	S18-2014	E	102,1	170	225	29,4	NCF2014-V	2,250	2,400	1,1	1,1	100-20	
240	80 NU2221-VH	S18-2221	E	102,1	170	225	29,4	NCF2014-V	2,250	2,400	1,1	1,1	100-20	
120	165	21 NCF2014-V	S18-2014	E	102,1	170	225	29,4	NCF2014-V	2,250	2,400	1,1	1,1	100-20
180	46 NCF2014-V	S18-2014	E	102,1	170	225	29,4	NCF2014-V	2,250	2,400	1,1	1,1	100-20	

RODAMIENTOS DE RODILLOS CILÍNDRICOS • CYLINDRICAL ROLLER BEARINGS

\* Dimensiones en mm. / \* Dimensions in mm.  
\*\* Masa en kg. / \*\* Mass in kg.



Rodamientos completamente llenos  
de rodillos cilíndricos  
*Full complement cylindrical roller bearings*



## 2.3 Rodamientos completamente llenos de rodillos cilíndricos *Full complement cylindrical roller bearings*

índice

Características técnicas .....	88
Variantes de diseño estandarizadas .....	89
Tolerancias .....	91
Juego radial interno .....	92
Juego radial interno no estándar.....	92
Carga mínima .....	92
Carga dinámica equivalente .....	92
Capacidad de carga axial dinámica .....	94
Carga estática equivalente .....	94
Dimensiones de los chaflanes .....	94
Diseño de los asientos de los rodamientos como pistas de rodadura .....	95
Designaciones complementarias .....	97
Tabla de dimensiones: NCF-V, NJ23-VH .....	98
Tabla de dimensiones: NNCF50-V, NNC-V, NNCL-V .....	108
Tabla de dimensiones: RN-V, RNN50-V .....	116

index

Technical characteristics .....	88
Standard design variants .....	89
Tolerances .....	91
Internal radial clearance .....	92
Non-standardized internal clearance.....	92
Minimum load .....	92
Equivalent dynamic bearing load .....	92
Dynamic axial load carrying capacity .....	94
Equivalent static bearing load.....	94
Abutment and fillet dimensions .....	94
Design of bearing seats as raceways .....	95
Supplementary designations .....	97
Dimensions table: NCF-V, NJ23-VH .....	98
Dimensions table: NNCF50-V, NNC-V, NNCL-V .....	108
Dimensions table: RN-V, RNN50-V.....	116

### NBI E<sup>+</sup> - SERIES CON SUPERIORES CAPACIDADES DE CARGA



NBI ha combinado los últimos avances en investigación de materiales y en metalurgia con su experiencia en diseño y fabricación de rodamientos para crear una nueva línea de rodamientos de rodillos cilíndricos con excepcionales prestaciones.

La mejora en la rugosidad de las pistas de rodadura y la optimización de los perfiles de las mismas, junto con el empleo de rodillos de un grado de precisión superior minimizan el rozamiento y optimizan la distribución de la carga. La circulación del lubricante también se favorece con un nuevo diseño de los flancos de guiado de los rodillos en las pistas.

La capacidad de aceptar desalineamientos y la capacidad de carga axial han aumentado como consecuencia de estas mejoras. Para todas las cuestiones acerca de las series NBI E<sup>+</sup>, consulte con nuestro departamento de ingeniería.

### NBI E<sup>+</sup> - SERIES WITH ENHANCED LOAD RATING CHARACTERISTICS

NBI has combined the latest achievements of metallurgy and material research with its expertise in bearing design and manufacturing to create a new line of cylindrical roller bearings with additional benefits.

Improvements in internal design features optimize the internal load distribution. Lubricant flow is enhanced by newly defined geometry of the bearings functional surfaces.

The ability to accept misalignments plus the axial load carrying capacity have increased due to these improvements. This technical progress allows for working with higher dynamic load ratings. For all questions you may have regarding the NBI E<sup>+</sup> series, please feel free to contact our engineering team.

NCF-V



NJ23-VH



NNCF50-V



NNC-V



NNCL-V



RN-V



RNN50-V



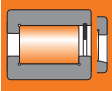

## RODAMIENTOS COMPLETAMENTE LLENOS DE RODILLOS CILÍNDRICOS

### Características técnicas

Los rodamientos completamente llenos de rodillos cilíndricos prescinden de la jaula para incorporar el máximo número de rodillos. Son, por tanto apropiados para soportar cargas radiales extremadamente elevadas y tienen una gran rigidez. No obstante, debido a sus condiciones cinemáticas, no pueden funcionar a las mismas altas velocidades que los rodamientos de rodillos cilíndricos con jaula.

Los rodamientos completamente llenos de rodillos cilíndricos NBI están disponibles tanto como rodamientos libres, de apoyo o fijos como en diseños de simple y doble hilera.

## FULL COMPLEMENT CYLINDRICAL ROLLER BEARINGS

### Technical Characteristics

Full complement cylindrical roller bearings are designed without cages in order to have the maximum possible number of rolling elements. Therefore, they feature extremely high radial load carrying capacities and provide high rigidity. However, due to their kinematics, they have a lower speed ability as cylindrical roller bearings fitted with cages.

NBI full complement cylindrical roller bearings are available as single and double row designs as non-locating, semi-locating and locating bearings.

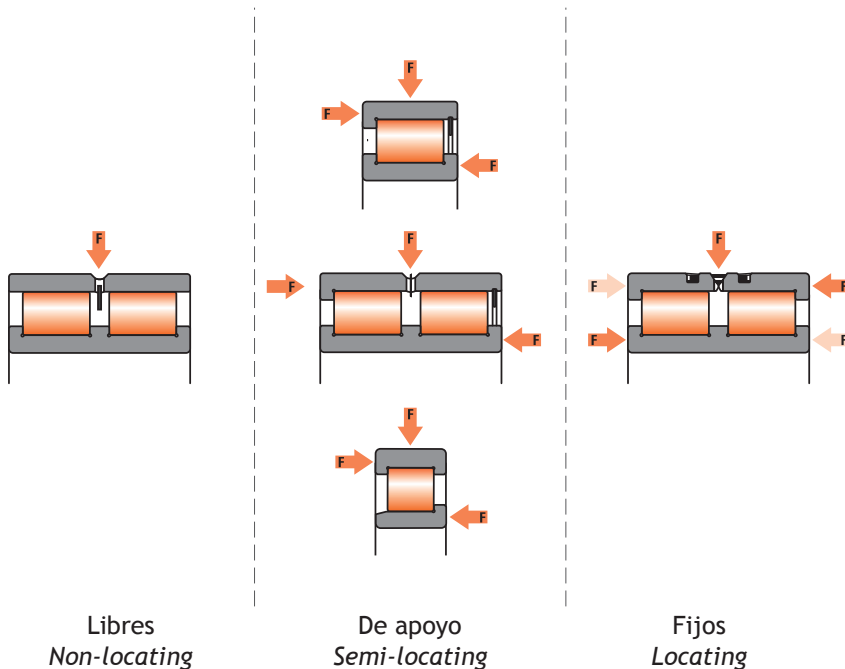

Fig. 1



## Variantes de diseños estandarizadas

Los rodamientos NBI llenos de rodillos cilíndricos están disponibles en varios diseños estándares básicos.

Las variantes de diseños más importantes son explicadas a continuación.

## Standard design variants

NBI full complement cylindrical roller bearings are available in several basic designs as standard.

The more important design variants are being introduced below.

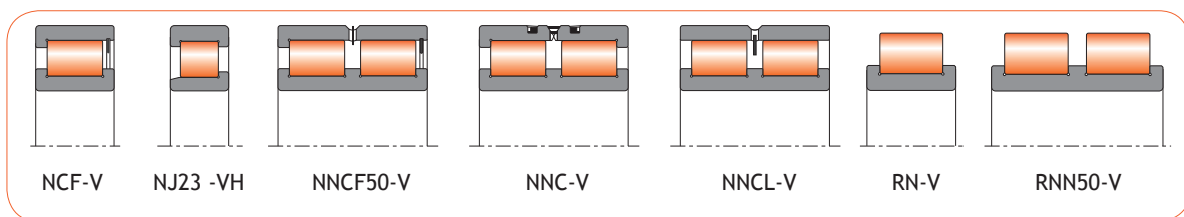

Fig. 2

## Rodamientos de una hilera completamente llenos de rodillos cilíndricos

Los rodamientos de una hilera completamente llenos de rodillos cilíndricos NBI actúan como rodamientos de apoyo.

### Diseño NCF-V

Los rodamientos de diseño NCF-V tienen dos pestañas integrales en el aro interior y una pestaña integral en el aro exterior.

Son capaces de soportar no sólo elevadas fuerzas radiales sino también fuerzas axiales en una dirección y por tanto pueden guiar ejes en esa dirección axial actuando como rodamientos de apoyo en la dirección opuesta.

Un dispositivo de retención (anillo de retención) en el aro exterior sin flanco mantiene el rodamiento montado durante la manipulación y el transporte. Este dispositivo de retención no debe someterse a cargas axiales.

El juego axial máximo del rodamiento se muestra en la tabla de rodamientos.

## Single row full complement cylindrical roller bearings

NBI standard single row full complement roller bearings are semi-locating bearings.

### NCF-V Design

NCF-V design bearings have two integral flanges on the inner ring and one integral flange on the outer ring.

They can support high radial forces but thrust forces in one direction and can therefore act as semi-locating bearings.

A retaining device (snap ring) in the flangeless side of the outer ring keeps the bearing assembly together during handling and transport. This retaining device must not be subjected to thrust loads.

The maximum possible axial displacement of the bearing is provided in the product tables.

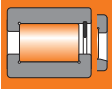

### Diseño NJ23-VH

La serie de rodamientos NJ23-VH es un tipo de rodamiento completamente lleno de rodillos cilíndricos separable. Su particular geometría interior permite alojar un complemento de auto-retención de los rodillos. Este complemento permite desalojar el aro interior sin desalojar los rodillos.

Esta serie de rodamientos está especialmente adaptada para aplicaciones de baja velocidad con cargas muy elevadas o cargas de impacto.

Este tipo rodamiento de apoyo puede soportar grandes fuerzas radiales junto con fuerzas axiales en una sola dirección.

### Rodamientos de doble hilera completamente llenos de rodillos cilíndricos

Los rodamientos NBI de doble hilera de rodillos cilíndricos están siendo fabricados en varios diseños estándares incluyendo una versión completamente obturada.

Todos los diseños son no desmontables y pueden ser lubricados por medio de una ranura y agujeros de engrase presentes en la ranura de lubricación del aro exterior (sufijo W33).

### Diseño NNCF50-V

Este tipo de rodamientos tiene tres pestañas integrales en el aro interior y una sola pestaña integral en el aro exterior, lo que le permite garantizar una fijación axial del eje en un sentido.

Un dispositivo de retención (anillo de retención) en el aro exterior sin flanco mantiene el rodamiento montado durante la manipulación y el transporte. Este dispositivo de retención no debe someterse a cargas axiales.

### Diseño NNC-V

Los rodamientos completamente llenos de rodillos cilíndricos de diseño NNC-V tienen tres pestañas integrales en el aro interior y un aro exterior partido con dos pestañas integrales.

### NJ23-VH design

The bearings series NJ23-VH is a separable full complement cylindrical roller bearing type. Its particular internal geometry allows for a self retaining roller complement. This allows for removing the inner ring without having the rollers dropping out.

This bearing series is particularly suitable for low speed applications operating at high loads or shock loads.

These semi-locating bearings can support high radial loads plus single direction acting thrust forces.

### Double row full complement cylindrical roller bearings

NBI double row full complement roller bearings are being produced in various designs as standard including a full sealed variant.

All double row full complement bearings are non-separable and can be lubricated via a lubrication groove and lubrication holes in the outer ring (suffix W33).

### NNCF50-V Design

This semi-locating bearing type has three integral flanges on the inner ring and one integral flange on the outer ring enabling the bearing to provide shaft guidance in one direction.

A retaining device (snap ring) in the flangeless side of the outer ring keeps the bearing assembly together during handling and transport. This retaining device must not be subjected to thrust loads.

### NNC-V Design

NNC-V design full complement cylindrical roller bearings are locating bearings. They have three integral flanges on the inner ring and an axially split outer ring having two integrated flanges.

Por motivos de fabricación, el aro exterior está partido axialmente. Las dos mitades del aro exterior están unidas por medio de un mecanismo de abrazaderas circulares. Este mecanismo de retención no debe sufrir cargas axiales.

### Diseño NNCL-V

Los rodamientos de diseño NNCL-V son rodamientos libres de doble hilera completamente llenos de rodillos cilíndricos. Tienen tres pestañas integrales en el aro interior y un aro exterior plano sin pestañas.

El conjunto del rodamiento se mantiene unido para montaje y transporte por un dispositivo de retención en el aro exterior.

### Diseño RN-V y RNN-V

Los rodamientos de diseño RN-V y RNN-V son rodamientos sin aro exterior de una y dos hileras respectivamente. Se utilizan habitualmente en el caso de aplicaciones en el que el espacio disponible para el rodamiento sea limitado, (por ejemplo, cajas de engranajes). Este tipo de diseño permite que los rodillos rueden directamente sobre la superficie de contacto con el alojamiento.

En este caso, la superficie de contacto de las partes adyacentes utilizadas como pista de rodadura debe ser templada y rectificada, como lo están habitualmente las pistas de rodadura de los rodamientos.

### Tolerancias

Los rodamientos completamente de rodillos cilíndricos NBI se fabrican, como estándar, con una tolerancia Normal (PN).

Se pueden suministrar bajo pedido rodamientos fabricados con tolerancias geométricas y dimensionales más ajustadas, P6, P5, P4 etc.

Para conseguir valores detallados de tolerancias ver el capítulo *Datos de rodamientos y tolerancias*.

For manufacturing reasons the outer ring is radially split. The two outer ring halves are being held together by circular clamping devices. These devices, however, must not be subjected to thrust load.

### NNCL-V Design

NNCL-V design full complement cylindrical roller bearings are double row non locating bearings. This design features three integral flanges on the inner ring and a plain outer ring without flanges.

The assembled bearing is kept together for the purpose of mounting and transport via a retention device attached to the outer ring.

### RN-V and RNN-V Design

RN-V and RNN-V designs full complement cylindrical roller bearings are single and double row bearings without outer ring, respectively. They are usually used in the case of bearing applications where the space available is limited, (i.e. gear boxes). This bearing design types allow the rollers to run directly onto the contacting housing surface.

In this case, in such bearing arrangements the contacting surface parts must be hardened and ground as for regular bearing raceways.

### Tolerances

NBI full complement cylindrical roller bearings are produced to tolerance class PN as standard.

NBI bearings are also produced to closer tolerances, such as tolerance classes P6, P5 and P4 etc to customers order.

For obtaining detailed values on tolerances refer to the chapter *Bearing data and Tolerances*.

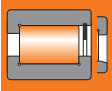

### Juego radial interno

Los rodamientos completamente llenos de rodillos cilíndricos se fabrican, de forma estándar, con juego interno normal (grupo CN).

Los rodamientos completamente llenos de rodillos cilíndricos NBI también se pueden fabricar en otros grupos de tolerancia bajo pedido. Estos valores están estandarizados y son conformes a los estándares internacionales en vigor, DIN 620 parte 4 e ISO 5753-1991. Los valores de los grupos de juego interno de los rodamientos completamente llenos de rodillos cilíndricos NBI se listan en la tabla 2 (pág. 93).

### Juego radial interno no estándar

Los rodamientos completamente llenos de rodillos de NBI pueden fabricarse con un juego especial bajo pedido. Esto incluye la posibilidad de fabricar rodamientos con un juego más restrictivo que el rango de juegos.

### Carga mínima

Los rodamientos necesitan una carga radial mínima para prevenir una fricción excesiva. La carga mínima para los rodamientos completamente llenos de rodillos NBI debe ser del 4% de su capacidad de carga dinámica Cr.

### Carga dinámica equivalente

En el caso de que los rodamientos completamente llenos de rodillos cilíndricos sin la actuación de cargas axiales, se aplica:

$$P = F_r$$

En el caso de rodamientos completamente llenos de rodillos de simple o de doble hilera que reciben cargas axiales, aplicar la siguiente formula:

$$\text{Si } \frac{F_a}{F_r} \leq e, \text{ entonces: } P = F_r$$

$$\text{O si } \frac{F_a}{F_r} > e, \text{ entonces: } P = X \cdot F_r + Y \cdot F_a$$

### Internal radial clearance

NBI full complement cylindrical roller bearings are produced to normal internal clearance group (group CN) as standard.

NBI cylindrical roller bearings can be also produced to other internal clearance groups to customers order. The clearance values correspond, as far as they are standardized, to the relevant international standards DIN 620 part 4 and ISO 5753 - 1991. The values of the internal clearance groups of single and double row NBI cylindrical roller bearings are listed in table 2 (page 93).

### Non-standardized internal clearance

NBI full complement cylindrical roller bearings can also be produced with individually defined special internal clearances to customers order. This includes the possibility of producing bearings with a clearance restricted to a part of the full clearance range, i.e. C3H etc.

### Minimum load

Rolling bearings require a sufficient minimum radial load to prevent excessive sliding friction. Particularly full complement cylindrical roller bearings require a minimum radial load of more than 4% of the dynamic load rating Cr.

### Equivalent dynamic bearing load

For non-locating type full complement cylindrical roller bearings and all other only radially loaded full complement cylindrical roller bearings apply:

$$P = F_r$$

In the case of single and double row full complement cylindrical roller bearings accepting thrust loads, the following formula applies:

$$\text{if } \frac{F_a}{F_r} \leq e, \text{ then: } P = F_r$$

$$\text{or if } \frac{F_a}{F_r} > e, \text{ then: } P = X \cdot F_r + Y \cdot F_a$$

Series de rodamientos <i>Bearing series</i>	Factores de cálculo / <i>Calculation factors</i>		
	e	X	Y
NCF-V (18)	0,2	0,92	0,6
NCF-V (22, 23, 28, 29, 30)	0,3	0,92	0,4
NJ23-VH	0,3	0,92	0,4
NNCF50-V, NNC-V	0,15	0,92	0,53

Tabla 1. Table 1

Juego radial interno en  $\mu\text{m}$  de los rodamientos completamente llenos de rodillos cilíndricos NBI  
*Internal clearance in  $\mu\text{m}$  of NBI full complement cylindrical roller bearings*

Juego radial <i>Clearance group</i>	Diámetro de eje / <i>Bore diameter (mm)</i>														
	$\leq$	0	24	30	40	50	65	80	100	120	140	160	180	200	225
C1	min	5	5	5	5	5	10	10	10	10	10	10	15	15	15
	max	15	15	15	18	20	25	30	30	35	35	40	45	50	50
C2	min	0	0	5	5	10	10	15	15	15	20	25	35	45	45
	max	25	25	30	35	40	45	50	55	60	70	75	90	105	110
CN	min	20	20	25	30	40	40	50	50	60	70	75	90	105	110
	max	45	45	50	60	70	75	85	90	105	120	125	145	165	175
C3	min	35	35	45	50	60	65	75	85	100	115	120	140	160	170
	max	60	60	70	80	90	100	110	125	145	165	170	195	220	235
C4	min	50	50	60	70	80	90	105	125	145	165	170	195	220	235
	max	75	75	85	100	110	125	140	165	190	215	220	250	280	300
C5	min	75	75	85	100	110	125	140	165	190	215	220	250	280	300
	max	100	100	110	130	140	160	175	205	235	265	270	305	340	365

Juego radial <i>Clearance group</i>	Diámetro de eje / <i>Bore diameter (mm)</i>														
	$\leq$	250	280	315	355	400	450	500	560	630	710	800	900	1000	1120
C1	min	20	20	20	25	25	25	25	30	30	35	35	35	50	230
	max	55	60	65	75	85	95	100	110	130	140	160	180	200	470
C2	min	55	55	65	100	110	110	120	140	145	150	180	200	220	230
	max	125	130	145	190	210	220	240	260	285	310	350	390	430	470
CN	min	125	130	145	190	210	220	240	260	285	310	350	390	430	470
	max	195	205	225	280	310	330	360	380	425	470	520	580	640	710
C3	min	190	200	225	280	310	330	360	380	425	470	520	580	640	710
	max	260	275	305	370	410	440	480	500	565	630	690	770	850	950
C4	min	260	275	305	370	410	440	480	500	565	630	690	770	850	950
	max	330	350	385	460	510	550	600	620	705	790	860	960	1.060	1.190
C5	min	330	350	385	460	510	550	600	620	705	790	860	960	1.060	1.510
	max	400	425	465	550	610	660	720	740	845	950	1.030	1.150	1.270	1.750

Tabla 2. Table 2

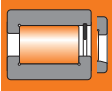

### Capacidad de carga axial dinámica

Los rodamientos completamente llenos de rodillos son diseñados principalmente para soportar cargas radiales. Algunos diseños pueden soportar cargas axiales actuando en una o en ambas direcciones con un límite.

Las fuerzas axiales aplicadas a los rodamientos de rodillos cilíndricos generan fricción entre los extremos de los rodillos y los flancos de las pistas de guiado.

Por lo tanto, una lubricación óptima es crucial. Además, todas las cargas axiales generan un momento de giro sobre los cilindros.

Esto requiere una carga radial adicional para asegurar una eficiente función del rodamiento.

Las fuerzas axiales aplicadas al rodamiento no pueden exceder estos límites:

En rodamientos de una hilera:

$$F_{\text{amax}} \leq 0,5 \cdot F_r$$

En el caso de doble hilera:

$$F_{\text{amax}} \leq 0,2 \cdot F_r$$

### Carga estática equivalente

En los rodamientos completamente llenos de rodillos cilíndricos NBI, de simple y doble hilera se cumple:

$$P = F_r$$

### Dimensiones de los chaflanes

Los resaltes de las piezas de maquinaria adyacentes se deben diseñar de forma que garanticen el soporte axial requerido por los aros de los rodamientos.

Los aros de los rodamientos deben contactar con las piezas adyacentes solo a través de sus caras laterales.

### Dynamic axial load carrying capacity

Full complement cylindrical roller bearings are primarily designed to accommodate radial loads. Several designs are also suitable to accept thrust forces acting in one or both directions to a limited extent.

Thrust forces applied to cylindrical roller bearings generate sliding friction between the roller end faces and the guiding flanges.

Hence, an optimum lubrication is crucial. Furthermore, every thrust load creates a tilting moment on the rollers.

This requires an additional radial loading to ensure an effective function of the bearing.

The thrust forces applied to the bearing must not exceed the following limits:

For single row bearings:

$$F_{\text{amax}} \leq 0,5 \cdot F_r$$

For double row bearings:

$$F_{\text{amax}} \leq 0,2 \cdot F_r$$

### Equivalent static bearing load

For NBI single and double row full complement cylindrical roller bearings applies:

$$P = F_r$$

### Abutment and fillet dimensions

The shoulders on adjacent machine parts must be designed in such a way that the required thrust support of the bearing rings is guaranteed.

The bearing rings must contact adjacent parts with their side faces only.

The bearing chamfers must not contact the shoul-

Los chaflanes de los rodamientos no deben contactar con los redondeos del eje ni del alojamiento.

Por tanto, el radio máximo del chaflán ( $r_g$ ) debe ser menor que el chaflán mínimo de los aros del rodamiento ( $r_s$ ), tal y como se expone en las tablas de rodamientos.

En la norma DIN 5418 se proporcionan directrices para dimensionar las partes adyacentes.

### Diseño de los asientos de los rodamientos como pistas de rodadura

En aplicaciones donde el espacio está limitado, puede ser ventajoso utilizar rodamientos de una o dos hileras completamente llenos de rodillos cilíndricos sin aro exterior para reducir el tamaño de la disposición de rodamientos.

En estos casos los rodillos circulan directamente sobre la superficie del alojamiento. Esta superficie de contacto deben estar templadas y rectificadas, al igual que las pistas de rodadura de los rodamientos.

Los diseños habituales para estas aplicaciones son los de las series RNN50-V (doble hilera) y RN-V (simple hilera).

La superficie de contacto en el eje o alojamiento se debe fabricar con una tolerancia g6 o k6, respectivamente, de acuerdo a los campos de tolerancias ISO.

Los diámetros de los resaltes de guiado en los alojamientos deben concordar con los respectivos diámetros de las pestañas de los rodamientos ( $D_1$ ), dadas en las tablas de producto.

Para más información acerca del diseño de las pistas de rodadura léase el capítulo *Diseño del alojamiento de los rodamientos*.

der fillet radii of shaft or housing shoulders.

Therefore, the largest fillet radius ( $r_g$ ) must be kept smaller than the minimum fillet dimension of the bearing rings ( $r_s$ ) as listed in the product tables.

Recommendations for the dimensions of adjacent parts are given in DIN 5418.

### Design of bearing seats as raceways

In applications with limited space it may be advantageous using a single or double row full complement cylindrical roller bearing in order to save on sectional height.

In these cases, the rollers run directly on the surfaces of housing. This contacting surface must be hardened and ground as for bearing raceways.

Typical types for these applications are RNN50-V series (double row) or RN-V series (single row).

The contacting surface on housing acting as raceway must be produced to ISO tolerance field g6 and K6 respectively.

The diameters of the guiding flanges on housing must be in accordance with the respective shoulder diameters ( $D_1$ ), as given by the product tables.

For detailed information on the design layout of raceways see chapter *Design of bearing location*.

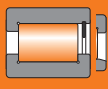

## 2.3 Rodamientos completamente llenos de rodillos cilíndricos

### Full complement cylindrical roller bearings

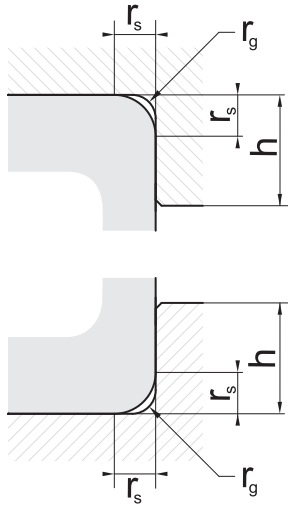

Fig. 3

rs min	rg max	$h_{min}$
		Series de rodamientos Bearing Series
		18, 22, 29, 30, 48, 49, 50
0,3	0,3	1
0,3	1	1,6
0,6	0,6	1,6
1	1	2,3
1,1	1	3
1,5	1,5	3,5
2	2	4,4
2,1	2,1	2,1
3	2,5	6,2
4	3	7,3
5	4	9

Tabla 3. Table 3

## NOTAS / NOTES



### Designaciones complementarias

Las tablas de producto recogen las configuraciones de rodamiento estandarizadas en la fecha de edición de este catálogo. Dichas configuraciones estandarizadas se reflejan en el correspondiente sufijo o sufijos de cada rodamiento.

En cualquier caso NBI puede ofrecer, bajo pedido, diseños alternativos, tanto los recogidos en la tabla siguiente como otros muchos cuya relación excede el propósito del presente catálogo y que podrán encontrarse en las publicaciones técnicas específicas de aplicaciones concretas o de series de rodamientos concretos.

En caso de requerir un diseño especial no recogido en estas páginas, consulten al Departamento Comercial de NBI Bearings Europe.

### Supplementary designations

The product tables show the standardized bearing configurations updated on the edition of this catalogue. These standardized configurations correspond to suffix or suffixes of each bearing.

In any case, NBI can offer, under requirement, alternative designs, comprising the ones showed in the following table or many others, whose mention exceeds the purpose of the present catalogue, and can be found in specific technical publications of concrete applications or series of specific bearings.

Should you need a special design not existent in these pages, please contact our Sales Department in NBI Bearings Europe.

Sufijo Suffix	Descripción	Description
<b>C2</b>	Juego radial menor que el normal	Radial internal clearance smaller than normal
<b>C1</b>	Juego radial menor que C2	Radial internal clearance smaller than C2
<b>C3</b>	Juego radial mayor que el normal	Radial internal clearance larger than normal
<b>C4</b>	Juego radial mayor que C3	Radial internal clearance larger than C3
<b>V</b>	Completamente lleno de rodillos, sin jaula	Full complement of rollers, without cage
<b>VH</b>	Completamente lleno de rodillos, sin jaula, rodillos auto retenibles	Full complement of rollers, without cage, self-retaining
<b>PE</b>	Diseño interno optimizado para incrementar la capacidad de admitir desalineamientos	Modified internal design to increase the misalignment capacity
<b>2S</b>	Rodamientos especialmente seleccionados para ser utilizados emparejados y conseguir una distribución de la carga uniforme.	Bearings specially selected to be used matched for uniform load distribution.
<b>HA1</b>	Aros interior y exterior cementados	Case hardened inner and outer rings
<b>HB1</b>	Aros interior y exterior endurecidos en temple bainítico	Bainite hardened inner and outer rings
<b>CE04</b>	Fosfatados	Phosphate coated
<b>CE09</b>	Rodamientos para aplicaciones de aerogeneración	Bearings for wind energy applications
<b>ENH</b>	Rodamiento perteneciente a la línea $\epsilon^*$ Enhanced, cuyas cargas dinámicas corresponden a los valores de $Cr \epsilon^*$ . (Como referencia se muestran también, en las tablas de producto, los valores de $Cr$ calculados según la norma ISO 281)	$\epsilon^*$ Enhanced bearing series whose dynamic load rating corresponds to $Cr \epsilon^*$ values. (As reference, $Cr$ values calculated according to ISO 281 are shown in the product tables)

Tabla 4. Table 4



### 2.3.1 Rodamientos de una hilera completamente llenos de rodillos cilíndricos Single row full complement cylindrical roller bearings

#### RODAMIENTOS DE APOYO / SEMI-LOCATING BEARINGS

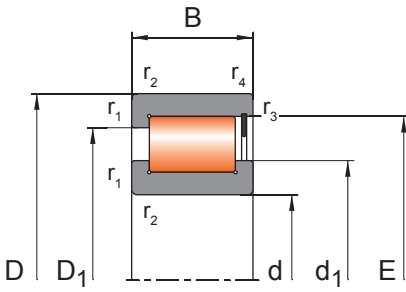

NCF-V

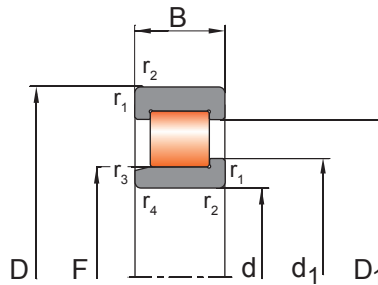

NJ23-VH

DIMENSIONES* BOUNDARY DIMENSIONS*			DESIGNACIÓN DESIGNATION	DESIGNACIÓN ALTERNATIVA ALTERNATIVE DESIGNATION	E*	CAPACIDAD DE CARGA (kN) LOAD RATING (kN)			CARGA LÍM. DE FATIGA / FATIGUE LIMIT LOAD (kN) Cu
d	D	B				dyn. Cr	dyn. E* Cr E*	stat. Cor	
20	42	16	NCF3004-V	SL18-3004	E*	28,8	30	27	4,2
	47	18	NCF2204-V	SL18-2204	E*	43,6	45,5	38	5,8
25	47	16	NCF3005-V	SL18-3005	E*	33,2	35	32	5,2
	52	18	NCF2205-V	SL18-2205	E*	48,6	51	45	7
	62	24	NJ2305-VH	SL19-2305	E*	68,6	72	67	8,9
30	55	19	NCF3006-V	SL18-3006	E*	42,4	44,5	44	7,1
	62	20	NCF2206-V	SL18-2206	E*	66,5	70	62	9,7
	72	27	NJ2306-VH	SL19-2306	E*	93	98	87	13,8
35	62	20	NCF3007-V	SL18-3007	E*	51,8	54	54	8,9
	72	23	NCF2207-V	SL18-2207	E*	83,6	88	80	12,1
	80	31	NJ2307-VH	SL19-2307	E*	117,6	125	113	18,1
40	68	21	NCF3008-V	SL18-3008	E*	62,7	66	68	10,6
	80	23	NCF2208-V	SL18-2208	E*	89,9	95	95	14,2
	90	33	NJ2308-VH	SL19-2308	E*	162,5	170	156	24
45	75	23	NCF3009-V	SL18-3009	E*	64,9	69	74	11,9
	85	23	NCF2209-V	SL18-2209	E*	94,3	100	100	15,2
	100	36	NJ2309-VH	SL19-2309	E*	170	180	174	27,1
50	80	23	NCF3010-V	SL18-3010	E*	82,9	87,5	94	14,3
	90	23	NCF2210-V	SL18-2210	E*	103,7	110	120	17,2
	110	40	NJ2310-VH	SL19-2310	E*	219,4	231	220	36,6
55	90	26	NCF3011-V	SL18-3011	E*	112,6	118	137	21,5
	100	25	NCF2211-V	SL18-2211	E*	133,7	140	155	23,8
	120	43	NJ2311-VH	SL19-2311	E*	257,2	270	259	43,2
60	85	16	NCF2912-V	SL18-2912	E*	58,5	62	79	13
	95	26	NCF3012-V	SL18-3012	E*	116,5	123	144	22,5
	110	28	NCF2212-V	SL18-2212	E*	159,4	167	180	29,5
	130	46	NJ2312-VH	SL19-2312	E*	269,7	285	285	47,5
65	90	16	NCF2913-V	SL18-2913	E*	62,9	66	88	14,8
	100	26	NCF3013-V	SL18-3013	E*	124	130	163	24,7
	120	31	NCF2213-V	SL18-2213	E*	187,1	196	220	35,2
	140	48	NJ2313-VH	SL19-2313	E*	325,7	345	358	59,9
70	100	19	NCF2914-V	SL18-2914	E*	83,8	88	113	17,9

\*Dimensiones en mm. / \* Dimensions in mm.

\*\*Masa en kg. / \*\* Mass in kg.

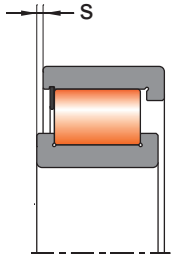

**NCF-V**

**Axial Displacement (s)**

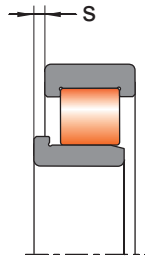

**NJ23-VH**

**Axial Displacement (s)**

DESIGNACIÓN DESIGNATION	VELOCIDADES LÍMITE SPEED RATINGS (rpm)		r <sub>1</sub> , r <sub>2</sub> (min)	r <sub>3</sub> , r <sub>4</sub> (min)	DIMENSIONES SECUNDARIAS SECONDARY DIMENSIONS					MASA** MASS**
	ng aceite ng oil	ng grasa ng grease			E	F	D <sub>1</sub>	d <sub>1</sub>	s	
NCF3004-V	10.200	7.000	0,6	0,6	36,81	-	32,8	28,8	1,5	0,11
NCF2204-V	9.400	6.700	1	1	41,47	-	36,9	30,3	1	0,16
NCF3005-V	8.700	6.300	0,6	0,6	42,51	-	38,5	34,6	1,5	0,12
NCF2205-V	8.200	5.700	1	1	46,52	-	41,9	35,3	1	0,18
NJ2305-VH	7.200	5.300	1,1	1,1	-	31,72	47,5	36,7	2	0,38
NCF3006-V	7.400	5.400	1	1	49,6	-	45,4	40	2	0,2
NCF2206-V	6.900	4.700	1	1	55,19	-	50,6	42	1	0,3
NJ2306-VH	6.200	4.300	1,1	1,1	-	38,3	56	43,5	2	0,56
NCF3007-V	6.500	4.600	1	1	55,52	-	51,3	44,9	2	0,26
NCF2207-V	5.900	4.300	1,1	1,1	63,97	-	59,3	47	1	0,44
NJ2307-VH	5.400	3.800	1,5	1,1	-	44,68	65,8	50,7	2	0,75
NCF3008-V	6.000	4.200	1	1	61,74	-	57,1	50,5	2	0,31
NCF2208-V	5.300	3.900	1,1	1,1	70,94	-	66,3	54	1	0,55
NJ2308-VH	4.900	3.500	1,5	1,5	-	51,12	75,2	57,5	2	1
NCF3009-V	5.300	3.600	1	1	66,85	-	62,2	55,3	2	0,4
NCF2209-V	4.900	3.500	1,1	1,1	74,43	-	69,8	57,5	1	0,59
NJ2309-VH	4.300	3.100	1,5	1,5	-	56,1	80,3	62,5	3	1,4
NCF3010-V	4.900	3.600	1	1	72,33	-	67,7	59,1	2	0,43
NCF2210-V	4.500	3.300	1,1	1,1	81,4	-	76,7	64,4	1	0,64
NJ2310-VH	4.000	2.900	2	2	-	60,72	89,7	68,3	3	1,8
NCF3011-V	4.300	3.100	1,1	1,1	83,54	-	78,8	68,5	2	0,64
NCF2211-V	4.100	3.000	1,5	1,5	88,81	-	84,1	70	1	87
NJ2311-VH	3.600	2.500	2	2	-	67,11	99,3	75,5	3	2,3
NCF2912-V	4.300	3.100	1	1	78,55	-	74,4	69	1	0,29
NCF3012-V	4.100	3.000	1,1	1,1	86,74	-	82,1	71,7	2	0,69
NCF2212-V	3.700	2.500	1,5	1,5	99,17	-	93,9	76,8	1,5	1,2
NJ2312-VH	3.300	2.300	2,1	2,1	-	73,62	105,8	82	3	2,9
NCF2913-V	4.100	3.000	1	1	85,24	-	81	75,7	1	0,31
NCF3013-V	3.800	2.600	1,1	1,1	93,09	-	88,4	78,1	2	0,73
NCF2213-V	3.400	2.300	1,5	1,5	106,25	-	100,7	82,3	1,5	1,6
NJ2313-VH	3.100	2.300	2,1	2,1	-	80,69	116,5	90	3,5	3,6
NCF2914-V	3.700	2.700	1	1	92,31	-	87,8	81,2	1	0,49

\*Dimensiones en mm. / \* Dimensions in mm.

\*\*Masa en kg. / \*\* Mass in kg.



### 2.3.1 Rodamientos de una hilera completamente llenos de rodillos cilíndricos Single row full complement cylindrical roller bearings

#### RODAMIENTOS DE APOYO / SEMI-LOCATING BEARINGS

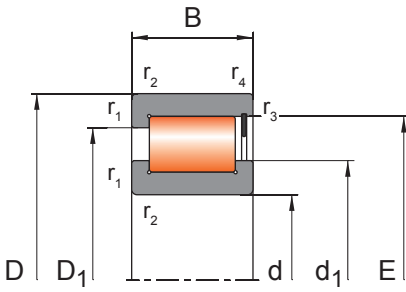

NCF-V

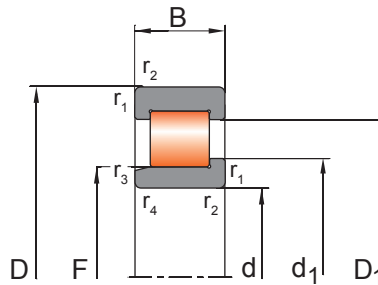

NJ23-VH

DIMENSIONES* BOUNDARY DIMENSIONS*			DESIGNACIÓN DESIGNATION	DESIGNACIÓN ALTERNATIVA ALTERNATIVE DESIGNATION	E*	CAPACIDAD DE CARGA (kN) LOAD RATING (kN)			CARGA LÍM. DE FATIGA / FATIGUE LIMIT LOAD (kN) Cu
d	D	B				dyn. Cr	dyn. E* Cr E*	stat. Cor	
70	110	30	NCF3014-V	SL18-3014	E*	142,4	150	173	28
	125	31	NCF2214-V	SL18-2214	E*	171,2	180	225	30,4
	150	51	NJ2314-VH	SL19-2314	E*	354	375	395	65,6
75	105	19	NCF2915-V	SL18-2915	E*	85,9	90	120	19,1
	115	30	NCF3015-V	SL18-3015	E*	149,8	159	190	30,9
	130	31	NCF2215-V	SL18-2215	E*	176	185	245	31,8
	160	55	NJ2315-VH	SL19-2315	E*	431	450	476	78,9
80	110	19	NCF2916-V	SL18-2916	E*	87,3	92	127	20,3
	125	34	NCF3016-V	SL18-3016	E*	162,1	170	225	29,5
	140	33	NCF2216-V	SL18-2216	E*	212	225	285	36,6
	170	58	NJ2316-VH	SL19-2316	E*	497	525	563	91,2
85	120	22	NCF2917-V	SL18-2917	E*	109,6	115	161	24,2
	130	34	NCF3017-V	SL18-3017	E*	167,8	175	236	30,4
	150	36	NCF2217-V	SL18-2217	E*	238	250	330	42,3
	180	60	NJ2317-VH	SL19-2317	E*	513	545	620	97,9
90	125	22	NCF2918-V	SL18-2918	E*	112,3	118	170	25,2
	140	37	NCF3018-V	SL18-3018	E*	190	200	277	36,1
	160	40	NCF2218-V	SL18-2218	E*	266,7	280	375	48,5
	190	64	NJ2318-VH	SL19-2318	E*	559	585	657	106
95	130	22	NCF2919-V	SL18-2919	E*	122,4	130	185	26,1
	170	43	NCF2219-V	SL18-2219	E*	310	325	430	55,1
	200	67	NJ2319-VH	SL19-2319	E*	601	630	720	114
100	140	24	NCF2920-V	SL18-2920	E*	137	145	202	29,9
	150	37	NCF3020-V	SL18-3020	E*	204	215	307	38,5
	180	46	NCF2220-V	SL18-2220	E*	369	390	530	66,5
	215	73	NJ2320-VH	SL19-2320	E*	725	765	858	136
110	150	24	NCF2922-V	SL18-2922	E*	143	150	216	32,3
	170	45	NCF3022-V	SL18-3022	E*	267	280	386	49,4
	200	53	NCF2222-V	SL18-2222	E*	429	450	580	74,1
	240	80	NJ2322-VH	SL19-2322	E*	891	930	1.050	148
120	165	27	NCF2924-V	SL18-2924	E*	182	190	290	43,2
	180	46	NCF3024-V	SL18-3024	E*	283	295	430	53,2

\*Dimensiones en mm. / \* Dimensions in mm.

\*\*Masa en kg. / \*\* Mass in kg.

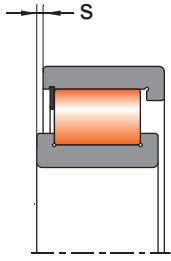

**NCF-V**

Axial Displacement (s)

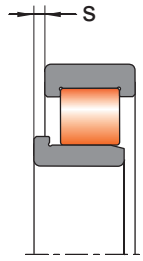

**NJ23-VH**

Axial Displacement (s)

DESIGNACIÓN DESIGNATION	VELOCIDADES LÍMITE SPEED RATINGS (rpm)		r <sub>1</sub> , r <sub>2</sub> (min)	r <sub>3</sub> , r <sub>4</sub> (min)	DIMENSIONES SECUNDARIAS SECONDARY DIMENSIONS					MASA** MASS**
	ng aceite ng oil	ng grasa ng grease			E	F	D <sub>1</sub>	d <sub>1</sub>	s	
NCF3014-V	3.500	2.400	1,1	1,1	100,28	-	95,6	81,5	3	1
NCF2214-V	3.200	2.300	1,5	1,5	111,45	-	105,2	87	1,5	1,7
NJ2314-VH	2.900	2.000	2,1	2,1	-	84,14	121,6	93,5	3,5	4,4
NCF2915-V	3.500	2.500	1	1	97,41	-	92,8	86,3	1	0,52
NCF3015-V	3.300	2.300	1,1	1,1	107,9	-	103,2	89	3	1,1
NCF2215-V	3.100	2.100	1,5	1,5	116,2	-	110	91,8	1,5	1,7
NJ2315-VH	2.700	1.900	2,1	2,1	-	91,22	131,5	101,6	3,5	5,3
NCF2916-V	3.300	2.300	1	1	102,51	-	98	91,4	1	0,55
NCF3016-V	3.100	2.200	1,1	1,1	117,4	-	111,7	95	4	1,4
NCF2216-V	2.900	2.100	2	2	126,3	-	119,3	98,6	1,5	2,2
NJ2316-VH	2.500	1.800	2,1	2,1	-	98,24	142,1	109,5	3,5	6,3
NCF2917-V	3.100	2.200	1,1	1,1	109,58	-	105	96,4	1	0,81
NCF3017-V	2.900	2.100	1,1	1,1	121,95	-	116,1	99,4	4	1,5
NCF2217-V	2.700	2.000	2	2	133,75	-	126,3	104,4	1,5	2,8
NJ2317-VH	2.400	1.700	3	3	-	107,01	150,9	118,2	4	7,4
NCF2918-V	2.900	2.100	1,1	1,1	115,75	-	110,7	102	1	0,84
NCF3018-V	2.700	1.900	1,5	1,5	130,65	-	124,5	106,1	4	2
NCF2218-V	2.500	1.800	2	2	141,15	-	133,3	110,2	2,5	3,5
NJ2318-VH	2.300	1.600	3	3	-	105,26	152,5	117,5	4	8,8
NCF2919-V	2.800	1.900	1,1	1,1	122,25	-	117	106,7	1	0,86
NCF2219-V	2.400	1.800	2,1	2,1	155,95	-	147,3	122	2,5	4,2
NJ2319-VH	2.100	1.500	3	3	-	114,65	161,9	126,6	4	10
NCF2920-V	2.600	1.900	1,1	1,1	130,95	-	125,7	113,4	1,5	1,2
NCF3020-V	2.500	1.700	1,5	1,5	140,2	-	134	115,7	4	2,2
NCF2220-V	2.300	1.600	2,1	2,1	163,35	-	154,3	127,5	2,5	5,1
NJ2320-VH	2.000	1.400	3	3	-	119,3	172,8	132,7	4	13
NCF2922-V	2.400	1.700	1,1	1,1	141,5	-	136,2	124	1,5	1,2
NCF3022-V	2.300	1.600	2	2	156,7	-	149,3	127,3	5,5	3,5
NCF2222-V	2.000	1.400	2,1	2,1	177,6	-	168	137	4	7,3
NJ2322-VH	1.800	1.300	3	3	-	134,27	199,9	151,1	5	17
NCF2924-V	2.200	1.500	1,1	1,1	154,3	-	149	134,8	1,5	1,7
NCF3024-V	2.100	1.400	2	2	168,15	-	160,7	138,8	5,5	3,8

\*Dimensiones en mm. / \* Dimensions in mm.

\*\*Masa en kg. / \*\* Mass in kg.



### 2.3.1 Rodamientos de una hilera completamente llenos de rodillos cilíndricos Single row full complement cylindrical roller bearings

#### RODAMIENTOS DE APOYO / SEMI-LOCATING BEARINGS

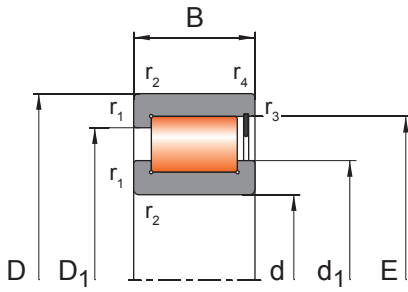

**NCF-V**

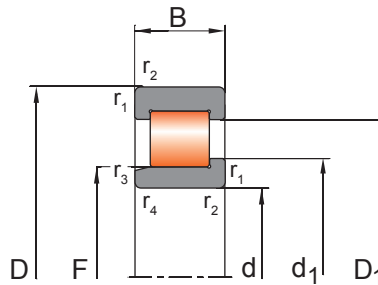

**NJ23-VH**

DIMENSIONES* BOUNDARY DIMENSIONS*			DESIGNACIÓN DESIGNATION	DESIGNACIÓN ALTERNATIVA ALTERNATIVE DESIGNATION	E*	CAPACIDAD DE CARGA (kN) LOAD RATING (kN)			CARGA LÍM. DE FATIGA / FATIGUE LIMIT LOAD (kN) Cu
d	D	B				dyn. Cr	dyn. E* Cr E*	stat. Cor	
120	215	58	NCF2224-V	SL18-2224	E*	503	525	730	90,3
	260	86	NJ2324-VH	SL19-2324	E*	1.020	1.080	1.250	185
130	180	30	NCF2926-V	SL18-2926	E*	225	235	358	51,3
	200	52	NCF3026-V	SL18-3026	E*	397	420	604	75,1
	230	64	NCF2226-V	SL18-2226	E*	580	610	870	105
	280	93	NJ2326-VH	SL19-2326	E*	1.170	1.240	1.410	205
140	190	30	NCF2928-V	SL18-2928	E*	239	250	377	54,2
	210	53	NCF3028-V	SL18-3028	E*	425	450	665	80,8
	250	68	NCF2228-V	SL18-2228	E*	689	720	1.005	121
	300	102	NJ2328-VH	SL19-2328	E*	1.320	1.405	1.575	229
150	190	19	NCF1830-V	SL18-1830	E*	109	115	195	20
	210	36	NCF2930-V	SL18-2930	E*	321	335	489	69,4
	225	56	NCF3030-V	SL18-3030	E*	447	470	708	83,6
	270	73	NCF2230-V	SL18-2230	E*	777	810	1.170	140
	320	108	NJ2330-VH	SL19-2330	E*	1.525	1.610	1.900	252
160	200	20	NCF1832-V	SL18-1832	E*	114	120	210	21
	220	36	NCF2932-V	SL18-2932	E*	329	345	513	73,2
	240	60	NCF3032-V	SL18-3032	E*	512	540	800	94,1
	290	80	NCF2232-V	SL18-2232	E*	980	1.030	1.490	169
	340	114	NJ2332-V	SL19-2332	E*	1.750	1.860	2.200	285
170	215	22	NCF1834-V	SL18-1834	E*	141,5	150	245	25
	230	36	NCF2934-V	SL18-2934	E*	334	350	543	76
	260	67	NCF3034-V	SL18-3034	E*	650	690	1.055	123
	310	86	NCF2234-V	SL18-2234	E*	1.040	1.100	1.680	189
	360	120	NJ2334-VH	SL19-2334	E*	1.915	2.005	2.440	304
180	225	22	NCF1836-V	SL18-1836	E*	153	160	290	28
	250	42	NCF2936-V	SL18-2936	E*	417	435	685	95
	280	74	NCF3036-V	SL18-3036	E*	759	800	1.250	143
	320	86	NCF2236-V	SL18-2236	E*	1.090	1.150	1.775	198
	380	126	NJ2336-V	SL19-2336	E*	2.050	2.200	2.650	340
190	240	24	NCF1838-V	SL18-1838	E*	170	180	320	32
	260	42	NCF2938-V	SL18-2938	E*	457	485	779	106

\*Dimensiones en mm. / \* Dimensions in mm.

\*\*Masa en kg. / \*\* Mass in kg.

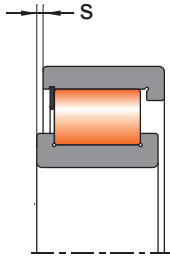

**NCF-V**

Axial Displacement (s)

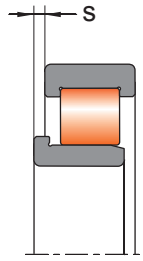

**NJ23-VH**

Axial Displacement (s)

DESIGNACIÓN DESIGNATION	VELOCIDADES LÍMITE SPEED RATINGS (rpm)		r <sub>1</sub> , r <sub>2</sub> (min)	r <sub>3</sub> , r <sub>4</sub> (min)	DIMENSIONES SECUNDARIAS SECONDARY DIMENSIONS					MASA** MASS**
	ng aceite ng oil	ng grasa ng grease			E	F	D <sub>1</sub>	d <sub>1</sub>	s	
NCF2224-V	1.900	1.300	2,1	2,1	192,9	-	183	150,7	4	9,1
NJ2324-VH	1.700	1.200	3	3	-	147,39	213,1	164,2	5	22,4
NCF2926-V	2.000	1.400	1,5	1,5	167,15	-	161,1	146	2	2,3
NCF3026-V	1.900	1.300	2	2	184,4	-	175,5	148,6	5,5	5,7
NCF2226-V	1.800	1.300	3	3	207,75	-	197	162,3	5	11,2
NJ2326-VH	1.400	1.000	4	4	-	157,9	227,9	176	5	28
NCF2928-V	1.900	1.400	1,5	1,5	180	-	174	157	2	2,5
NCF3028-V	1.800	1.300	2	2	198,4	-	189,5	162,2	5,5	6,1
NCF2228-V	1.600	1.100	3	3	222,55	-	211,1	173,9	5	14,5
NJ2328-VH	1.300	900	4	4	-	168,45	243,4	187,8	7	35
NCF1830-V	1.700	1.300	1,2	1,2	179,2	-	175,2	164,2	1,5	1,3
NCF2930-V	1.700	1.300	2	2	196,75	-	189,6	169	2,5	3,8
NCF3030-V	1.600	1.100	2,1	2,1	207,45	-	198	170	7	7,4
NCF2230-V	1.400	1.000	3	3	237,35	-	225,2	185,5	6	18,4
NJ2330-VH	1.200	800	4	4	-	182,49	263,5	203,3	7	42,5
NCF1832-V	1.600	1.100	1,2	1,2	188,8	-	184,8	173,8	1,5	1,5
NCF2932-V	1.600	1.100	2	2	207,6	-	200,5	179,7	2,5	4
NCF3032-V	1.600	1.100	2,1	2,1	225,45	-	215,8	184,8	7	9
NCF2232-V	1.400	1.000	3	3	267,1	-	253,4	208,7	6	23
NJ2332-V	1.200	900	4	4	-	196,38	284,4	219	7	50
NCF1834-V	1.500	1.000	2	2	203,5	-	198,7	185,5	1,5	1,8
NCF2934-V	1.500	1.000	2	2	218,45	-	211,3	190,6	2,5	4,3
NCF3034-V	1.500	1.000	2,1	2,1	243,55	-	232,7	198,1	7	12,5
NCF2234-V	1.300	900	4	4	281,9	-	267,4	220,3	7	28,7
NJ2334-VH	1.100	800	4	4	-	203,55	295	226,6	7	59,5
NCF1836-V	1.500	1.000	2	2	215,2	-	210,4	197,2	2	1,9
NCF2936-V	1.500	1.000	2	2	231,85	-	224	200,7	3	6,2
NCF3036-V	1.300	900	2,1	2,1	261	-	249,4	212,2	7	16,5
NCF2236-V	1.200	900	4	4	294	-	279,5	232,4	7	30
NJ2336-V	1.000	700	4	4	-	221,56	312,9	245	7	69
NCF1838-V	1.400	1.000	2	2	229	-	223,8	209,5	2	2,4
NCF2938-V	1.400	1.000	2	2	244,15	-	238,5	211,5	2	6,5

\*Dimensiones en mm. / \* Dimensions in mm.

\*\*Masa en kg. / \*\* Mass in kg.



### 2.3.1 Rodamientos de una hilera completamente llenos de rodillos cilíndricos Single row full complement cylindrical roller bearings

#### RODAMIENTOS DE APOYO / SEMI-LOCATING BEARINGS

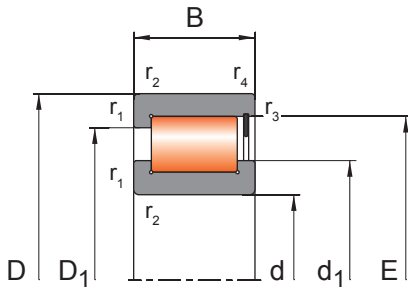

NCF-V

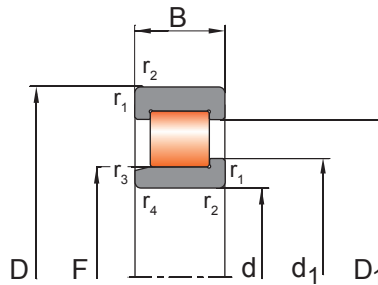

NJ23-VH

DIMENSIONES* BOUNDARY DIMENSIONS*			DESIGNACIÓN DESIGNATION	DESIGNACIÓN ALTERNATIVA ALTERNATIVE DESIGNATION	E*	CAPACIDAD DE CARGA (kN) LOAD RATING (kN)			CARGA LÍM. DE FATIGA / FATIGUE LIMIT LOAD (kN) Cu
d	D	B				dyn. Cr	dyn. E* Cr E*	stat. Cor	
190	290	75	NCF3038-V	SL18-3038	E*	765	810	1.290	147
	340	92	NCF2238-V	SL18-2238	E*	1.210	1.280	1.900	212
	400	132	NJ2338-VH	SL19-2338	E*	2.290	2.415	2.995	370
200	250	24	NCF1840-V	SL18-1840	E*	169	177	325	31,8
	280	48	NCF2940-V	SL18-2940	E*	569	595	965	128
	310	82	NCF3040-V	SL18-3040	E*	900	940	1.510	169
	360	98	NCF2240-V	SL18-2240	E*	1.330	1.410	2.050	223
	420	138	NJ2340-VH	SL19-2340	E*	2.660	2.770	3.250	399
220	270	24	NCF1844-V	SL18-1844	E*	177	185	365	34,2
	300	48	NCF2944-V	SL18-2944	E*	622	650	1.040	137
	340	90	NCF3044-V	SL18-3044	E*	1.080	1.130	1.800	199
	460	145	NJ2344-VH	SL19-2344	E*	1.740	2.855	3.480	404
240	300	28	NCF1848-V	SL18-1848	E*	252	265	504	48,5
	320	48	NCF2948-V	SL18-2948	E*	559	590	1.140	118
	360	92	NCF3048-V	SL18-3048	E*	1.130	1.200	1.965	213
260	320	28	NCF1852-V	SL18-1852	E*	257	270	546	51,3
	360	60	NCF2952-V	SL18-2952	E*	736	770	1.435	152
	400	104	NCF3052-V	SL18-3052	E*	1.515	1.600	2.545	266
280	350	33	NCF1856-V	SL18-1856	E*	332	350	676	65,6
	380	60	NCF2956-V	SL18-2956	E*	851	900	1.725	175
	420	106	NCF3056-V	SL18-3056	E*	1.565	1.630	2.650	275
300	380	38	NCF1860-V	SL18-1860	E*	430	455	850	81,7
	420	72	NCF2960-V	SL18-2960	E*	1.080	1.150	2.200	220
	460	118	NCF3060-V	SL18-3060	E*	1.890	2.000	3.280	309
320	400	38	NCF1864-V	SL18-1864	E*	438	460	900	85,5
	440	72	NCF2964-V	SL18-2964	E*	1.140	1.200	1.360	234
	480	121	NCF3064-V	SL18-3064	E*	1.950	2.050	3.450	323
340	420	38	NCF1868-V	SL18-1868	E*	456	480	960	89,3
	460	72	NCF2968-V	SL18-2968	E*	1.195	1.250	2.490	242
	520	133	NCF3068-V	SL18-3068	E*	2.310	2.450	4.150	380
360	440	38	NCF1872-V	SL18-1872	E*	458	480	966	93
	480	72	NCF2972-V	SL18-2972	E*	1.195	1.260	2.600	252

\*Dimensiones en mm. / \* Dimensions in mm.

\*\*Masa en kg. / \*\* Mass in kg.



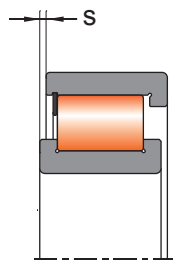

**NCF-V**

**Axial Displacement (s)**

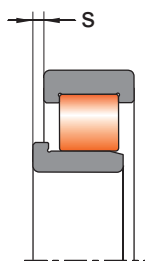

**NJ23-VH**

**Axial Displacement (s)**

DESIGNACIÓN DESIGNATION	VELOCIDADES LÍMITE SPEED RATINGS (rpm)		r <sub>1</sub> , r <sub>2</sub> (min)	r <sub>3</sub> , r <sub>4</sub> (min)	DIMENSIONES SECUNDARIAS SECONDARY DIMENSIONS					MASA** MASS**
	ng aceite ng oil	ng grasa ng grease			E	F	D <sub>1</sub>	d <sub>1</sub>	s	
NCF3038-V	1.300	900	2,1	2,1	270,6	-	259	221,8	9	17
NCF2238-V	1.100	800	4	4	311,5	-	295,5	243,5	9	35,7
NJ2338-VH	900	600	5	5	-	224,43	326,8	250	7	80
NCF1840-V	1.400	1.000	1,5	1,5	237,6	-	231,6	216,6	2	2,6
NCF2940-V	1.300	900	2,1	2,1	261,6	-	252,4	225,5	3	9,1
NCF3040-V	1.200	900	2,1	2,1	288,6	-	276,2	236,6	9	22
NCF2240-V	1.100	800	4	4	319,4	-	302,4	246,6	9	43
NJ2340-VH	900	700	5	5	-	238,45	347,2	265,7	7	92
NCF1844-V	1.200	900	1,5	1,5	258,5	-	252,3	237,3	2	2,8
NCF2944-V	1.200	900	2,1	2,1	282,45	-	273,2	246,3	3	9,9
NCF3044-V	1.100	800	3	3	312	-	299,2	254,6	9	29
NJ2344-VH	800	600	5	5	-	266,71	388,3	297	7	111
NCF1848-V	1.100	800	2	2	287,5	-	281	260,5	2	4,3
NCF2948-V	1.100	800	2,1	2,1	303,7	-	294,4	267,5	3	10,6
NCF3048-V	1.000	700	3	3	336	-	322,1	277,5	11	31
NCF1852-V	1.000	700	2	2	308	-	301,5	281	2	4,7
NCF2952-V	1.000	700	2,1	2,1	333,7	-	323,4	291,5	5	18,5
NCF3052-V	1.000	700	4	4	375,97	-	358,4	304	11	45
NCF1856-V	1.000	700	2	2	335	-	327	304	2,5	7
NCF2956-V	900	600	2,1	2,1	359,5	-	348,5	314	3,5	20
NCF3056-V	900	600	4	4	390,3	-	372,9	319,5	11	49
NCF1860-V	900	600	2,1	2,1	360	-	350,5	323,5	3	10
NCF2960-V	900	600	3	3	389,45	-	376,9	338	5	31,5
NCF3060-V	800	500	4	4	434,85	-	415,6	353,6	14	68
NCF1864-V	900	600	2,1	2,1	381	-	371,5	344,5	3	10,5
NCF2964-V	800	600	3	3	409,85	-	397,4	358,5	5	33
NCF3064-V	700	500	4	4	449,5	-	430,1	369,5	14	73
NCF1868-V	800	600	2,1	2,1	402,2	-	392,5	365,5	3	11
NCF2968-V	700	500	3	3	430,2	-	418,7	379	5	35
NCF3068-V	700	500	5	5	485,65	-	463,9	396,1	16	97
NCF1872-V	700	500	2,1	2,1	423,5	-	413,5	387	3	11,5
NCF2972-V	700	500	3	3	450,6	-	438,6	399,5	5	36,5

\*Dimensiones en mm. / \* Dimensions in mm.

\*\*Masa en kg. / \*\* Mass in kg.



### 2.3.1 Rodamientos de una hilera completamente llenos de rodillos cilíndricos Single row full complement cylindrical roller bearings

#### RODAMIENTOS DE APOYO / SEMI-LOCATING BEARINGS

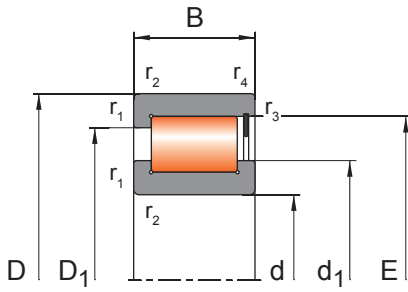

NCF-V

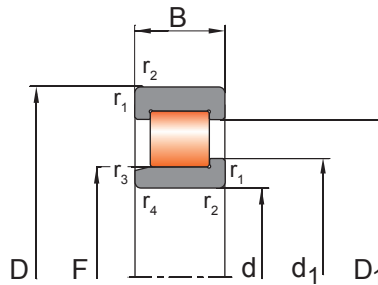

NJ23-VH

DIMENSIONES* BOUNDARY DIMENSIONS*			DESIGNACIÓN DESIGNATION	DESIGNACIÓN ALTERNATIVA ALTERNATIVE DESIGNATION	E*	CAPACIDAD DE CARGA (kN) LOAD RATING (kN)			CARGA LÍM. DE FATIGA / FATIGUE LIMIT LOAD (kN) Cu
d	D	B				dyn. Cr	dyn. E* Cr E*	stat. Cor	
360	540	134	NCF3072-V	SL18-3072	E*	2.360	2.500	4.300	420
380	480	46	NCF1876-V	SL18-1876	E*	603	640	1.290	120
	520	82	NCF2976-V	SL18-2976	E*	1.535	1.600	3.250	320
	560	135	NCF3076-V	SL18-3076	E*	2.430	2.550	4.470	420
400	500	46	NCF1880-V	SL18-1880	E*	619	650	1.340	120
	540	82	NCF2980-V	SL18-2980	E*	1.615	1.700	3.470	335
	600	148	NCF3080-V	SL18-3080	E*	2.910	3.040	5.440	475
420	520	46	NCF1884-V	SL18-1884	E*	647	680	1.430	125
	560	82	NCF2984-V	SL18-2984	E*	1.620	1.700	3.600	337
440	540	46	NCF1888-V	SL18-1888	E*	668	700	1.460	132
	600	95	NCF2988-V	SL18-2988	E*	1.960	2.080	4.250	385
460	580	56	NCF1892-V	SL18-1892	E*	893	940	1.910	170
	620	95	NCF2992-V	SL18-2992	E*	2.010	2.100	4.340	390
480	600	56	NCF1896-V	SL18-1896	E*	904	950	2.010	176
	650	100	NCF2996-V	SL18-2996	E*	2.240	2.350	4.800	437
500	620	56	NCF18/500-V	SL18-18/500	E*	924	970	2.055	180
	670	100	NCF29/500-V	SL18-29/500	E*	2.260	2.400	4.990	446
530	650	56	NCF18/530-V	SL18-18/530	E*	990	1.080	2.250	185
	710	106	NCF29/530-V	SL18-29/530	E*	2.650	2.850	6.200	510
560	680	56	NCF18/560-V	SL18-18/560	E*	1.000	1.100	2.400	195
	750	112	NCF29/560-V	SL18-29/560	E*	3.055	3.200	6.750	505
600	730	60	NCF18/600-V	SL18-18/600	E*	1.050	1.150	2.500	200
	800	118	NCF29/600-V	SL18-29/600	E*	3.150	3.300	7.200	540
630	780	69	NCF18/630-V	SL18-18/630	E*	1.200	1.320	3.000	245
	850	128	NCF29/630-V	SL18-29/630	E*	3.750	3.900	8.670	615
670	820	69	NCF18/670-V	SL18-18/670	E*	1.300	1.390	3.200	255
710	870	74	NCF18/710-V	SL18-18/710	E*	1.500	1.610	3.750	295
750	920	78	NCF18/750-V	SL18-18/750	E*	1.770	1.890	4.330	325

\*Dimensiones en mm. / \* Dimensions in mm.

\*\*Masa en kg. / \*\* Mass in kg.

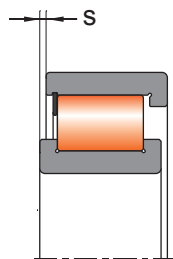

**NCF-V**

Axial Displacement (s)

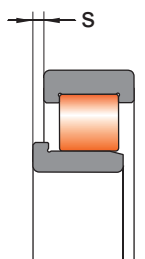

**NJ23-VH**

Axial Displacement (s)

DESIGNACIÓN DESIGNATION	VELOCIDADES LÍMITE SPEED RATINGS (rpm)		r <sub>1</sub> , r <sub>2</sub> (min)	r <sub>3</sub> , r <sub>4</sub> (min)	DIMENSIONES SECUNDARIAS SECONDARY DIMENSIONS					MASA** MASS**
	ng aceite ng oil	ng grasa ng grease			E	F	D <sub>1</sub>	d <sub>1</sub>	s	
NCF3072-V	700	500	5	5	503,45	-	481,6	414	16	104
NCF1876-V	700	500	2,1	2,1	459	-	448	415,5	4	19
NCF2976-V	700	500	4	4	486,7	-	472,1	426	5	52,5
NCF3076-V	700	500	5	5	521,25	-	499,5	431,7	16	109
NCF1880-V	700	500	2,1	2,1	475,5	-	464,5	432	4	20
NCF2980-V	600	400	4	4	510,85	-	496,1	450	5	54,5
NCF3080-V	600	400	5	5	558,52	-	535,1	462,5	18	145
NCF1884-V	600	400	2,1	2,1	500	-	489,5	457	4	21
NCF2984-V	600	400	4	4	522,95	-	509	462	5	57
NCF1888-V	600	400	2,1	2,1	517	-	506	473,5	4	22
NCF2988-V	600	400	4	4	562	-	544,6	490	7	80
NCF1892-V	600	400	3	3	554	-	541	501,5	5	33,5
NCF2992-V	600	400	4	4	576,3	-	559,6	504	7	82
NCF1896-V	600	400	3	3	474,5	-	561	522	5	35
NCF2996-V	500	400	5	5	614,75	-	596,6	538	7	97
NCF18/500-V	500	400	3	3	594,5	-	581,5	542	5	36
NCF29/500-V	500	400	5	5	630	-	612,7	553	7	99
NCF18/530-V	400	300	3	3	624,2	-	611,4	576,2	5	38,5
NCF29/530-V	400	300	5	5	672,8	-	652,8	597,8	7	120
NCF18/560-V	400	300	3	3	654,7	-	641,9	606,7	5	40,5
NCF29/560-V	400	300	5	5	709,4	-	687,8	628,4	7	140
NCF18/600-V	400	300	3	3	695,5	-	682,7	647,5	7	51
NCF29/600-V	300	200	5	5	753,5	-	731,1	669,5	7	170
NCF18/630-V	300	200	4	4	736,6	-	722,2	682,6	8	73
NCF29/630-V	300	200	6	6	807,2	-	783,2	717,2	8	210
NCF18/670-V	300	200	4	4	782,4	-	768	728,4	8	76,5
NCF18/710-V	300	200	4	4	831,1	-	815,1	771,1	8	93
NCF18/750-V	250	200	5	5	879,8	-	862,6	815,3	8	110

\*Dimensiones en mm. / \*Dimensions in mm.

\*\*Masa en kg. / \*\*Mass in kg.



### 2.3.2 Rodamientos de doble hilera completamente llenos de rodillos cilíndricos Double row full complement cylindrical roller bearings

## RODAMIENTOS LIBRES, DE APOYO, FIJOS / NON-LOCATING, SEMI-LOCATING, LOCATING BEARINGS

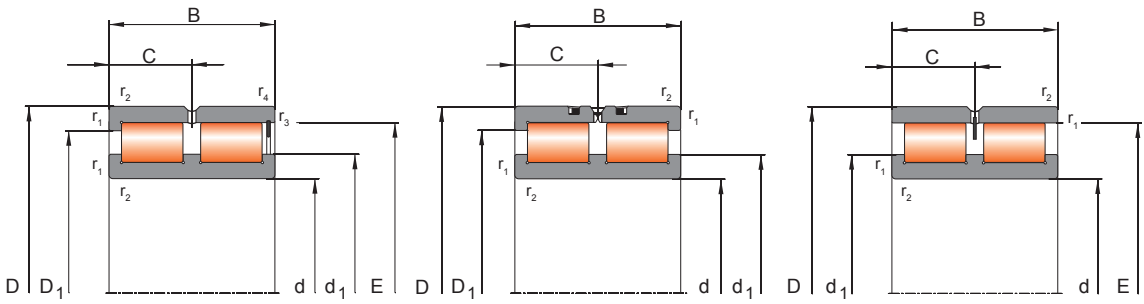

**NCF50-V**

**NCC-V**

**NNCL-V**

DIMENSIONES* BOUNDARY DIMENSIONS*			DESIGNACION DESIGNATION	DESIGNACION ALTERNATIVA ALTERNATIVE DESIGNATION	E*	CAPACIDAD DE CARGA (kN) LOAD RATING (kN)			CARGA LIM. DE FATIGA / FATIGUE LIMIT LOAD (kN) Cu
d	D	B				dyn. Cr	dyn. E* Cr E*	stat. Cor	
20	42	30	NCF5004-V	SL18-5004	E*	51	53	55	8,5
25	47	30	NCF5005-V	SL18-5005	E*	57	60	68	10,5
30	55	34	NCF5006-V	SL18-5006	E*	72	77	86	14,3
35	62	36	NCF5007-V	SL18-5007	E*	89	94	112	17,5
40	68	38	NCF5008-V	SL18-5008	E*	106	112	139	21,3
45	75	40	NCF5009-V	SL18-5009	E*	114	120	155	23,7
50	80	40	NCF5010-V	SL18-5010	E*	143	150	195	28,5
55	90	46	NCF5011-V	SL18-5011	E*	189	200	280	42,8
60	85	25	NCC4912-V	SL01-4912	E*	72	76	130	16,4
	85	25	NNCL4912-V	SL02-4912	E*	72	76	130	16,4
	95	46	NCF5012-V	SL18-5012	E*	198	210	295	45,1
65	100	46	NCF5013-V	SL18-5013	E*	208	220	320	49,4
70	100	30	NCC4914-V	SL01-4914	E*	105	110	190	25,7
	100	30	NNCL4914-V	SL02-4914	E*	105	110	190	25,7
	110	54	NCF5014-V	SL18-5014	E*	249	260	350	45
75	115	54	NCF5015-V	SL18-5015	E*	254	270	380	49
80	110	30	NCC4916-V	SL01-4916	E*	115	120	210	28,5
	110	30	NNCL4916-V	SL02-4916	E*	115	120	210	28,5
	125	60	NCF5016-V	SL18-5016	E*	288	305	450	58,9
85	130	60	NCF5017-V	SL18-5017	E*	294	310	470	60,8
90	125	35	NCC4918-V	SL01-4918	E*	151	160	300	37,1
	125	35	NNCL4918-V	SL02-4918	E*	151	160	300	37,1
	140	67	NCF5018-V	SL18-5018	E*	339	360	550	69,5
100	140	40	NCC4920-V	SL01-4920	E*	193	205	380	47
	140	40	NNCL4920-V	SL02-4920	E*	193	205	380	47
	150	67	NCF5020-V	SL18-5020	E*	370	390	610	77
110	150	40	NCC4922-V	SL01-4922	E*	202	210	430	49
	150	40	NNCL4922-V	SL02-4922	E*	202	210	430	49
	170	80	NCF5022-V	SL18-5022	E*	476	500	780	98,8
120	165	45	NCC4924-V	SL01-4924	E*	225	235	475	53
	165	45	NNCL4924-V	SL02-4924	E*	225	235	475	53
	180	80	NCF5024-V	SL18-5024	E*	510	535	880	106

\*Dimensiones en mm. / \* Dimensions in mm.

\*\*Masa en kg. / \*\* Mass in kg.

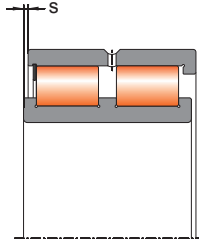

**NNCF50-V**  
Axial Displacement (s)

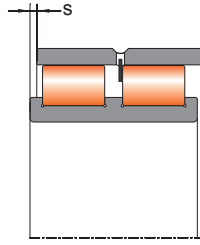

**NNCL-V**  
Axial Displacement (s)

DESIGNACION DESIGNATION	VELOCIDADES LIMITE SPEED RATINGS (rpm)		r <sub>1</sub> , r <sub>2</sub> (min)	r <sub>3</sub> , r <sub>4</sub> (min)	DIMENSIONES SECUNDARIAS SECONDARY DIMENSIONS					MASA** MASS**
	ng aceite ng oil	ng grasa ng grease			E	C	D <sub>1</sub>	d <sub>1</sub>	s	
NNCF5004-V	10.400	7.700	0,6	0,6	36,81	15	33,3	28,4	1	0,2
NNCF5005-V	8.900	6.600	0,6	0,6	42,51	15	39	34,5	1	0,23
NNCF5006-V	7.600	5.600	1	1	49,6	17	45,3	40	1,5	0,35
NNCF5007-V	6.700	4.900	1	1	55,52	18	51,2	44,9	1,5	0,46
NNCF5008-V	6.000	4.500	1	1	61,74	19	57,2	50,5	1,5	0,56
NNCF5009-V	5.500	4.100	1	1	66,85	20	62,6	55,3	1,5	0,71
NNCF5010-V	5.100	3.700	1	1	72,33	20	67,6	59,1	1,5	0,76
NNCF5011-V	4.400	3.200	1,1	1,1	83,54	23	78,7	68,5	1,5	1,16
NNC4912-V	4.500	3.400	1	-	-	12,5	73,5	70,3	-	0,49
NNCL4912-V	4.500	3.400	1	-	77,51	12,5	-	70,3	1	0,47
NNCF5012-V	4.000	2.900	1,1	1,1	86,74	23	81,9	71,7	1,5	1,24
NNCF5013-V	3.800	2.800	1,1	1,1	93,09	23	88,3	78,1	1,5	1,3
NNC4914-V	3.800	2.800	1	-	-	15	87,4	82,5	-	0,78
NNCL4914-V	3.800	2.800	1	-	91,87	15	-	82,5	1	0,75
NNCF5014-V	3.600	2.600	1,1	1,1	100,28	27	95,7	81,5	3	1,85
NNCF5015-V	3.300	2.400	1,1	1,1	107,9	27	102,9	89	3	1,93
NNC4916-V	3.400	2.500	1	-	-	15	96,2	91,4	-	0,88
NNCL4916-V	3.400	2.500	1	-	100,78	15	-	91,4	1	0,85
NNCF5016-V	3.100	2.300	1,1	1,1	117,4	30	111,7	95	3,5	2,6
NNCF5017-V	3.000	2.200	1,1	1,1	121,95	30	116,1	99	3,5	2,72
NNC4918-V	3.000	2.200	1,1	-	-	17,5	110,7	103,9	-	1,35
NNCL4918-V	3.000	2.200	1,1	-	115,2	17,5	-	103	1,5	1,3
NNCF5018-V	2.800	2.000	1,5	1,5	130,65	33,5	124,5	106,1	4	3,6
NNC4920-V	2.700	2.000	1,1	-	-	20	125	116,4	-	1,95
NNCL4920-V	2.700	2.000	1,1	-	129,6	20	-	116,4	2	1,9
NNCF5020-V	2.600	1.900	1,5	1,5	140,2	33,5	134	115,7	4	3,94
NNC4922-V	2.400	1.800	1,1	-	-	20	133,6	125	-	2,15
NNCL4922-V	2.400	1.800	1,1	-	138,2	20	-	125	2	2,1
NNCF5022-V	2.200	1.600	2	2	156,7	40	149,3	127,3	5	6,3
NNC4924-V	2.200	1.600	1,1	-	-	22,5	148,6	138,6	-	3
NNCL4924-V	2.200	1.600	1,1	-	153,55	22,5	-	138,6	3	2,85
NNCF5024-V	2.100	1.500	2	2	168,15	40	160,7	138,8	5	6,77

\*Dimensiones en mm. / \* Dimensions in mm.

\*\*Masa en kg. / \*\* Mass in kg.



### 2.3.2 Rodamientos de doble hilera completamente llenos de rodillos cilíndricos Double row full complement cylindrical roller bearings

## RODAMIENTOS LIBRES, DE APOYO, FIJOS / NON-LOCATING, SEMI-LOCATING, LOCATING BEARINGS

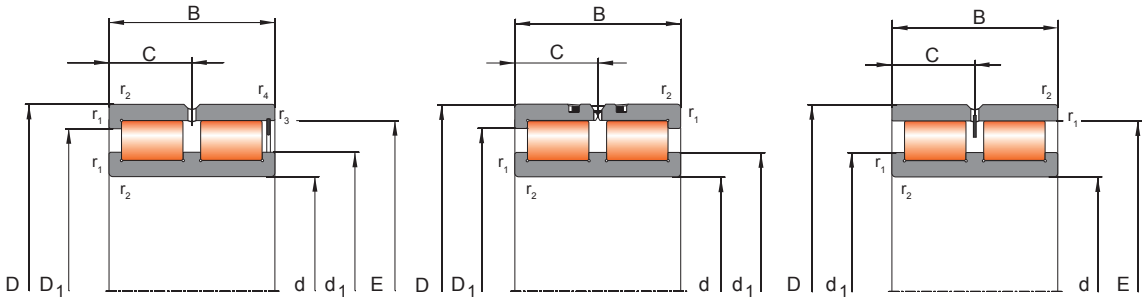

**NCF50-V**

**NNC-V**

**NNCL-V**

DIMENSIONES* BOUNDARY DIMENSIONS*			DESIGNACION DESIGNATION	DESIGNACION ALTERNATIVA ALTERNATIVE DESIGNATION	E*	CAPACIDAD DE CARGA (kN) LOAD RATING (kN)			CARGA LIM. DE FATIGA / FATIGUE LIMIT LOAD (kN) Cu
d	D	B				dyn. Cr	dyn. E* Cr E*	stat. Cor	
130	180	50	NNC4926-V	SL01-4926	E*	259	275	520	60
	180	50	NNCL4926-V	SL02-4926	E*	259	275	520	60
	200	95	NCF5026-V	SL18-5026	E*	727	760	1.240	150
140	190	50	NNC4928-V	SL01-4928	E*	270	285	555	65
	190	50	NNCL4928-V	SL02-4928	E*	270	285	555	65
	210	95	NCF5028-V	SL18-5028	E*	756	800	1.370	160
150	190	40	NNC4830-V	SL01-4830	E*	228	240	570	61
	190	40	NNCL4830-V	SL02-4830	E*	228	240	570	61
	210	60	NNC4930-V	SL01-4930	E*	405	420	820	93,1
	210	60	NNCL4930-V	SL02-4930	E*	405	420	820	93,1
	225	100	NCF5030-V	SL18-5030	E*	792	830	1.430	166
160	200	40	NNC4832-V	SL01-4832	E*	236	250	600	63
	200	40	NNCL4832-V	SL02-4832	E*	236	250	600	63
	220	60	NNC4932-V	SL01-4932	E*	420	440	900	98,8
	220	60	NNCL4932-V	SL02-4932	E*	420	440	900	98,8
	240	109	NCF5032-V	SL18-5032	E*	886	940	1.600	189
170	215	45	NNC4834-V	SL01-4834	E*	260	275	645	67
	215	45	NNCL4834-V	SL02-4834	E*	260	275	645	67
	230	60	NNC4934-V	SL01-4934	E*	425	450	935	103
	230	60	NNCL4934-V	SL02-4934	E*	425	450	935	103
	260	122	NCF5034-V	SL18-5034	E*	1.155	1.215	2.120	247
180	225	45	NNC4836-V	SL01-4836	E*	263	280	690	71
	225	45	NNCL4836-V	SL02-4836	E*	263	280	690	71
	250	69	NNC4936-V	SL01-4936	E*	565	590	1.200	133
	250	69	NNCL4936-V	SL02-4936	E*	565	590	1.200	133
	280	136	NCF5036-V	SL18-5036	E*	1.340	1.410	2.500	280
190	240	50	NNC4838-V	SL01-4838	E*	310	325	740	77
	240	50	NNCL4838-V	SL02-4838	E*	310	325	740	77
	260	69	NNC4938-V	SL01-4938	E*	574	600	1.280	138
	260	69	NNCL4938-V	SL02-4938	E*	574	600	1.280	138
	290	136	NCF5038-V	SL18-5038	E*	1.380	1.460	2.600	300
200	250	50	NNC4840-V	SL01-4840	E*	314	330	800	82

\*Dimensiones en mm. / \* Dimensions in mm.

\*\*Masa en kg. / \*\* Mass in kg.

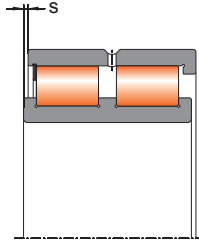

**NNCF50-V**  
Axial Displacement (s)

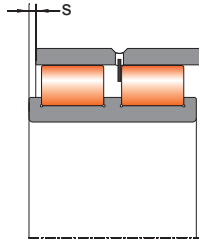

**NNCL-V**  
Axial Displacement (s)

DESIGNACION DESIGNATION	VELOCIDADES LIMITE SPEED RATINGS (rpm)		r <sub>1</sub> , r <sub>2</sub> (min)	r <sub>3</sub> , r <sub>4</sub> (min)	DIMENSIONES SECUNDARIAS SECONDARY DIMENSIONS					MASA** MASS**
	ng aceite ng oil	ng grasa ng grease			E	C	D <sub>1</sub>	d <sub>1</sub>	s	
NNC4926-V	2.000	1.500	1,5	-	-	25	160	148,4	-	4
NNCL4926-V	2.000	1.500	1,5	-	165,4	25	-	149,5	4	3,8
NNCF5026-V	1.900	1.400	2	2	184,4	47,5	175,5	148,6	5	10,2
NNC4928-V	1.900	1.400	1,5	-	-	25	170,5	159	-	4,2
NNCL4928-V	1.900	1.400	1,5	-	175,9	25	-	160	4	4,1
NNCF5028-V	1.800	1.300	2	2	198,4	47,5	189,5	162,6	5	11,1
NNC4830-V	1.900	1.400	1,1	-	-	20	174,2	165,1	-	2,9
NNCL4830-V	1.900	1.400	1,1	-	178,3	20	-	165,1	2	2,73
NNC4930-V	1.800	1.300	2	-	-	30	187,2	171,8	-	6,65
NNCL4930-V	1.800	1.300	2	-	192,77	30	-	171,8	4	6,45
NNCF5030-V	1.700	1.200	2	2	207,45	50	198	170	6	13,3
NNC4832-V	1.800	1.300	1,1	-	-	20	182,8	173,7	-	3,1
NNCL4832-V	1.800	1.300	1,1	-	186,9	20	-	173,7	2	3
NNC4932-V	1.700	1.200	2	-	-	30	200,3	184,2	-	7
NNCL4932-V	1.700	1.200	2	-	206,16	30	-	184,2	4	6,8
NNCF5032-V	1.600	1.200	2,1	2,1	224,8	54,5	215,8	184,8	6	16
NNC4834-V	1.600	1.200	1,1	-	-	22,5	197	186,3	-	4,1
NNCL4834-V	1.600	1.200	1,1	-	201,3	22,5	-	186,3	3	3,92
NNC4934-V	1.600	1.200	2	-	-	30	209,1	193,1	-	7,35
NNCL4934-V	1.600	1.200	2	-	215,08	30	-	193,1	4	7,1
NNCF5034-V	1.400	1.000	2,1	2,1	242,85	61	232,7	198	6	23
NNC4836-V	1.600	1.200	1,1	-	-	22,5	209,8	199,1	-	4,3
NNCL4836-V	1.600	1.200	1,1	-	214,1	22,5	-	199,1	3	4,1
NNC4936-V	1.500	1.100	2	-	-	34,5	224,1	204,9	-	10,8
NNCL4936-V	1.500	1.100	2	-	230,5	34,5	-	204,9	4	10,5
NNCF5036-V	1.300	900	2,1	2,1	260,22	68	249,4	212,2	8	30
NNC4838-V	1.500	1.100	1,5	-	-	25	220,7	207,6	-	5,7
NNCL4838-V	1.500	1.100	1,5	-	225	25	-	207,6	4	5,4
NNC4938-V	1.400	1.000	2	-	-	34,5	234,3	215	-	11,2
NNCL4938-V	1.400	1.000	2	-	240,7	34,5	-	215	4	10,9
NNCF5038-V	1.300	900	2,1	2,1	269,76	68	259	221,8	8	31,5
NNC4840-V	1.400	1.000	1,5	-	-	25	231,2	218,1	-	5,9

\*Dimensiones en mm. / \* Dimensions in mm.

\*\*Masa en kg. / \*\* Mass in kg.



### 2.3.2 Rodamientos de doble hilera completamente llenos de rodillos cilíndricos Double row full complement cylindrical roller bearings

#### RODAMIENTOS LIBRES, DE APOYO, FIJOS / NON-LOCATING, SEMI-LOCATING, LOCATING BEARINGS

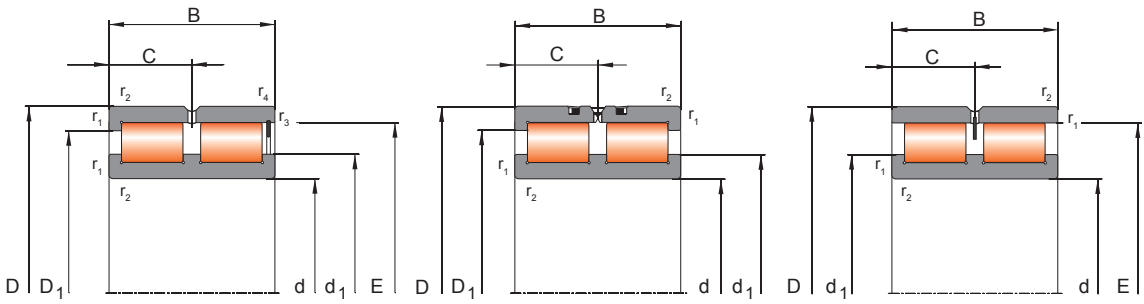

**NNCF50-V**

**NNC-V**

**NNCL-V**

DIMENSIONES* BOUNDARY DIMENSIONS*			DESIGNACION DESIGNATION	DESIGNACION ALTERNATIVA ALTERNATIVE DESIGNATION	E*	CAPACIDAD DE CARGA (kN) LOAD RATING (kN)			CARGA LIM. DE FATIGA / FATIGUE LIMIT LOAD (kN) Cu
d	D	B				dyn. Cr	dyn. E* Cr E*	stat. Cor	
200	250	50	NNCL4840-V	SL02-4840	E*	314	330	800	82
	280	80	NNC4940-V	SL01-4940	E*	658	690	1.500	157
	280	80	NNCL4940-V	SL02-4940	E*	658	690	1.500	157
	310	150	NNCF5040-V	SL18-5040	E*	1.550	1.660	3.000	340
220	270	50	NNC4844-V	SL01-4844	E*	330	350	850	85,5
	270	50	NNCL4844-V	SL02-4844	E*	330	350	850	85,5
	300	80	NNC4944-V	SL01-4944	E*	690	725	1.550	165
	300	80	NNCL4944-V	SL02-4944	E*	690	725	1.550	165
	340	160	NNCF5044-V	SL18-5044	E*	1.900	2.000	3.650	400
240	300	60	NNC4848-V	SL01-4848	E*	510	535	1.280	128
	300	60	NNCL4848-V	SL02-4848	E*	510	535	1.280	128
	320	80	NNC4948-V	SL01-4948	E*	736	770	1.750	177
	320	80	NNCL4948-V	SL02-4948	E*	736	770	1.750	177
	360	160	NNCF5048-V	SL18-5048	E*	1.960	2.100	4.000	420
260	320	60	NNC4852-V	SL01-4852	E*	526	550	1.380	136
	320	60	NNCL4852-V	SL02-4852	E*	526	550	1.380	136
	360	100	NNC4952-V	SL01-4952	E*	1.100	1.165	2.535	256
	360	100	NNCL4952-V	SL02-4952	E*	1.100	1.165	2.535	256
	400	190	NNCF5052-V	SL18-5052	E*	2.700	2.820	5.000	530
280	350	69	NNC4856-V	SL01-4856	E*	702	735	1.850	180
	350	69	NNCL4856-V	SL02-4856	E*	702	735	1.850	180
	380	100	NNC4956-V	SL01-4956	E*	1.155	1.210	2.700	271
	380	100	NNCL4956-V	SL02-4956	E*	1.155	1.210	2.700	271
	420	190	NNCF5056-V	SL18-5056	E*	2.800	2.900	5.300	550
300	380	80	NNC4860-V	SL01-4860	E*	810	845	2.100	203
	380	80	NNCL4860-V	SL02-4860	E*	810	845	2.100	203
	420	118	NNC4960-V	SL01-4960	E*	1.600	1.680	3.700	370
	420	118	NNCL4960-V	SL02-4960	E*	1.600	1.680	3.700	370
	460	218	NNCF5060-V	SL18-5060	E*	3.300	3.500	6.600	620
320	400	80	NNC4864-V	SL01-4864	E*	840	880	2.250	214
	400	80	NNCL4864-V	SL02-4864	E*	840	880	2.250	214
	440	118	NNC4964-V	SL01-4964	E*	1.655	1.740	4.000	395

\*Dimensiones en mm. / \* Dimensions in mm.

\*\*Masa en kg. / \*\* Mass in kg.



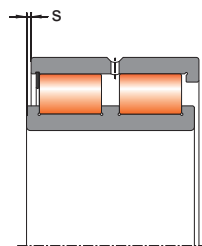

**NNCF50-V**  
Axial Displacement (s)

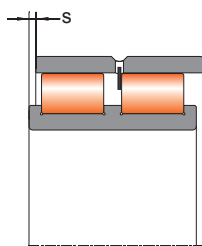

**NNCL-V**  
Axial Displacement (s)

DESIGNACION DESIGNATION	VELOCIDADES LIMITE SPEED RATINGS (rpm)		r <sub>1</sub> , r <sub>2</sub> (min)	r <sub>3</sub> , r <sub>4</sub> (min)	DIMENSIONES SECUNDARIAS SECONDARY DIMENSIONS					MASA** MASS**
	ng aceite ng oil	ng grasa ng grease			E	C	D <sub>1</sub>	d <sub>1</sub>	s	
NNCL4840-V	1.400	1.000	1,5	-	235,5	25	-	218.1	4	5,7
NNC4940-V	1.300	1.000	2,1	-	-	40	252,3	230,5	-	15,8
NNCL4940-V	1.300	1.000	2,1	-	259,34	40	-	230,5	5	15,3
NNCF5040-V	1.200	900	2,1	2,1	287,75	75	276,2	236,6	9	41
NNC4844-V	1.300	900	1,5	-	-	25	252,3	239,1	-	6,4
NNCL4844-V	1.300	900	1,5	-	256,5	25	-	239,1	4	6,2
NNC4944-V	1.200	900	2,1	-	-	40	268,5	248	-	17,2
NNCL4944-V	1.200	900	2,1	-	276,52	40	-	248	5	16,8
NNCF5044-V	1.100	800	3	3	312,2	80	297,8	254,6	9	52
NNC4848-V	1.200	900	2	-	-	30	276,7	259,5	-	10
NNCL4848-V	1.200	900	2	-	281,9	30	-	259,5	4	9,9
NNC4948-V	1.100	800	2,1	-	-	40	292,3	270,6	-	18,5
NNCL4948-V	1.100	800	2,1	-	299,46	40	-	270,6	5	17,9
NNCF5048-V	1.000	700	3	3	335,1	80	322,1	277,5	9	55,5
NNC4852-V	1.000	700	2	-	-	30	298,8	281,8	-	11
NNCL4852-V	1.000	700	2	-	304,2	30	-	281,8	4	10,6
NNC4952-V	1.000	700	2,1	-	-	50	322,1	294,5	-	32
NNCL4952-V	1.000	700	2,1	-	331,33	50	-	294,5	6	31,2
NNCF5052-V	900	700	4	4	375,97	95	359,7	304	11	84
NNC4856-V	1.000	700	2	-	-	34,5	326,4	306,8	-	16
NNCL4856-V	1.000	700	2	-	332,4	34,5	-	306,8	4	15,6
NNC4956-V	1.000	700	2,1	-	-	50	344,6	316,5	-	34
NNCL4956-V	1.000	700	2,1	-	353,34	50	-	316,5	6	33
NNCF5056-V	800	600	4	4	390,3	95	374,1	318,3	11	89
NNC4860-V	900	700	2,1	-	-	40	349,9	327,9	-	23
NNCL4860-V	900	700	2,1	-	356,7	40	-	327,9	6	22
NNC4960-V	900	700	3	-	-	59	374,3	340,7	-	53
NNCL4960-V	900	700	3	-	385,51	59	-	340,7	6	52
NNCF5060-V	800	600	4	4	433,6	109	413,6	353,6	12	125
NNC4864-V	800	600	2,1	-	-	40	372,9	350,9	-	24
NNCL4864-V	800	600	2,1	-	379,7	40	-	350,9	6	23
NNC4964-V	800	600	3	-	-	59	401,1	367,5	-	56

\*Dimensiones en mm. / \* Dimensions in mm.

\*\*Masa en kg. / \*\* Mass in kg.



### 2.3.2 Rodamientos de doble hilera completamente llenos de rodillos cilíndricos Double row full complement cylindrical roller bearings

#### RODAMIENTOS LIBRES, DE APOYO, FIJOS / NON-LOCATING, SEMI-LOCATING, LOCATING BEARINGS

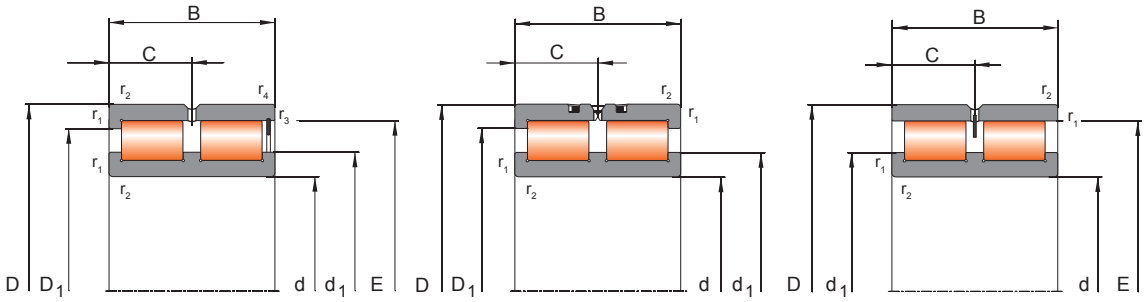

**NNCF50-V**

**NNC-V**

**NNCL-V**

DIMENSIONES* BOUNDARY DIMENSIONS*			DESIGNACION DESIGNATION	DESIGNACION ALTERNATIVA ALTERNATIVE DESIGNATION	E*	CAPACIDAD DE CARGA (kN) LOAD RATING (kN)			CARGA LIM. DE FATIGA / FATIGUE LIMIT LOAD (kN) Cu
d	D	B				dyn. Cr	dyn. E* Cr E*	stat. Cor	
320	440	118	NNCL4964-V	SL02-4964	E*	1.655	1740	4.000	395
	480	218	NNCF5064-V	SL18-5064	E*	3.500	3.650	6.900	650
340	420	80	NNC4868-V	SL01-4868	E*	847	900	2.400	221
	420	80	NNCL4868-V	SL02-4868	E*	847	900	2.400	221
460	118	NNC4968-V	SL01-4968	SL01-4968	E*	1.680	1760	4.200	408
	118	NNCL4968-V	SL02-4968	SL02-4968	E*	1.680	1760	4.200	408
520	243	NNCF5068-V	SL18-5068	SL18-5068	E*	4.200	4350	8.300	750
360	440	80	NNC4872-V	SL01-4872	E*	886	930	2.500	232
	440	80	NNCL4872-V	SL02-4872	E*	886	930	2.500	232
480	118	NNC4972-V	SL01-4972	SL01-4972	E*	1.710	1.810	4.500	423
	118	NNCL4972-V	SL02-4972	SL02-4972	E*	1.710	1.810	4.500	423
540	243	NNCF5072-V	SL18-5072	SL18-5072	E*	4.300	4.450	8.650	790
380	480	100	NNC4876-V	SL01-4876	E*	1.300	1.380	3.645	328
	480	100	NNCL4876-V	SL02-4876	E*	1.300	1.380	3.645	328
520	140	NNC4976-V	SL01-4976	SL01-4976	E*	2.230	2.360	5.500	532
	140	NNCL4976-V	SL02-4976	SL02-4976	E*	2.230	2.360	5.500	532
560	243	NNCF5076-V	SL18-5076	SL18-5076	E*	4.400	4.600	8.950	820
400	500	100	NNC4880-V	SL01-4880	E*	1.360	1.420	3.700	337
	500	100	NNCL4880-V	SL02-4880	E*	1.360	1.420	3.700	337
540	140	NNC4980-V	SL01-4980	SL01-4980	E*	2.250	2.380	5.850	551
540	140	NNCL4980-V	SL02-4980	SL02-4980	E*	2.250	2.380	5.850	551

\*Dimensiones en mm. / \* Dimensions in mm.

\*\*Masa en kg. / \*\* Mass in kg.

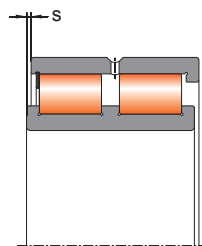

**NNCF50-V**  
Axial Displacement (s)

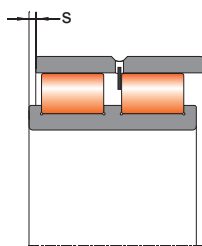

**NNCL-V**  
Axial Displacement (s)

DESIGNACION DESIGNATION	VELOCIDADES LIMITE SPEED RATINGS (rpm)		r <sub>1</sub> , r <sub>2</sub> (min)	r <sub>3</sub> , r <sub>4</sub> (min)	DIMENSIONES SECUNDARIAS SECONDARY DIMENSIONS				MASA** MASS**	
	ng aceite ng oil	ng grasa ng grease			E	C	D <sub>1</sub>	d <sub>1</sub>		s
NNCL4964-V	800	600	3	-	412,27	59	-	367,5	6	55
NNCF5064-V	800	600	4	4	449,5	109	431,5	369,5	12	130
NNC4868-V	800	600	2,1	-	-	40	390,1	368,1	-	25,5
NNCL4868-V	800	600	2,1	-	396,9	40	-	368,1	6	25
NNC4968-V	800	600	3	-	-	59	418,9	385,3	-	59
NNCL4968-V	800	600	3	-	430,11	59	-	385,3	6	58
NNCF5068-V	700	500	5	5	485,65	121,5	465,5	396	14	180
NNC4872-V	800	600	2,1	-	-	40	413,2	391	-	27
NNCL4872-V	800	600	2,1	-	419,8	40	-	391	6	26
NNC4972-V	700	500	3	-	-	59	436,8	404	-	62
NNCL4972-V	700	500	3	-	447,95	59	-	404	6	61
NNCF5072-V	700	500	5	5	503,45	121,5	481	413,8	14	190
NNC4876-V	700	500	2,1	-	-	50	447,2	419	-	45,5
NNCL4876-V	700	500	2,1	-	455,8	50	-	419	6	44
NNC4976-V	700	500	4	-	-	70	468,7	430,2	-	92,4
NNCL4976-V	700	500	4	-	481,35	70	-	430,2	7	90,5
NNCF5076-V	600	400	5	5	521,25	121,5	499	432	14	200
NNC4880-V	700	500	2,1	-	-	50	462	433,8	-	46,5
NNCL4880-V	700	500	2,1	-	470,59	50	-	433,8	6	46
NNC4980-V	600	400	4	-	-	70	489	450,5	-	96,5
NNCL4980-V	600	400	4	-	501,74	70	-	450,5	7	95

\*Dimensiones en mm. / \*Dimensions in mm.  
\*\*Masa en kg. / \*\*Mass in kg.



### 2.3.3 Rodamientos completamente llenos de rodillos cilíndricos sin aro exterior Full complement cylindrical roller bearings without outer ring

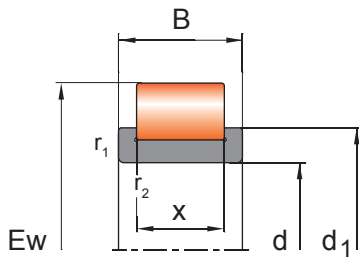

**RN-V**

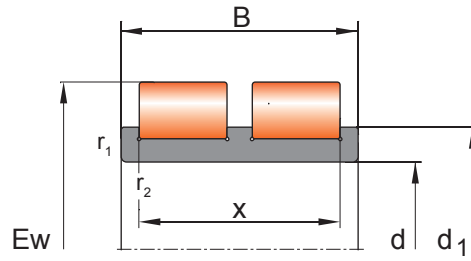

**RNN50-V**

DIMENSIONES* BOUNDARY DIMENSIONS*		DESIGNACION DESIGNATION	DESIGNACION ALTERNATIVA ALTERNATIVE DESIGNATION	E*	CAPACIDAD DE CARGA (kN) LOAD RATING (kN)			
d	Ew				B	dyn. Cr	dyn. E* Cr E*	stat. Cor
20	36,81	30	RNN5004-V	RSL18-5004	E*	51	53	55
	36,81	16	RN3004-V	RSL18-3004	E*	28,8	30	27
	41,47	18	RN2204-V	RSL18-2204	E*	43,6	45,5	38
25	42,51	30	RNN5005-V	RSL18-5005	E*	57	60	68
	42,51	16	RN3005-V	RSL18-3005	E*	33,2	35	32
	46,52	18	RN2205-V	RSL18-2205	E*	48,6	51	45
30	53,717	24	RN2305-V	RSL18-2305	E*	68,6	72	67
	49,6	34	RNN5006-V	RSL18-5006	E*	72	77	86
	49,6	19	RN3006-V	RSL18-3006	E*	42,4	44,5	44
35	55,19	20	RN2206-V	RSL18-2206	E*	66,5	70	62
	62,3	27	RN2306-V	RSL18-2306	E*	93	98	87
	55,52	36	RNN5007-V	RSL18-5007	E*	89	94	112
40	55,52	20	RN3007-V	RSL18-3007	E*	51,8	54	54
	63,97	23	RN2207-V	RSL18-2207	E*	83,6	88	80
	72,68	31	RN2307-V	RSL18-2307	E*	117,6	125	113
45	61,74	38	RNN5008-V	RSL18-5008	E*	106	112	139
	61,74	21	RN3008-V	RSL18-3008	E*	62,7	66	68
	70,94	23	RN2208-V	RSL18-2208	E*	89,9	95	95
50	83,124	33	RN2308-V	RSL18-2308	E*	162,5	170	156
	66,85	40	RNN5009-V	RSL18-5009	E*	114	120	155
	66,85	23	RN3009-V	RSL18-3009	E*	64,9	69	74
55	74,43	23	RN2209-V	RSL18-2209	E*	94,3	100	100
	88,322	36	RN2309-V	RSL18-2309	E*	170	180	174
	72,33	40	RNN5010-V	RSL18-5010	E*	143	150	195
60	72,33	23	RN3010-V	RSL18-3010	E*	82,9	87,5	94
	81,4	23	RN2210-V	RSL18-2210	E*	103,7	110	120
	98,718	40	RN2310-V	RSL18-2310	E*	219,4	231	220
65	83,54	46	RNN5011-V	RSL18-5011	E*	189	200	280
	83,54	26	RN3011-V	RSL18-3011	E*	112,6	118	137
	88,81	25	RN2211-V	RSL18-2211	E*	133,7	140	155
70	109,11	43	RN2311-V	RSL18-2311	E*	257,2	270	259
	86,74	46	RNN5012-V	RSL18-5012	E*	198	210	295

\*Dimensiones en mm. / \* Dimensions in mm.

\*\*Masa en kg. / \*\* Mass in kg.

DESIGNACION DESIGNATION	CARGA LIM. DE FATIGA FATIGUE LIMIT LOAD (kN)	VELOCIDADES LIMITE SPEED RATINGS (rpm) ng aceite ng oil	r <sub>1</sub> , r <sub>2</sub> (min)	DIMENSIONES SECUNDARIAS SECONDARY DIMENSIONS		MASA** MASS**
				d <sub>i</sub>	x	
RNN5004-V	8,5	10.400	0,6	28,4	23	0,12
RN3004-V	4,2	10.200	0,6	28,8	9	0,06
RN2204-V	5,8	9.400	1	30,3	12	0,1
RNN5005-V	10,5	8.900	0,6	34,5	23	0,15
RN3005-V	5,2	8.700	0,6	34,6	9	0,08
RN2205-V	7	8.200	1	35,3	12	0,12
RN2305-V	8,9	7.200	1,1	36,7	15	0,21
RNN5006-V	14,3	7.600	1	40	26	0,22
RN3006-V	7,1	7.400	1	40	10	0,12
RN2206-V	9,7	6.900	1	42	14	0,19
RN2306-V	13,8	6.200	1,1	43,5	18	0,33
RNN5007-V	17,5	6.700	1	44,9	28	0,28
RN3007-V	8,9	6.500	1	44,9	11	0,15
RN2207-V	12,1	5.900	1,1	47	15	0,27
RN2307-V	18,1	5.400	1,5	50,7	20	0,5
RNN5008-V	21,3	6.000	1	50,5	30	0,35
RN3008-V	10,6	6.000	1	50,5	12	0,2
RN2208-V	14,2	5.300	1,1	54	15	0,34
RN2308-V	24	4.900	1,5	57,5	24	0,74
RNN5009-V	23,7	5.500	1	55,3	30	0,42
RN3009-V	11,9	5.300	1	55,3	12	0,23
RN2209-V	15,2	4.900	1,1	57,5	15	0,34
RN2309-V	27,1	4.300	1,5	62,5	24	0,84
RNN5010-V	28,5	5.100	1	59,1	33	0,46
RN3010-V	14,3	4.900	1	59,1	14	0,25
RN2210-V	17,2	4.500	1,1	64,4	15	0,41
RN2310-V	36,6	4.000	2	68,3	28	1,2
RNN5011-V	42,8	4.400	1,1	68,5	39	0,86
RN3011-V	21,5	4.300	1,1	68,5	17	0,45
RN2211-V	23,8	4.100	1,5	70	18	0,54
RN2311-V	43,2	3.600	2	75,5	30	1,5
RNN5012-V	45,1	4.000	1,1	71,7	39	0,79

\*Dimensiones en mm. / \* Dimensions in mm.

\*\*Masa en kg. / \*\* Mass in kg.



### 2.3.3 Rodamientos completamente llenos de rodillos cilíndricos sin aro exterior Full complement cylindrical roller bearings without outer ring

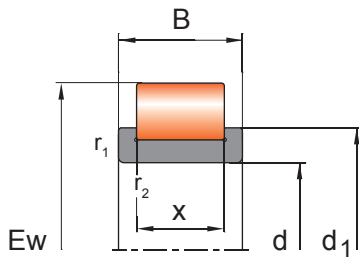

**RN-V**

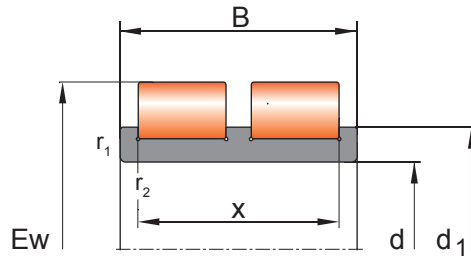

**RNN50-V**

DIMENSIONES* BOUNDARY DIMENSIONS*		B	DESIGNACION DESIGNATION	DESIGNACION ALTERNATIVA ALTERNATIVE DESIGNATION	E*	CAPACIDAD DE CARGA (kN) LOAD RATING (kN)		
d	Ew					dyn. Cr	dyn. E* Cr E*	stat. Cor
60	86,74	26	RN3012-V	RSL18-3012	E*	116,5	123	144
	99,17	28	RN2212-V	RSL18-2212	E*	159,4	167	180
	115,62	46	RN2312-V	RSL18-2312	E*	269,7	285	285
65	93,09	46	RNN5013-V	RSL18-5013	E*	208	220	320
	93,09	26	RN3013-V	RSL18-3013	E*	124	130	163
	106,25	31	RN2213-V	RSL18-2213	E*	187,1	196	220
	126,69	48	RN2313-V	RSL18-2313	E*	325,7	345	358
70	100,28	54	RNN5014-V	RSL18-5014	E*	249	260	350
	100,28	30	RN3014-V	RSL18-3014	E*	142,4	150	173
	111,01	31	RN2214-V	RSL18-2214	E*	171,2	180	225
	132,14	51	RN2314-V	RSL18-2314	E*	354	375	395
75	107,9	54	RNN5015-V	RSL18-5015	E*	254	270	380
	107,9	30	RN3015-V	RSL18-3015	E*	149,8	159	190
	115,78	31	RN2215-V	RSL18-2215	E*	176	185	245
	143,22	55	RN2315-V	RSL18-2315	E*	431	450	476
80	116,99	60	RNN5016-V	RSL18-5016	E*	288	305	450
	116,99	34	RN3016-V	RSL18-3016	E*	162,1	170	225
	125,81	33	RN2216-V	RSL18-2216	E*	212	225	285
	154,24	58	RN2316-V	RSL18-2316	E*	497	525	563
85	121,44	60	RNN5017-V	RSL18-5017	E*	294	310	470
	121,44	34	RN3017-V	RSL18-3017	E*	167,8	175	236
	133,21	36	RN2217-V	RSL18-2217	E*	238	250	330
	163,01	60	RN2317-V	RSL18-2317	E*	513	545	620
90	130,11	67	RNN5018-V	RSL18-5018	E*	339	360	550
	130,11	37	RN3018-V	RSL18-3018	E*	190	200	277
	140,61	40	RN2218-V	RSL18-2218	E*	266,7	280	375
	165,26	64	RN2318-V	RSL18-2318	E*	559	585	657
95	174,66	67	RN2319-V	RSL18-2319	E*	601	630	720
100	139,65	67	RNN5020-V	RSL18-5020	E*	370	390	610
	139,65	37	RN3020-V	RSL18-3020	E*	204	215	307
	162,81	46	RN2220-V	RSL18-2220	E*	369	390	530
	187,303	73	RN2320-V	RSL18-2320	E*	725	765	858

\*Dimensiones en mm. / \* Dimensions in mm.

\*\*Masa en kg. / \*\* Mass in kg.

DESIGNACION DESIGNATION	CARGA LIM. DE FATIGA FATIGUE LIMIT LOAD (kN) Cu	VELOCIDADES LIMITE SPEED RATINGS (rpm) ng aceite ng oil	r <sub>1</sub> , r <sub>2</sub> (min)	DIMENSIONES SECUNDARIAS SECONDARY DIMENSIONS		MASA** MASS**
				d <sub>i</sub>	x	
RN3012-V	22,5	4.100	1,1	71,7	17	0,43
RN2212-V	29,5	3.700	1,5	76,8	20	0,76
RN2312-V	47,5	3.300	2,1	82	30	1,8
RNN5013-V	49,4	3.800	1,1	78,1	39	0,94
RN3013-V	24,7	3.800	1,1	78,1	17	0,5
RN2213-V	35,2	3.400	1,5	82,3	22	0,95
RN2313-V	59,9	3.100	2,1	90	34	2,4
RNN5014-V	45	3.600	1,1	81,5	42	1,1
RN3014-V	28	3.500	1,1	81,5	18	0,6
RN2214-V	30,4	3.200	1,5	87	22	1
RN2314-V	65,6	2.900	2,1	93,5	36	2,6
RNN5015-V	49	3.300	1,1	89	42	1,5
RN3015-V	30,9	3.300	1,1	89	18	0,73
RN2215-V	31,8	3.100	1,5	91,8	22	1
RN2315-V	78,9	2.700	2,1	101,6	40	3,4
RNN5016-V	58,9	3.100	1,1	95	47	1,8
RN3016-V	29,5	3.100	1,1	95	20	0,97
RN2216-V	36,6	2.900	2	98,6	24	1,3
RN2316-V	91,2	2.500	2,1	109,5	44	4,3
RNN5017-V	60,8	3.000	1,1	99	47	1,9
RN3017-V	30,4	2.900	1,1	99,4	20	1
RN2217-V	42,3	2.700	2	104,4	26	1,6
RN2317-V	97,9	2.400	3	118,2	44	4,6
RNN5018-V	69,5	2.800	1,5	106,1	52	2,5
RN3018-V	36,1	2.700	1,5	106,1	22	1,3
RN2218-V	48,5	2.500	2	110,2	28	2
RN2318-V	106	2.300	3	117,5	48	5,2
RN2319-V	114	2.100	3	126,6	48	6
RNN5020-V	77	2.600	1,5	115,7	52	2,6
RN3020-V	38,5	2.500	1,5	115,7	22	1,4
RN2220-V	66,5	2.300	2,1	127,5	34	3,4
RN2320-V	136	2.000	3	132,7	55	7,8

\*Dimensiones en mm. / \* Dimensions in mm.

\*\*Masa en kg. / \*\* Mass in kg.



### 2.3.3 Rodamientos completamente llenos de rodillos cilíndricos sin aro exterior Full complement cylindrical roller bearings without outer ring

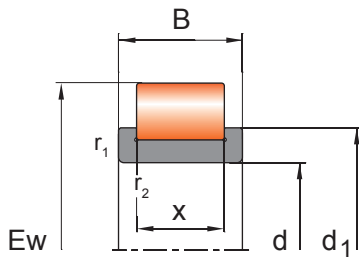

**RN-V**

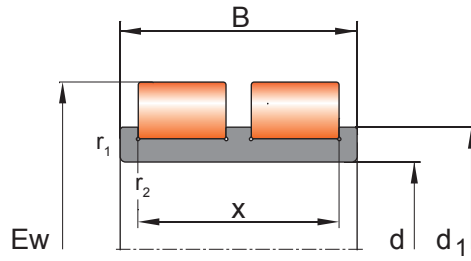

**RNN50-V**

DIMENSIONES* BOUNDARY DIMENSIONS*	d	Ew	B	DESIGNACION DESIGNATION	DESIGNACION ALTERNATIVA ALTERNATIVE DESIGNATION	E*	CAPACIDAD DE CARGA (kN) LOAD RATING (kN)		
							dyn. Cr	dyn. E* Cr E*	stat. Cor
110	156,13	80	RNN5022-V	RSL18-5022	E*	476	500	780	
	156,13	45	RN3022-V	RSL18-3022	E*	267	280	386	
	177	53	RN2222-V	RSL18-2222	E*	429	450	580	
	218,27	80	RN2322-V	RSL18-2322	E*	891	930	1.050	
120	167,58	80	RNN5024-V	RSL18-5024	E*	510	535	880	
	167,58	46	RN3024-V	RSL18-3024	E*	283	295	430	
	192,32	58	RN2224-V	RSL18-2224	E*	503	525	730	
	231,386	86	RN2324-V	RSL18-2324	E*	1.020	1.080	1.250	
130	183,81	95	RNN5026-V	RSL18-5026	E*	727	760	1240	
	183,81	52	RN3026-V	RSL18-3026	E*	397	420	604	
	297,12	64	RN2226-V	RSL18-2226	E*	580	610	870	
	247,9	93	RN2326-V	RSL18-2326	E*	1.170	1.240	1.410	
140	197,82	95	RNN5028-V	RSL18-5028	E*	756	800	1.370	
	197,82	53	RN3028-V	RSL18-3028	E*	425	450	665	
	221,92	68	RN2228-V	RSL18-2228	E*	689	720	1.005	
	264,447	102	RN2328-V	RSL18-2328	E*	1.320	1.405	1.575	
150	206,8	100	RNN5030-V	RSL18-5030	E*	792	830	1.430	
	206,8	56	RN3030-V	RSL18-3030	E*	447	470	708	
	236,71	73	RN2230-V	RSL18-2230	E*	777	810	1.170	
	286,49	108	RN2330-V	RSL18-2330	E*	1.525	1.610	1.900	
160	224,8	109	RNN5032-V	RSL18-5032	E*	886	940	1.600	
	224,8	60	RN3032-V	RSL18-3032	E*	512	540	800	
	266,36	80	RN2232-V	RSL18-2232	E*	980	1.030	1.490	
170	242,85	122	RNN5034-V	RSL18-5034	E*	1.155	1.215	2.120	
	242,85	67	RN3034-V	RSL18-3034	E*	650	690	1.055	
	281,09	86	RN2234-V	RSL18-2234	E*	1.040	1.100	1.680	
180	260,22	136	RNN5036-V	RSL18-5036	E*	1.340	1.410	2.500	
	260,22	74	RN3036-V	RSL18-3036	E*	759	800	1.250	
	293,22	86	RN2236-V	RSL18-2236	E*	1.090	1.150	1.775	
190	269,76	136	RNN5038-V	RSL18-5038	E*	1.380	1.460	2.600	
	269,76	75	RN3038-V	RSL18-3038	E*	765	810	1.290	
	310,68	92	RN2238-V	RSL18-2238	E*	1.210	1.280	1.900	

\*Dimensiones en mm. / \* Dimensions in mm.

\*\*Masa en kg. / \*\* Mass in kg.



DESIGNACION DESIGNATION	CARGA LIM. DE FATIGA FATIGUE LIMIT LOAD (kN) Cu	VELOCIDADES LIMITE SPEED RATINGS (rpm) ng aceite ng oil	r <sub>1</sub> , r <sub>2</sub> (min)	DIMENSIONES SECUNDARIAS SECONDARY DIMENSIONS		MASA** MASS**
				d <sub>i</sub>	x	
RNN5022-V	98,8	2.200	2	127,3	62	4
RN3022-V	49,4	2.300	2	127,3	26	2,1
RN2222-V	74,1	2.000	2,1	137	36	4,2
RN2322-V	148	1.800	3	151,1	56	11,5
RNN5024-V	106	2.100	2	138,8	62	4,6
RN3024-V	53,2	2.100	2	138,8	26	2,4
RN2224-V	90,3	1.900	2,1	150,7	40	5,6
RN2324-V	185	1.700	3	164,2	64	14,3
RNN5026-V	150	1.900	2	148,6	78	6,7
RN3026-V	75,1	1.900	2	148,6	34	3,5
RN2226-V	105	1.800	3	162,3	44	7,1
RN2326-V	205	1.400	4	176	68	17,4
RNN5028-V	160	1.800	2	162,6	78	7,9
RN3028-V	80,8	1.800	2	162,2	34	4,1
RN2228-V	121	1.600	3	173,9	48	8,7
RN2328-V	229	1.300	4	187,8	72	21,1
RNN5030-V	166	1.700	2	170	80	8,2
RN3030-V	83,6	1.600	2,1	170	34	4,4
RN2230-V	140	1.400	3	185,5	52	10,5
RN2330-V	252	1.200	4	203,3	80	27,2
RNN5032-V	189	1.600	2,1	184,8	86	11
RN3032-V	94,1	1.600	2,1	184,8	36	5,8
RN2232-V	169	1.400	3	208,7	58	16
RNN5034-V	247	1.400	2,1	198	100	15,6
RN3034-V	123	1.500	2,1	198,1	44	8,2
RN2234-V	189	1.300	4	220,3	62	19,2
RNN5036-V	280	1.300	2,1	212,2	110	20,5
RN3036-V	143	1.300	2,1	212,2	48	10,7
RN2236-V	198	1.200	4	232,4	62	20,7
RNN5038-V	300	1.300	2,1	221,8	110	21,2
RN3038-V	147	1.300	2,1	221,8	48	11,3
RN2238-V	212	1.100	4	243,5	64	24

\*Dimensiones en mm. / \* Dimensions in mm.

\*\*Masa en kg. / \*\* Mass in kg.



### 2.3.3 Rodamientos completamente llenos de rodillos cilíndricos sin aro exterior Full complement cylindrical roller bearings without outer ring

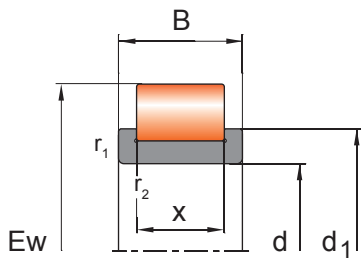

**RN-V**

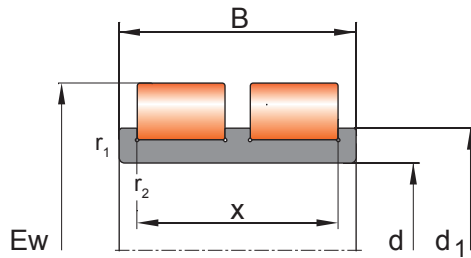

**RNN50-V**

DIMENSIONES* BOUNDARY DIMENSIONS*			DESIGNACION DESIGNATION	DESIGNACION ALTERNATIVA ALTERNATIVE DESIGNATION	E*	CAPACIDAD DE CARGA (kN) LOAD RATING (kN)		
d	Ew	B				dyn. Cr	dyn. E* Cr E*	stat. Cor
200	287,75	150	RNN5040-V	RSL18-5040	E*	1.550	1.660	3.000
	287,75	82	RN3040-V	RSL18-3040	E*	900	940	1.510
	318,6	98	RN2240-V	RSL18-2240	E*	1.330	1.410	2.050

\*Dimensiones en mm. / \* Dimensions in mm.  
\*\*Masa en kg. / \*\* Mass in kg.

DESIGNACION DESIGNATION	CARGA LIM. DE FATIGA FATIGUE LIMIT LOAD (kN) Cu	VELOCIDADES LIMITE SPEED RATINGS (rpm) ng aceite ng oil	r <sub>1</sub> , r <sub>2</sub> (min)	DIMENSIONES SECUNDARIAS SECONDARY DIMENSIONS		MASA** MASS**
				d <sub>i</sub>	x	
RNN5040-V	340	1.200	2,1	236,6	120	27,4
RN3040-V	169	1.200	2,1	236,6	52	14,4
RN2240-V	223	1.100	4	246,6	68	26

\*Dimensiones en mm. / \* Dimensions in mm.

\*\*Masa en kg. / \*\* Mass in kg.



# 2.4

de dos hileras completamente llenas de rodillos cilíndricos  
 de cables  
 Full complement cylindrical roller bearings for cable sheaves

LOCKING BEARINGS

BEARINGS EUROPE NBI

RODAMIENTOS DE RODILLOS CILÍNDRICOS • CYLINDRICAL ROLLER BEARINGS

DIMENSIONES BOUNDARY DIMENSIONS	DESIGNACIÓN DESIGNATION	DESIGNACIÓN ALTERNATIVA ALTERNATIVE DESIGNATION	CAPACIDAD DE CARGA LOAD CAPACITY	VELOCIDAD SPEED	ESPESES THICKNESS	ESPESES THICKNESS	ESPESES THICKNESS	ESPESES THICKNESS					
d	D	B	C	d <sub>1</sub>	d <sub>2</sub>	d <sub>3</sub>	d <sub>4</sub>	d <sub>5</sub>					
20	47	30	23	NBI502-PP-N	S0A-502-PP	11,4	45,8	51,8	6,2	2,70	0,2	20,15	62,3
25	47	35	23	NBI502-PP-N	S0A-502-PP	11,4	45,8	51,8	6,2	2,70	0,2	20,15	62,3
30	55	34	23	NBI502-PP-N	S0A-502-PP	11,4	45,8	51,8	6,2	2,70	0,2	20,15	62,3
35	55	39	23	NBI502-PP-N	S0A-502-PP	11,4	45,8	51,8	6,2	2,70	0,2	20,15	62,3
40	62	38	23	NBI502-PP-N	S0A-502-PP	11,4	45,8	51,8	6,2	2,70	0,2	20,15	62,3
45	75	40	23	NBI502-PP-N	S0A-502-PP	11,4	45,8	51,8	6,2	2,70	0,2	20,15	62,3
50	85	40	23	NBI502-PP-N	S0A-502-PP	11,4	45,8	51,8	6,2	2,70	0,2	20,15	62,3
55	95	46	23	NBI502-PP-N	S0A-502-PP	11,4	45,8	51,8	6,2	2,70	0,2	20,15	62,3
60	105	46	23	NBI502-PP-N	S0A-502-PP	11,4	45,8	51,8	6,2	2,70	0,2	20,15	62,3
65	115	54	23	NBI502-PP-N	S0A-502-PP	11,4	45,8	51,8	6,2	2,70	0,2	20,15	62,3
70	115	54	23	NBI502-PP-N	S0A-502-PP	11,4	45,8	51,8	6,2	2,70	0,2	20,15	62,3
75	125	60	23	NBI502-PP-N	S0A-502-PP	11,4	45,8	51,8	6,2	2,70	0,2	20,15	62,3
80	130	60	23	NBI502-PP-N	S0A-502-PP	11,4	45,8	51,8	6,2	2,70	0,2	20,15	62,3
85	140	67	23	NBI502-PP-N	S0A-502-PP	11,4	45,8	51,8	6,2	2,70	0,2	20,15	62,3
90	145	67	23	NBI502-PP-N	S0A-502-PP	11,4	45,8	51,8	6,2	2,70	0,2	20,15	62,3
95	155	67	23	NBI502-PP-N	S0A-502-PP	11,4	45,8	51,8	6,2	2,70	0,2	20,15	62,3
100	170	75	23	NBI502-PP-N	S0A-502-PP	11,4	45,8	51,8	6,2	2,70	0,2	20,15	62,3
105	170	75	23	NBI502-PP-N	S0A-502-PP	11,4	45,8	51,8	6,2	2,70	0,2	20,15	62,3
110	180	80	23	NBI502-PP-N	S0A-502-PP	11,4	45,8	51,8	6,2	2,70	0,2	20,15	62,3
120	195	80	23	NBI502-PP-N	S0A-502-PP	11,4	45,8	51,8	6,2	2,70	0,2	20,15	62,3
140	200	90	23	NBI502-PP-N	S0A-502-PP	11,4	45,8	51,8	6,2	2,70	0,2	20,15	62,3
150	210	90	23	NBI502-PP-N	S0A-502-PP	11,4	45,8	51,8	6,2	2,70	0,2	20,15	62,3
160	220	95	23	NBI502-PP-N	S0A-502-PP	11,4	45,8	51,8	6,2	2,70	0,2	20,15	62,3
170	235	95	23	NBI502-PP-N	S0A-502-PP	11,4	45,8	51,8	6,2	2,70	0,2	20,15	62,3
180	240	95	23	NBI502-PP-N	S0A-502-PP	11,4	45,8	51,8	6,2	2,70	0,2	20,15	62,3
190	240	95	23	NBI502-PP-N	S0A-502-PP	11,4	45,8	51,8	6,2	2,70	0,2	20,15	62,3
200	250	95	23	NBI502-PP-N	S0A-502-PP	11,4	45,8	51,8	6,2	2,70	0,2	20,15	62,3

RODAMIENTOS DE RODILLOS CILÍNDRICOS • CYLINDRICAL ROLLER BEARINGS

Rodamientos de dos hileras completamente llenos de rodillos cilíndricos para poleas de cable  
*Double row full complement cylindrical roller bearings for cable sheaves*



## 2.4 Rodamientos de dos hileras completamente llenos de rodillos cilíndricos para poleas de cable

### Double row full complement cylindrical roller bearings for cable sheaves

índice

Características técnicas .....	128
Anillos de retención .....	129
Obturaciones PP .....	129
Recubrimiento anti-corrosión .....	129
Lubricación .....	130
Desalineación .....	131
Tolerancias .....	131
Juego radial interno .....	131
Juego radial interno no estándar .....	131
Temperatura de funcionamiento .....	133
Carga mínima .....	133
Capacidad de carga axial dinámica .....	133
Carga dinámica equivalente .....	134
Carga estática equivalente .....	134
Dimensiones de los chaflanes .....	134
Designaciones complementarias .....	135
Tabla de dimensiones .....	138

index

Technical characteristics .....	128
Appropriate snap rings .....	129
PP Sealing .....	129
Anti corrosion coating .....	129
Lubrication .....	130
Misalignment .....	131
Tolerances .....	131
Internal radial clearance .....	131
Non-standardized internal clearance .....	131
Operating temperature .....	133
Minimum load .....	133
Dynamic axial load carrying capacity .....	133
Equivalent dynamic bearing load .....	134
Equivalent static bearing load .....	134
Abutment and fillet dimensions .....	134
Supplementary designations .....	135
Dimensions table .....	138

#### NBI E<sup>+</sup> - SERIES CON SUPERIORES CAPACIDADES DE CARGA



NBI ha combinado los últimos avances en investigación de materiales y en metalurgia con su experiencia en diseño y fabricación de rodamientos para crear una nueva línea de rodamientos de rodillos cilíndricos con excepcionales prestaciones.

La mejora en la rugosidad de las pistas de rodadura y la optimización de los perfiles de las mismas, junto con el empleo de rodillos de un grado de precisión superior minimizan el rozamiento y optimizan la distribución de la carga. La circulación del lubricante también se favorece con un nuevo diseño de los flancos de guiado de los rodillos en las pistas.

La capacidad de aceptar desalineamientos y la capacidad de carga axial han aumentado como consecuencia de estas mejoras. Para todas las cuestiones acerca de las series NBI E<sup>+</sup>, consulte con nuestro departamento de ingeniería.

#### NBI E<sup>+</sup> - SERIES WITH ENHANCED LOAD RATING CHARACTERISTICS

NBI has combined the latest achievements of metallurgy and material research with its expertise in bearing design and manufacturing to create a new line of cylindrical roller bearings with additional benefits.

Improvements in internal design features optimize the internal load distribution. Lubricant flow is enhanced by newly defined geometry of the bearings functional surfaces.

The ability to accept misalignments plus the axial load carrying capacity have increased due to these improvements. This technical progress allows for working with higher dynamic load ratings. For all questions you may have regarding the NBI E<sup>+</sup> series, please feel free to contact our engineering team.

NNF-PP-V



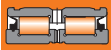

## RODAMIENTOS DE DOS HILERAS COMPLETAMENTE LLENOS DE RODILLOS CILÍNDRICOS PARA POLEAS DE CABLE

### Características técnicas

Los rodamientos NNF-PP-V completamente llenos tienen un anillo interior compuesto por dos piezas y tres pestañas integrales, y se mantiene unido mediante un anillo de retención. El aro exterior tiene una pestaña integral central.

Estos rodamientos se fabrican con dos obturaciones de contacto como norma estándar.

Estos rodamientos se utilizan principalmente como en poleas de cable en grúas o máquinas elevadoras. Los rodamientos NNF-PP-V son muy efectivos soportando grandes cargas radiales y axiales al mismo tiempo. Gracias a su geometría interna, son capaces, además, de soportar momentos flectores.

Como estos rodamientos se utilizan principalmente en poleas de cable, su anillo exterior tiene 1 mm menos de anchura que el anillo interior. Esta característica evita la necesidad de utilizar casquillos o arandelas adicionales.

Como característica estándar, los rodamientos tipo NNF-PP-V completamente llenos de rodillos cilíndricos tienen dos ranuras en su aro exterior.

Esta cualidad permite un sencillo y económico método de montaje de las poleas usando anillos de retención.

Los rodamientos tipo NNF-PP-V se suministran con dos obturaciones de contacto y con grasa de alta calidad.

Estos rodamientos operando en altas velocidades

## DOUBLE ROW FULL COMPLEMENT CYLINDRICAL ROLLER BEARINGS FOR CABLE SHEAVES

### Technical characteristics

NNF-PP-V type full complement bearings have a two piece inner ring having three integral flanges which is held together by a retaining ring for ease of handling and mounting. The outer ring features an integral centre flange.

These bearings are being produced with two contacting seals as standard.

These bearings are being preferably used as rope pulley bearings for cranes and hoisting equipment. NNF-PP-V type bearings are being satisfactory in supporting high radial loads and axial forces acting in both directions. Due to their internal geometry, they can also accommodate tilting moments.

As these bearings are being primarily used as rope sheave bearings, they have an outer ring that is 1 mm less wide than the inner rings. This specific feature allows omitting additional sleeves or washers.

As a standard feature, NNF-PP-V type full complement bearings have two retaining ring grooves in their outer ring.

This feature allows for a simple and cost effective method of mounting rope pulleys by using snap rings.

As NNF-PP-V type bearings are standard fitted with two contacting seals they are supplied grease filled by the factory with a high quality bearing grease.



o en condiciones difíciles (por ejemplo, la presencia de agua de mar, mucha humedad, presencia de contaminantes, etc.) requieren una lubricación más frecuente.

Para permitir una lubricación sencilla, los rodamientos se fabrican con dos posibilidades independientes de lubricación; pueden lubricarse mediante los agujeros de lubricación del aro interior y mediante los agujeros y ranuras de lubricación del aro exterior.

### Anillos de retención

Como característica estandarizada, los rodamientos completamente llenos tipo NNF-PP-V tienen dos ranuras para anillos de retención en sus aros exteriores para una simple y económica forma de montar poleas de cable, usando los anillos de retención WRE, WR, o cualquier anillo de retención estándar DIN 471.

Estos anillos de retención no se suministran con los rodamientos.

### Obturaciones PP

Los rodamientos NNF-PP-V tienen obturaciones de contacto a cada lado hechas de un poliuretano especialmente resistente. Las obturaciones están montadas sobre los bordes del aro interior y el labio sellador ejerce una pequeña presión sobre el aro exterior.

Estos cierres proporcionan una protección efectiva ante el polvo, contaminación y salpicaduras de agua.

Los rodamientos NNF-PP-V se pueden suministrar con otros tipos de obturaciones rozantes y con obturaciones metálicas bajo pedido.

### Recubrimiento anti-corrosión

Los rodamientos de NBI tipo NNF-PP-V completamente llenos de rodillos pueden incorporar una protección efectiva contra la oxidación, sufijo

Bearings of the series NNF-PP-V operating at high speeds or under harsh conditions (e.g. the presence of salt water, high humidity, contaminants etc.) require more frequent lubrication.

For simple relubrication, the bearings are manufactured with two independent working relubrication possibilities; these bearings can get lubricated via lubricating grooves and bores in the inner rings or, alternatively, via the lubrication groove and holes in the outer ring.

### Appropriate snap rings

As a standard feature, NNF-PP-V type full complement bearings have two retaining ring grooves in their outer ring for a simple and cost effective method of mounting rope pulleys, etc. by using WRE and WR type snap rings or standard snap rings according to DIN 471.

These snap rings are being not supplied with the bearings.

### PP Sealing

NNF-PP-V bearings have contacting seals fitted to either side of the bearing as standard these seals are made from specifically resistant Polyurethane. The seals are mounted on the inner ring shoulders and contact the outer ring raceway with light preload on the sealing lip.

These seals provide an efficient sealing against dust, contamination and splash water or water spray.

NNF-PP-V can be supplied with different special seals or metal shields on order request.

### Anti corrosion coating

NBI NNF-PP-V type full complement cylindrical roller bearings can be supplied with an effective anti rust protection, suffix CE05.



## 2.4 Rodamientos de dos hileras completamente llenos de rodillos cilíndricos para poleas de cable

*Double row full complement cylindrical roller bearings for cable sheaves*

CE05.

Este recubrimiento permite que los rodamientos funcionen en ambientes corrosivos, i.e. salpicaduras de agua salada o polvo.

### Lubricación

Cuando trabajan en condiciones difíciles, como con la presencia de agua salada, alta humedad, contaminantes, etc. o cuando operan a gran velocidad, estos rodamientos necesitan una lubricación más frecuente. Gracias a su diseño, el rodamiento puede lubricarse tanto por el aro interior como por el exterior.

Durante la lubricación de los rodamientos NNF-PP-V, hay que dedicar especial atención para que las obturaciones no sean expulsadas por la presión.

Deben seguirse las siguientes recomendaciones:

- Asegurarse de que se está utilizando la grasa correcta
- Asegurarse de que esa grasa está limpia de contaminación
- Aplicar la grasa lentamente hasta que la grasa antigua sea expulsada del rodamiento
- Asegurarse de que las obturaciones no son expulsadas por la presión de la grasa. Si es necesario, sujetar las obturaciones PP con arandelas para prevenir su expulsión

Si se necesitan rodamientos con una sola obturación o sin ellas, se pueden retirar fácilmente con un destornillador. Para las aplicaciones que requieran una lubricación con aceite, los rodamientos se pueden suministrar, bajo pedido, sin obturaciones ni grasa. De otro modo se deberán retirar las obturaciones y lavar los rodamientos antes de su uso. Si se utiliza una lubricación con aceite, se puede incrementar la velocidad límite establecida de rodamientos aproximadamente un 30%.

This coating allows bearings to work even under aggressive environments, i.e., salt water spray or dust.

### Lubrication

When working under harsh conditions, such as the presence of salt water, high humidity contaminants etc.) or when operating at high speeds, these bearings require a more frequent re-lubrication. Due to the specific design of the bearing, a re-lubrication can be performed either through the inner ring as well as via the outer ring.

When re-greasing NNF-PP-V bearings, particular care must be applied in order to prevent the seals from popping out of the bearings during re-greasing.

Following guidelines apply:

- make sure that the correct grease type is being used
- make sure that the grease is clean and free from any contamination
- apply the grease slowly until the old grease is being squeezed out of the bearing
- make sure that the seals are not getting squeezed out by the grease pressure. If necessary, support the PP-seals with washers to prevent them from being squeezed out

If bearings with one or no seals are required, the seals may be removed easily by using a screwdriver. For applications where oil lubrication is used, the bearings can be delivered, under purchase order, without seals and grease. Otherwise the seals should be removed and the bearings washed before use. If oil lubrication is used, the speed limits quoted in the product tables can be increased by approximately 30%.

NBI NNF-PP-V cylindrical roller bearings can be supplied with special grease (suffix -L01) for low temperatures (-40°C).

Los rodamientos NBI tipo NNF-PP-V pueden suministrarse con grasa especial (sufijo -L01) para bajas temperaturas (-40 °C).

### Desalineación

Los rodamientos de dos hileras completamente llenos de rodillos cilíndricos no son capaces de absorber desalineación.

### Tolerancias

Los rodamientos completamente llenos de rodillos cilíndricos NBI se fabrican, como estándar, con una tolerancia normal PN.

En el capítulo *Datos de los rodamientos/Tolerancias* se ofrece una información más detallada acerca de las clases de tolerancia.

En caso de los rodamientos con recubrimiento anticorrosión, sufijo CE05, las tolerancias se aplican a los rodamientos antes de aplicado el recubrimiento.

### Juego radial interno

Los rodamientos completamente llenos de rodillos cilíndricos NBI se fabrican, de forma estándar, con juego interno normal (grupo CN).

Los rodamientos NBI también se pueden fabricar en otros grupos de tolerancia bajo pedido.

Estos valores están estandarizados y son conformes a los estándares internacionales en vigor, DIN 620 parte 4 e ISO 5753-1.

Los valores de los diferentes grupos de juego interno de los rodamientos obturados, de doble hilera de rodillos cilíndricos para poleas de cable NBI se listan en la tabla 1.

### Juego radial interno especial

Los rodamientos de dos hileras completamente llenos de rodillos cilíndricos NBI también pueden

### Misalignment

Double row full complement cylindrical roller bearings are not able to absorb a misalignment.

### Tolerances

NBI full complement cylindrical roller bearings are produced to tolerance class PN as standard.

For obtaining detailed values on tolerances refer to the chapter *Bearing data and Tolerances*.

In case of bearings having anti corrosion coating, i.e. suffix CE05, the tolerances apply to the bearings in uncoated condition.

### Internal radial clearance

NBI full complement cylindrical roller bearings are produced to normal internal clearance group (group CN) as standard.

NBI bearings can also be produced to other clearance groups to customers order.

The clearance values correspond, as far as they are standardized, to the relevant international standards DIN 620 part 4 and ISO 5753-1.

The values of the different internal clearance groups of seals, double row NBI cylindrical roller bearings for rope sheaves are listed in table 1.

### Special internal clearance

NBI sealed, double row full complement cylindrical roller bearings for rope sheaves can also be produced with individually defined special internal clearances to customers order.

This includes the possibility of producing bearings with a clearance restricted to a part of the full

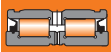

2.4 Rodamientos de dos hileras completamente llenos de rodillos cilíndricos para poleas de cable  
*Double row full complement cylindrical roller bearings for cable sheaves*

Juego radial interno en  $\mu\text{m}$  de los rodamientos NBI obturados, completamente llenos de rodillos cilíndricos, para poleas de cable  
*Internal radial clearance in  $\mu\text{m}$  of NBI sealed full complement cylindrical roller bearings for rope sheaves*

Juego radial Clearance group	Diámetro de eje / Bore diameter (mm)														
	>	-	24	30	40	50	65	80	100	120	140	160	180	200	225
	≤	24	30	40	50	65	80	100	120	140	160	180	200	225	250
C2	min	0	0	5	5	10	10	15	15	15	20	25	35	45	45
	max	25	25	30	35	40	45	50	55	60	70	75	90	105	110
CN	min	20	20	25	30	40	40	50	50	60	70	75	90	105	110
	max	45	45	50	60	70	75	85	90	105	120	125	145	165	175
C3	min	35	35	45	50	60	65	75	85	100	115	120	140	160	170
	max	60	60	70	80	90	100	110	125	145	165	170	195	220	235
C4	min	50	50	60	70	80	90	105	125	145	165	170	195	220	235
	max	75	75	85	100	110	125	140	165	190	215	220	250	280	300
C5	min	75	75	85	100	110	125	140	165	190	215	220	250	280	300
	max	100	100	110	130	140	160	175	205	235	265	270	305	340	365

Juego radial Clearance group	Diámetro de eje / Bore diameter (mm)														
	>	250	280	315	355	400	450	500	560	630	710	800	900	1.000	1.120
	≤	280	315	355	400	450	500	560	630	710	800	900	1.000	1.120	1.250
C2	min	55	55	65	100	110	110	120	140	145	150	180	200	220	230
	max	125	130	145	190	210	220	240	260	285	310	350	390	430	470
CN	min	125	130	145	190	210	220	240	260	285	310	350	390	430	470
	max	195	205	225	280	310	330	360	380	425	470	520	580	640	710
C3	min	190	200	225	280	310	330	360	380	425	470	520	580	640	710
	max	260	275	305	370	410	440	480	500	565	630	690	770	850	950
C4	min	260	275	305	370	410	440	480	500	565	630	690	770	850	950
	max	330	350	385	460	510	550	600	620	705	790	860	960	1.060	1.190
C5	min	330	350	385	460	510	550	600	620	705	790	860	960	1.060	1.510
	max	400	425	465	550	610	660	720	740	845	950	1.030	1.150	1.270	1.750

Tabla 1. Table 1

fabricarse con juegos internos especificados individualmente bajo pedido.

Esto incluye la posibilidad de suministrar rodamientos con un juego restringido a una parte de la banda de tolerancia.

### Temperatura de funcionamiento

Restringido por el material de la obturación y la grasa, los rodamientos NNF-PP-V pueden operar entre temperaturas de -20 °C a +80°C.

Bajo pedido, se pueden equipar con obturaciones especiales (sufijo -2Z) para incrementar el límite superior hasta +120 °C o con una grasa especial (sufijo -L01) para bajas temperaturas para reducir el límite inferior hasta -40°C.

### Carga mínima

Los rodamientos en general requieren una carga mínima radial para evitar la fricción por deslizamiento. En el caso de los rodamientos completamente llenos de rodillos cilíndricos, se requiere una carga radial mínima del 4% de la capacidad de carga dinámica Cr.

### Capacidad de carga axial dinámica

Los rodamientos completamente llenos de rodillos cilíndricos están diseñados primordialmente para resistir cargas radiales. Aun así, pueden aguantar fuerzas axiales actuando en una o dos direcciones hasta un cierto límite.

Las fuerzas axiales aplicadas a los rodamientos de rodillos cilíndricos generan fricción entre la cara lateral del rodillo y los flancos de guiado laterales.

Por eso es esencial una lubricación óptima. Además, cualquier esfuerzo axial origina un momento flector en los rodillos.

Esto requiere una carga radial adicional para asegurar el correcto funcionamiento del rodamiento.

clearance range.

### Operating temperature

Restricted by the seal material and the grease, NNF50-PP-V bearings are suitable for operating temperatures from -20 °C to +80 °C.

Under request, the bearings can be supplied with special seals (suffix -2Z) to increase the maximum operating temperature to +120 °C or with special grease (suffix -L01) for extreme temperatures to decrease the lower limit to -40 °C.

### Minimum load

Rolling bearings require a sufficient minimum radial load to prevent excessive sliding friction. Particularly full complement cylindrical roller bearings require a minimum radial load of more than 4% of the dynamic load rating Cr.

### Dynamic axial load carrying capacity

NNF50-PP-V type full complement cylindrical roller bearings are primarily designed to accommodate radial loads. However, they are also suitable to accept thrust forces acting in one or both directions to a limited extent.

Thrust forces applied to cylindrical roller bearings generate sliding friction between the roller end faces and the guiding flanges.

Hence, an optimum lubrication is crucial. Furthermore, every thrust load creates a tilting moment on the rollers.

This requires an additional radial loading to ensure an effective function of the bearing.

For all these reasons together with the existence of grooves in the outer ring, in the case of cylindrical roller bearings with snap ring grooves, Application Engineering advice is necessary. Please, consult NBI Application Engineering de-

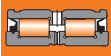

Por estas razones junto con la existencia de ranuras en el aro exterior, en el caso de rodamientos de rodillos cilíndricos con ranuras para los anillos de retención, es necesario el consejo de la Ingeniería de Aplicaciones. Por favor, consulten al departamento de Ingeniería de Aplicaciones de NBI si se considera la actuación de cargas axiales.

### Carga dinámica equivalente

Para rodamientos NNF-PP-V cargados solo radialmente, se aplica:

$$P = F_r$$

En el caso de aplicación de cargas axiales:

Si  $\frac{F_a}{F_r} \leq 0,15$ , entonces:  $P = F_r$

O si  $\frac{F_a}{F_r} > 0,15$ , entonces:  $P = 0,92 \cdot F_r + 0,4 \cdot F_a$

### Carga estática equivalente

Para los rodamientos completamente llenos de rodillos cilíndricos NBI, se aplica:

$$P_0 = F_r$$

### Dimensiones de los chaflanes

Los resaltes de las piezas de maquinaria adyacentes se deben diseñar de forma que garanticen el soporte axial requerido por los aros de los rodamientos.

Los aros de los rodamientos deben contactar con las piezas adyacentes solo a través de sus caras laterales.

Los chaflanes de los rodamientos no deben contactar con los redondeos del eje ni del alojamiento.

Por tanto, el radio máximo del chaflán ( $r_g$ ) debe ser menor que el chaflán mínimo de los aros del

partamento when axial loads are expected.

### Equivalent dynamic bearing load

For only radially loaded NNF-PP-V bearings apply:

$$P = F_r$$

In case of thrust loads, the following formula applies:

If  $\frac{F_a}{F_r} \leq 0,15$ , then:  $P = F_r$

Or if  $\frac{F_a}{F_r} > 0,15$ , then:  $P = 0,92 \cdot F_r + 0,4 \cdot F_a$

### Equivalent static bearing load

For NBI full complement cylindrical roller bearings apply:

$$P_0 = F_r$$

### Abutment and fillet dimensions

The shoulders on adjacent machine parts must be designed in such a way that the required axial support of the bearing rings is guaranteed.

The bearing rings must contact adjacent parts with their side faces only.

The bearing chamfers must not contact the shoulder fillet radii of shaft or housing shoulders.

Therefore, the largest fillet radius ( $r_g$ ) must be kept smaller than the minimum fillet dimension of the bearing rings ( $r_s$ ) as listed in the product tables.

Recommendations for the dimensions of adjacent parts are given in DIN 5418.

rodamiento ( $r_s$ ), tal y como se expone en las tablas del producto.

En la norma DIN 5418 se proporcionan directrices para dimensionar las partes adyacentes.

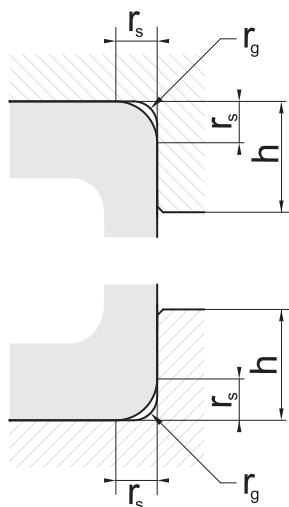

Fig. 1

$r_s$ min	$r_g$ max	$h_{min}$
0,3	0,3	1
0,6	0,6	1,6
1	1	2,3
1,1	1	3
1,5	1,5	3,5
2	2	4,4
2,1	2,1	5,1
3	2,5	6,2
4	3	7,3
5	4	9

Tabla 2. Table 2

### Designaciones complementarias

Las tablas de producto recogen las configuraciones del rodamiento estandarizadas en la fecha de edición de este catálogo. Dichas configuraciones estandarizadas se reflejan en el correspondiente sufijo o sufijos de cada rodamiento.

En cualquier caso, NBI puede ofrecer, bajo pedido, diseños alternativos, tanto los recogidos en la tabla siguiente como otros muchos cuya relación excede el propósito del presente catálogo y que podrán encontrarse en las publicaciones técnicas específicas de aplicaciones concretas o de series de rodamientos concretos.

En caso de requerir un diseño especial no recogido en estas páginas, consulten al Departamento Comercial de NBI Bearings Europe.

### Supplementary designations

The product tables show the standardized bearing configurations updated on the edition of this catalogue. These standardized configurations correspond to suffix or suffixes of each bearing.

In any case, NBI can offer, under requirement, alternative designs, comprising the ones showed in the following table or many others, whose mention exceeds the purpose of the present catalogue, and can be found in specific technical publications of concrete applications or series of specific bearings.

Should you need a special design not existent in these pages, please contact our Sales Department in NBI Bearings Europe.

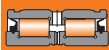

## 2.4 Rodamientos de dos hileras completamente llenos de rodillos cilíndricos para poleas de cable

### Double row full complement cylindrical roller bearings for cable sheaves

Sufijo Suffix	Descripción	Description
<b>C2</b>	Juego radial menor que el normal	Radial internal clearance smaller than normal
<b>C3</b>	Juego radial mayor que el normal	Radial internal clearance larger than normal
<b>C4</b>	Juego radial mayor que C3	Radial internal clearance larger than C3
<b>C5</b>	Juego radial mayor que C4	Radial internal clearance larger than C4
<b>PP</b>	Obturaciones rozantes de poliuretano a ambos lados del rodamiento	Contact seals of polyurethane on both sides of the bearings
<b>V</b>	Completamente lleno de rodillos, sin jaula	Full complement of rollers, without cage
<b>L01</b>	Grasa para bajas temperaturas, hasta -40°C	Grease for low temperature, up to -40°C
<b>L08</b>	Grasa especial con gran resistencia al agua dulce y salada, así como al vapor de agua	Special grease with great resistance to fresh and salt water as well as water vapor
<b>PP3</b>	Obturaciones de poliuretano, especiales para operar bajo el agua, que soportan hasta 4 bar de presión exterior	Machined polyurethane contact seals, special for underwater, that can support up to 4 bar of outer pressure
<b>PP5</b>	Obturaciones para trabajos a alta temperatura	Seals for high temperature work
<b>PP7</b>	Obturaciones de poliuretano para ambientes extremadamente húmedos y salinos, con protección adicional contra los rayos UV	TPU contact seals for extremely humid and salty environment. Added protection against UV rays
<b>ZZ</b>	Placas de protección de chapa de acero	Sheet steel shields
<b>CE03</b>	Pavonados	Black oxide coated
<b>CE04</b>	Fosfatados	Phosphate coated
<b>CE05</b>	Recubrimiento protector contra la corrosión	Anti corrosion coating
<b>ENH</b>	Rodamiento perteneciente a la línea $E^*$ Enhanced, cuyas cargas dinámicas corresponden a los valores de $Cr E^*$ . (Como referencia se muestran también, en las tablas de producto, los valores de $Cr$ calculados según la norma ISO 281)	$E^*$ Enhanced bearing series whose dynamic load rating corresponds to $Cr E^*$ values. (As reference, $Cr$ values calculated according to ISO 281 are shown in the product tables)

Tabla 3. Table 3



NOTAS / NOTES

---

---

---

---

---

---

---

---

---

---

---

---

---

---

---

---

---

---

---

---

---

---

---

---

---

---



## 2.4 Rodamientos de dos hileras completamente llenos de rodillos cilíndricos para poleas de cable

### Double row full complement cylindrical roller bearings for cable sheaves

## RODAMIENTOS FIJOS / LOCATING BEARINGS

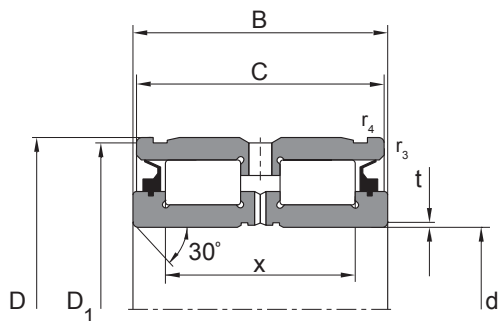

### NNF-PP-V

DIMENSIONES* BOUNDARY DIMENSIONS*				DESIGNACIÓN DESIGNATION	DESIGNACIÓN ALTERNATIVA ALTERNATIVE DESIGNATION	€ <sup>+</sup>	CAPACIDAD DE CARGA LOAD RATING (kN)			CARGA LIM. DE FATIGA / FATIGUE LIMIT LOAD (kN)	VEL. LIMITE SPEED RATINGS (rpm)
d	D	B	C				dyn. Cr	dyn. € <sup>+</sup> Cr € <sup>+</sup>	stat. Cor	Cu	ng grasa/grease
20	42	30	29	NNF5004-PP-V	SL04-5004-PP	€ <sup>+</sup>	41,4	43,8	51,6	6,3	3.700
25	47	30	29	NNF5005-PP-V	SL04-5005-PP	€ <sup>+</sup>	45	48	61,7	7,6	3.300
30	55	34	33	NNF5006-PP-V	SL04-5006-PP	€ <sup>+</sup>	52,4	55	72	8,8	2.800
35	62	36	35	NNF5007-PP-V	SL04-5007-PP	€ <sup>+</sup>	64,8	68	90	11	2.400
40	68	38	37	NNF5008-PP-V	SL04-5008-PP	€ <sup>+</sup>	80	83	115	14	2.200
45	75	40	39	NNF5009-PP-V	SL04-5009-PP	€ <sup>+</sup>	96	100	145	17,7	2.000
50	80	40	39	NNF5010-PP-V	SL04-5010-PP	€ <sup>+</sup>	102	106	155	19	1.800
55	90	46	45	NNF5011-PP-V	SL04-5011-PP	€ <sup>+</sup>	120	125	191	23,3	1.700
60	95	46	45	NNF5012-PP-V	SL04-5012-PP	€ <sup>+</sup>	125	130	206	26	1.500
65	100	46	45	NNF5013-PP-V	SL04-5013-PP	€ <sup>+</sup>	130	135	220	27	1.400
70	110	54	53	NNF5014-PP-V	SL04-5014-PP	€ <sup>+</sup>	190,5	200	278	37	1.300
75	115	54	53	NNF5015-PP-V	SL04-5015-PP	€ <sup>+</sup>	200	210	325	43	1.300
80	125	60	59	NNF5016-PP-V	SL04-5016-PP	€ <sup>+</sup>	221	230	400	48	1.200
85	130	60	59	NNF5017-PP-V	SL04-5017-PP	€ <sup>+</sup>	251	265	410	52	1.100
90	140	67	66	NNF5018-PP-V	SL04-5018-PP	€ <sup>+</sup>	305	315	535	69	1.000
95	145	67	66	NNF5019-PP-V	SL04-5019-PP	€ <sup>+</sup>	310	320	555	71	1.000
100	150	67	66	NNF5020-PP-V	SL04-5020-PP	€ <sup>+</sup>	318	332	560	71,5	900
110	170	80	79	NNF5022-PP-V	SL04-5022-PP	€ <sup>+</sup>	390	405	690	85	800
120	180	80	79	NNF5024-PP-V	SL04-5024-PP	€ <sup>+</sup>	405	420	745	91	800
130	190	80	79	NNF130-PP-V	SL04-130-PP	€ <sup>+</sup>	420	435	800	98	700
	200	95	94	NNF5026-PP-V	SL04-5026-PP	€ <sup>+</sup>	540	565	1.000	122	700
140	200	80	79	NNF140-PP-V	SL04-140-PP	€ <sup>+</sup>	435	450	850	104	700
	210	95	94	NNF5028-PP-V	SL04-5028-PP	€ <sup>+</sup>	605	630	1.100	135	650
150	210	80	79	NNF150-PP-V	SL04-150-PP	€ <sup>+</sup>	445	466	910	110	600
	225	100	99	NNF5030-PP-V	SL04-5030-PP	€ <sup>+</sup>	695	720	1.260	153	600
160	220	80	79	NNF160-PP-V	SL04-160-PP	€ <sup>+</sup>	470	490	970	115	600
	240	109	108	NNF5032-PP-V	SL04-5032-PP	€ <sup>+</sup>	725	750	1.380	160	570
170	230	80	79	NNF170-PP-V	SL04-170-PP	€ <sup>+</sup>	485	500	1.050	120	600
	260	122	121	NNF5034-PP-V	SL04-5034-PP	€ <sup>+</sup>	935	970	1.800	208	550
180	240	80	79	NNF180-PP-V	SL04-180-PP	€ <sup>+</sup>	495	510	1.100	125	500
	280	136	135	NNF5036-PP-V	SL04-5036-PP	€ <sup>+</sup>	1.090	1.150	2.130	250	500
190	260	80	79	NNF190-PP-V	SL04-190-PP	€ <sup>+</sup>	505	530	1.200	130	500

\*Dimensiones en mm. / \* Dimensions in mm.

\*\*Masa en kg. / \*\* Mass in kg.

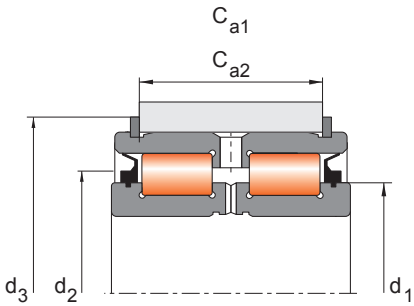

**NNF-PP-V**  
Mounting dimensions

$r_3, r_4$ (min)	DIMENSIONES SECUNDARIAS SECONDARY DIMENSIONS						MASA** MASS**	DIMENSIONES DE MONTAJE MOUNTING DIMENSIONS					ANILLOS DE RETENCIÓN RETAINING RINGS	
	$C_1$	$D_1$	$m$	$t_{min}$	$x$	<sup>1)</sup> $C_{a1}$		<sup>2)</sup> $C_{a2}$	$d_1$	$d_2$	$d_3$	WRE	DIN471	
0,3	24,7	40,2	1,8	0,5	22,5	0,21	21,5	21	30,55	34	47	WRE42	42x1,75	
0,3	24,7	45,2	1,8	0,5	22,5	0,24	21,5	21	35,35	39	52	WRE47	47x1,75	
0,3	28,2	53	2,1	0,5	25,5	0,37	25	24	40,6	44	60	WRE55	55x2	
0,3	30,2	60	2,1	0,5	27,5	0,47	27	26	46,1	50	67	WRE62	62x2	
0,6	32,2	65,8	2,7	0,8	28,5	0,55	28	27	51,4	55	75	WRE68	68x2,5	
0,6	34,2	72,8	2,7	0,8	30,5	0,7	30	29	57	61	82	WRE75	75x2,5	
0,6	34,2	77,8	2,7	0,8	30,5	0,75	30	29	61,8	66	87	WRE80	80x2,5	
0,6	40,2	87,4	3,2	1	36	1,2	35	34	68,6	73	99	WRE90	90x3	
0,6	40,2	92,4	3,2	1	36	1,25	35	34	73,7	79	104	WRE95	95x3	
0,6	40,2	97,4	3,2	1	36	1,3	35	34	78,8	84	109	WRE100	100x3	
0,6	48,2	107,1	4,2	1	42	1,85	43	40	84,5	91	119	WRE110	110x4	
0,6	48,2	112,1	4,2	1	42	2	43	40	89,95	97	124	WRE115	115x4	
0,6	54,2	122,1	4,2	1,5	48	2,7	49	46	97,1	105	137	WRE125	125x4	
0,6	54,2	127,1	4,2	1,5	48	2,8	49	46	103,9	112	142	WRE130	130x4	
0,6	59,2	137	4,2	1,5	54	3,75	54	51	109,3	118	152	WRE140	140x4	
0,6	59,2	142	4,2	1,5	54	3,9	54	51	113,35	122	157	WRE145	145x4	
0,6	59,2	147	4,2	1,5	54	4	54	51	117,35	128	162	WRE150	150x4	
0,6	70,2	167	4,2	1,8	64	6,5	65	62	131,55	143	182	WRE170	170x4	
0,6	71,2	176	4,2	1,8	64	7	65	63	140,9	153	196	WRE180	180x4	
0,6	71,2	186	4,2	1,8	64	7,5	65	63	150,55	160	206	WRE190	190x4	
0,6	83,2	196	4,2	1,8	77	10,5	77	75	156,75	170	216	WRE200	200x4	
0,6	71,2	196	4,2	1,8	64	8	65	63	159,95	170	216	WRE200	200x4	
0,6	83,2	206	5,2	1,8	77	11	77	73	165,4	181	226	WRE210	210x5	
0,6	71,2	206	5,2	1,8	64	8,4	65	61	174,4	185	226	WRE210	210x5	
0,6	87,2	221	5,2	2	80	13,5	81	77	175,7	192	245	WRE225	225x5	
0,6	71,2	216	5,2	1,8	64	8,8	65	61	184,05	196	236	WRE220	220x5	
0,6	95,2	236	5,2	2	89	16,5	89	85	189	207	260	WRE240	240x5	
0,6	71,2	226	5,2	1,8	64	9,3	65	61	193,9	206	250	WRE230	230x5	
0,6	107,2	254	5,2	2	100	22,5	99	97	200,7	220	282	WRE260	260x5	
0,6	71,2	236	5,2	1,8	64	9,8	65	61	203,1	216	260	WRE240	240x5	
0,6	118,2	274	5,2	2	112	30	110	108	217,8	239	302	WRE280	280x5	
0,6	73,2	254	5,2	1,8	64	12,7	65	63	217,55	231	282	WRE260	260x5	

<sup>1)</sup> Para anillo elástico WRE / For snap ring WRE

<sup>2)</sup> Para anillo elástico de seguridad según DIN 471 / For retaining ring to DIN 471

\*Dimensiones en mm. / \* Dimensions in mm.

\*\*Masa en kg. / \*\* Mass in kg.

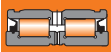

2.4 Rodamientos de dos hileras completamente llenos de rodillos cilíndricos para poleas de cable  
*Double row full complement cylindrical roller bearings for cable sheaves*

RODAMIENTOS FIJOS / LOCATING BEARINGS

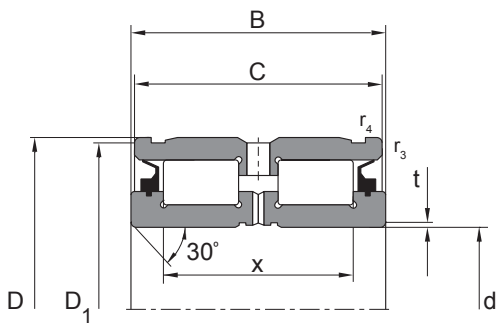

NNF-PP-V

DIMENSIONES* BOUNDARY DIMENSIONS*				DESIGNACIÓN DESIGNATION	DESIGNACIÓN ALTERNATIVA ALTERNATIVE DESIGNATION	E*	CAPACIDAD DE CARGA LOAD RATING (kN)			CARGA LIM. DE FATIGA / FATIGUE LIMIT LOAD (kN) Cu	VEL. LIMITE SPEED RATINGS (rpm) ng grasa/grease
d	D	B	C				dyn. Cr	dyn. E* Cr E*	stat. Cor		
190	290	136	135	NNF5038-PP-V	SL04-5038-PP	E*	1.130	1.180	2.200	256	500
200	270	80	79	NNF200-PP-V	SL04-200-PP	E*	525	545	1.250	135	500
	310	150	149	NNF5040-PP-V	SL04-5040-PP	E*	1.310	1.370	2.670	300	450
220	300	95	94	NNF220-PP-V	SL04-220-PP	E*	685	720	1.600	175	450
	340	160	159	NNF5044-PP-V	SL04-5044-PP	E*	1.500	1.570	3.100	350	450
240	320	95	94	NNF240-PP-V	SL04-240-PP	E*	710	750	1.720	185	450
	360	160	159	NNF5048-PP-V	SL04-5048-PP	E*	1.580	1.640	3.350	370	400
260	340	95	94	NNF260-PP-V	SL04-260-PP	E*	760	800	1.940	210	400
	400	190	189	NNF5052-PP-V	SL04-5052-PP	E*	2.285	2.370	4.740	515	400
280	360	95	94	NNF280-PP-V	SL04-280-PP	E*	790	820	2.050	220	350
	420	190	189	NNF5056-PP-V	SL04-5056-PP	E*	2.500	2.600	5.240	564	350
300	380	95	94	NNF300-PP-V	SL04-300-PP	E*	815	850	2.160	230	350
	460	218	216	NNF5060-PP-V	SL04-5060-PP	E*	2.860	3.000	5.800	620	300

\*Dimensiones en mm. / \* Dimensions in mm.  
 \*\*Masa en kg. / \*\* Mass in kg.

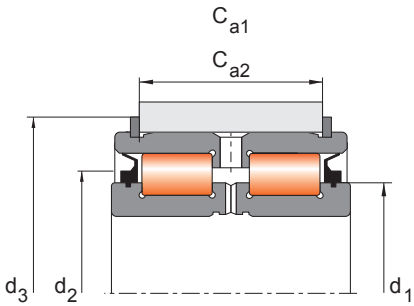

**NNF-PP-V**  
Mounting dimensions

$r_3, r_4$ (min)	DIMENSIONES SECUNDARIAS SECONDARY DIMENSIONS						MASA** MASS**	DIMENSIONES DE MONTAJE MOUNTING DIMENSIONS					ANILLOS DE RETENCIÓN RETAINING RINGS	
	$C_1$	$D_1$	$m$	$t_{min}$	$x$	<sup>1)</sup> $C_{a1}$		<sup>2)</sup> $C_{a2}$	$d_1$	$d_2$	$d_3$	WRE	DIN471	
0,6	118,2	284	5,2	2	112	31,5	110	108	225,65	248	312	WRE290	290x5	
0,6	73,2	264	5,2	1,8	64	13	65	63	227,15	241	292	WRE270	270x5	
0,6	128,2	304	6,3	2	126	41	120	116	243,05	267	336	WRE310	310x6	
1	83,2	294	5,2	2	72	20	75	73	248,7	264	322	WRE300	300x5	
1	138,2	334	6,3	2	132	53	130	126	259,85	286	366	WRE340	340x6	
1	83,2	314	6,3	2	72	21	75	71	271,7	287	346	WRE320	320x6	
1	138,2	354	6,3	2	132	56,5	130	126	279,25	305	386	WRE360	360x6	
1	83,2	334	6,3	3	75	23	75	71	292,7	310	366	WRE340	340x6	
1,1	162,2	394	6,3	3	150	85	154	150	304,95	336	426	WRE400	400x6	
1	83,2	354	6,3	3	75	24	75	71	312	330	386	WRE360	360x6	
1,1	163,2	413	7,3	3	150	90	154	149	320,95	354	453	WRE420	420x7	
1	83,2	374	6,3	3	75	26	75	71	328	346	406	WRE380	380x6	
1,1	185,2	453	7,3	3	170	127	176	171	346,85	375	493	WRE460	460x7	

<sup>1)</sup> Para anillo elástico WRE / For snap ring WRE

<sup>2)</sup> Para anillo elástico de seguridad según DIN 471 / For retaining ring to DIN 471

\*Dimensiones en mm. / \* Dimensions in mm.

\*\*Masa en kg. / \*\* Mass in kg.



# 2.5



Rodamientos de rodillos cilíndricos  
de cuatro y seis hileras  
*Four and six row cylindrical roller bearings*



## 2.5 Rodamientos de rodillos cilíndricos de cuatro y seis hileras Four and six row *cylindrical roller bearings*

índice

Características técnicas .....	146
Rodamientos de rodillos cilíndricos de cuatro hileras .....	146
Rodamientos de rodillos cilíndricos de seis hileras .....	147
Dimensiones .....	147
Tolerancias .....	148
Juego radial interno .....	148
Carga mínima .....	148
Carga dinámica equivalente.....	151
Carga estática equivalente .....	151
Montaje .....	151
Tabla de dimensiones .....	152

index

Technical characteristics .....	146
Four row cylindrical roller bearings .....	146
Six row cylindrical roller bearings .....	147
Dimensions .....	147
Tolerances .....	148
Internal radial clearance .....	148
Minimum load .....	148
Equivalent dynamic bearing load .....	151
Equivalent static bearing load.....	151
Mounting .....	151
Dimensions table .....	152

### NBI E<sup>+</sup> - SERIES CON SUPERIORES CAPACIDADES DE CARGA



NBI ha combinado los últimos avances en investigación de materiales y en metalurgia con su experiencia en diseño y fabricación de rodamientos para crear una nueva línea de rodamientos de rodillos cilíndricos con excepcionales prestaciones.

La mejora en la rugosidad de las pistas de rodadura y la optimización de los perfiles de las mismas, junto con el empleo de rodillos de un grado de precisión superior minimizan el rozamiento y optimizan la distribución de la carga. La circulación del lubricante también se favorece con un nuevo diseño de los flancos de guiado de los rodillos en las pistas.

La capacidad de aceptar desalineamientos y la capacidad de carga axial han aumentado como consecuencia de estas mejoras. Para todas las cuestiones acerca de las series NBI E<sup>+</sup>, consulte con nuestro departamento de ingeniería.

### NBI E<sup>+</sup> - SERIES WITH ENHANCED LOAD RATING CHARACTERISTICS

NBI has combined the latest achievements of metallurgy and material research with its expertise in bearing design and manufacturing to create a new line of cylindrical roller bearings with additional benefits.

Improvements in internal design features optimize the internal load distribution. Lubricant flow is enhanced by newly defined geometry of the bearings functional surfaces.

The ability to accept misalignments plus the axial load carrying capacity have increased due to these improvements. This technical progress allows for working with higher dynamic load ratings. For all questions you may have regarding the NBI E<sup>+</sup> series, please feel free to contact our engineering team.



4 HILERAS / 4 ROWS



6 HILERAS / 6 ROWS



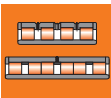

## RODAMIENTOS DE RODILLOS CILÍNDRICOS DE CUATRO Y SEIS HILERAS

### Características técnicas

Los rodamientos de rodillos en múltiples hileras son usados en aplicaciones donde es necesario una gran capacidad de carga radial, principalmente en laminadores de rodillos, prensas de rodillos y calandras.

Estos rodamientos son diseñados para aceptar solo grandes cargas radiales. Por lo tanto cualquier carga axial tiene que ser soportada por un rodamiento fijo separado.

Los rodamientos cilíndricos de múltiples hileras están disponibles en diferentes diseños básicos, en varios materiales y diferentes variantes de diseño. Los rodamientos están optimizados para trabajar a grandes velocidades como es típico en aplicaciones de rodillos laminadores y calandras.

Debido a la amplia gama de diseños diferentes disponibles, todos los rodamientos de rodillos de múltiples hileras son producidos solo bajo pedido de cliente.

### Rodamientos de rodillos cilíndricos de cuatro hileras

Los rodamientos de rodillos cilíndricos de cuatro hileras son diseñados para trabajar con cargas pesadas y altas velocidades, como por ejemplo los cilindros de laminación. NBI ofrece una amplia variedad de diferentes diseños.

Los rodamientos de rodillos cilíndricos de cuatro hileras están disponibles en una variedad de diseños diferentes para satisfacer las necesidades individuales de las diferentes aplicaciones. Dependiendo de los diseños individuales esos roda-

## FOUR AND SIX ROW CYLINDRICAL ROLLER BEARINGS

### Technical characteristics

Multi row cylindrical roller bearings are being used in applications where a high radial load capacity is required, chiefly in rolling mill stands, roller presses and calendars.

These bearings are designed for accepting high radial loads only. Hence, any axial load must be accommodated by a separate locating bearing.

NBI multi row cylindrical roller bearings are available in different basic layouts and various material and design variants. The bearings are being optimized for working at high speeds which is typical for calendar and rolling mill applications.

Due to the wide range of different designs available, all NBI multi row bearings are being produced to customer's orders only.

### Four row cylindrical roller bearings

NBI four row cylindrical roller bearings are being designed for working at heavy loads and high speeds, i.e. in rolling mill stands. NBI offers a wide variety of different designs.

NBI four row cylindrical roller bearings are available in a variety of different designs for meeting the individual requirements of different applications. Depending on the individual designs, these bearings may feature following technical characteristics:

mientos pueden presentar unas propiedades técnicas características:

- Agujeros de lubricación en las caras laterales del aro interior o del aro exterior
- Ranura helicoidal en el diámetro del aro interior
- Ranura circunferencial y agujeros de lubricación en el aro exterior
- Diámetro interior cónico
- Rodillos y aros templados
- Rodillos y aros con temple bainítico
- Obturaciones en uno o ambos lados

### Rodamientos de rodillos cilíndricos de seis hileras

Los rodamientos de rodillos cilíndricos de seis hileras son principalmente utilizados en pequeños cilindros de laminación en frío para producto plano donde se dan grandes fuerzas y altas velocidades.

Los rodamientos tienen un aro exterior con dos flancos libres y tres anillos de guiado separables, entre los que van guiados seis hileras de rodillos.

Tres jaulas mecanizadas de latón con espigas dobles.

El aro interior sin pestañas permite un limitado desplazamiento axial del cuello del cilindro con respecto a la ampuesa.

### Dimensiones

Las dimensiones de los rodamientos de rodillos cilíndricos de cuatro hileras no están sujetas a la normativa internacional.

Los rodamientos de rodillos cilíndricos de cuatro hileras NBI son totalmente intercambiables con productos de otros fabricantes de rodamientos.

- Oil grooves in the side faces of inner and/or outer ring
- Helical groove in the bearing bore diameter
- Circumferential groove and lubrication holes in the outer ring
- Tapered bore
- Case hardened rings and / or rollers
- Bainitic hardened rings and / or rollers
- Seals on one or both sides

### Six row cylindrical roller bearings

Six row cylindrical roller bearings are primarily used in small cold rolling mills for flat products where high forces and high speeds occur.

The bearings have an outer ring with two loose flanges and three loose guiding rings, between which the six roller rows are guided.

Three double pronged machine brass cages retain the rollers.

The inner ring without flanges allow for limited axial displacements of the roll neck within the bearing.

### Dimensions

The boundary dimensions of four row cylindrical roller bearings are not subjected to international standards. NBI four row cylindrical roller bearings are being fully interchangeable with the products of other bearing manufacturers.

The dimensions of the six-row cylindrical roller

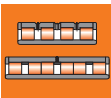

## 2.5 Rodamientos de rodillos cilíndricos de cuatro y seis hileras Four and six row *cylindrical roller bearings*

Las dimensiones de los rodamientos de rodillos cilíndricos de seis hileras cumplen con la normativa ISO 15:1998.

### Tolerancias

Los rodamientos de rodillos cilíndricos de cuatro hileras se fabrican con el estándar de precisión NBI, que se emplea en los rodamientos de los cuellos de cilindros, es decir, una precisión dimensional según la clase de tolerancia P6 y una precisión de funcionamiento según la clase de tolerancia P5 como estándar.

Los rodamientos de rodillos cilíndricos de seis hileras se fabrican con una tolerancia normal (PN) como estándar.

### Juego radial interno

Los rodamientos de rodillos cilíndricos de cuatro hileras se fabrican normalmente con un juego radial de C3 o C4 requerido para los rodamientos de rodillos de laminación. Los rodamientos a montar con un ajuste flojo sobre los cuellos de los cilindros suelen tener un juego radial interno C2.

Los rodamientos de rodillos cilíndricos de seis hileras NBI se fabrican con el juego radial interno especificado en el pedido.

Los valores correspondientes al juego, en caso de estar normalizados, cumplen con la ISO 5753:1991 y se muestran en la tabla 1 para los rodamientos con agujero cilíndrico y en la tabla 2 para los rodamientos con agujero cónico.

### Carga mínima

Los rodamientos en general requieren una carga mínima radial para evitar la fricción por deslizamiento. En el caso de los rodamientos de rodillos cilíndricos se requiere una carga radial mínima del 4% de la capacidad de carga dinámica Cr.

bearings of series NNU 69 and NNU 60 are in accordance with ISO 15:1998.

### Tolerances

NBI four row cylindrical roller bearings are being produced with the NBI standard accuracy for rolling neck bearings, i.e. featuring P6 dimensional accuracy and a P5 inner ring running accuracy as standard.

NBI six row cylindrical roller bearings are standard manufactured to normal tolerance class, PN.

### Internal radial clearance

NBI four row cylindrical roller bearings are normally produced with C3 or C4 radial internal clearance required for rolling mill bearings. Bearings for mounting with a loose fit on the roll necks generally have C2 radial internal clearance.

NBI six row cylindrical roller bearings are produced with the radial internal clearance specified by customer order.

The clearance values, where standardized, conform to DIN620-4 and ISO 5753:1991 and are given in the tables of radial cylindrical roller bearings.

### Minimum load

Rolling element bearings require a minimum radial load to avoid sliding friction. Particularly cylindrical roller bearings require a minimum radial load of more than 4% of the dynamic load rating Cr.

Juego radial interno en  $\mu\text{m}$  de los rodamientos de rodillos cilíndricos de cuatro y seis hileras **NBI** con eje cilíndrico  
*Internal clearance in  $\mu\text{m}$  of **NBI** four and six row cylindrical roller bearings with cylindrical bore*

Juego radial Clearance group	Diámetro de eje / Bore diameter (mm)														
	>	-	24	30	40	50	65	80	100	120	140	160	180	200	225
	≤	24	30	40	50	65	80	100	120	140	160	180	200	225	250
C1	min	5	5	5	5	5	10	10	10	10	10	10	15	15	15
	max	15	15	15	18	20	25	30	30	35	35	40	45	50	50
C2	min	0	0	5	5	10	10	15	15	15	20	25	35	45	45
	max	25	25	30	35	40	45	50	55	60	70	75	90	105	110
CN	min	20	20	25	30	40	40	50	50	60	70	75	90	105	110
	max	45	45	50	60	70	75	85	90	105	120	125	145	165	175
C3	min	35	35	45	50	60	65	75	85	100	115	120	140	160	170
	max	60	60	70	80	90	100	110	125	145	165	170	195	220	235
C4	min	50	50	60	70	80	90	105	125	145	165	170	195	220	235
	max	75	75	85	100	110	125	140	165	190	215	220	250	280	300
C5	min	75	75	85	100	110	125	140	165	190	215	220	250	280	300
	max	100	100	110	130	140	160	175	205	235	265	270	305	340	365

Juego radial Clearance group	Diámetro de eje / Bore diameter (mm)														
	>	250	280	315	355	400	450	500	560	630	710	800	900	1.000	1.120
	≤	280	315	355	400	450	500	560	630	710	800	900	1.000	1.120	1.250
C1	min	20	20	20	25	25	25	25	30	30	35	35	35	50	230
	max	55	60	65	75	85	95	100	110	130	140	160	180	200	470
C2	min	55	55	65	100	110	110	120	140	145	150	180	200	220	230
	max	125	130	145	190	210	220	240	260	285	310	350	390	430	470
CN	min	125	130	145	190	210	220	240	260	285	310	350	390	430	470
	max	195	205	225	280	310	330	360	380	425	470	520	580	640	710
C3	min	190	200	225	280	310	330	360	380	425	470	520	580	640	710
	max	260	275	305	370	410	440	480	500	565	630	690	770	850	950
C4	min	260	275	305	370	410	440	480	500	565	630	690	770	850	950
	max	330	350	385	460	510	550	600	620	705	790	860	960	1.060	1.190
C5	min	330	350	385	460	510	550	600	620	705	790	860	960	1.060	1.510
	max	400	425	465	550	610	660	720	740	845	950	1.030	1.150	1.270	1.750

Tabla 1. Table 1

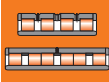

## 2.5 Rodamientos de rodillos cilíndricos de cuatro y seis hileras Four and six row cylindrical roller bearings

Juego radial interno en  $\mu\text{m}$  de los rodamientos de rodillos cilíndricos de cuatro y seis hileras **NBI con eje cónico**  
*Internal clearance in  $\mu\text{m}$  of **NBI** four and six row cylindrical roller bearings with tapered bore*

Juego radial Clearance group	Diámetro de eje / Bore diameter (mm)														
	>	-	24	30	40	50	65	80	100	120	140	160	180	200	225
	≤	24	30	40	50	65	80	100	120	140	160	180	200	225	250
C1	min	10	15	15	17	20	25	35	40	45	50	55	60	60	65
	max	20	25	25	30	35	40	55	60	70	75	85	90	95	100
C2	min	15	20	20	25	30	35	40	50	55	60	75	85	95	105
	max	40	45	45	55	60	70	75	90	100	110	125	140	155	170
CN	min	30	35	40	45	50	60	70	90	100	110	125	140	155	170
	max	55	60	65	75	80	95	105	130	145	160	175	195	215	235
C3	min	40	45	55	60	70	85	95	115	130	145	160	180	200	220
	max	65	70	80	90	100	120	130	155	175	195	210	235	260	285
C4	min	50	55	70	75	90	110	120	140	160	180	195	220	245	270
	max	75	80	95	105	120	145	155	180	205	230	245	275	305	335
C5	min	75	80	95	105	120	145	155	180	205	230	245	275	305	335
	max	100	105	120	135	150	180	190	220	250	280	295	330	365	400

Juego radial Clearance group	Diámetro de eje / Bore diameter (mm)														
	>	250	280	315	355	400	450	500	560	630	710	800	900	1.000	1.120
	≤	280	315	355	400	450	500	560	630	710	800	900	1.000	1.120	1.250
C1	min	75	80	90	100	110	120	130	140	160	170	190	210	230	-
	max	110	120	135	150	170	190	210	230	260	290	330	360	400	-
C2	min	115	130	145	165	185	205	230	260	295	325	370	410	455	490
	max	185	205	225	255	285	315	350	380	435	485	540	600	665	730
CN	min	185	205	225	255	285	315	350	380	435	485	540	600	665	730
	max	255	280	305	345	385	425	470	500	575	645	710	790	875	970
C3	min	240	265	290	330	370	410	455	500	565	630	700	780	865	960
	max	310	340	370	420	470	520	575	620	705	790	870	970	1075	1.200
C4	min	295	325	355	405	455	505	560	620	695	775	860	960	1065	1.200
	max	365	400	435	495	555	615	680	740	835	935	1.030	1.150	1.275	1.440
C5	min	365	400	435	495	555	615	680	740	835	935	1.030	1.150	1.275	-
	max	435	475	515	585	655	725	800	860	975	1.095	1.200	1.340	1.485	-

Tabla 2. Table 2

### Carga dinámica equivalente

$$P = F_r$$

### Carga estática equivalente

$$P_o = F_r$$

### Montaje de rodamientos de cuatro y seis hileras de rodillos cilíndricos

Cuando se manipula o se montan rodamientos de rodillos cilíndricos de múltiples hileras es necesario aplicar un particular cuidado combinado con el conocimiento y la experiencia.

En los rodamientos de rodillos cilíndricos de múltiples hileras de NBI todos los componentes individuales se marcan con el mismo número consecutivo para que no haya riesgo de mezclar componentes en caso de error. Los componentes individuales del rodamiento están marcados con letras para su identificación.

Los componentes individuales del rodamiento tienen que ser montados en su correcto orden. Como los componentes individuales de todos los rodamientos de rodillos cilíndricos de múltiples hileras NBI están cuidadosamente emparejados, un intercambio de los componentes, incluso entre los rodamientos del mismo tipo debe ser estrictamente evitado.

### Equivalent dynamic bearing load

$$P = F_r$$

### Equivalent static bearing load

$$P_o = F_r$$

### Mounting of four and six row NBI cylindrical roller bearings

A particular care combined with knowledge and experience must be applied when handling and mounting multi row cylindrical roller bearings.

In NBI multi row cylindrical roller bearings, all components of each individual bearing are marked with the same consecutive number to prevent the parts of different bearings from getting mixed up in error. The individual components of a bearing are marked with letters for identification.

The individual components of each bearing must be mounted in correct sequence. As the individual parts of every NBI multi row bearings are being carefully matched, an interchange of components even between bearings of the same type must be strictly avoided.

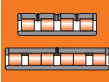

## 2.5 Rodamientos de rodillos cilíndricos de cuatro y seis hileras Four and six row cylindrical roller bearings

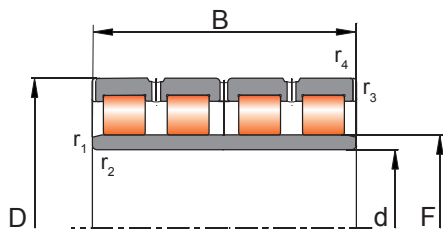

**DESIGN A**  
With solid brass cage

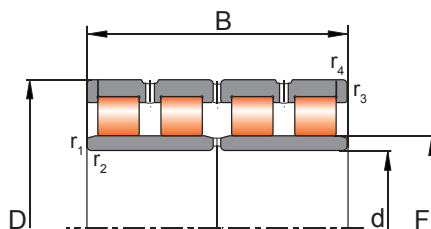

**DESIGN B**  
With solid brass cage

DIMENSIONES* BOUNDARY DIMENSIONS*			DESIGNACION DESIGNATION	DISEÑO DESIGN	E <sup>+</sup>	CAPACIDAD DE CARGA (kN) LOAD RATING (kN)			CARGA LIMITE DE FATIGA (kN) FATIGUE LIMIT LOAD (kN)	
d	D	B				dyn. Cr	dyn. E <sup>+</sup> Cr E <sup>+</sup>	stat. Cor	Cu	
120	180	92	FR30092-A	A	E <sup>+</sup>	390	407	820	80	
	180	105	FR300105-A	A	E <sup>+</sup>	430	454	927	93	
130	200	104	FR330104-A	A	E <sup>+</sup>	450	478	1.005	103	
140	190	119	FR330119-A	A	E <sup>+</sup>	470	500	1.106	115	
145	210	155	FR355155-A	A	E <sup>+</sup>	620	654	1.656	182	
	225	156	FR370156-A	A	E <sup>+</sup>	790	828	1.802	199	
150	220	150	FR370150-A	A	E <sup>+</sup>	660	701	1.700	187	
	230	130	FR380130-A	A	E <sup>+</sup>	640	670	955	96	
	230	156	FR380156-A	A	E <sup>+</sup>	790	825	1.710	188	
160	220	180	FR380180-A	A	E <sup>+</sup>	880	920	2.490	284	
	230	130	FR390130-A	A	E <sup>+</sup>	740	781	1.340	143	
	230	168	FR390168-A	A	E <sup>+</sup>	860	895	2.170	245	
	240	170	FR400170-A	A	E <sup>+</sup>	940	980	2.290	259	
170	230	120	FR400120-A	A	E <sup>+</sup>	580	615	1.580	173	
	230	130	FR400130-A	A	E <sup>+</sup>	640	670	1.400	151	
	240	130	FR410130-A	A	E <sup>+</sup>	870	910	1.800	199	
	240	156	FR410156-A	A	E <sup>+</sup>	860	900	2.170	245	
	250	168	FR420168-A	A	E <sup>+</sup>	990	1.040	2.320	262	
	255	180	FR425180-A	A	E <sup>+</sup>	1.050	1.120	2.460	280	
180	260	225	FR430225-A	A	E <sup>+</sup>	1.500	1.620	3.300	382	
	250	156	FR430156-A	A	E <sup>+</sup>	800	880	2.230	252	
	260	168	FR440168-A	A	E <sup>+</sup>	980	1.050	2.300	260	
190	280	180	FR460180-A	A	E <sup>+</sup>	1.200	1.287	2.900	334	
	260	168	FR450168-A	A	E <sup>+</sup>	1.080	1.140	2.600	277	
	270	170	FR460170-A	A	E <sup>+</sup>	1.080	1.150	2.700	289	
200	270	200	FR460200-A	A	E <sup>+</sup>	1.400	1.500	3.300	360	
	280	200	FR470200-A	A	E <sup>+</sup>	1.600	1.680	3.350	365	
	270	170	FR470170-A	A	E <sup>+</sup>	1.100	1.170	2.580	275	
	280	200	FR480200-A	A	E <sup>+</sup>	1.400	1.500	3.310	363	
	290	192	FR490192-A	A	E <sup>+</sup>	1.450	1.540	3.310	353	
310	200		FR510200-A	A	E <sup>+</sup>	1.500	1.573	3.600	389	
	230		FR510230-A	A	E <sup>+</sup>	1.900	1.960	3.690	400	

\*Dimensiones en mm. / \* Dimensions in mm.

\*\*Masa en kg. / \*\* Mass in kg.



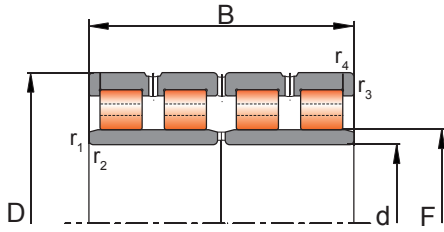

**DESIGN C**  
With pin cage

DESIGNACION DESIGNATION	$r_1, r_2$ (min)	$r_3, r_4$ (min)	DIMENSIONES SECUNDARIAS SECONDARY DIMENSIONS		MASA** MASS**
			F		
FR30092-A	2	2		137	8,4
FR300105-A	2,5	2,5		135	9,6
FR330104-A	2,5	2,5		150	12,5
FR330119-A	1,5	1,5		154	9,9
FR355155-A	1,1	1,1		166	18,9
FR370156-A	2	2		169	24,1
FR370150-A	2,5	2,5		168	19,3
FR380130-A	2,5	2,5		174	19,7
FR380156-A	2	2		174	24
FR380180-A	2,5	2,5		177	20,2
FR390130-A	1,5	1,5		180	17
FR390168-A	2	2		179	23,5
FR400170-A	2	2,5		183	27,8
FR400120-A	2,5	2,5		187	14,3
FR400130-A	2	2		188,5	15,3
FR410130-A	2	2		190	18,7
FR410156-A	2,5	2,5		189	22,2
FR420168-A	2,5	2,5		192	28
FR425180-A	2,5	2,5		193	30,5
FR430225-A	2,1	2,1		196	43,3
FR430156-A	2,5	2,5		200	22,8
FR440168-A	2,1	2,1		202	29,5
FR460180-A	2,1	2,1		206	40
FR450168-A	2	2		212	27
FR460170-A	2,5	2,5		213	31,7
FR460200-A	2,1	2,1		212	37,5
FR470200-A	2,1	2,1		214	41,5
FR470170-A	2,1	2,1		222	28,5
FR480200-A	0,6	2,1		222	39
FR490192-A	2,1	2,1		226	42,5
FR510200-A	2,1	2,1		229	55,8
FR510230-A	2,1	2,1		229	64

\*Dimensiones en mm. / \* Dimensions in mm.  
\*\*Masa en kg. / \*\* Mass in kg.

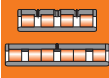

## 2.5 Rodamientos de rodillos cilíndricos de cuatro y seis hileras Four and six row cylindrical roller bearings

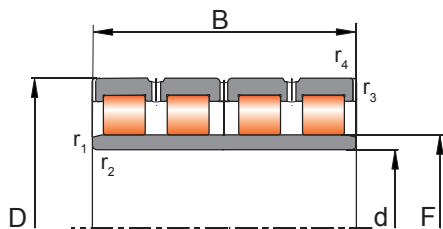

**DESIGN A**  
With solid brass cage

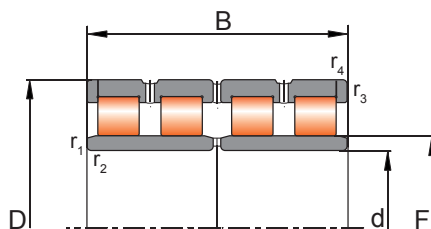

**DESIGN B**  
With solid brass cage

DIMENSIONES* BOUNDARY DIMENSIONS*			DESIGNACION DESIGNATION	DISEÑO DESIGN	E <sup>+</sup>	CAPACIDAD DE CARGA (kN) LOAD RATING (kN)			CARGA LIMITE DE FATIGA (kN) FATIGUE LIMIT LOAD (kN)	
d	D	B				dyn. Cr	dyn. E <sup>+</sup> Cr E <sup>+</sup>	stat. Cor	Cu	
210	290	192	FR500192-A	A	E <sup>+</sup>	1.370	1.450	3.400	364	
220	290	192	FR510192-A	A	E <sup>+</sup>	1.140	1.200	3.300	352	
	300	160	FR520160-A	A	E <sup>+</sup>	950	1.000	2.550	261	
	300	200	FR520200-A	A	E <sup>+</sup>	1.660	1.750	3.900	410	
	310	192	FR530192-A	A	E <sup>+</sup>	1.550	1.650	3.600	380	
	310	204	FR530204-B	B	E <sup>+</sup>	1.320	1.400	3.700	400	
	310	215	FR530215-B	B	E <sup>+</sup>	1.480	1.550	3.700	400	
	310	225	FR530225-A	A	E <sup>+</sup>	1.800	1.900	4.250	450	
	310	245	FR530245-B	B	E <sup>+</sup>	1.600	1.690	4.700	508	
	320	160	FR540160-A	A	E <sup>+</sup>	1.100	1.200	2.550	255	
	320	210	FR540210-B	B	E <sup>+</sup>	1.700	1.820	3.600	380	
	330	230	FR550230-B	B	E <sup>+</sup>	2.000	2.100	4.000	410	
	340	290	FR560290-B	B	E <sup>+</sup>	2.900	2.980	5.000	560	
230	330	206	FR560206-A	A	E <sup>+</sup>	1.800	1.900	4.000	435	
	340	260	FR570260-B	B	E <sup>+</sup>	1.900	2.000	5.050	570	
	365	250	FR595250-B	B	E <sup>+</sup>	2.500	2.650	4.900	540	
240	330	180	FR570180-A	A	E <sup>+</sup>	1.640	1.750	3.800	413	
	330	220	FR570220-A	A	E <sup>+</sup>	1.650	1.770	4.300	465	
	360	220	FR600220-B	B	E <sup>+</sup>	1.700	1.800	4.200	452	
250	350	220	FR600220-A	A	E <sup>+</sup>	1.600	1.700	4.350	460	
260	360	204	FR620204-A	A	E <sup>+</sup>	1.900	2.000	4.350	460	
	360	230	FR620230-A	A	E <sup>+</sup>	1.900	2.000	4.650	500	
	360	260	FR620260-B	B	E <sup>+</sup>	2.200	2.300	5.320	580	
	370	220	FR630220-A	A	E <sup>+</sup>	2.100	2.200	4.500	470	
	380	280	FR640280-A	A	E <sup>+</sup>	2.300	2.400	6.200	610	
	400	290	FR660290-B	B	E <sup>+</sup>	3.500	3.700	6.900	690	
265	370	234	FR635234-B	B	E <sup>+</sup>	2.200	2.300	5.250	520	
280	380	170	FR660170-A	A	E <sup>+</sup>	1.600	1.710	3.590	390	
	380	290	FR660290-B	B	E <sup>+</sup>	2.500	2.700	7.000	660	
	390	220	FR670220-A	A	E <sup>+</sup>	2.200	2.300	4.600	460	
	390	275	FR670275-B	B	E <sup>+</sup>	2.900	3.100	6.900	700	
	400	285	FR680285-B	B	E <sup>+</sup>	3.000	3.150	7.300	720	

\*Dimensiones en mm. / \* Dimensions in mm.

\*\*Masa en kg. / \*\* Mass in kg.

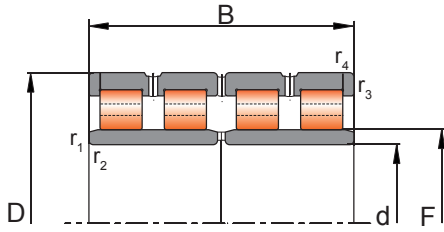

**DESIGN C**  
With pin cage

DESIGNACION DESIGNATION	$r_1, r_2$ (min)		$r_3, r_4$ (min)		DIMENSIONES SECUNDARIAS SECONDARY DIMENSIONS F	MASA** MASS*
	FR500192-A	2,1	2,1	2,1		
FR510192-A	2,5	2,5	2,5	2,5	239	33,8
FR520160-A	2,5	2,5	2,5	2,5	245	33
FR520200-A	2,1	2,1	2,1	2,1	240	41
FR530192-A	2,1	2,1	2,1	2,1	246	46
FR530204-B	2,5	2,5	2,5	2,5	247	50
FR530215-B	2,5	2,5	2,5	2,5	242	51,5
FR530225-A	0,6	2,1	2,1	2,1	244	54,5
FR530245-B	2,5	2,5	2,5	2,5	245	63,5
FR540160-A	3	3	3	3	245	46,5
FR540210-B	2,1	2,1	2,1	2,1	246	60
FR550230-B	3	3	3	3	249	68
FR560290-B	3	3	3	3	250	96
FR560206-A	2	2	2	2	260	58
FR570260-B	2,5	2,5	2,5	2,5	261	81
FR595250-B	3	3	3	3	266	100
FR570180-A	2,1	2,1	2,1	2,1	265	49,5
FR570220-A	2	2	2	2	270	57,5
FR600220-B	2,5	2,5	2,5	2,5	274	79,6
FR600220-A	3	3	3	3	278	65
FR620204-A	2,1	2,1	2,1	2,1	287	64,5
FR620230-A	3	3	3	3	292	73
FR620260-B	3	3	3	3	287	80
FR630220-A	3	3	3	3	292	76,5
FR640280-A	3	3	3	3	294	108
FR660290-B	4	4	4	4	296	135
FR635234-B	2,1	2,1	2,1	2,1	300	80
FR660170-A	3	3	3	3	306	55
FR660290-B	7x20°	2,1	2,1	2,1	308,5	75
FR670220-A	3	3	3	3	312	81,5
FR670275-B	3	2	2	2	308	101
FR680285-B	3	3	3	3	316	120

\*Dimensiones en mm. / \* Dimensions in mm.  
\*\*Masa en kg. / \*\* Mass in kg.

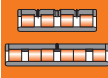

## 2.5 Rodamientos de rodillos cilíndricos de cuatro y seis hileras Four and six row cylindrical roller bearings

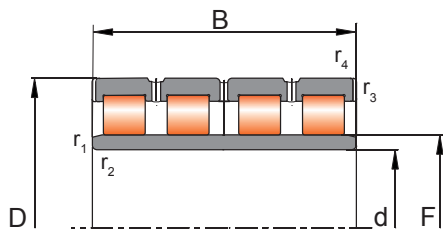

**DESIGN A**  
With solid brass cage

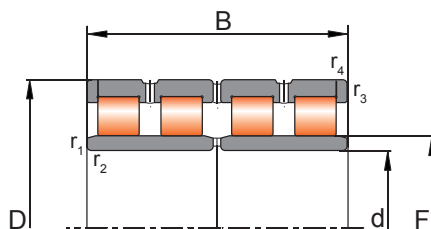

**DESIGN B**  
With solid brass cage

DIMENSIONES* BOUNDARY DIMENSIONS*			DESIGNACION DESIGNATION	DISEÑO DESIGN	E <sup>+</sup>	CAPACIDAD DE CARGA (kN) LOAD RATING (kN)			CARGA LIMITE DE FATIGA (kN) FATIGUE LIMIT LOAD (kN)	
d	D	B				dyn. Cr	dyn. E <sup>+</sup> Cr E <sup>+</sup>	stat. Cor	Cu	
280	410	300	FR690300-B	B	E <sup>+</sup>	3.300	3.450	7.400	750	
	420	300	FR700300-B	B	E <sup>+</sup>	3.300	3.410	7.200	720	
290	390	190	FR680190-B	B	E <sup>+</sup>	1.900	2.050	4.500	445	
	410	240	FR700240-B	B	E <sup>+</sup>	2.200	2.340	5.600	570	
	420	300	FR710300-B	B	E <sup>+</sup>	2.700	2.790	7.400	730	
	440	310	FR730310-B	B	E <sup>+</sup>	3.800	4.000	7.000	700	
300	400	300	FR700300-B	B	E <sup>+</sup>	2.400	2.500	6.800	720	
	420	240	FR720240-A	A	E <sup>+</sup>	1.900	2.000	5.450	570	
	420	300	FR720300-B	B	E <sup>+</sup>	3.500	3.650	8.100	850	
	460	270	FR760270-B	B	E <sup>+</sup>	2.500	2.670	5.450	550	
	460	350	FR760350-B	B	E <sup>+</sup>	5.200	5.500	9.700	960	
310	430	240	FR740240-A	A	E <sup>+</sup>	2.190	2.250	5.950	610	
320	460	240	FR780240-B	B	E <sup>+</sup>	2.400	2.500	6.600	690	
	460	340	FR780340-B	B	E <sup>+</sup>	3.300	3.500	9.500	920	
	470	350	FR790350-B	B	E <sup>+</sup>	4.800	5.000	9.500	950	
	480	350	FR800350-B	B	E <sup>+</sup>	4.800	5.000	10.000	970	
330	430	230	FR760230-A	A	E <sup>+</sup>	1.900	1.980	5.640	590	
	440	200	FR770200-A	A	E <sup>+</sup>	1.700	1.820	4.850	500	
	460	340	FR790340-B	B	E <sup>+</sup>	3.500	3.700	9.700	950	
340	450	250	FR790250-A	A	E <sup>+</sup>	2.200	2.300	6.600	690	
	480	350	FR820350-B	B	E <sup>+</sup>	4.200	4.400	10.500	1.100	
	490	300	FR830300-B	B	E <sup>+</sup>	3.200	3.350	8.300	900	
	500	370	FR840370-B	B	E <sup>+</sup>	4.900	5.200	11.500	1.150	
	560	380	FR900380-C	C	E <sup>+</sup>	6.500	6.800	12.500	1.300	
350	500	380	FR850380-C	C	E <sup>+</sup>	4.500	4.700	10.800	1.120	
	500	410	FR850410-C	C	E <sup>+</sup>	5.500	5.700	13.700	1.450	
	520	300	FR870300-C	C	E <sup>+</sup>	3.900	4.100	9.000	920	
360	480	290	FR840290-A	A	E <sup>+</sup>	2.600	2.800	8.100	870	
	500	250	FR860250-A	A	E <sup>+</sup>	3.300	3.500	7.350	680	
	510	370	FR870370-B	B	E <sup>+</sup>	3.500	3.700	10.000	970	
	510	400	FR870400-C	C	E <sup>+</sup>	4.000	4.250	11.500	1.150	
	520	380	FR880380-C	C	E <sup>+</sup>	5.500	5.800	11.500	1.150	

\*Dimensiones en mm. / \* Dimensions in mm.

\*\*Masa en kg. / \*\* Mass in kg.

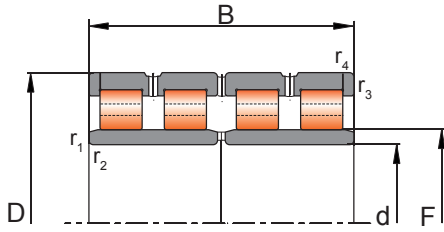

**DESIGN C**  
With pin cage

DESIGNACION DESIGNATION	$r_1, r_2$ (min)	$r_3, r_4$ (min)	DIMENSIONES SECUNDARIAS SECONDARY DIMENSIONS		MASA** MASS**
			F	F	
FR690300-B	4	4		313	132
FR700300-B	4	4		319	150
FR680190-B	2,1	2,1		316	67
FR700240-B	3	3		320	102
FR710300-B	3	3		327	141
FR730310-B	4	4		328	170
FR700300-B	3	3		328	104
FR720240-A	3	3		334	106
FR720300-B	7x20°	1,5		332	130
FR760270-B	3	3		344	162
FR760350-B	4	2,5		341	240
FR740240-A	3	3		344,5	107
FR780240-B	3	3		364	140
FR780340-B	3	3		360	178
FR790350-B	3	3		357	200
FR800350-B	4	1,5		364	225
FR760230-A	3	3		358	87,4
FR770200-A	3	3		360	83,6
FR790340-B	10,5x20°	1,5		365	175
FR790250-A	4	4		371	124,4
FR820350-B	10x20°	1,5		378	205
FR830300-B	4	4		377	187
FR840370-B	6	3		385	260
FR900380-C	4	1,5		396	350
FR850380-C	5	5		389	241
FR850410-C	11,5x20°	3		388	285
FR870300-C	5	5		401	220
FR840290-A	3	3		388	148
FR860250-A	3	3		394	145
FR870370-B	4	4		400	245
FR870400-C	5	5		397	262
FR880380-C	13,5x20°	2		405	265

\*Dimensiones en mm. / \* Dimensions in mm.  
\*\*Masa en kg. / \*\* Mass in kg.

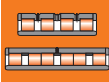

## 2.5 Rodamientos de rodillos cilíndricos de cuatro y seis hileras Four and six row cylindrical roller bearings

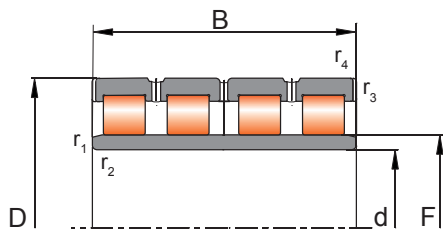

**DESIGN A**  
With solid brass cage

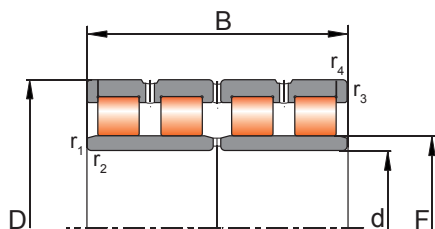

**DESIGN B**  
With solid brass cage

DIMENSIONES* BOUNDARY DIMENSIONS*			DESIGNACION DESIGNATION	DISEÑO DESIGN	E <sup>+</sup>	CAPACIDAD DE CARGA (kN) LOAD RATING (kN)			CARGA LIMITE DE FATIGA (kN) FATIGUE LIMIT LOAD (kN)	
d	D	B				dyn. Cr	dyn. E <sup>+</sup> Cr E <sup>+</sup>	stat. Cor	Cu	
370	480	230	FR850230-A	A	E <sup>+</sup>	2.000	2.100	6.300	655	
	520	380	FR890380-C	C	E <sup>+</sup>	5.800	6.000	11.500	1.200	
	520	400	FR890400-C	C	E <sup>+</sup>	4.500	4.750	11.900	1.220	
380	520	280	FR900280-B	B	E <sup>+</sup>	2.800	2.900	7.200	630	
	520	300	FR900300-B	B	E <sup>+</sup>	3.400	3.550	9.500	930	
	540	300	FR920300-C	C	E <sup>+</sup>	4.800	5.000	11.000	1.000	
	540	400	FR920400-B	B	E <sup>+</sup>	6.200	6.600	14.000	1.300	
	560	300	FR940300-C	C	E <sup>+</sup>	4.600	4.800	9.500	930	
	560	325	FR940325-C	C	E <sup>+</sup>	4.900	5.150	11.000	1.000	
390	540	320	FR930320-B	B	E <sup>+</sup>	4.900	5.100	11.500	1.150	
	550	310	FR940310-B	B	E <sup>+</sup>	4.800	5.000	11.200	1.100	
	550	400	FR940400-C	C	E <sup>+</sup>	5.900	6.200	12.400	1.200	
400	540	380	FR940380-C	C	E <sup>+</sup>	4.300	4.550	10.000	1.310	
	560	400	FR960400-C	C	E <sup>+</sup>	4.200	4.400	11.800	1.350	
	560	410	FR960410-C	C	E <sup>+</sup>	5.700	6.000	16.000	1.500	
	590	440	FR990440-C	C	E <sup>+</sup>	6.800	7.100	16.500	1.500	
410	560	400	FR970400-C	C	E <sup>+</sup>	6.300	6.700	15.000	1.370	
	600	440	FR1010440-C	C	E <sup>+</sup>	7.400	7.900	17.800	1.650	
420	580	260	FR1000260-B	B	E <sup>+</sup>	3.500	3.650	9.600	930	
	580	320	FR1000320-B	B	E <sup>+</sup>	4.300	4.500	11.000	1.050	
	600	440	FR1020440-C	C	E <sup>+</sup>	7.600	8.000	17.100	1.600	
	620	400	FR1040400-B	B	E <sup>+</sup>	6.700	7.000	15.600	1.500	
430	570	340	FR1000340-C	C	E <sup>+</sup>	5.200	5.500	14.000	1.170	
440	620	450	FR1060450-C	C	E <sup>+</sup>	7.600	8.000	18.500	1.620	
	650	355	FR1090355-C	C	E <sup>+</sup>	6.400	6.700	14.000	1.150	
	660	340	FR1100340-C	C	E <sup>+</sup>	6.300	6.700	13.500	1.100	
450	590	300	FR1040300-A	A	E <sup>+</sup>	3.800	4.000	12.000	1.080	
	590	435	FR1040435-C	C	E <sup>+</sup>	7.600	8.000	18.000	1.720	
460	610	322	FR1070322-B	B	E <sup>+</sup>	3.900	4.100	14.600	1.100	
	620	400	FR1080400-B	B	E <sup>+</sup>	6.200	6.500	17.000	1.500	
	650	355	FR1110355-B	B	E <sup>+</sup>	6.000	6.300	14.600	1.250	
	650	424	FR1110424-C	C	E <sup>+</sup>	7.500	8.000	18.500	1.600	

\*Dimensiones en mm. / \* Dimensions in mm.

\*\*Masa en kg. / \*\* Mass in kg.

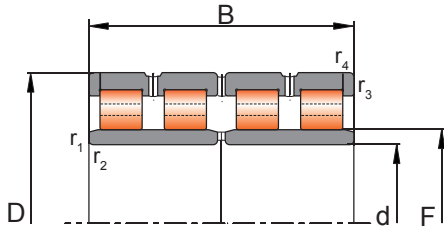

**DESIGN C**  
With pin cage

DESIGNACION DESIGNATION	r <sub>1</sub> , r <sub>2</sub> (min)	r <sub>3</sub> , r <sub>4</sub> (min)	DIMENSIONES SECUNDARIAS SECONDARY DIMENSIONS		MASA** MASS**
			F		
FR850230-A	5	5		400	106
FR890380-C	10x20°	1,5		409	255
FR890400-C	5	5		413	268
FR900280-B	4	4		426	185
FR900300-B	4	4		416	210
FR920300-C	8,5x20°	2		421	220
FR920400-B	5	2		422	295
FR940300-C	13,5x20°	2		424	260
FR940325-C	13,5x20°	2		428	265
FR930320-B	10x20°	2		431	230
FR940310-B	11x20°	4		430	240
FR940400-C	4	4		434	303
FR940380-C	5	2		436	273
FR960400-C	5	5		446	303
FR960410-C	12x20°	2		445	314
FR990440-C	5	5		450	415
FR970400-C	11x20°	2		450	300
FR1010440-C	13x20°	1,6		460	425
FR1000260-B	4	4		468	210
FR1000320-B	4	4		463	250
FR1020440-C	14x20°	1,6		470	410
FR1040400-B	4	4		473	430
FR1000340-C	5	2		465	260
FR1060450-C	12x20°	3		487	472
FR1090355-C	12,5x20°	4		494	420
FR1100340-C	6	6		492	430
FR1040300-A	12x45°	4		490	245
FR1040435-C	5	2		486	345
FR1070322-B	5	5		499	295
FR1080400-B	4	4		502	342
FR1110355-B	12x20°	3		509,5	380
FR1110424-C	6	3		510	448

\*Dimensiones en mm. / \* Dimensions in mm.  
\*\*Masa en kg. / \*\* Mass in kg.

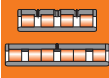

## 2.5 Rodamientos de rodillos cilíndricos de cuatro y seis hileras Four and six row cylindrical roller bearings

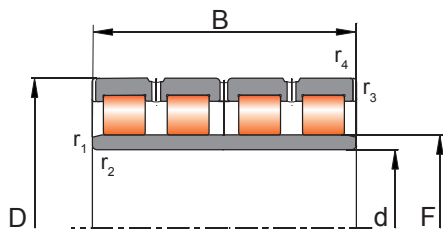

**DESIGN A**  
With solid brass cage

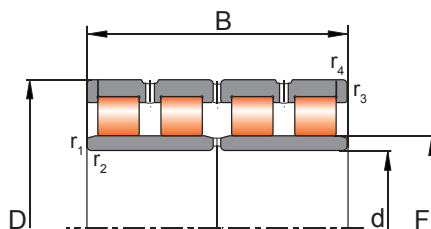

**DESIGN B**  
With solid brass cage

DIMENSIONES* BOUNDARY DIMENSIONS*			DESIGNACION DESIGNATION	DISEÑO DESIGN	E <sup>+</sup>	CAPACIDAD DE CARGA (kN) LOAD RATING (kN)			CARGA LIMITE DE FATIGA (kN) FATIGUE LIMIT LOAD (kN)	
d	D	B				dyn. Cr	dyn. E <sup>+</sup> Cr E <sup>+</sup>	stat. Cor	Cu	
460	650	470	FR1110470-C	C	E <sup>+</sup>	8.800	9.200	22.000	1.950	
480	650	340	FR1130340-B	B	E <sup>+</sup>	6.100	6.500	16.000	1.400	
	650	420	FR1130420-B	B	E <sup>+</sup>	7.600	8.000	21.500	1.700	
650	450	FR1130450-C	C	E <sup>+</sup>	8.000	8.500	20.500	1.720		
680	420	FR1160420-B	B	E <sup>+</sup>	8.300	8.700	20.000	1.750		
680	500	FR1160500-C	C	E <sup>+</sup>	8.700	9.200	23.000	1.800		
700	500	FR1180500-C	C	E <sup>+</sup>	11.400	12.000	22.000	2.100		
700	530	FR1180530-C	C	E <sup>+</sup>	10.500	11.000	21.100	2.060		
500	650	260	FR1150260-B	B	E <sup>+</sup>	3.700	3.900	10.200	970	
	670	450	FR1170450-C	C	E <sup>+</sup>	8.100	8.600	21.300	2.050	
680	450	FR1180450-C	C	E <sup>+</sup>	8.460	9.000	22.000	2.000		
690	470	FR1190470-C	C	E <sup>+</sup>	7.300	7.700	22.500	2.150		
690	510	FR1190510-C	C	E <sup>+</sup>	8.000	8.400	24.000	2.200		
700	500	FR1200500-C	C	E <sup>+</sup>	9.900	10.500	24.500	2.240		
710	480	FR1210480-C	C	E <sup>+</sup>	8.400	8.800	21.800	2.050		
720	400	FR1220400-C	C	E <sup>+</sup>	7.400	7.800	17.800	1.550		
720	530	FR1220530-C	C	E <sup>+</sup>	10.300	10.800	28.500	2.400		
510	670	320	FR1180320-B	B	E <sup>+</sup>	4.700	5.000	13.500	1.050	
	680	500	FR1190500-C	C	E <sup>+</sup>	8.600	9.000	25.500	2.250	
730	520	FR1240520-C	C	E <sup>+</sup>	12.400	13.000	28.000	2.450		
760	550	FR1270550-C	C	E <sup>+</sup>	11.300	12.000	27.000	2.300		
520	735	535	FR1255535-C	C	E <sup>+</sup>	8.500	9.000	26.600	2.300	
	750	530	FR1270530-C	C	E <sup>+</sup>	12.500	13.100	28.000	2.450	
530	760	520	FR1290520-C	C	E <sup>+</sup>	11.300	12.000	28.500	2.500	
	780	500	FR1310500-C	C	E <sup>+</sup>	8.900	9.400	21.200	1.900	
780	570	FR1310570-C	C	E <sup>+</sup>	12.600	13.300	31.000	2.600		
870	670	FR1400670-C	C	E <sup>+</sup>	19.800	21.000	37.500	3.200		
550	740	540	FR1290540-C	C	E <sup>+</sup>	10.300	10.900	27.500	2.450	
	800	520	FR1350520-C	C	E <sup>+</sup>	9.400	9.800	26.500	2.200	
800	560	FR1350560-C	C	E <sup>+</sup>	11.500	12.100	28.500	2.500		
560	680	360	FR1240360-C	C	E <sup>+</sup>	5.400	5.700	16.500	1.450	
	820	600	FR1380600-C	C	E <sup>+</sup>	13.500	14.200	33.400	2.800	

\*Dimensiones en mm. / \* Dimensions in mm.

\*\*Masa en kg. / \*\* Mass in kg.



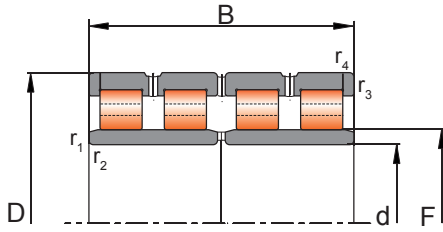

**DESIGN C**  
With pin cage

DESIGNACION DESIGNATION	$r_1, r_2$ (min)	$r_3, r_4$ (min)	DIMENSIONES SECUNDARIAS SECONDARY DIMENSIONS		MASA** MASS**
			F		
FR1110470-C	14x20°	2,5		509	500
FR1130340-B	5	5		522	320
FR1130420-B	15x20°	3		522	440
FR1130450-C	15x20°	3		525	435
FR1160420-B	15x20°	3		528	515
FR1160500-C	13x20°	3		528	605
FR1180500-C	6	4		534	660
FR1180530-C	6	6		536	695
FR1150260-B	5	5		542	225
FR1170450-C	15x20°	4		556	460
FR1180450-C	5	2		550	480
FR1190470-C	5	5		547	590
FR1190510-C	6	6		552	590
FR1200500-C	6	3		554	615
FR1210480-C	18x20°	5		558	610
FR1220400-C	6	3		558	530
FR1220530-C	17x20°	3		568	730
FR1180320-B	5	5		554	335
FR1190500-C	7,5x20°	5		560	520
FR1240520-C	6	3		565	735
FR1270550-C	16x20°	3		570	950
FR1255535-C	5	5		574,5	740
FR1270530-C	6	6		576	790
FR1290520-C	12x20°	6		587	775
FR1310500-C	6	6		591	805
FR1310570-C	15x20°	2,5		601	950
FR1400670-C	7,5	5		615	1.680
FR1290540-C	15x20°	2		600	635
FR1350520-C	6	6		622	950
FR1350560-C	18,5x20°	4		610	930
FR1240360-C	3	3		590	265
FR1380600-C	20x20°	3		625	1.080

\*Dimensiones en mm. / \* Dimensions in mm.  
\*\*Masa en kg. / \*\* Mass in kg.

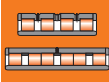

## 2.5 Rodamientos de rodillos cilíndricos de cuatro y seis hileras Four and six row cylindrical roller bearings

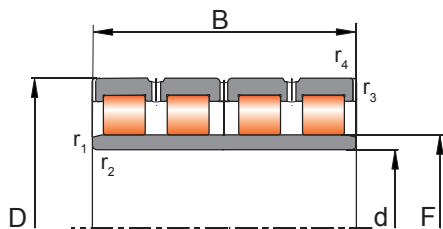

**DESIGN A**  
With solid brass cage

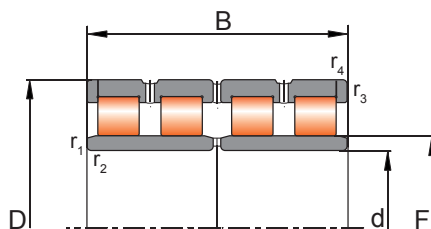

**DESIGN B**  
With solid brass cage

DIMENSIONES* BOUNDARY DIMENSIONS*			DESIGNACION DESIGNATION	DISEÑO DESIGN	E <sup>+</sup>	CAPACIDAD DE CARGA (kN) LOAD RATING (kN)			CARGA LIMITE DE FATIGA (kN) FATIGUE LIMIT LOAD (kN)	
d	D	B				dyn. Cr	dyn. E <sup>+</sup> Cr E <sup>+</sup>	stat. Cor	Cu	
560	820	630	FR1380630-C	C	E <sup>+</sup>	14.900	15.800	33.500	2.850	
570	815	594	FR1385594-C	C	E <sup>+</sup>	11.200	11.800	34.000	2.900	
580	850	640	FR1430640-C	C	E <sup>+</sup>	16.300	17.300	37.500	3.200	
600	820	550	FR1420550-B	B	E <sup>+</sup>	13.300	14.000	32.500	2.800	
	820	575	FR1420575-C	C	E <sup>+</sup>	12.300	13.000	36.000	3.100	
	870	540	FR1470540-C	C	E <sup>+</sup>	13.300	14.000	31.000	2.550	
610	870	640	FR1470640-C	C	E <sup>+</sup>	16.100	17.000	40.000	3.300	
	820	430	FR1430430-C	C	E <sup>+</sup>	8.500	9.000	23.600	2.150	
630	870	660	FR1480660-C	C	E <sup>+</sup>	14.600	15.200	40.300	3.400	
	850	436	FR1480436-B	B	E <sup>+</sup>	7.300	7.700	23.600	2.070	
650	900	650	FR1550650-C	C	E <sup>+</sup>	16.100	17.000	41.500	3.450	
	920	670	FR1570670-C	C	E <sup>+</sup>	17.100	18.000	46.300	3.800	
660	820	440	FR1480440-B	B	E <sup>+</sup>	7.100	7.500	23.000	2.000	
	880	450	FR1540450-C	C	E <sup>+</sup>	7.000	7.350	24.100	2.050	
680	940	600	FR1620600-C	C	E <sup>+</sup>	16.000	16.900	42.500	3.400	
	980	640	FR1660640-C	C	E <sup>+</sup>	17.900	19.000	44.500	3.500	
690	980	715	FR1670715-C	C	E <sup>+</sup>	20.400	21.500	52.000	4.100	
700	930	620	FR1630620-C	C	E <sup>+</sup>	14.900	15.800	43.000	3.600	
	980	700	FR1680700-C	C	E <sup>+</sup>	17.100	17.800	48.200	3.900	
710	1.000	715	FR1710715-C	C	E <sup>+</sup>	20.500	21.500	54.500	4.200	
730	960	620	FR1690620-C	C	E <sup>+</sup>	15.700	16.600	45.000	3.650	
	1.030	750	FR1760750-C	C	E <sup>+</sup>	22.400	23.500	58.500	4.500	
750	1.000	500	FR1750500-C	C	E <sup>+</sup>	12.700	13.300	33.500	2.800	
	1.000	670	FR1750670-C	C	E <sup>+</sup>	17.800	18.500	50.000	4.000	
780	1.070	780	FR1850780-C	C	E <sup>+</sup>	22.800	24.000	62.500	5.100	
800	1.080	700	FR1880700-C	C	E <sup>+</sup>	20.600	21.600	58.000	4.400	
	1.080	750	FR1880750-C	C	E <sup>+</sup>	17.500	18.400	59.000	4.600	
820	1.130	800	FR1950800-C	C	E <sup>+</sup>	23.500	25.000	67.000	5.300	
	1.160	840	FR1980840-C	C	E <sup>+</sup>	21.500	22.300	70.000	5.500	
850	1.150	840	FR2000840-C	C	E <sup>+</sup>	25.600	27.000	75.000	5.800	
	1.180	650	FR2030650-C	C	E <sup>+</sup>	16.100	17.100	52.500	4.000	
	1.220	900	FR2070900-C	C	E <sup>+</sup>	33.300	35.000	82.400	6.400	

\*Dimensiones en mm. / \* Dimensions in mm.

\*\*Masa en kg. / \*\* Mass in kg.

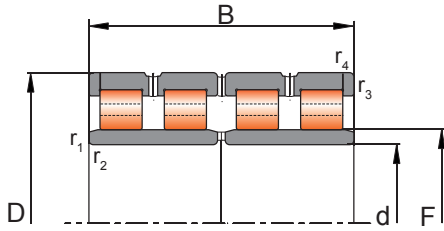

**DESIGN C**  
With pin cage

DESIGNACION DESIGNATION	$r_1, r_2$ (min)	$r_3, r_4$ (min)	DIMENSIONES SECUNDARIAS SECONDARY DIMENSIONS		MASA** MASS**
			F		
FR1380630-C	20x20°	4	625	1.120	
FR1385594-C	6	6	628	1.010	
FR1430640-C	20x20°	4	648	1.275	
FR1420550-B	6	3	660	890	
FR1420575-C	15x20°	3	660	910	
FR1470540-C	22x20°	4	672	1.150	
FR1470640-C	20x20°	3	672	1.340	
FR1430430-C	19x20°	3	665	652	
FR1480660-C	9,5	7,5	680	1.400	
FR1480436-B	6	6	690	720	
FR1550650-C	20x20°	7,5	704	1.260	
FR1570670-C	18x20°	4	723	1.460	
FR1480440-B	7,5	4	702	530	
FR1540450-C	6	6	727	785	
FR1620600-C	7,5	4	743	1.260	
FR1660640-C	20x20°	4	760	1.600	
FR1670715-C	20x20°	4	767,5	1.780	
FR1630620-C	18x20°	3	763	1.200	
FR1680700-C	7,5	7,5	774	1.680	
FR1710715-C	22x20°	3	787,5	1.850	
FR1690620-C	20x20°	3	790	1.220	
FR1760750-C	20x20°	3	809	2.050	
FR1750500-C	6	6	816	1.150	
FR1750670-C	20x20°	3	813	1.500	
FR1850780-C	7,5	5	853	2.220	
FR1880700-C	25x20°	3	870	1.920	
FR1880750-C	7,5	7,5	880	2.050	
FR1950800-C	7,5	7,5	903	2.500	
FR1980840-C	7,5	7,5	910	2.950	
FR2000840-C	23x20°	4	928	2.570	
FR2030650-C	7,5	7,5	945	2.270	
FR2070900-C	23x20°	5	960	3.600	

\*Dimensiones en mm. / \*Dimensions in mm.  
\*\*Masa en kg. / \*\*Mass in kg.

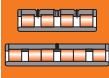

## 2.5 Rodamientos de rodillos cilíndricos de cuatro y seis hileras Four and six row cylindrical roller bearings

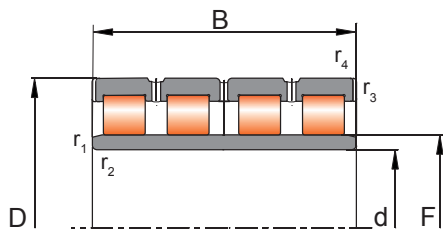

**DESIGN A**  
With solid brass cage

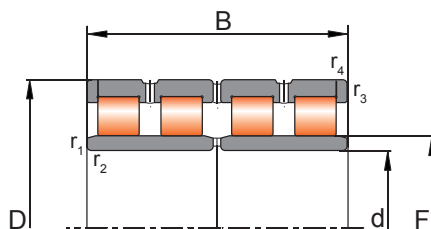

**DESIGN B**  
With solid brass cage

DIMENSIONES* BOUNDARY DIMENSIONS*			DESIGNACION DESIGNATION	DISENO DESIGN	$\epsilon^+$	CAPACIDAD DE CARGA (kN) LOAD RATING (kN)			CARGA LIMITE DE FATIGA (kN) FATIGUE LIMIT LOAD (kN)
d	D	B				dyn. Cr	dyn. $\epsilon^+$ Cr $\epsilon^+$	stat. Cor	Cu
900	1.220	840	FR2120840-C	C	$\epsilon^+$	27.200	28.500	80.000	6.000
	1.280	930	FR2180930-C	C	$\epsilon^+$	32.300	34.000	90.000	6.300
950	1.360	975	FR2310975-C	C	$\epsilon^+$	32.300	34.000	98.000	6.400
	1.360	1.000	FR23101000-C	C	$\epsilon^+$	37.100	39.000	106.000	7.200
980	1.310	880	FR2290880-C	C	$\epsilon^+$	28.500	30.000	89.000	6.700
1.000	1.360	800	FR2360800-C	C	$\epsilon^+$	28.000	29.500	83.000	6.000

\*Dimensiones en mm. / \* Dimensions in mm.  
\*\*Masa en kg. / \*\* Mass in kg.

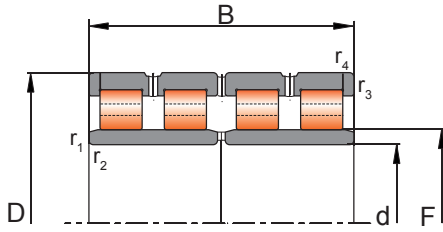

**DESIGN C**  
With pin cage

DESIGNACION DESIGNATION	$r_1, r_2$ (min)	$r_3, r_4$ (min)	DIMENSIONES SECUNDARIAS SECONDARY DIMENSIONS F	MASA** MASS**
FR2120840-C	24x20°	4	989	3.000
FR2180930-C	6	3	1.000	4.080
FR2310975-C	26x20°	6	1.075	4.900
FR23101000-C	22x20°	5	1.075	5.000
FR2290880-C	20x20°	6	1.061,7	3.310
FR2360800-C	25x20°	3	1.101	3.560

\*Dimensiones en mm. / \* Dimensions in mm.  
\*\*Masa en kg. / \*\* Mass in kg.



# 2.6

De rodillos cilíndricos en bearings

BEARINGS **NBI**  
EUROPE

81230-ME

NBI	NBI COMPLETE BEARING		NBI CASE ASSEMBLY		NBI AXIAL BEARING		NBI WASHERS		NBI CENTRAL		NBI SHIFTS LOCATING CENTRAL		NBI
	Designation	Mass	Designation	Mass	Designation	Mass	Designation	Mass	Designation	Mass	Designation	Mass	
28	9 81102-TN	0,52	E 81102-TN	0,559	G591102	WS91102	T31705	0,559	0,52	0,52	0,52	0,52	
20	9 81104-TN	0,55	E 81104-TN	0,59	G591104	WS91104	T31705	0,59	0,55	0,55	0,55	0,55	
25	10 81104-TN	0,55	E 81104-TN	0,59	G591104	WS91104	T31705	0,59	0,55	0,55	0,55	0,55	
25	42 11 81105-TN	0,55	E 81105-TN	0,59	G591105	WS91105	T31705	0,59	0,55	0,55	0,55	0,55	
47	11 81106-TN	0,55	E 81106-TN	0,59	G591106	WS91106	T31705	0,59	0,55	0,55	0,55	0,55	
52	18 81206-TN	0,52	E 81206-TN	0,57	G591206	WS91206	T31705	0,57	0,52	0,52	0,52	0,52	
30	60 18 81206-TN	0,52	E 81206-TN	0,57	G591206	WS91206	T31705	0,57	0,52	0,52	0,52	0,52	
35	52 12 81107-TN	0,07	E 81107-TN	0,08	G591107	WS91107	T31705	0,08	0,07	0,07	0,07	0,07	
35	62 18 81107-TN	0,07	E 81107-TN	0,08	G591107	WS91107	T31705	0,08	0,07	0,07	0,07	0,07	
35	65 20 81207-TN	0,24	E 81207-TN	0,25	G591207	WS91207	T31705	0,25	0,24	0,24	0,24	0,24	
40	68 13 81108-TN	0,11	E 81108-TN	0,12	G591108	WS91108	T31705	0,12	0,11	0,11	0,11	0,11	
40	68 19 81208-TN	0,16	E 81208-TN	0,17	G591208	WS91208	T31705	0,17	0,16	0,16	0,16	0,16	
45	65 14 81109-TN	0,13	E 81109-TN	0,14	G591109	WS91109	T31705	0,14	0,13	0,13	0,13	0,13	
45	65 14 81109-TN	0,13	E 81109-TN	0,14	G591109	WS91109	T31705	0,14	0,13	0,13	0,13	0,13	
45	73 20 81209-TN	0,29	E 81209-TN	0,30	G591209	WS91209	T31705	0,30	0,29	0,29	0,29	0,29	
45	85 24 81209-TN	0,14	E 81209-TN	0,15	G591209	WS91209	T31705	0,15	0,14	0,14	0,14	0,14	
50	70 14 81110-TN	0,06	E 81110-TN	0,07	G591110	WS91110	T31705	0,07	0,06	0,06	0,06	0,06	
50	78 22 81210-TN	0,26	E 81210-TN	0,27	G591210	WS91210	T31705	0,27	0,26	0,26	0,26	0,26	
50	95 21 81210-TN	0,22	E 81210-TN	0,23	G591210	WS91210	T31705	0,23	0,22	0,22	0,22	0,22	
55	78 16 81111-TN	0,57	E 81111-TN	0,6	G591111	WS91111	T31705	0,6	0,57	0,57	0,57	0,57	
55	90 25 81211-TN	1,2	E 81211-TN	1,25	G591211	WS91211	T31705	1,25	1,2	1,2	1,2	1,2	
55	105 30 81211-TN	0,27	E 81211-TN	0,28	G591211	WS91211	T31705	0,28	0,27	0,27	0,27	0,27	
60	85 17 81112-TN	0,64	E 81112-TN	0,68	G591112	WS91112	T31705	0,68	0,64	0,64	0,64	0,64	
60	95 26 81212-TN	1,3	E 81212-TN	1,35	G591212	WS91212	T31705	1,35	1,3	1,3	1,3	1,3	
60	110 30 81212-TN	2,8	E 81212-TN	2,9	G591212	WS91212	T31705	2,9	2,8	2,8	2,8	2,8	
60	130 42 81212-TN	0,31	E 81212-TN	0,32	G591212	WS91212	T31705	0,32	0,31	0,31	0,31	0,31	
65	90 18 81113-TN	0,72	E 81113-TN	0,75	G591113	WS91113	T31705	0,75	0,72	0,72	0,72	0,72	
65	100 27 81213-TN	1,3	E 81213-TN	1,35	G591213	WS91213	T31705	1,35	1,3	1,3	1,3	1,3	
65	115 30 81213-TN	3,5	E 81213-TN	3,6	G591213	WS91213	T31705	3,6	3,5	3,5	3,5	3,5	
70	95 18 81114-TN	0,23	E 81114-TN	0,24	G591114	WS91114	T31705	0,24	0,23	0,23	0,23	0,23	
70	95 18 81114-TN	0,23	E 81114-TN	0,24	G591114	WS91114	T31705	0,24	0,23	0,23	0,23	0,23	
70	105 27 81214-TN	0,77	E 81214-TN	0,8	G591214	WS91214	T31705	0,8	0,77	0,77	0,77	0,77	

147 RODAMIENTOS DE RODILLOS CILÍNDRICOS • CYLINDRICAL ROLLER BEARINGS

Dimensiones en mm. \* Masa en g.

Rodamientos axiales de rodillos cilíndricos  
Cylindrical roller thrust bearings



índice

Características técnicas .....	170
Variantes de diseño estandarizadas .....	171
Desalineación .....	172
Tolerancias .....	172
Jaulas .....	172
Carga mínima .....	172
Carga dinámica equivalente .....	173
Carga estática equivalente .....	173
Diseño de los componentes adyacentes .....	173
Alojamientos .....	174
Dimensiones de los chaflanes .....	174
Designaciones complementarias .....	175
Tabla de dimensiones .....	178

index

Technical characteristics .....	170
Standard design variants .....	171
Misalignment .....	172
Tolerances .....	172
Cages .....	172
Minimum load .....	172
Equivalent dynamic bearing load .....	173
Equivalent static bearing load.....	173
Design of adjacent machine parts .....	173
Bearing seats .....	174
Abutment and fillet dimensions.....	174
Supplementary designations .....	175
Dimensions table .....	178

### NBI E<sup>+</sup> - SERIES CON SUPERIORES CAPACIDADES DE CARGA

NBI ha combinado los últimos avances en investigación de materiales y en metalurgia con su experiencia en diseño y fabricación de rodamientos para crear una nueva línea de rodamientos de rodillos cilíndricos con excepcionales prestaciones.

La mejora en la rugosidad de las pistas de rodadura y la optimización de los perfiles de las mismas, junto con el empleo de rodillos de un grado de precisión superior minimizan el rozamiento y optimizan la distribución de la carga. La circulación del lubricante también se favorece con un nuevo diseño de los flancos de guiado de los rodillos en las pistas.

La capacidad de aceptar desalineamientos y la capacidad de carga axial han aumentado como consecuencia de estas mejoras.

### NBI E<sup>+</sup> - SERIES WITH ENHANCED LOAD RATING CHARACTERISTICS

NBI has combined the latest achievements of metallurgy and material research with its expertise in bearing design and manufacturing to create a new line of cylindrical roller bearings with additional benefits.

Improvements in internal design features optimize the internal load distribution. Lubricant flow is enhanced by newly defined geometry of the bearings functional surfaces.

The ability to accept misalignments plus the axial load carrying capacity have increased due to these improvements. This technical progress allows for working with higher dynamic load ratings. For all questions you may have regarding the NBI E<sup>+</sup> series, please feel free to contact our engineering team.





811, 812



893, 894



K811, K812



K893, K894



GS811, GS812, GS893, GS894



WS811, WS812, WS893, WS894



ZS



## RODAMIENTOS AXIALES DE RODILLOS CILÍNDRICOS

### Características técnicas

Los rodamientos axiales de rodillos cilíndricos de las series 811 y 812 son de simple efecto y soportan carga axial en una dirección.

También se fabrican en diseños de doble hilera que corresponden a las series 893 y 894.

Los rodamientos axiales de rodillos cilíndricos son insensibles a las cargas de choque y disponen de una mayor capacidad de carga en comparación con los rodamientos de bolas axiales. Soportan cargas axiales muy altas, pero no fuerzas radiales. Proporcionan un montaje de rodamientos muy rígido para grandes cargas axiales con la ventaja de ocupar menos espacio.

Los rodamientos axiales de rodillos cilíndricos tienen un diseño simple, que consiste en una arandela del eje (WS), una arandela de alojamiento (GS), y un conjunto de rodillos cilíndricos y jaula (K).

En todos los rodamientos axiales de rodillos cilíndricos puede darse el aumento de fricción por deslizamiento en los extremos de los rodillos.

Con el fin de minimizar este efecto negativo, los rodamientos axiales de rodillos cilíndricos NBI de mayor anchura de sección, se fabrican utilizando varios rodillos cortos en cada alojamiento de la jaula en lugar de utilizar rodillos individuales largos.

Debido a su particular comportamiento cinemático, los rodamientos axiales de rodillos cilíndricos son sólo adecuados para aplicaciones de baja velocidad.

Además, se requieren unas cargas axiales mínimas para su funcionamiento óptimo.

## CYLINDRICAL ROLLER THRUST BEARINGS

### Technical characteristics

Cylindrical roller thrust Bearings series 811 and 812 are single direction acting separable axial bearings.

Cylindrical roller thrust bearings are also manufactured in designs of double row cylindrical roller corresponding to the series 893 and 894.

Cylindrical roller thrust bearings are insensitive to shock loading and feature much higher load carrying capacity compared to thrust ball bearings. They accommodate very high axial loads but no radial forces. They provide a very rigid bearing assembly for high thrust loading with less space requirement.

Cylindrical roller thrust bearings are of simple design, they consist of a shaft washer (WS), a housing washer (GS), and a cylindrical roller and cage thrust assembly (K).

With all cylindrical roller thrust bearings, increased sliding friction can occur on the end of the cylindrical rollers.

In order to minimise this negative effect, NBI cylindrical roller thrust bearings with wider sectional widths are produced using several short rollers in each cage pocket instead of using individual longer rollers.

Due to their specific kinematic behaviour, cylindrical roller thrust bearings are only suitable for low speed applications only.

Furthermore, they require minimum axial loads for their optimum function.

## Variantes de diseño estandarizadas

Los rodamientos axiales de rodillos cilíndricos NBI se fabrican con un diseño de simple efecto atendiendo a los estándares.

Los rodamientos axiales de rodillos cilíndricos de doble efecto, se fabrican utilizando una combinación de componentes de rodamientos axiales de rodillos cilíndricos de simple efecto junto con arandelas intermedias ZS.

Estas arandelas intermedias son parte de la gama de productos complementarios de NBI y están disponibles bajo pedido.

En aplicaciones con restricciones de espacio, los rodillos cilíndricos y la jaula pueden usarse sin arandelas, rodando directamente sobre las superficies adyacentes que se mecanizan como pistas de rodadura del rodamiento, (por ejemplo, templado y rectificado, etc.)

Los componentes de los rodamientos axiales de rodillos cilíndricos se utilizan con frecuencia ya sea por separado o en combinación con otros componentes en distintas aplicaciones (por ejemplo, para construir montajes axiales de rodillos de aguja) por lo tanto, están disponibles como piezas sueltas.

## Standard design variants

NBI cylindrical roller thrust bearings are produced in single direction design only as standard .

Double direction acting cylindrical roller thrust bearings are built using a combination of components from single direction acting cylindrical roller thrust bearings together with intermediate washers ZS.

Such intermediate washers are part of NBI supplementary product range and are available on request.

For application designs with space restrictions the cylindrical roller and cage thrust assemblies may be used without washers providing the contact faces of adjacent machine parts are machined as bearing raceways, (e.g. hardened and ground, etc).

The components of cylindrical roller thrust bearings are frequently used either separately or in conjunction with other components in several applications (e.g. to build needle roller thrust assemblies) therefore, they are available as loose parts.

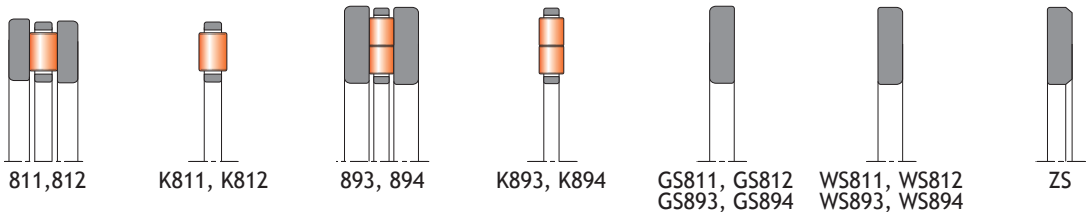

Fig. 1

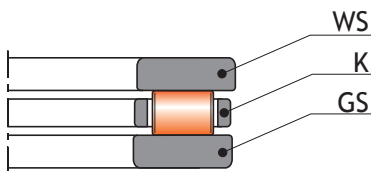

Fig. 2 Simple efecto / One direction

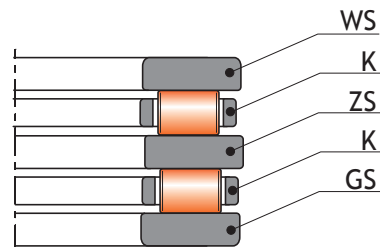

Fig. 3 Doble efecto / Double direction

## Desalineación

Ningún rodamiento axial de rodillos cilíndricos permite desalineación alguna.

La superficie de apoyo en el alojamiento y en el eje deben de ser paralelas.

## Tolerancias

Los rodamientos axiales de rodillos cilíndricos NBI estándares se fabrican con la tolerancia de una clase normal (PN).

Para las aplicaciones de mayor precisión, estos rodamientos se fabrican con precisión dimensional según las especificaciones de la clase de tolerancia (por ejemplo P6), bajo pedido.

Para los valores detallados de las clases de tolerancia ver el capítulo *Datos de rodamientos/Tolerancias*.

## Jaulas

Los rodamientos axiales de rodillos cilíndricos pequeños NBI están equipados con jaulas de poliamida (sufijo TN).

Las jaulas de poliamida son adecuadas para temperaturas de funcionamiento de hasta  $+120^{\circ}\text{C}$  ( $248^{\circ}\text{F}$ ).

Los rodamientos axiales de rodillos cilíndricos grandes NBI se fabrican ya sea con jaulas macizas de latón (sufijo M), o con jaulas macizas de acero (sufijo F).

## Carga mínima

Todos los rodamientos axiales de rodillos cilíndricos requieren una cierta carga axial mínima para garantizar un correcto funcionamiento.

Para evitar la excesiva fricción por deslizamiento, la carga axial mínima aplicada debe ser mayor que el 5% de la carga dinámica ( $C_a$ ) de los rodamientos axiales.

## Misalignment

All cylindrical roller thrust bearing types do not allow any misalignment.

The contacting surfaces of both shaft and housing seats must be parallel.

## Tolerances

NBI cylindrical roller thrust bearings are produced to normal class tolerance (PN) as standard.

For applications of higher accuracy these bearings are produced to precision tolerance class (e.g. P6) on order request.

For detailed values of the tolerance classes see chapter *Bearing data/Tolerances*.

## Cages

Small NBI cylindrical roller thrust bearings are fitted with shaft - centred polyamide cages as standard.

Polyamide cages are suitable for operating temperatures up to  $+120^{\circ}\text{C}$  ( $+248^{\circ}\text{F}$ ).

Large cylindrical roller thrust bearings are produced with either solid brass cages (suffix M), or with solid steel cages, (suffix F).

## Minimum load

All cylindrical roller thrust bearings require a certain minimum axial load to ensure a satisfactory operating function.

To prevent excessive sliding friction, the minimum axial load applied should be greater than 5% of the axial bearing dynamic load rating ( $C_a$ ).

Cuando no es posible proporcionar esta carga axial mínima, ésta deberá aportarse mediante medidas eficaces (es decir, precarga del rodamiento) usando arandelas de presión o muelles.

### Carga dinámica equivalente

Los rodamientos axiales de rodillos cilíndricos son rodamientos axiales puros, no son capaces de absorber carga radial, por lo tanto:

$$P = F_a$$

### Carga estática equivalente

Para rodamientos axiales de rodillos cilíndricos:

$$P_0 = F_a$$

### Diseño de los componentes adyacentes

Cuando los montajes de rodillos cilíndricos y jaula se utilizan sin arandelas, las superficies adyacentes se deben diseñar y mecanizar como pistas de rodadura del rodamiento (por ejemplo, templado y rectificado, etc).

La máxima desviación axial admisible de las superficies adyacentes en calidad de rodadura también deben cumplir con los requisitos de las arandelas respectivas.

Los diámetros de los agujeros de las coronas de agujas se ajustan a la tolerancia E11, mientras que las tolerancias de sus diámetros exteriores lo hacen a a13.

Las coronas axiales requieren una correcta orientación cuando se trabaja a velocidades más altas.

Para evitar un desgaste excesivo, a velocidades más altas, las superficies de guiado deben estar rectificadas.

Where such a minimum axial load is not possible the load must be increased by effective measures, (i.e. preloading the bearing) using pressure washers or springs.

### Equivalent dynamic bearing load

Cylindrical roller thrust bearings are pure axial bearings, they are not able to accommodate any radial loads, therefore:

$$P = F_a$$

### Equivalent static bearing load

For cylindrical roller thrust bearings:

$$P_0 = F_a$$

### Design of adjacent machine parts

When cylindrical roller and cage thrust assemblies are used without washers adjacent machine parts must be designed and machined as bearing raceways (i.e. hardened and ground etc).

The maximum permissible axial runout of the adjacent surfaces acting as raceway must also meet the requirements of the respective washers.

For detailed information see chapter *Design of bearing location*.

The bore diameters of cage thrust assemblies are conformed to E11 tolerance, whilst the tolerances of their outer diameters are conformed to a13.

Cage thrust assemblies require an effective guidance when operating at higher speeds.

To avoid excessive wear, at higher speeds, the guiding surfaces must be ground.

## Alojamientos para rodamientos axiales de rodillos cilíndricos

Para el diseño de los alojamientos de los rodamientos axiales de rodillos cilíndricos, las siguientes tolerancias han demostrado ser satisfactorias en la práctica:

## Bearing seats for cylindrical roller thrust bearings

For the design of cylindrical roller thrust bearing seats the following of tolerance fields have proven to be satisfactory in practice:

Centrado en: <i>Centred on:</i>	Tolerancias / <i>Tolerances</i>	
	Eje / <i>Shaft</i>	Alojamiento / <i>Housing</i>
Montaje de rodillos cilíndricos y jaulas <i>Cylindrical roller and cage thrust assembly</i>	h8	H9
Arandela del eje <i>Shaft washer</i>	h6	-
Arandela del alojamiento <i>Housing washer</i>	-	H7

Tabla 1. Table 1

## Dimensiones de los chaflanes

En el caso de los rodamientos axiales de rodillos cilíndricos, es necesario un apoyo eficaz de las arandelas del rodamiento, sobre la anchura total de sus pistas, por parte de las piezas adyacentes.

La arandela del rodamiento sólo puede contactar con las partes adyacentes con su cara lateral. Los radios de los redondeos de los rodamientos no deben tocar con el redondeo del eje ni del alojamiento.

Por lo tanto, el radio de redondeo más grande ( $r_g$ ) debe ser menor que el tamaño mínimo del redondeo del rodamiento ( $r_s$ ), como figura en la tabla 3 (pág. 176-177).

## Abutment and fillet dimensions

In the case of cylindrical roller thrust bearings, an effective support of the bearing washers over the total width of their raceways by adjacent machine parts is necessary.

The bearing washer must contact adjacent parts with their side face only. The fillet radii of bearing corners must not touch the shoulder fillet radii of the shaft or housing shoulders.

Therefore, the largest fillet radius ( $r_g$ ) must be smaller than the minimum fillet dimension of the bearing rings ( $r_s$ ) as listed in the following table 3 (page 176-177).

## Designaciones complementarias

Las tablas de producto recogen las configuraciones de rodamiento estandarizadas en la fecha de edición de este catálogo. Dichas configuraciones estandarizadas se reflejan en el correspondiente sufijo o sufijos de cada rodamiento.

En cualquier caso NBI puede ofrecer, bajo pedido, diseños alternativos, tanto los recogidos en la tabla siguiente como otros muchos cuya relación excede el propósito del presente catálogo y que podrán encontrarse en las publicaciones técnicas específicas de aplicaciones concretas o de series de rodamientos concretos.

En caso de requerir un diseño especial no recogido en estas páginas, consulten al Departamento Comercial de **NBI Bearings Europe**.

## Supplementary designations

The product tables show the standardized bearing configurations updated on the edition of this catalogue. These standardized configurations correspond to suffix or suffixes of each bearing.

In any case, NBI can offer, under requirement, alternative designs, comprising the ones showed in the following table or many others, whose mention exceeds the purpose of the present catalogue, and can be found in specific technical publications of concrete applications or series of specific bearings.

Should you need a special design not existent in these pages, please contact our Sales Department in **NBI Bearings Europe**.

Sufijo Suffix	Descripción	Description
<b>TN</b>	Jaula de poliamida reforzada con fibra de vidrio	<i>Glass fiber reinforced polyamide cage</i>
<b>M</b>	Jaula de latón	<i>Solid brass cage</i>
<b>P5</b>	Mayor precisión dimensional y de funcionamiento según la clase de tolerancia 5 de la ISO	<i>Increased dimensional and running accuracy to ISO tolerance class 5</i>
<b>ENH</b>	Rodamiento perteneciente a la línea <b>E*</b> Enhanced, cuyas cargas dinámicas corresponden a los valores de Cr <b>E*</b> . (Como referencia se muestran también, en las tablas de producto, los valores de Cr calculados según la norma ISO 281)	<i>E* Enhanced bearing series whose dynamic load rating corresponds to Cr E* values. (As reference, Cr values calculated according to ISO 281 are shown in the product tables)</i>

Tabla 2. Table 2

**Dimensiones de los chaflanes de los rodamientos axiales de rodillos cilíndricos**  
***Abutment and fillet dimensions for cylindrical roller thrust bearings***  
**series 811 and 812 [mm]**

Eje Shaft (mm)	Bore refe- rence nr.	Series de rodamientos / Bearing series					
		811			812		
		D <sub>3</sub>	D <sub>4</sub>	b	D <sub>3</sub>	D <sub>4</sub>	b
		min	max	min	min	max	min
15	02	25	18	0,3	-	-	-
17	03	27	20	0,3	-	-	-
20	04	32	23	0,3	-	-	-
25	05	39	28	0,6	-	-	-
30	06	44	33	0,6	49	33	0,6
35	07	49	38	0,6	56	41	1
40	08	56	44	0,6	63	45	1
45	09	61	49	0,6	68	50	1
50	10	66	54	0,6	73	55	1
55	11	73	60	0,6	84	61	1
60	12	80	65	1	89	66	1
65	13	85	70	1	94	71	1
70	14	90	75	1	99	76	1
75	15	95	80	1	104	81	1
80	16	100	85	1	109	86	1
85	17	105	90	1	117	93	1
90	18	114	96	1	127	98	1
100	20	129	106	1	140	110	1
110	22	139	116	1	150	120	1
120	24	149	126	1	160	130	1
130	26	162	138	1	179	141	1,5
140	28	172	148	1	189	151	1,5
150	30	182	158	1	204	161	1,5
160	32	192	168	1	214	171	1,5
170	34	207	178	1	227	183	1,5
180	36	217	188	1	237	193	1,5
190	38	230	200	1	256	204	2
200	40	240	210	1	266	214	2
220	44	260	230	1	286	234	2
240	48	288	252	1,5	322	258	2,1
260	52	308	272	1,5	342	278	2,1
280	56	337	293	1,5	362	298	2,1
300	60	365	315	2	398	322	2,5
320	64	385	335	2	418	342	2,5



Eje Shaft (mm)	Bore refe- rence nr.	Series de rodamientos / Bearing series					
		811			812		
		D <sub>3</sub>	D <sub>4</sub>	b	D <sub>3</sub>	D <sub>4</sub>	b
		min	max	min	min	max	min
340	68	405	355	2	438	362	2,5
360	72	425	375	2	475	385	3
380	76	445	395	2	495	405	3
400	80	465	415	2	515	425	3
420	84	485	435	2	552	448	4
440	88	522	458	2,1	572	468	4
460	92	542	478	2,1	592	488	4
480	96	562	498	2,1	621	509	4
500	/500	582	518	2,1	641	529	4
530	/530	619	551	2,5	680	560	4
560	/560	649	581	2,5	715	595	4
600	/600	689	621	2,5	764	636	4

Tabla 3. Table 3

2.6 Rodamientos axiales de cilindros cilíndricos  
Cylindrical roller thrust bearings

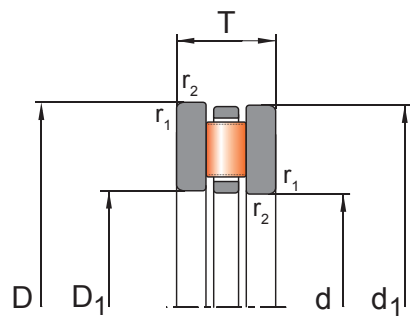

811, 812

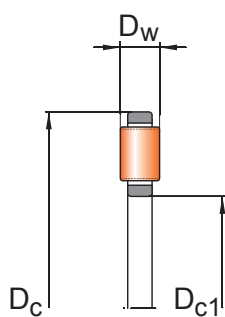

K811, K812

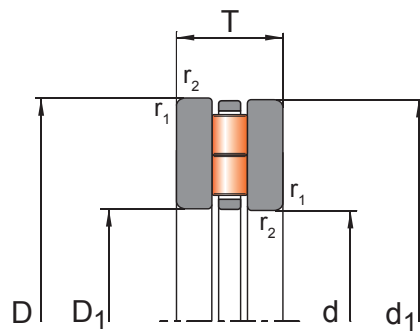

893, 894

DIMENSIONES* BOUNDARY DIMENSIONS*			ROD. COMPLETO COMPLETE BRNG.		E <sup>+</sup>	CORONA AXIAL CAGE ASSEMBLY		ARANDELAS RODAMIENTOS AXIALES AXIAL BEARING WASHERS			
d	D	T	Designación Designation	Masa** Mass**		Jaula Cage	Masa** Mass**	Alojamiento Housing	Eje Shaft locating	Central	Masa** Mass**
15	28	9	81102-TN	0,02	E*	K81102-TN	0,006	GS81102	WS81102	ZS1528	0,008
17	30	9	81103-TN	0,03	E*	K81103-TN	0,009	GS81103	WS81103	ZS1730	0,009
20	35	10	81104-TN	0,04	E*	K81104-TN	0,01	GS81104	WS81104	ZS2035	0,012
25	42	11	81105-TN	0,05	E*	K81105-TN	0,015	GS81105	WS81105	ZS2542	0,016
30	47	11	81106-TN	0,06	E*	K81106-TN	0,02	GS81106	WS81106	ZS3047	0,02
	52	16	81206-TN	0,12	E*	K81206-TN	0,03	GS81206	WS81206	-	0,045
	60	18	89306-TN	0,24	E*	K89306-TN	0,04	GS89306	WS89306	-	0,095
35	52	12	81107-TN	0,07	E*	K81107-TN	0,02	GS81107	WS81107	ZS3552	0,027
	62	18	81207-TN	0,2	E*	K81207-TN	0,04	GS81207	WS81207	-	0,076
	68	20	89307-TN	0,34	E*	K89307-TN	0,05	GS89307	WS89307	-	0,13
40	60	13	81108-TN	0,11	E*	K81108-TN	0,03	GS81108	WS81108	ZS4060	0,037
	68	19	81208-TN	0,25	E*	K81208-TN	0,08	GS81208	WS81208	-	0,084
	78	22	89308-TN	0,48	E*	K89308-TN	0,1	GS89308	WS89308	-	0,19
45	65	14	81109-TN	0,13	E*	K81109-TN	0,04	GS81109	WS81109	ZS4565	0,047
	73	20	81209-TN	0,29	E*	K81209-TN	0,09	GS81209	WS81209	-	0,1
	85	24	89309-TN	0,62	E*	K89309-TN	0,12	GS89309	WS89309	-	0,25
50	70	14	81110-TN	0,14	E*	K81110-TN	0,04	GS81110	WS81110	ZS5070	0,051
	78	22	81210-TN	0,36	E*	K81210-TN	0,1	GS81210	WS81210	-	0,13
	95	27	89310-TN	0,89	E*	K89310-TN	0,18	GS89310	WS89310	-	0,36
55	78	16	81111-TN	0,22	E*	K81111-TN	0,05	GS81111	WS81111	ZS5578	0,082
	90	25	81211-TN	0,57	E*	K81211-TN	0,17	GS81211	WS81211	-	0,2
	105	30	89311-TN	1,2	E*	K89311-TN	0,2	GS89311	WS89311	-	0,49
60	85	17	81112-TN	0,27	E*	K81112-TN	0,08	GS81112	WS81112	ZS6085	0,092
	95	26	81212-TN	0,64	E*	K81212-TN	0,18	GS81212	WS81212	-	0,23
	110	30	89312-TN	1,3	E*	K89312-TN	0,21	GS89312	WS89312	-	0,52
	130	42	89412-TN	2,8	E*	K89412-TN	0,54	GS89412	WS89412	-	1,1
65	90	18	81113-TN	0,31	E*	K81113-TN	0,09	GS81113	WS81113	ZS6590	0,11
	100	27	81213-TN	0,72	E*	K81213-TN	0,19	GS81213	WS81213	-	0,27
	115	30	89313-TN	1,3	E*	K89313-TN	0,21	GS89313	WS89313	-	0,54
	140	45	89413-TN	3,5	E*	K89413-TN	0,72	GS89413	WS89413	-	1,4
70	95	18	81114-TN	0,33	E*	K81114-TN	0,09	GS81114	WS81114	ZS7095	0,12
	105	27	81214-TN	0,77	E*	K81214-TN	0,21	GS81214	WS81214	-	0,28

\* Dimensiones en mm. / \* Dimensions in mm.  
\*\* Masa en kg. / \*\* Mass in kg.

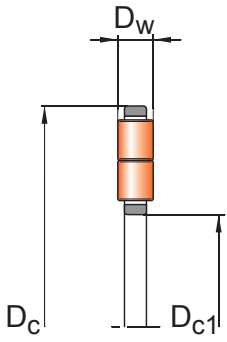

K893, K894

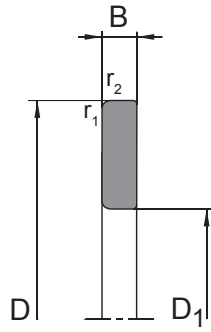

GS811, GS812  
GS893, GS894

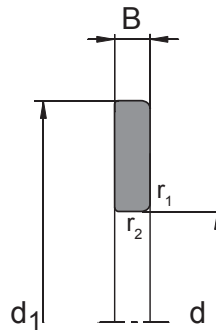

WS811, WS812  
WS893, WS894

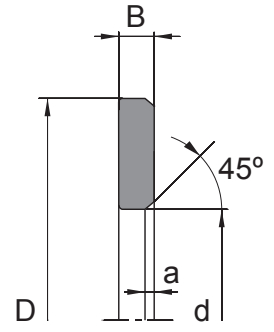

ZS

CAPACIDAD CARGA (kN) LOAD RATING (kN)			CARGA LÍMITE FATIGA / FATIGUE LIMIT LOAD (kN) Cu	VELOCIDADES LÍMITE SPEED RATINGS (rpm)		r <sub>1</sub> , r <sub>2</sub> (mm)	a	DIMENSIONES SECUNDARIAS SECONDARY DIMENSIONS			
dyn. Ca	dyn. € Ca €	stat. Coa		ng aceite ng oil	ng grasa ng grease			D <sub>1</sub>	d <sub>1</sub>	Dw	B
14	15	28	3,9	11.000	4.200	0,3	0,3	16	28	3,5	2,75
15	16	32	4,5	10.500	4.000	0,3	0,3	18	30	3,5	2,75
24	25	51	7	9.500	3.800	0,3	0,3	21	35	4,5	2,75
31	33	72	6,8	8.300	3.500	0,6	0,6	26	42	5	3
34	36	85	8	7.500	3.000	0,6	0,6	32	47	5	3
62	65	140	14	7.000	2.600	0,6	-	32	52	7,5	4,25
64	68	190	18	6.300	2.500	1	-	32	60	5,5	6,25
36	38	96	9	6.500	2.400	0,6	0,6	37	52	5	3,5
77	82	200	20	5.500	2.100	1	-	37	62	7,5	5,25
78	82	240	23	5.500	2.300	1	-	37	68	6	7
53	56	147	14	5.500	2.000	0,6	0,6	42	60	6	3,5
95	100	260	23	4.800	1.700	1	-	42	68	9	5
118	125	380	38	4.700	2.000	1	-	42	78	7	7,5
57	60	160	16	4.600	1.700	0,6	0,6	47	65	6	4
99	105	255	22	4.300	1.600	1	-	47	73	9	5,5
133	140	450	45	4.300	1.800	1	-	47	85	7,5	8,25
59	62	180	17	4.200	1.600	0,6	0,6	52	70	6	4
115	120	310	27	3.800	1.400	1	-	52	78	9	6,5
158	165	545	56	3.900	1.600	1,1	-	52	95	8	9,5
86	91	295	30	4.000	1.500	0,6	0,6	57	78	6	5
147	155	405	39	3.600	1.400	1	-	57	90	11	7
176	185	605	52	3.500	1.500	1,1	-	57	105	9	10,5
101	105	310	31	3.800	1.400	1	1	62	85	7,5	4,75
167	175	490	47	3.400	1.300	1	-	62	95	11	7,5
192	200	660	57	3.300	1.400	1,1	-	62	110	9	10,5
380	400	1.250	120	2.800	1.300	1,5	-	62	130	14	14
103	110	325	32	3.500	1.300	1	1	67	90	7,5	5,25
169	178	490	47	3.340	1.300	1	-	67	100	11	8
195	205	660	57	3.050	1.300	1,1	-	67	115	9	10,5
428	450	1.425	140	2.700	1.200	2	-	68	140	15	15
105	110	360	35	3.350	1.200	1	1	72	95	7,5	5,25
180	190	545	54	3.000	1.000	1	-	72	105	11	8

\* Dimensiones en mm. / \* Dimensions in mm.

\*\* Masa en kg. / \*\* Mass in kg.

## 2.6 Rodamientos axiales cilindricos Cylindrical roller thrust bearings

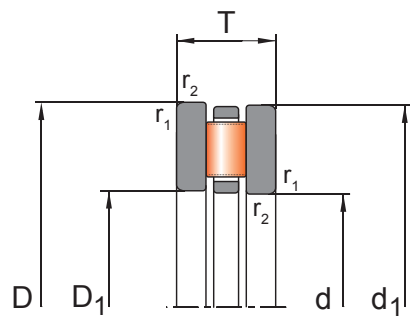

811, 812

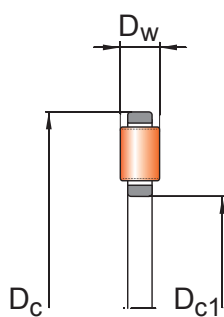

K811, K812

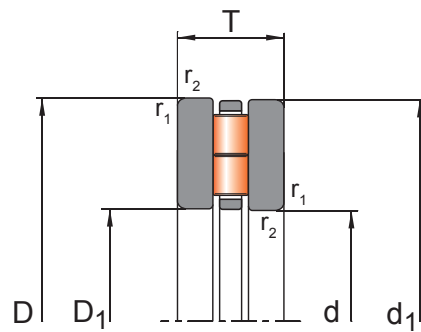

893, 894

DIMENSIONES* BOUNDARY DIMENSIONS*			ROD. COMPLETO COMPLETE BRNG.		E*	CORONA AXIAL CAGE ASSEMBLY		ARANDELAS RODAMIENTOS AXIALES AXIAL BEARING WASHERS			
d	D	T	Designación Designation	Masa** Mass**		Jaula Cage	Masa** Mass**	Alojamiento Housing	Eje Shaft locating	Central	Masa** Mass**
70	125	34	89314-TN	1,8	E*	K89314-TN	0,29	GS89314	WS89314	-	0,8
	150	48	89414-TN	4,2	E*	K89414-TN	0,76	GS89414	WS89414	-	1,7
75	100	19	81115-TN	0,39	E*	K81115-TN	0,1	GS81115	WS81115	ZS75100	0,14
	110	27	81215-TN	0,8	E*	K81215-TN	0,2	GS81215	WS81215	-	0,29
	135	36	89315-TN	2,2	E*	K89315-TN	0,38	GS89315	WS89315	-	0,97
	160	51	89415-M	6	E*	K89415-M	1,8	GS89415	WS89415	-	2,1
80	105	19	81116-TN	0,4	E*	K81116-TN	0,1	GS81116	WS81116	ZS80105	0,14
	115	28	81216-TN	0,9	E*	K81216-TN	0,23	GS81216	WS81216	-	0,33
	140	36	89316-TN	2,4	E*	K89316-TN	0,42	GS89316	WS89316	-	1
	170	54	89416-M	7	E*	K89416-M	2	GS89416	WS89416	-	2,5
85	110	19	81117-TN	0,42	E*	K81117-TN	0,12	GS81117	WS81117	ZS85110	0,15
	125	31	81217-TN	1,3	E*	K81217-TN	0,28	GS81217	WS81217	-	0,49
	150	39	89317-M	3,4	E*	K89317-M	0,93	GS89317	WS89317	-	1,2
	180	58	89417-M	8,7	E*	K89417-M	2,7	GS89417	WS89417	-	3
90	120	22	81118-TN	0,62	E*	K81118-TN	0,15	GS81118	WS81118	ZS90120	0,23
	135	35	81218-TN	1,8	E*	K81218-TN	0,54	GS81218	WS81218	-	0,61
	155	39	89318-M	3,6	E*	K89318-M	0,97	GS89318	WS89318	-	1,3
	190	60	89418-M	9,9	E*	K89418-M	3	GS89418	WS89418	-	3,5
100	135	25	81120-TN	0,95	E*	K81120-TN	0,25	GS81120	WS81120	ZS100135	0,35
	150	38	81220-TN	2,2	E*	K81220-TN	0,6	GS81220	WS81220	-	0,8
	170	42	89320-M	4,6	E*	K89320-M	1,2	GS89320	WS89320	-	1,8
	210	67	89420-M	13	E*	K89420-M	3,9	GS89420	WS89420	-	4,8
110	145	25	81122-TN	1	E*	K81122-TN	0,27	GS81122	WS81122	ZS110145	0,39
	160	38	81222-TN	2,3	E*	K81222-TN	0,53	GS81222	WS81222	-	0,88
	190	48	89322-M	6,7	E*	K89322-M	1,8	GS89322	WS89322	-	2,4
	230	73	89422-M	17	E*	K89422-M	5,1	GS89422	WS89422	-	6,2
120	155	25	81124-TN	1,1	E*	K81124-TN	0,29	GS81124	WS81124	ZS120155	0,42
	170	39	81224-TN	2,5	E*	K81224-TN	0,58	GS81224	WS81224	-	0,98
	210	54	89324-M	9,4	E*	K89324-M	2,6	GS89324	WS89324	-	3,4
	250	78	89424-M	22	E*	K89424-M	6,4	GS89424	WS89424	-	7,7
130	170	30	81126-TN	1,7	E*	K81126-TN	0,38	GS81126	WS81126	ZS130170	0,64
	190	45	81226-TN	4	E*	K81226-TN	0,92	GS81226	WS81226	-	1,5

\* Dimensiones en mm. / \* Dimensions in mm.

\*\* Masa en kg. / \*\* Mass in kg.

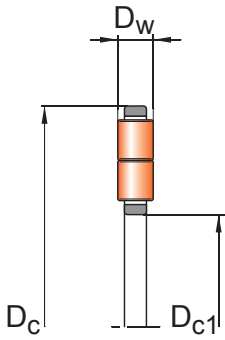

**K893, K894**

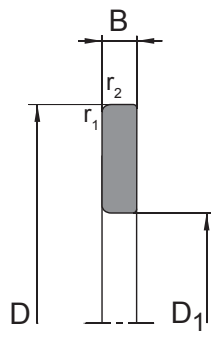

**GS811, GS812  
GS893, GS894**

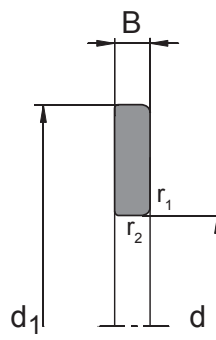

**WS811, WS812  
WS893, WS894**

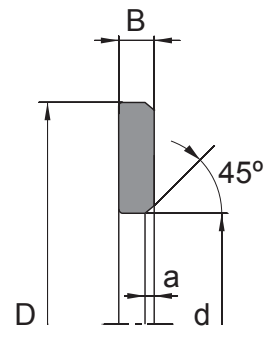

**ZS**

CAPACIDAD CARGA (kN) LOAD RATING (kN)			CARGA LÍMITE FATIGA / FATIGUE LIMIT LOAD (kN) Cu	VELOCIDADES LÍMITE SPEED RATINGS (rpm)		r <sub>1</sub> , r <sub>2</sub> (mm)	a	DIMENSIONES SECUNDARIAS SECONDARY DIMENSIONS			
dyn. Ca	dyn. E° Ca E°	stat. Coa		ng aceite ng oil	ng grasa ng grease			D <sub>1</sub>	d <sub>1</sub>	Dw	B
238	250	835	74	2.810	1.100	1,1	-	72	125	10	12
452	480	1.530	155	2.520	1.000	2	-	73	150	16	16
110	115	340	35,5	3.200	1.100	1	1	77	100	7,5	5,75
170	180	500	48	2.800	900	1	-	77	110	11	8
272	285	1.000	91	2.650	1.100	1,5	-	77	135	11	12,5
474	500	1.575	150	2.300	1.000	2	-	78	160	17	17
105	108	360	36	3.000	1.000	1	1	82	105	7,5	5,75
195	205	625	59	2.700	900	1	-	82	115	11	8,5
293	310	1.000	99	2.500	1.000	1,5	-	82	140	11	12,5
538	565	1.780	170	2.100	900	2,1	-	83	170	18	18
110	115	385	39	2.940	1.000	1	1	87	110	7,5	5,75
209	220	650	63	2.600	900	1	-	88	125	12	9,5
312	330	1.150	105	2.300	900	1,5	-	88	150	12	13,5
599	625	2.000	190	2.050	800	2,1	-	88	180	19	19,5
134	140	460	39	2.400	800	1	1	92	120	9	6,5
282	300	900	89	2.200	800	1,1	-	93	135	14	10,5
322	340	1.180	107	2.150	800	1,5	-	93	155	12	13,5
661	690	2.200	210	1.950	700	2,1	-	93	190	20	20
188	200	660	60	2.350	800	1	1	102	135	11	7
329	345	1.050	101	2.000	700	1,1	-	103	150	15	11,5
368	390	1.390	125	2.050	800	1,5	-	103	170	13	14,5
810	850	2.800	260	1.750	700	3	-	103	210	22	22,5
200	210	700	62	2.250	800	1	1	112	145	11	7
300	320	1.010	96	1.900	700	1,1	-	113	160	15	11,5
490	510	1.850	168	1.850	700	1,1	-	113	190	15	16,5
950	1.000	3.395	315	1.600	600	3	-	113	230	24	24,5
205	217	765	65	2.080	700	1	1	122	155	11	7
320	335	1.070	100	1.850	600	1,1	-	123	170	15	12
610	640	2.400	200	1.680	700	2,1	-	123	210	17	18,5
1.120	1.180	3.955	370	1.550	600	4	-	123	250	26	26
240	255	905	79	1.900	600	1	1	132	170	12	9
460	490	1.550	150	1.750	600	1,5	-	133	187	19	13

\* Dimensiones en mm. / \* Dimensions in mm.

\*\* Masa en kg. / \*\* Mass in kg.

2.6 Rodamientos axiales cilindricos  
Cylindrical roller thrust bearings

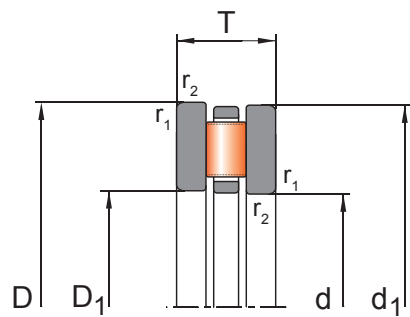

811, 812

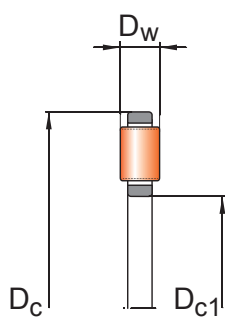

K811, K812

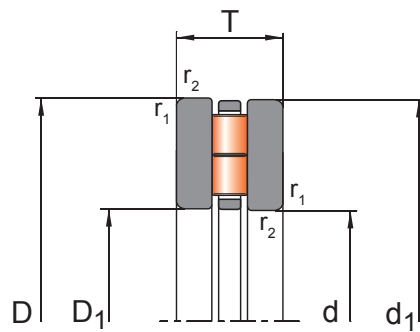

893, 894

DIMENSIONES* BOUNDARY DIMENSIONS*			ROD. COMPLETO COMPLETE BRNG.		E*	CORONA AXIAL CAGE ASSEMBLY		ARANDELAS RODAMIENTOS AXIALES AXIAL BEARING WASHERS			
d	D	T	Designación Designation	Masa** Mass**		Jaula Cage	Masa** Mass**	Alojamiento Housing	Eje Shaft locating	Central	Masa** Mass**
130	225	58	89326-M	11	E*	K89326-M	2,1	GS89326	WS89326	-	4
	270	85	89426-M	27	E*	K89426-M	8	GS89426	WS89426	-	9,5
140	180	31	81128-TN	1,9	E*	K81128-TN	0,4	GS81128	WS81128	ZS140180	0,75
	200	46	81228-M	5,1	E*	K81228-M	1,8	GS81228	WS81228	-	1,6
	240	60	89328-M	13	E*	K89328-M	2,6	GS89328	WS89328	-	4,8
	280	85	89428-M	30	E*	K89428-M	8,5	GS89428	WS89428	-	11
150	190	31	81130-TN	2,2	E*	K81130-TN	0,43	GS81130	WS81130	ZS150190	0,8
	215	50	81230-M	7,2	E*	K81230-M	2,8	GS81230	WS81230	-	2,2
	250	60	89330-M	14	E*	K89330-M	3,8	GS89330	WS89330	-	5,1
	300	90	89430-M	35	E*	K89430-M	10	GS89430	WS89430	-	13
160	200	31	81132-TN	2,1	E*	K81132-TN	0,44	GS81132	WS81132	ZS160200	0,84
	225	51	81232-M	7,6	E*	K81232-M	3	GS81232	WS81232	-	2,3
	320	95	89432-M	42	E*	K89432-M	12	GS89432	WS89432	-	15
170	215	34	81134-TN	2,4	E*	K81134-TN	0,66	GS81134	WS81134	-	1,1
	240	55	81234-M	9,3	E*	K81234-M	3,5	GS81234	WS81234	-	2,9
	340	103	89434-M	52	E*	K89434-M	15	GS89434	WS89434	-	19
180	225	34	81136-M	3,3	E*	K81136-M	1,5	GS81136	WS81136	-	1,1
	250	56	81236-M	9,9	E*	K81236-M	3,7	GS81236	WS81236	-	3,1
	360	109	89436-M	60	E*	K89436-M	18	GS89436	WS89436	-	21
190	240	37	81138-M	4,7	E*	K81138-M	1,8	GS81138	WS81138	-	1,5
	270	62	81238-M	13	E*	K81238-M	5,2	GS81238	WS81238	-	3,8
	380	115	89438-M	72	E*	K89438-M	21	GS89438	WS89438	-	26
200	250	37	81140-M	5	E*	K81140-M	1,9	GS81140	WS81140	-	1,5
	280	62	81240-M	14	E*	K81240-M	5,4	GS81240	WS81240	-	4,4
	400	122	89440-M	83	E*	K89440-M	24	GS89440	WS89440	-	29
220	270	37	81144-M	5,2	E*	K81144-M	2	GS81144	WS81144	-	1,6
	300	63	81244-M	15	E*	K81244-M	5,8	GS81244	WS81244	-	4,8
	420	122	89444-M	90	E*	K89444-M	26	GS89444	WS89444	-	32
240	300	45	81148-M	8,5	E*	K81148-M	3,3	GS81148	WS81148	-	2,6
	340	78	81248-M	26	E*	K81248-M	9,9	GS81248	WS81248	-	8,2
	440	122	89448-M	96	E*	K89448-M	27	GS89448	WS89448	-	34
260	320	45	81152-M	9,1	E*	K81152-M	3,6	GS81152	WS81152	-	2,8

\* Dimensiones en mm. / \* Dimensions in mm.

\*\* Masa en kg. / \*\* Mass in kg.

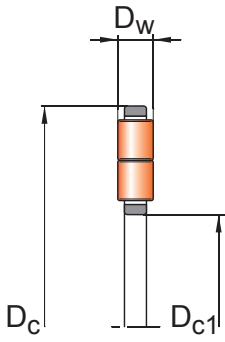

**K893, K894**

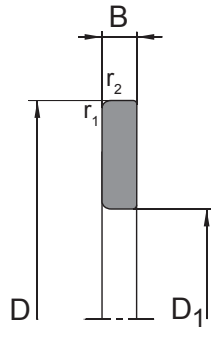

**GS811, GS812  
GS893, GS894**

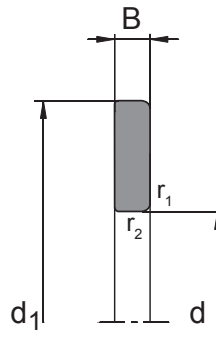

**WS811, WS812  
WS893, WS894**

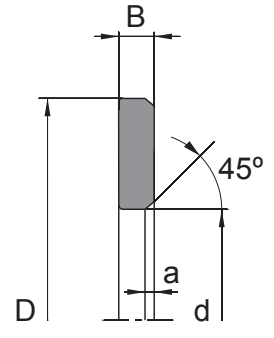

**ZS**

CAPACIDAD CARGA (kN) LOAD RATING (kN)			CARGA LÍMITE FATIGA / FATIGUE LIMIT LOAD (kN) Cu	VELOCIDADES LÍMITE SPEED RATINGS (rpm)		r <sub>1</sub> , r <sub>2</sub> (mm)	a	DIMENSIONES SECUNDARIAS SECONDARY DIMENSIONS			
dyn. Ca	dyn. E <sup>+</sup> Ca E <sup>+</sup>	stat. Coa		ng aceite ng oil	ng grasa ng grease			D <sub>1</sub>	d <sub>1</sub>	Dw	B
670	710	2.675	235	1.580	600	2,1	-	134	225	18	20
1.260	1.320	4.500	400	1.400	500	4	-	134	270	28	28,5
245	260	940	80	1.800	600	1	1	142	178	12	9,5
440	460	1.480	135	1.600	500	1,5	-	143	197	19	13,5
780	810	3.120	270	1.450	500	2,1	-	144	240	19	20,5
1.320	1.390	4.900	425	1.300	400	4	-	144	280	28	28,5
260	270	1.005	85	1.700	600	1	1	152	188	12	9,5
570	600	1.935	175	1.500	500	1,5	-	153	212	21	14,5
800	840	3.350	285	1.410	500	2,1	-	154	250	19	20,5
1.490	1.550	5.650	490	1.250	400	4	-	154	300	30	30
260	270	1.000	82	1.620	600	1	1	162	198	12	9,5
570	600	2.010	181	1.400	500	1,5	-	163	222	21	15
1.650	1.750	6.500	570	1.180	500	5	-	164	320	32	31,5
350	370	1.380	115	1.500	600	1,1	-	172	213	14	10
660	690	2.350	205	1.300	500	1,5	-	173	237	22	16,5
1.880	2.000	7.300	630	1.100	400	5	-	174	340	34	34,5
340	350	1.290	110	1.450	600	1,1	-	183	222	14	10
650	680	2.400	210	1.200	500	1,5	-	183	247	22	17
2.110	2.200	8.100	680	1.060	400	5	-	184	360	36	36,5
370	385	1.450	120	1.350	500	1,1	-	193	237	15	11
820	870	2.950	260	1.100	400	2	-	194	267	26	18
2.370	2.500	9.300	780	1.010	400	5	-	195	380	38	38,5
380	400	1.500	130	1.300	500	1,1	-	203	247	15	11
840	890	3.100	270	1.050	400	2	-	204	277	26	18
2.590	2.730	10.100	835	930	400	5	-	205	400	40	41
410	425	1.725	135	1.200	500	1,1	-	223	267	15	11
910	950	3.440	295	1.000	400	2	-	224	297	26	18,5
2.760	2.900	11.500	950	860	300	6	-	225	420	40	41
580	600	2.445	195	1.100	400	1,5	-	243	297	18	13,5
1.320	1.400	5.000	430	980	400	2,1	-	244	335	32	23
2.840	3.000	12.000	970	830	300	6	-	245	440	40	41
590	615	2.600	200	1.000	400	1,5	-	263	317	18	13,5

\* Dimensiones en mm. / \* Dimensions in mm.

\*\* Masa en kg. / \*\* Mass in kg.

2.6 Rodamientos axiales de rodillos cilíndricos  
Cylindrical roller thrust bearings

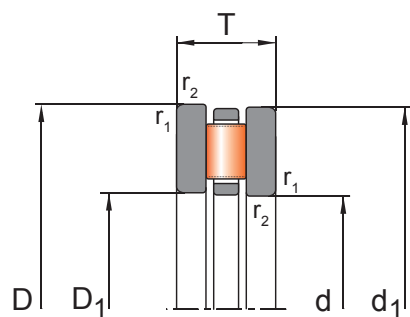

811, 812

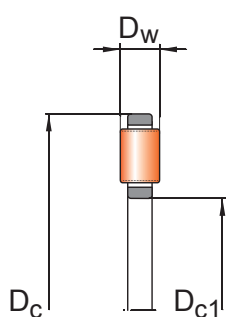

K811, K812

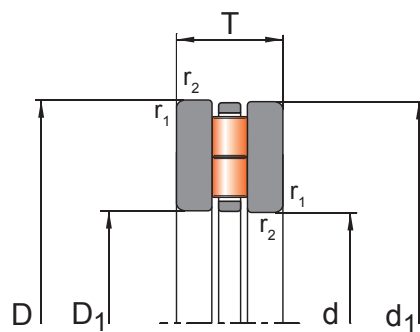

893, 894

DIMENSIONES* BOUNDARY DIMENSIONS*			ROD. COMPLETO COMPLETE BRNG.		E*	CORONA AXIAL CAGE ASSEMBLY		ARANDELAS RODAMIENTOS AXIALES AXIAL BEARING WASHERS			
d	D	T	Designación Designation	Masa** Mass**		Jaula Cage	Masa** Mass**	Alojamiento Housing	Eje Shaft locating	Central	Masa** Mass**
260	360	79	81252-M	29	E*	K81252-M	11	GS81252	WS81252	-	8,9
	480	132	89452-M	125	E*	K89452-M	37	GS89452	WS89452	-	44
280	350	53	81156-M	13	E*	K81156-M	5,3	GS81156	WS81156	-	3,7
	380	80	81256-M	31	E*	K81256-M	12	GS81256	WS81256	-	9,8
	520	145	89456-M	160	E*	K89456-M	48	GS89456	WS89456	-	56
300	380	62	81160-M	19	E*	K81160-M	7,6	GS81160	WS81160	-	5,9
	420	95	81260-M	48	E*	K81260-M	18	GS81260	WS81260	-	15
	540	145	89460-M	170	E*	K89460-M	50	GS89460	WS89460	-	60
320	400	63	81164-M	21	E*	K81164-M	8	GS81164	WS81164	-	6,4
	580	155	89464-M	205	E*	K89464-M	80	GS89464	WS89464	-	62

\*Dimensiones en mm. / \*Dimensions in mm.  
\*\*Masa en kg. / \*\*Mass in kg.



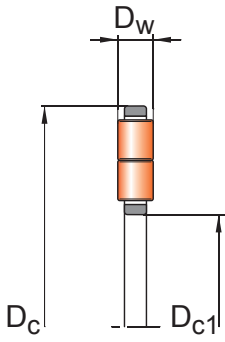

**K893, K894**

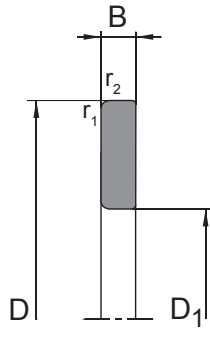

**GS811, GS812  
GS893, GS894**

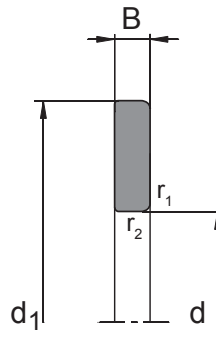

**WS811, WS812  
WS893, WS894**

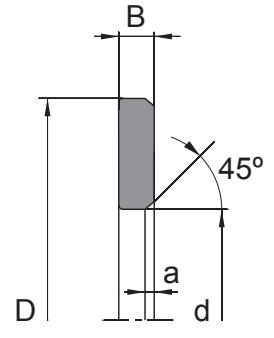

**ZS**

CAPACIDAD CARGA (kN) LOAD RATING (kN)			CARGA LÍMITE FATIGA / FATIGUE LIMIT LOAD (kN) Cu	VELOCIDADES LÍMITE SPEED RATINGS (rpm)		r <sub>1</sub> , r <sub>2</sub> (min)	a	DIMENSIONES SECUNDARIAS SECONDARY DIMENSIONS			
dyn. Ca	dyn. E° Ca E°	stat. Coa		ng aceite ng oil	ng grasa ng grease			D <sub>1</sub>	d <sub>1</sub>	Dw	B
1.370	1.435	5.300	450	900	400	2,1	-	264	355	32	23,5
3.390	3.585	14.600	1.150	750	300	6	-	265	480	44	44
800	850	3.600	275	900	400	1,5	-	283	347	22	15,5
1.430	1.500	5.600	470	800	300	2,1	-	284	375	32	24
3.980	4.150	17.500	1.350	700	300	6	-	285	520	48	48,5
1.010	1.050	4.550	360	850	300	2	-	304	376	25	18,5
1.830	1.920	7.200	580	700	300	3	-	304	415	38	28,5
4.200	4.400	18.500	1.400	660	300	6	-	305	540	48	48,5
1.050	1.100	4.800	375	800	300	2	-	324	396	25	19
5.230	5.545	19.500	1.450	630	200	7,5	-	325	575	68	43,5







BEARINGS | **NBI**<sup>®</sup>  
EUROPE | Premium  brand

NBI Bearings Europe, S.A.  
Pol. Industrial Basauri, nave 6-10  
01409, Dquendo - Álava (Spain)  
Sales phone: +34 945 898 395  
Admin. Phone: +34 945 898 397  
Fax: +34 945 898 396

[gruponbi.com](http://gruponbi.com)

Code: TC-CRB-2012/002