

**TRAFFIC IMPACT STUDY
FOR
SPECIAL EVENTS FACILITY AT
3210 JOE PARKER ROAD
HALL COUNTY, GEORGIA**



Prepared for:

***Rochester and Associates, LLC.
425 Oak Street
Gainesville, GA 30501***

Prepared By:



A&R Engineering Inc.

2160 Kingston Court, Suite O
Marietta, GA 30067
Tel: (770) 690-9255 Fax: (770) 690-9210
www.areng.com

March 24, 2023
A & R Project # 23-031

TABLE OF CONTENTS

Item	Page
1.0 Introduction	1
2.0 Existing Facilities / Conditions	3
2.1 Roadway Facilities.....	3
2.1.1 SR 323 (Gillsville Highway).....	3
2.1.2 Harmony Church Road.....	3
2.1.3 Joe Parker Road.....	3
3.0 Study Methodology	4
3.1 Unsignalized Intersections.....	4
3.2 Signalized Intersections	5
4.0 Existing 2023 Traffic Analysis.....	6
4.1 Existing Traffic Volumes.....	6
4.2 Existing Traffic Operations.....	9
5.0 Proposed Development.....	10
5.1 Trip Generation.....	11
5.2 Trip Distribution.....	11
6.0 Future 2025 Traffic Analysis	14
6.1 Future “No-Build” Conditions	14
6.1.1 Annual Traffic Growth.....	14
6.2 Future “Build” Conditions.....	14
6.3 Future “Build” Traffic Operations.....	17
7.0 Conclusions and Recommendations.....	19
7.1 Recommendations for Site Access Configuration.....	19

Appendix

LIST OF TABLES

Item	Page
Table 1 – Level-of-service Criteria for Unsignalized Intersections.....	4
Table 2 – Level-of-service Criteria for Signalized Intersections	5
Table 3 – Existing Intersection Operations	9
Table 4 – Trip Generation	11
Table 5 – Future Intersection Operations.....	17

LIST OF FIGURES

Item	Page
Figure 1 – Location Map.....	2
Figure 2 – Existing Weekday Peak Hour Volumes.....	7
Figure 3 – Existing Traffic Control and Lane Geometry	8
Figure 4 – Site Plan.....	12
Figure 5 – Trip Distribution and Site Generated Peak Hour Volumes	13
Figure 6 – Future (No-Build) Peak Hour Volumes.....	15
Figure 7 – Future (Build) Peak Hour Volumes.....	16
Figure 8 – Future Traffic Control and Lane Geometry.....	18

1.0 INTRODUCTION

The purpose of this study is to determine the traffic impact from the proposed special events facility development that will be located west of Joe Parker Road in Hall County, Georgia. The traffic analysis includes evaluation of the current operations and future conditions with the traffic generated by the development. The development will consist of a special events facility with a 7,200 square foot building and a 103-vehicle space parking lot.



The development proposes one full access driveway on Joe Parker Road.

The AM and PM peak hours have been analyzed in this study. In addition to the site access point, this study includes the evaluation of traffic operations at the intersections of:

- SR 323 (Gillsville Highway) at Harmony Church Road
- SR 323 (Gillsville Highway) at Joe Parker Road

Recommendations to improve traffic operations have been identified as appropriate and are discussed in detail in the following sections of the report. The location of the development and the surrounding roadway network are shown in Figure 1.

⊕ Study Intersection

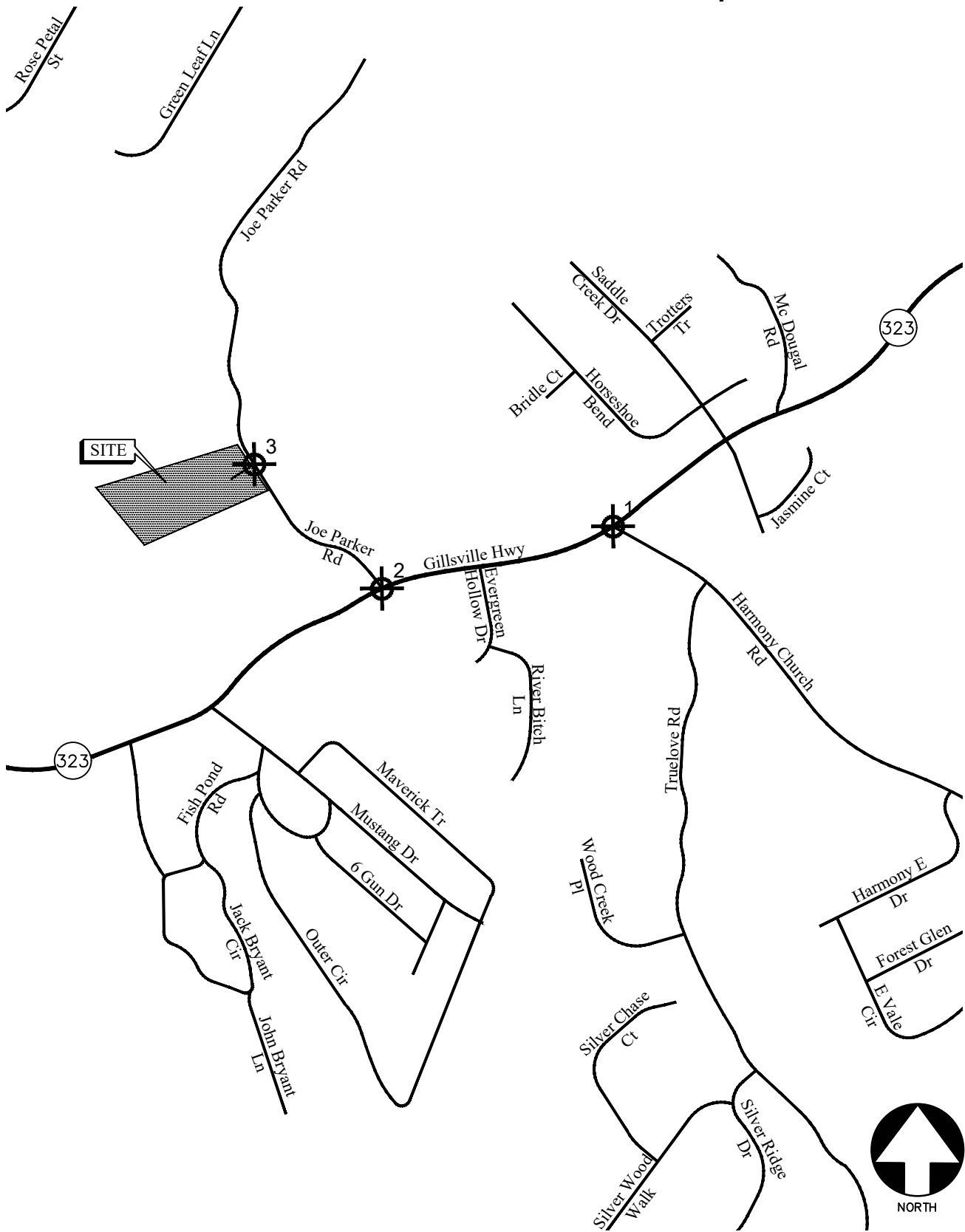

LOCATION MAP

FIGURE 1

A&R Engineering Inc.

2.0 EXISTING FACILITIES / CONDITIONS

2.1 Roadway Facilities

The following is a brief description of each of the roadway facilities located in proximity to the site:

2.1.1 SR 323 (Gillsville Highway)

SR 323 (Gillsville Highway) is an east-west, two-lane, undivided roadway with a posted speed limit of 40 mph in the vicinity of the site. Georgia Department of Transportation (GDOT) traffic counts (Station ID 139-0387) indicate that the daily traffic volume on SR 323 (Gillsville Highway) in 2021 was 12,300 vehicles per day West of Joe Parker Road. GDOT classifies SR 323 (Gillsville Highway) as a major collector roadway.

2.1.2 Harmony Church Road

Harmony Church Road is a north-south, two-lane, undivided roadway with a posted speed limit of 50 mph in the vicinity of the site.

2.1.3 Joe Parker Road

Joe Parker Road is a north-south, two-lane, undivided roadway with a posted speed limit of 25 mph in the vicinity of the site.

3.0 STUDY METHODOLOGY

In this study, the methodology used for evaluating traffic operations at each of the subject intersections is based on the criteria set forth in the Transportation Research Board’s Highway Capacity Manual, 6th edition (HCM 6). Synchro software, which utilizes the HCM methodology, was used for the analysis. The following is a description of the methodology employed for the analysis of unsignalized and signalized intersections.

3.1 Unsignalized Intersections

For unsignalized intersections controlled by a stop sign on minor streets, the level-of-service (LOS) for motor vehicles with controlled movements is determined by the computed control delay according to the thresholds stated in Table 1 below. LOS is determined for each minor street movement (or shared movement), as well as major street left turns. LOS is not defined for the intersection as a whole or for major street approaches. The LOS of any controlled movement which experiences a volume to capacity ratio greater than 1 is designated as “F” regardless of the control delay.

Control delay for unsignalized intersections includes initial deceleration delay, queue move-up time, stopped delay, and final acceleration delay. Several factors affect the control delay for unsignalized intersections, such as the availability and distribution of gaps in the conflicting traffic stream, critical gaps, and follow-up time for a vehicle in the queue.

Level-of-service is assigned a letter designation from “A” through “F”. Level-of-service “A” indicates excellent operations with little delay to motorists, while level-of-service “F” exists when there are insufficient gaps of acceptable size to allow vehicles on the side street to cross the main road without experiencing long delays.

TABLE 1 — LEVEL-OF-SERVICE CRITERIA FOR UNSIGNALIZED INTERSECTIONS		
Control Delay (sec/vehicle)	LOS by Volume-to-Capacity Ratio*	
	v/c ≤ 1.0	v/c > 1.0
≤ 10	A	F
> 10 and ≤ 15	B	F
> 15 and ≤ 25	C	F
> 25 and ≤ 35	D	F
> 35 and ≤ 50	E	F
> 50	F	F

*The LOS criteria apply to each lane on a given approach and to each approach on the minor street. LOS is not calculated for major-street approaches or for the intersection.

Source: Highway Capacity Manual, 6th edition, Exhibit 20-2 *LOS Criteria: Motorized Vehicle Mode*

3.2 Signalized Intersections

According to HCM procedures, LOS can be calculated for the entire intersection, each intersection approach, and each lane group. HCM uses control delay alone to characterize LOS for the entire intersection or an approach. Control delay per vehicle is composed of initial deceleration delay, queue move-up time, stopped delay, and final acceleration delay. Both control delay and volume-to-capacity ratio are used to characterize LOS for a lane group. A volume-to-capacity ratio of 1.0 or more for a lane group indicates failure from capacity perspective. Therefore, such a lane group is assigned LOS F regardless of the amount of control delay.

Table 2 below summarizes the LOS criteria from HCM for motorized vehicles at signalized intersection.

TABLE 2 — LEVEL-OF-SERVICE CRITERIA FOR SIGNALIZED INTERSECTIONS		
Control Delay (sec/vehicle) *	LOS for Lane Group by Volume-to-Capacity Ratio*	
	v/c ≤ 1.0	v/c > 1.0
≤ 10	A	F
> 10 and ≤ 20	B	F
> 20 and ≤ 35	C	F
> 35 and ≤ 55	D	F
> 55 and ≤ 80	E	F
> 80	F	F

*For approach-based and intersection wide assessments, LOS is defined solely by control delay

Source: Highway Capacity Manual, 6th edition, Exhibit 19-8 *LOS Criteria: Motorized Vehicle Mode*

LOS A is typically assigned when the volume-to-capacity (v/c) ratio is low and either progression is exceptionally favorable, or the cycle length is very short. LOS B is typically assigned when the v/c ratio is low and either progression is highly favorable, or the cycle length is short. However, more vehicles are stopped than with LOS A. LOS C is typically assigned when progression is favorable, or the cycle length is moderate. Individual *cycle failures* (one or more queued vehicles are not able to depart because of insufficient capacity during the cycle) may begin to appear at this level. Many vehicles still pass through the intersection without stopping, but the number of vehicles stopping is significant. LOS D is typically assigned when the v/c ratio is high and either progression is ineffective, or the cycle length is long. There are many vehicle-stops and individual cycle failures are noticeable. LOS E is typically assigned when the v/c ratio is high, progression is very poor, the cycle length is long, and individual cycle failures are frequent. LOS F is typically assigned when the v/c ratio is very high, progression is very poor, the cycle length is long, and most cycles fail to clear the queue.

4.0 EXISTING 2023 TRAFFIC ANALYSIS

4.1 Existing Traffic Volumes

Existing traffic counts were obtained at the following study intersections:

- SR 323 (Gillsville Highway) at Harmony Church Road
- SR 323 (Gillsville Highway) at Joe Parker Road

Turning movement counts were collected on Wednesday, March 08, 2023. All turning movement counts were recorded during the AM and PM peak hours between 7:00 am to 9:00 am and 4:00 pm to 6:00 pm, respectively. The four consecutive 15-minute interval volumes that summed to produce the highest volume at the intersections were then determined. These volumes make up the peak hour traffic volumes for the intersections counted and are shown in Figure 2.

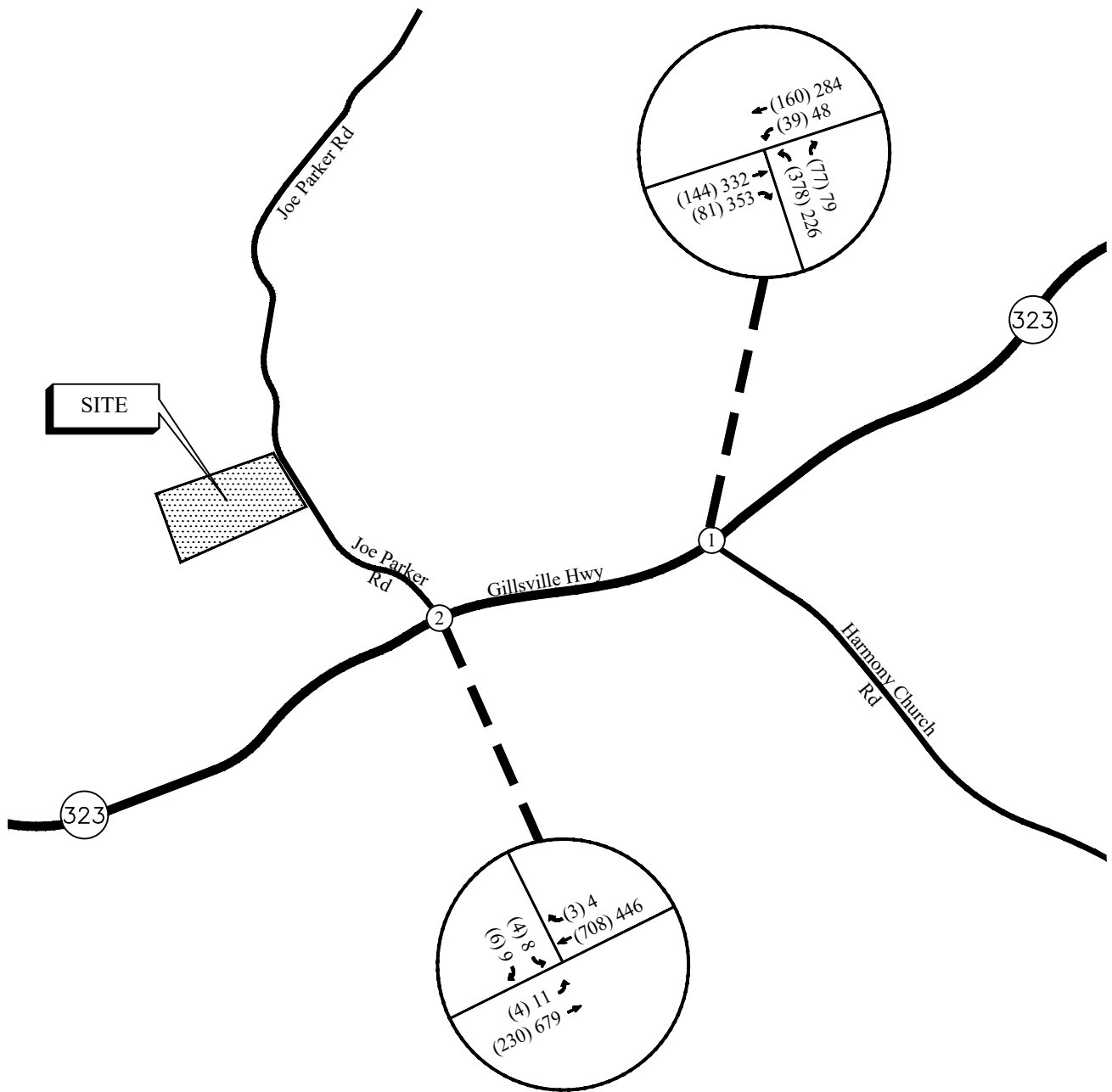



(AM) PM



EXISTING WEEKDAY PEAK-HOUR VOLUMES

FIGURE 2
A&R Engineering Inc.

LEGEND

- Ex  Existing Signed Approach
-  Existing Lane Geometry
- Ex  Existing Traffic Signal

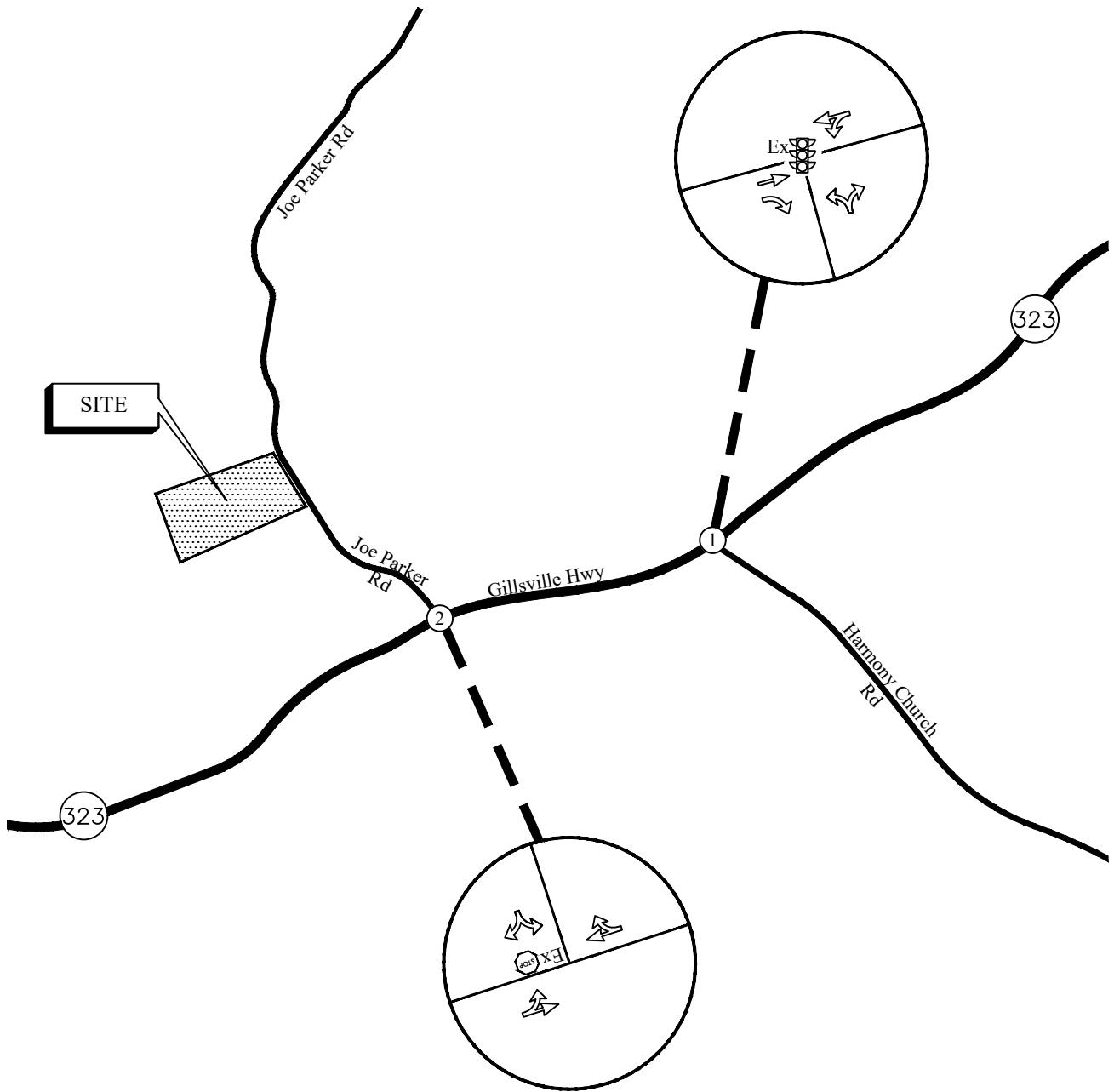

EXISTING TRAFFIC CONTROL AND LANE GEOMETRY

FIGURE 3

A&R Engineering Inc.

4.2 Existing Traffic Operations

Existing 2023 traffic operations were analyzed at the study intersections in accordance with the HCM methodology. The results of the analyses are shown in Table 3.

TABLE 3 – EXISTING INTERSECTION OPERATIONS				
Intersection		Traffic Control	LOS (Delay)	
			AM Peak Hour	PM Peak Hour
1	<u>SR 323 (Gillsville Highway) at Harmony Church Road</u>	Signalized	<u>C (25.0)</u>	<u>B (15.7)</u>
	-Eastbound Approach		A (8.8)	A (7.2)
	-Westbound Approach		A (9.4)	A (7.0)
	-Northbound Approach		D (39.7)	D (40.7)
2	<u>SR 323 (Gillsville Highway) at Joe Parker Road</u>	Stop Controlled on SB Approach	A (9.4)	A (8.3)
	-Eastbound Left		C (16.7)	C (16.7)
	-Southbound Approach			

The results of existing traffic operations analysis indicate that intersection 1 (signalized) is operating at an overall level of service “C” or better during the traffic peak hours while the approaches at intersection 2 (unsignalized) are also operating at a level of service “C” or better during both the AM and PM peak hours.

5.0 PROPOSED DEVELOPMENT

The proposed special events facility development will consist of a 7,200 square foot building and a parking lot with 103 parking spaces for guests and staff.

The development proposes one full access driveway on Joe Parker Road.



A site plan is shown in Figure 4.

5.1 Trip Generation

The 11th edition of the Institute of Transportation Engineers (ITE) Trip Generation report does not include a trip generation subcategory for special events facilities, as such developments may be used for a wide variety of purposes across different times of the day and different periods of the week/month/year. Therefore, the traffic volumes for the site-generated trips to and from this development were estimated based on its planned characteristics.

The event center will primarily be used for weddings, reunions, or other social activities that require meeting or gathering space. A 7,200 square foot building will be constructed to host these events and 103 parking spaces will be available for guests and staff to use. The facility is projected to receive approximately 250 people on average per week. It is estimated that 200 people will attend each event on average, with about 65 events being planned each year. This amounts to about 1-2 events being scheduled each week, with no single day having multiple events. A realistic scenario would involve a week where one event is scheduled for the evening on a weekday and another event occurring on Saturday or Sunday. The 7,200 SF building is being designed to accommodate up to 290 guests for weddings/parties that would be considered “peak events”. If each vehicle arriving carries an average of 2 guests across the course of a peak event, this amounts to 145 entering guest vehicles, plus an additional 7 cars being driven by facility/staff. Adding the 152 exiting vehicles at the end of the event amounts to an estimated total of 304 (entering/exiting) trips for a peak event that was reserved for a single day. However, guests will be arriving and leaving at different times throughout each event, so not all traffic will arrive or leave within a single peak hour.

To estimate peak hour traffic, a scenario with 50 entering cars (roughly 1/3 of all the entering traffic volume for the entire event) and 50 exiting cars is taken for the PM peak hour. No site-generated traffic was assigned to the AM peak hour, as the facility will generally not be used in the morning. Additionally, no analysis was conducted for Saturday peak hour traffic as weekend volumes are significantly lower due to the lack of school traffic and drivers commuting to work. Even after the addition of site-generated traffic in the future, the study area will still experience relatively low volumes compared to weekend PM peak hour traffic. The estimated total trip generation for the proposed development is shown in Table 4.

Land Use	Building Size	AM Peak Hour			PM Peak Hour			24 Hour
		Enter	Exit	Total	Enter	Exit	Total	Two-Way
Special Events Facility	7,200 SF	0	0	0	50	50	100	304

5.2 Trip Distribution

The trip distribution describes how traffic arrives and departs from the site. An overall trip distribution was developed for the site based on a review of the existing travel patterns in the area and the locations of major roadways and highways that will serve the development. The site-generated peak hour traffic volumes, shown in Table 4, were assigned to the study area intersections based on this distribution. The outer-leg distribution and AM and PM peak hour new traffic generated by the site are shown in Figure 5.

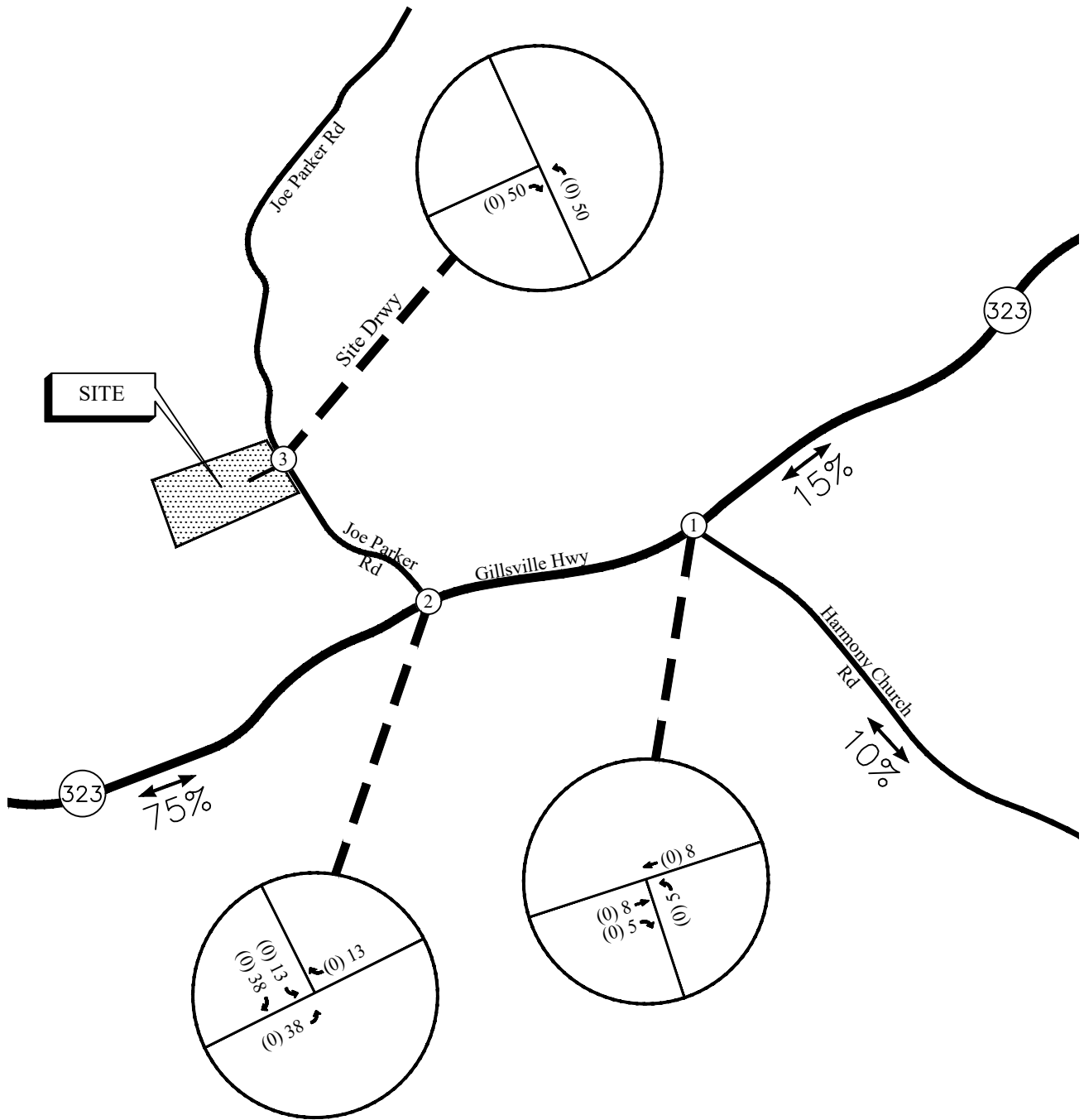

(AM) PM



TRIP DISTRIBUTION AND SITE-GENERATED
WEEKDAY PEAK HOUR VOLUMES

FIGURE 5
A&R Engineering Inc.

6.0 FUTURE 2025 TRAFFIC ANALYSIS

The future 2025 traffic operations are analyzed for the “Build” and “No-Build” conditions.

6.1 Future “No-Build” Conditions

The “No-Build” (or background) conditions provide an assessment of how traffic will operate in the study horizon year without the study site being developed as proposed, with projected increases in through traffic volumes due to normal annual growth. The Future “No-Build” volumes consist of the existing traffic volumes (Figure 2) plus increases for annual growth of through traffic.

6.1.1 Annual Traffic Growth

To evaluate future traffic operations in this area, a projection of normal traffic growth was applied to the existing volumes. The Georgia Department of Transportation recorded average daily traffic volumes at several locations in the vicinity of the site. Reviewing the growth over the last three years revealed growth of approximately 1% in the area. This growth factor was applied to the existing traffic volumes between collector and arterial roadways to estimate the future year traffic volumes prior to the addition of site-generated traffic. The resulting Future “No-Build” volumes on the roadway are shown in Figure 6.

6.2 Future “Build” Conditions

The “Build” or development conditions include the estimated background traffic from the “No-Build” conditions plus the added traffic from the proposed development. To evaluate future traffic operations in this area, the additional traffic volumes from the site (Figure 5) were added to base traffic volumes (Figure 6) to calculate the future traffic volumes after the construction of the development. These total future “Build” traffic volumes are shown in Figure 7.

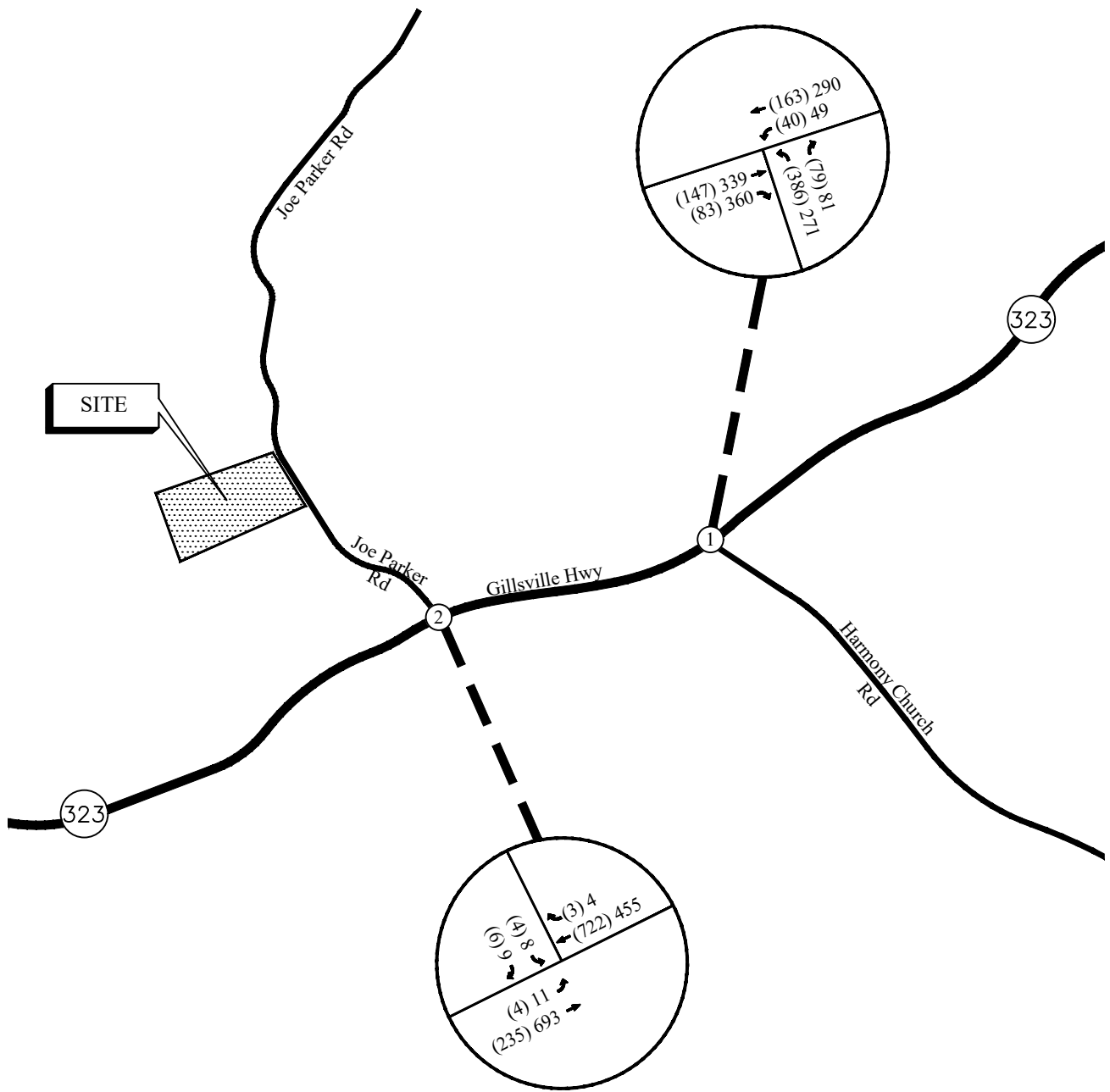

(AM) PM



FUTURE (NO-BUILD) WEEKDAY PEAK HOUR VOLUMES

FIGURE 6

A&R Engineering Inc.

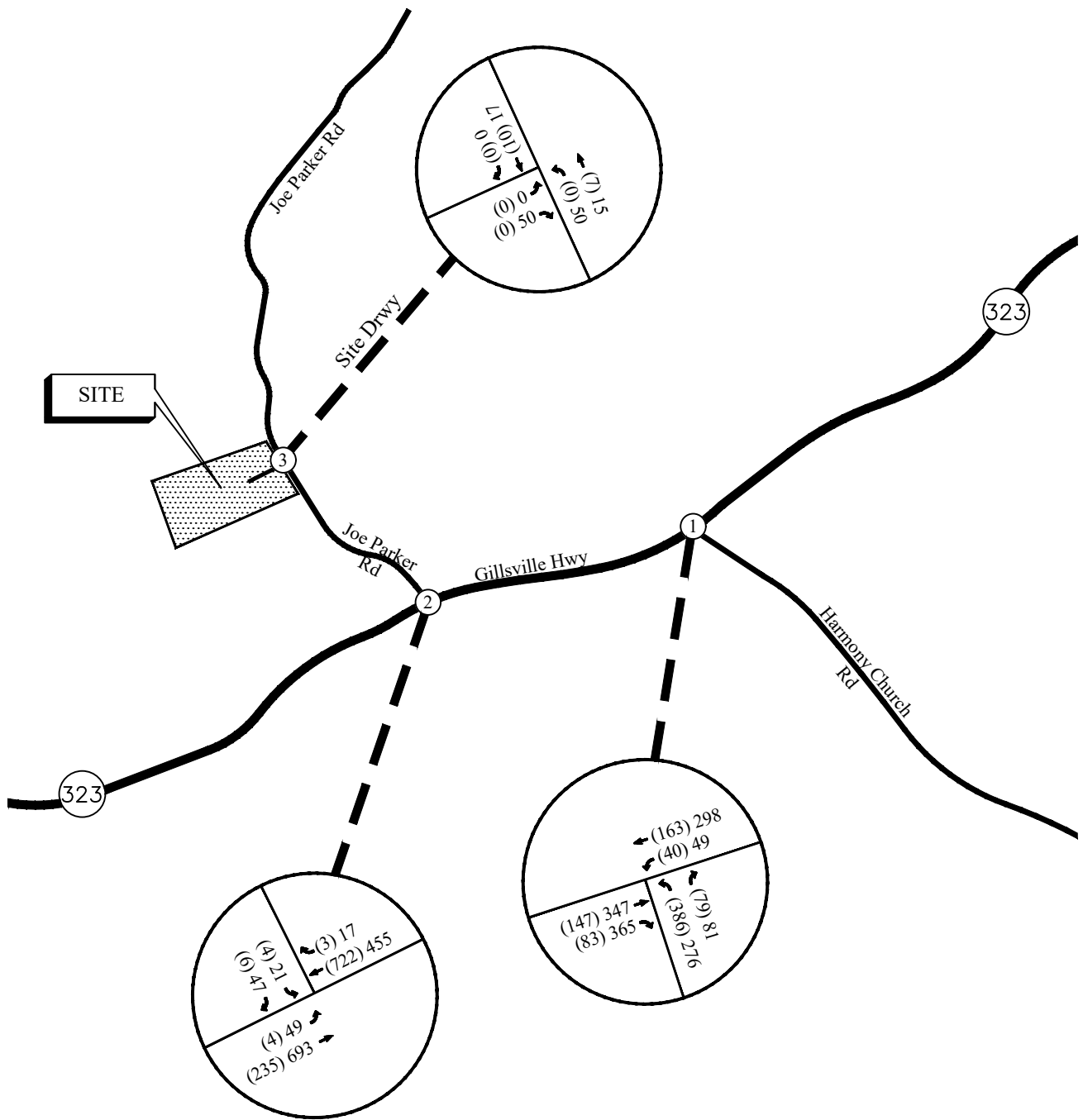

(AM) PM

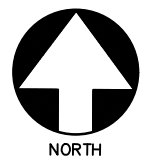

FUTURE (BUILD) WEEKDAY PEAK HOUR VOLUMES

FIGURE 7
A&R Engineering Inc.

6.3 Future “Build” Traffic Operations

The future “No-Build” and “Build” traffic operations were analysed using the volumes in Figure 6 and Figure 7, respectively. The results of the future traffic operations analysis are shown below in Table 5. Recommendations on traffic control and lane geometry are shown in Figure 8.

TABLE 5 – FUTURE INTERSECTION OPERATIONS					
Intersection		LOS (Delay)			
		NO-BUILD		BUILD	
		AM Peak	PM Peak	AM Peak	PM Peak
1	<u>SR 323 (Gillsville Highway) at Harmony Church Road</u>	<u>C (25.6)</u>	<u>B (15.7)</u>	<u>C (25.6)</u>	<u>B (15.9)</u>
	-Eastbound Approach	A (9.4)	A (6.8)	A (9.4)	A (7.0)
	-Westbound Approach	B (10.4)	A (7.2)	B (10.4)	A (7.4)
	-Northbound Approach	D (40.2)	D (41.7)	D (40.2)	D (41.9)
2	<u>SR 323 (Gillsville Highway) at Joe Parker Road</u>				
	-Eastbound Left	A (9.4)	A (8.3)	A (9.4)	A (8.5)
	-Southbound Approach	C (17.0)	C (17.0)	C (17.0)	C (18.3)
3	<u>Joe Parker Road at Site Driveway</u>				
	-Northbound Left	-	-	A (0.0)	A (7.3)
	-Eastbound Approach			A (0.0)	A (8.6)

The results of future traffic operations analysis indicate that the signalized intersection 1 (SR 323 at Harmony Church Road) will continue to operate at a level of service “C” or better during the traffic peak hours, while the approaches at the unsignalized intersections will operate at level of service “C” or better in both the AM and PM peak hours.

LEGEND

- | | | | |
|--|--------------------------|---|--------------------------|
| Ex  | Existing Signed Approach |  | Proposed Signed Approach |
|  | Existing Lane Geometry |  | Proposed Lane Geometry |
| Ex  | Existing Traffic Signal |  | Proposed Traffic Signal |

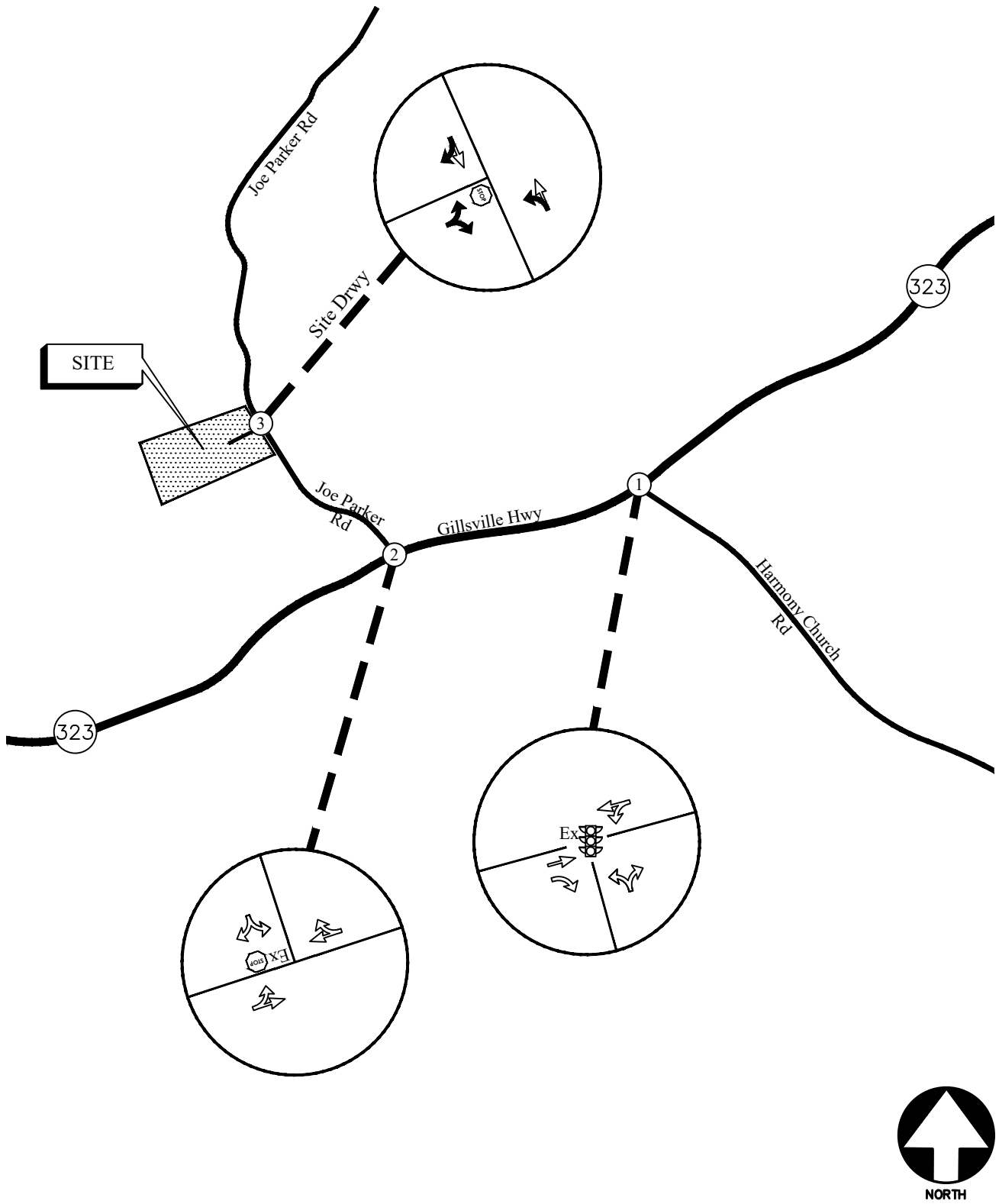

FUTURE TRAFFIC CONTROL AND LANE GEOMETRY

**FIGURE 8
A&R Engineering Inc.**

7.0 CONCLUSIONS AND RECOMMENDATIONS

Traffic impacts were evaluated for the proposed special events facility development that will be located west of Joe Parker Road in Hall County, Georgia. The development will consist of a special events facility with a 7,200 square foot building and a 103-vehicle space parking lot.

The development proposes one full access driveway on Joe Parker Road.

Existing and future operations after completion of the project were analyzed at the intersections of:

- SR 323 (Gillsville Highway) at Harmony Church Road
- SR 323 (Gillsville Highway) at Joe Parker Road
- Joe Parker Road at Proposed Site Driveway

The analysis included the evaluation of Future operations for “No-Build” and “Build” conditions, both of which account for increases in annual growth of through traffic. The results of future traffic operations analysis indicate that the signalized intersection 1 (SR 323 at Harmony Church Road) will continue to operate at a level of service “C” or better during the traffic peak hours, while the approaches at the unsignalized intersections will operate at level of service “C” or better in both the AM and PM peak hours. Based on the analysis, the proposed development will have minimal impact on traffic operations in the study network.

7.1 Recommendations for Site Access Configuration

The following access configuration is recommended for the proposed site driveway intersection.

- Site Driveway: Full access driveway on Joe Parker Road
 - One entering lane and one exiting lane
 - Stop-sign controlled on the driveway approach with Joe Parker Road remaining free flow
 - Provide adequate sight distance per AASHTO standards

Appendix

Existing Intersection Traffic Counts
Linear Regression of Daily Traffic.....
Existing Intersection Analysis.....
Future “No-Build” Intersection Analysis
Future “Build” Intersection Analysis.....
Traffic Volume Worksheets

EXISTING INTERSECTION TRAFFIC COUNTS

A & R Engineering, Inc.

2160 Kingston Court Suite 'O'
Marietta, GA 30067

TMC Data
Gillsville Hwy @ Harmony Church Rd
7-9 am | 4-6 pm

File Name : 20230052
Site Code : 20230052
Start Date : 3/8/2023
Page No : 1

Groups Printed- Cars, Buses & Trucks

Start Time	Harmony Church Rd Northbound				Southbound				Gillsville Hwy Eastbound				Gillsville Hwy Westbound				Int. Total
	Left	Thru	Right	App. Total	Left	Thru	Right	App. Total	Left	Thru	Right	App. Total	Left	Thru	Right	App. Total	
07:00 AM	75	0	15	90	0	0	0	0	0	21	28	49	8	25	0	33	172
07:15 AM	110	0	17	127	0	0	0	0	0	32	13	45	10	34	0	44	216
07:30 AM	115	0	17	132	0	0	0	0	0	49	16	65	8	49	0	57	254
07:45 AM	78	0	28	106	0	0	0	0	0	42	24	66	13	52	0	65	237
Total	378	0	77	455	0	0	0	0	0	144	81	225	39	160	0	199	879
08:00 AM	62	0	24	86	0	0	0	0	0	22	28	50	9	26	0	35	171
08:15 AM	64	0	6	70	0	0	0	0	0	33	25	58	10	65	0	75	203
08:30 AM	70	0	7	77	0	0	0	0	0	26	31	57	8	29	0	37	171
08:45 AM	51	0	4	55	0	0	0	0	0	18	26	44	7	21	0	28	127
Total	247	0	41	288	0	0	0	0	0	99	110	209	34	141	0	175	672
*** BREAK ***																	
04:00 PM	48	0	12	60	0	0	0	0	0	56	66	122	18	59	0	77	259
04:15 PM	68	0	13	81	0	0	0	0	0	98	78	176	13	95	0	108	365
04:30 PM	49	0	21	70	0	0	0	0	0	65	97	162	15	68	0	83	315
04:45 PM	67	0	14	81	0	0	0	0	0	68	85	153	9	32	0	41	275
Total	232	0	60	292	0	0	0	0	0	287	326	613	55	254	0	309	1214
05:00 PM	63	0	17	80	0	0	0	0	0	93	83	176	9	95	0	104	360
05:15 PM	62	0	21	83	0	0	0	0	0	79	86	165	10	79	0	89	337
05:30 PM	65	0	22	87	0	0	0	0	0	88	97	185	12	38	0	50	322
05:45 PM	76	0	19	95	0	0	0	0	0	72	87	159	17	72	0	89	343
Total	266	0	79	345	0	0	0	0	0	332	353	685	48	284	0	332	1362
Grand Total	1123	0	257	1380	0	0	0	0	0	862	870	1732	176	839	0	1015	4127
Apprch %	81.4	0	18.6		0	0	0		0	49.8	50.2		17.3	82.7	0		
Total %	27.2	0	6.2	33.4	0	0	0	0	0	20.9	21.1	42	4.3	20.3	0	24.6	

A & R Engineering, Inc.

2160 Kingston Court Suite 'O'
Marietta, GA 30067

TMC Data
Gillsville Hwy @ Harmony Church Rd
7-9 am | 4-6 pm

File Name : 20230052
Site Code : 20230052
Start Date : 3/8/2023
Page No : 2

	Harmony Church Rd Northbound				Southbound				Gillsville Hwy Eastbound				Gillsville Hwy Westbound				
Start Time	Left	Thru	Right	App. Total	Left	Thru	Right	App. Total	Left	Thru	Right	App. Total	Left	Thru	Right	App. Total	Int. Total
Peak Hour Analysis From 07:00 AM to 08:45 AM - Peak 1 of 1																	
Peak Hour for Entire Intersection Begins at 07:00 AM																	
07:00 AM	75	0	15	90	0	0	0	0	0	21	28	49	8	25	0	33	172
07:15 AM	110	0	17	127	0	0	0	0	0	32	13	45	10	34	0	44	216
07:30 AM	115	0	17	132	0	0	0	0	0	49	16	65	8	49	0	57	254
07:45 AM	78	0	28	106	0	0	0	0	0	42	24	66	13	52	0	65	237
Total Volume	378	0	77	455	0	0	0	0	0	144	81	225	39	160	0	199	879
% App. Total	83.1	0	16.9		0	0	0		0	64	36		19.6	80.4	0		
PHF	.822	.000	.688	.862	.000	.000	.000	.000	.000	.735	.723	.852	.750	.769	.000	.765	.865

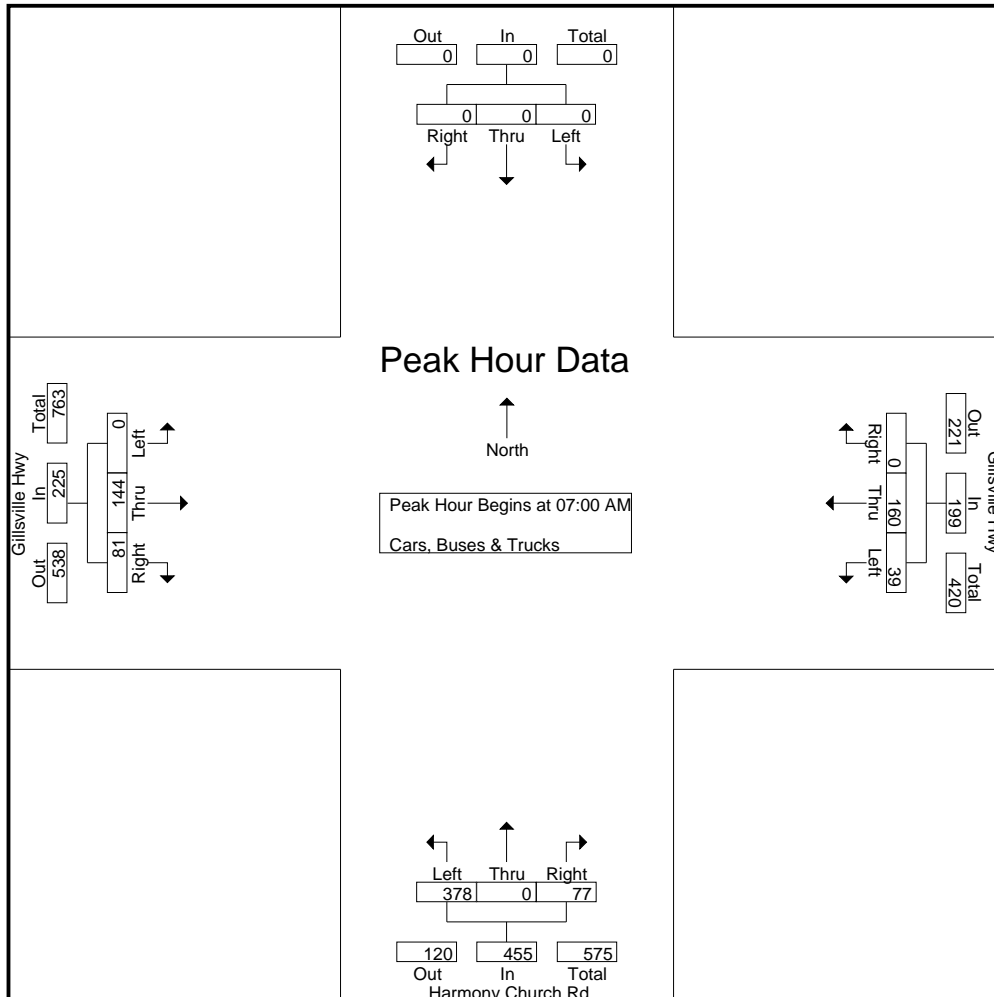

A & R Engineering, Inc.

2160 Kingston Court Suite 'O'
Marietta, GA 30067

TMC Data
Gillsville Hwy @ Harmony Church Rd
7-9 am | 4-6 pm

File Name : 20230052
Site Code : 20230052
Start Date : 3/8/2023
Page No : 3

Start Time	Harmony Church Rd Northbound				Southbound				Gillsville Hwy Eastbound				Gillsville Hwy Westbound				Int. Total
	Left	Thru	Right	App. Total	Left	Thru	Right	App. Total	Left	Thru	Right	App. Total	Left	Thru	Right	App. Total	
Peak Hour Analysis From 04:00 PM to 05:45 PM - Peak 1 of 1																	
Peak Hour for Entire Intersection Begins at 05:00 PM																	
05:00 PM	63	0	17	80	0	0	0	0	0	93	83	176	9	95	0	104	360
05:15 PM	62	0	21	83	0	0	0	0	0	79	86	165	10	79	0	89	337
05:30 PM	65	0	22	87	0	0	0	0	0	88	97	185	12	38	0	50	322
05:45 PM	76	0	19	95	0	0	0	0	0	72	87	159	17	72	0	89	343
Total Volume	266	0	79	345	0	0	0	0	0	332	353	685	48	284	0	332	1362
% App. Total	77.1	0	22.9		0	0	0		0	48.5	51.5		14.5	85.5	0		
PHF	.875	.000	.898	.908	.000	.000	.000	.000	.000	.892	.910	.926	.706	.747	.000	.798	.946

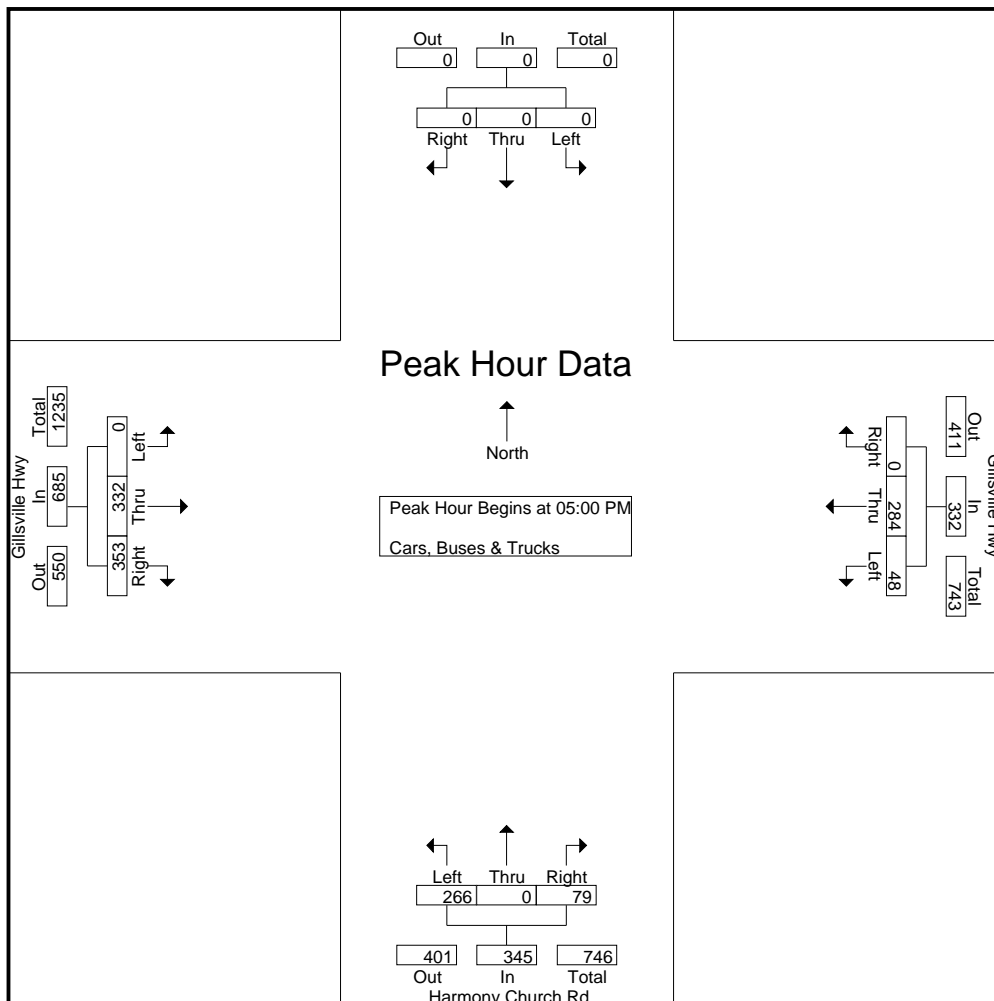

A & R Engineering, Inc.

2160 Kingston Court Suite 'O'
Marietta, GA 30067

TMC DATA
Gillsville Hwy @ Joe Parker Rd
7-9 am | 4-6 pm

File Name : 20230051
Site Code : 20230051
Start Date : 3/8/2023
Page No : 1

Groups Printed- Cars,Buses & Trucks

Start Time	Northbound				Joe Parker Rd Southbound				Gillsville Hwy Eastbound				Gillsville Hwy Westbound				Int. Total
	Left	Thru	Right	App. Total	Left	Thru	Right	App. Total	Left	Thru	Right	App. Total	Left	Thru	Right	App. Total	
07:00 AM	0	0	0	0	1	0	1	2	1	50	0	51	0	180	0	180	233
07:15 AM	0	0	0	0	1	0	3	4	1	48	0	49	0	205	3	208	261
07:30 AM	0	0	0	0	2	0	2	4	1	66	0	67	0	195	0	195	266
07:45 AM	0	0	0	0	0	0	0	0	1	66	0	67	0	128	0	128	195
Total	0	0	0	0	4	0	6	10	4	230	0	234	0	708	3	711	955
08:00 AM	0	0	0	0	1	0	1	2	0	47	0	47	0	112	0	112	161
08:15 AM	0	0	0	0	0	0	1	1	1	58	0	59	0	127	0	127	187
08:30 AM	0	0	0	0	1	0	1	2	1	57	0	58	0	92	0	92	152
08:45 AM	0	0	0	0	0	0	1	1	0	41	0	41	0	82	0	82	124
Total	0	0	0	0	2	0	4	6	2	203	0	205	0	413	0	413	624
*** BREAK ***																	
04:00 PM	0	0	0	0	1	0	2	3	3	118	0	121	0	105	2	107	231
04:15 PM	0	0	0	0	3	0	2	5	6	176	0	182	0	93	0	93	280
04:30 PM	0	0	0	0	0	0	2	2	0	160	0	160	0	95	2	97	259
04:45 PM	0	0	0	0	1	0	2	3	3	152	0	155	0	91	2	93	251
Total	0	0	0	0	5	0	8	13	12	606	0	618	0	384	6	390	1021
05:00 PM	0	0	0	0	2	0	3	5	1	176	0	177	0	109	2	111	293
05:15 PM	0	0	0	0	3	0	3	6	6	163	0	169	0	111	1	112	287
05:30 PM	0	0	0	0	3	0	1	4	2	182	0	184	0	102	1	103	291
05:45 PM	0	0	0	0	0	0	2	2	2	158	0	160	0	124	0	124	286
Total	0	0	0	0	8	0	9	17	11	679	0	690	0	446	4	450	1157
Grand Total	0	0	0	0	19	0	27	46	29	1718	0	1747	0	1951	13	1964	3757
Apprch %	0	0	0	0	41.3	0	58.7	46	1.7	98.3	0	1747	0	99.3	0.7	1964	3757
Total %	0	0	0	0	0.5	0	0.7	1.2	0.8	45.7	0	46.5	0	51.9	0.3	52.3	3757

A & R Engineering, Inc.

2160 Kingston Court Suite 'O'
Marietta, GA 30067

TMC DATA
Gillsville Hwy @ Joe Parker Rd
7-9 am | 4-6 pm

File Name : 20230051
Site Code : 20230051
Start Date : 3/8/2023
Page No : 2

Start Time	Northbound				Joe Parker Rd Southbound				Gillsville Hwy Eastbound				Gillsville Hwy Westbound				Int. Total
	Left	Thru	Right	App. Total	Left	Thru	Right	App. Total	Left	Thru	Right	App. Total	Left	Thru	Right	App. Total	
Peak Hour Analysis From 07:00 AM to 08:45 AM - Peak 1 of 1																	
Peak Hour for Entire Intersection Begins at 07:00 AM																	
07:00 AM	0	0	0	0	1	0	1	2	1	50	0	51	0	180	0	180	233
07:15 AM	0	0	0	0	1	0	3	4	1	48	0	49	0	205	3	208	261
07:30 AM	0	0	0	0	2	0	2	4	1	66	0	67	0	195	0	195	266
07:45 AM	0	0	0	0	0	0	0	0	1	66	0	67	0	128	0	128	195
Total Volume	0	0	0	0	4	0	6	10	4	230	0	234	0	708	3	711	955
% App. Total	0	0	0	0	40	0	60		1.7	98.3	0		0	99.6	0.4		
PHF	.000	.000	.000	.000	.500	.000	.500	.625	1.00	.871	.000	.873	.000	.863	.250	.855	.898

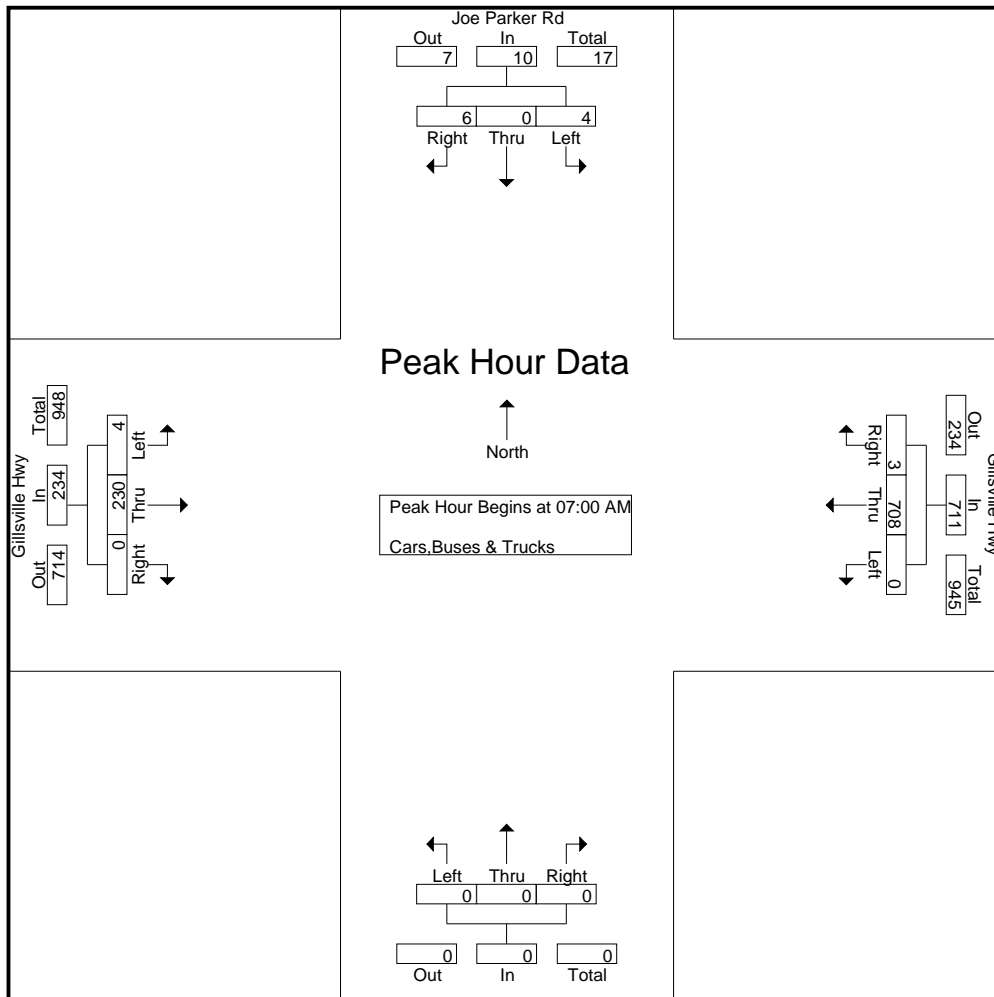

A & R Engineering, Inc.

2160 Kingston Court Suite 'O'
Marietta, GA 30067

TMC DATA
Gillsville Hwy @ Joe Parker Rd
7-9 am | 4-6 pm

File Name : 20230051
Site Code : 20230051
Start Date : 3/8/2023
Page No : 3

Start Time	Northbound				Joe Parker Rd Southbound				Gillsville Hwy Eastbound				Gillsville Hwy Westbound				Int. Total
	Left	Thru	Right	App. Total	Left	Thru	Right	App. Total	Left	Thru	Right	App. Total	Left	Thru	Right	App. Total	
Peak Hour Analysis From 04:00 PM to 05:45 PM - Peak 1 of 1																	
Peak Hour for Entire Intersection Begins at 05:00 PM																	
05:00 PM	0	0	0	0	2	0	3	5	1	176	0	177	0	109	2	111	293
05:15 PM	0	0	0	0	3	0	3	6	6	163	0	169	0	111	1	112	287
05:30 PM	0	0	0	0	3	0	1	4	2	182	0	184	0	102	1	103	291
05:45 PM	0	0	0	0	0	0	2	2	2	158	0	160	0	124	0	124	286
Total Volume	0	0	0	0	8	0	9	17	11	679	0	690	0	446	4	450	1157
% App. Total	0	0	0	0	47.1	0	52.9		1.6	98.4	0		0	99.1	0.9		
PHF	.000	.000	.000	.000	.667	.000	.750	.708	.458	.933	.000	.938	.000	.899	.500	.907	.987

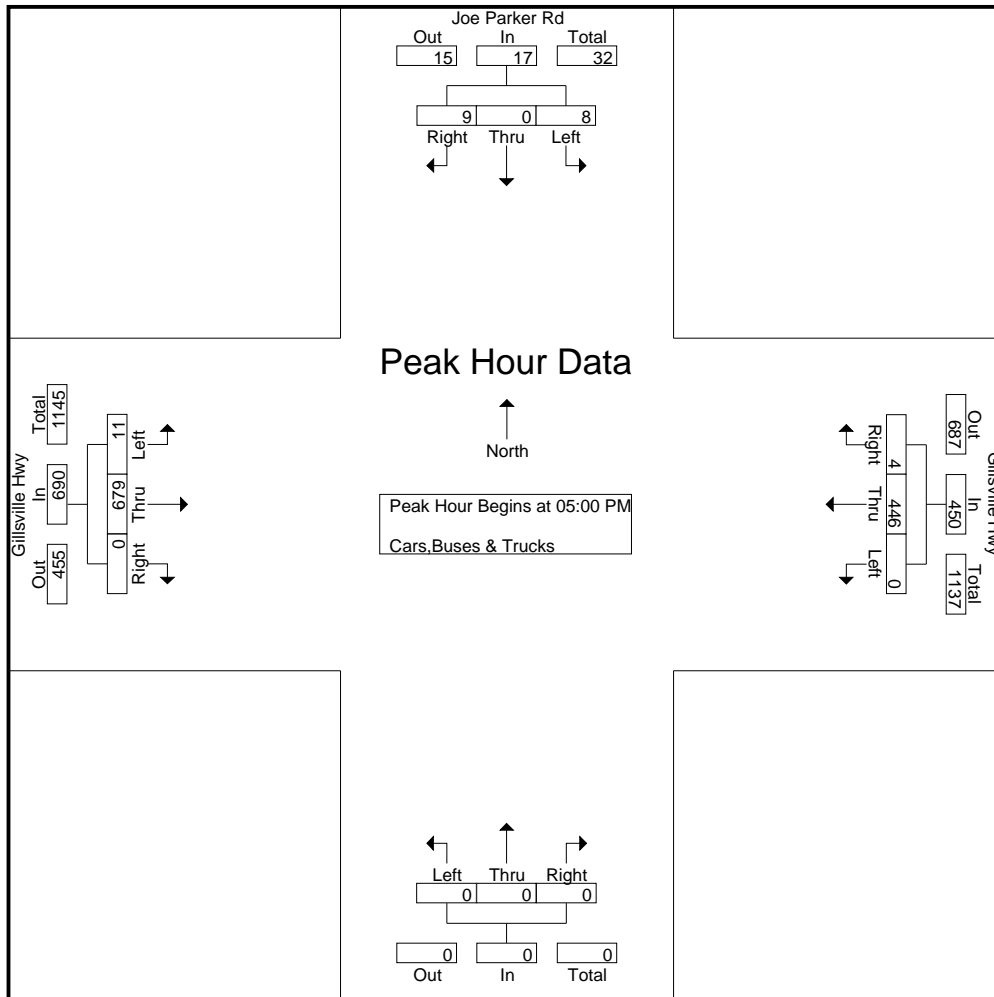

A & R Engineering, Inc.

2160 Kingston Court Suite 'O'
Marietta, GA 30067

TMC Data
Joe Parker Rd @ Proposed Site Driveway
Location
7-9 am | 4-6 pm

File Name : 20230050
Site Code : 20230050
Start Date : 03-07-2023
Page No : 1

Groups Printed- Cars, Buses & Trucks

Start Time	Jor Parker Rd Northbound				Jor Parker Rd Southbound				Eastbound				Westbound				Int. Total
	Left	Thru	Right	App. Total	Left	Thru	Right	App. Total	Left	Thru	Right	App. Total	Left	Thru	Right	App. Total	
07:00 AM	0	1	0	1	0	2	0	2	0	0	0	0	0	0	0	0	3
07:15 AM	0	3	0	3	0	3	0	3	0	0	0	0	0	0	0	0	6
07:30 AM	0	1	0	1	0	3	0	3	0	0	0	0	0	0	0	0	4
07:45 AM	0	1	0	1	0	0	0	0	0	0	0	0	0	0	0	0	1
Total	0	6	0	6	0	8	0	8	0	0	0	0	0	0	0	0	14
08:00 AM	0	0	0	0	0	2	0	2	0	0	0	0	0	0	0	0	2
08:15 AM	0	1	0	1	0	1	0	1	0	0	0	0	0	0	0	0	2
08:30 AM	0	1	0	1	0	2	0	2	0	0	0	0	0	0	0	0	3
08:45 AM	0	0	0	0	0	1	0	1	0	0	0	0	0	0	0	0	1
Total	0	2	0	2	0	6	0	6	0	0	0	0	0	0	0	0	8
*** BREAK ***																	
04:00 PM	0	5	0	5	0	3	0	3	0	0	0	0	0	0	0	0	8
04:15 PM	0	4	0	4	0	4	0	4	0	0	0	0	0	0	0	0	8
04:30 PM	0	2	0	2	0	2	0	2	0	0	0	0	0	0	0	0	4
04:45 PM	0	5	0	5	0	3	0	3	0	0	0	0	0	0	0	0	8
Total	0	16	0	16	0	12	0	12	0	0	0	0	0	0	0	0	28
05:00 PM	0	3	0	3	0	4	0	4	0	0	0	0	0	0	0	0	7
05:15 PM	0	5	0	5	0	5	0	5	0	0	0	0	0	0	0	0	10
05:30 PM	0	3	0	3	0	3	0	3	0	0	0	0	0	0	0	0	6
05:45 PM	0	2	0	2	0	2	0	2	0	0	0	0	0	0	0	0	4
Total	0	13	0	13	0	14	0	14	0	0	0	0	0	0	0	0	27
Grand Total	0	37	0	37	0	40	0	40	0	0	0	0	0	0	0	0	77
Apprch %	0	100	0		0	100	0		0	0	0		0	0	0		
Total %	0	48.1	0	48.1	0	51.9	0	51.9	0	0	0	0	0	0	0	0	

A & R Engineering, Inc.

2160 Kingston Court Suite 'O'
Marietta, GA 30067

TMC Data
Joe Parker Rd @ Proposed Site Driveway
Location
7-9 am | 4-6 pm

File Name : 20230050
Site Code : 20230050
Start Date : 03-07-2023
Page No : 2

Start Time	Jor Parker Rd Northbound				Jor Parker Rd Southbound				Eastbound				Westbound				Int. Total	
	Left	Thru	Right	App. Total	Left	Thru	Right	App. Total	Left	Thru	Right	App. Total	Left	Thru	Right	App. Total		
Peak Hour Analysis From 07:00 AM to 08:45 AM - Peak 1 of 1																		
Peak Hour for Entire Intersection Begins at 07:00 AM																		
07:00 AM	0	1	0	1	0	2	0	2	0	0	0	0	0	0	0	0	0	3
07:15 AM	0	3	0	3	0	3	0	3	0	0	0	0	0	0	0	0	0	6
07:30 AM	0	1	0	1	0	3	0	3	0	0	0	0	0	0	0	0	0	4
07:45 AM	0	1	0	1	0	0	0	0	0	0	0	0	0	0	0	0	0	1
Total Volume	0	6	0	6	0	8	0	8	0	0	0	0	0	0	0	0	0	14
% App. Total	0	100	0	.500	0	100	0	.667	0	0	0	0	0	0	0	0	0	.583
PHF	.000	.500	.000	.500	.000	.667	.000	.667	.000	.000	.000	.000	.000	.000	.000	.000	.000	.583

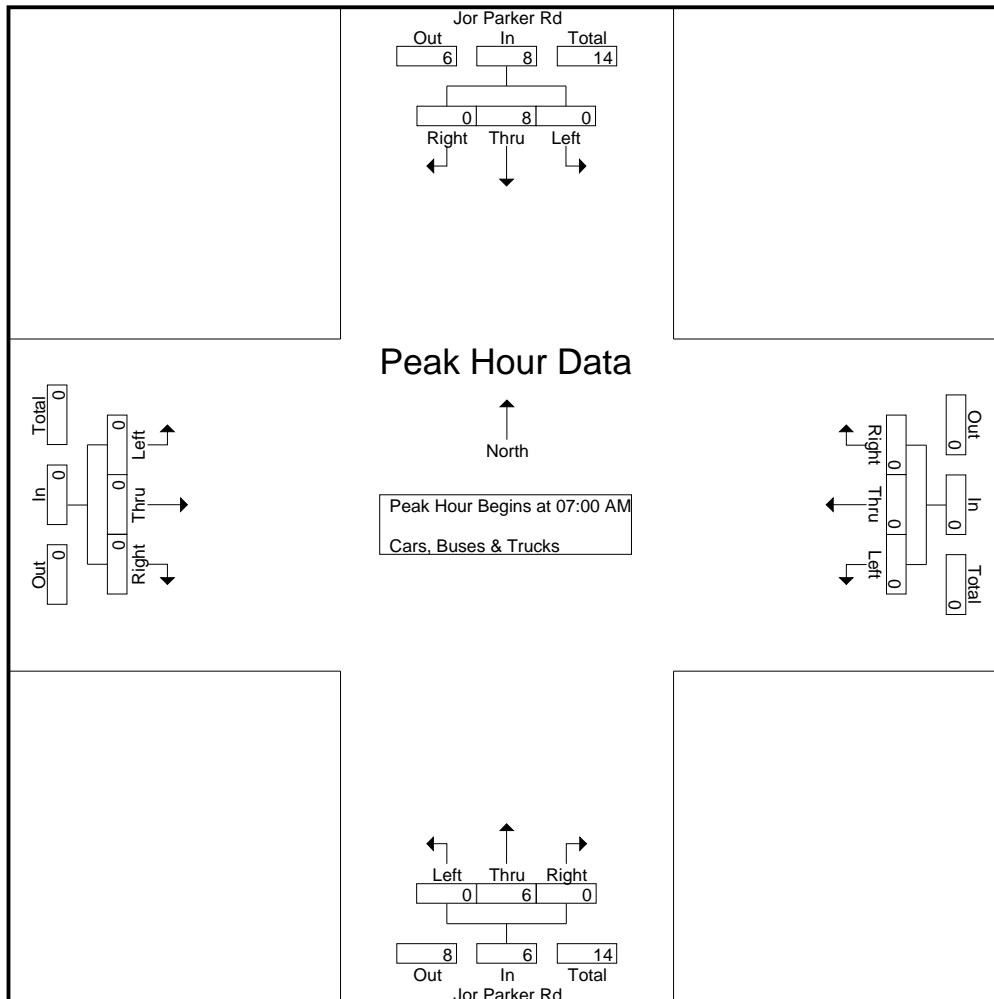

A & R Engineering, Inc.

2160 Kingston Court Suite 'O'
Marietta, GA 30067

TMC Data
Joe Parker Rd @ Proposed Site Driveway
Location
7-9 am | 4-6 pm

File Name : 20230050
Site Code : 20230050
Start Date : 03-07-2023
Page No : 3

Start Time	Jor Parker Rd Northbound				Jor Parker Rd Southbound				Eastbound				Westbound				Int. Total	
	Left	Thru	Right	App. Total	Left	Thru	Right	App. Total	Left	Thru	Right	App. Total	Left	Thru	Right	App. Total		
Peak Hour Analysis From 04:00 PM to 05:45 PM - Peak 1 of 1																		
Peak Hour for Entire Intersection Begins at 04:45 PM																		
04:45 PM	0	5	0	5	0	3	0	3	0	0	0	0	0	0	0	0	0	8
05:00 PM	0	3	0	3	0	4	0	4	0	0	0	0	0	0	0	0	0	7
05:15 PM	0	5	0	5	0	5	0	5	0	0	0	0	0	0	0	0	0	10
05:30 PM	0	3	0	3	0	3	0	3	0	0	0	0	0	0	0	0	0	6
Total Volume	0	16	0	16	0	15	0	15	0	0	0	0	0	0	0	0	0	31
% App. Total	0	100	0		0	100	0		0	0	0		0	0	0			
PHF	.000	.800	.000	.800	.000	.750	.000	.750	.000	.000	.000	.000	.000	.000	.000	.000	.000	.775

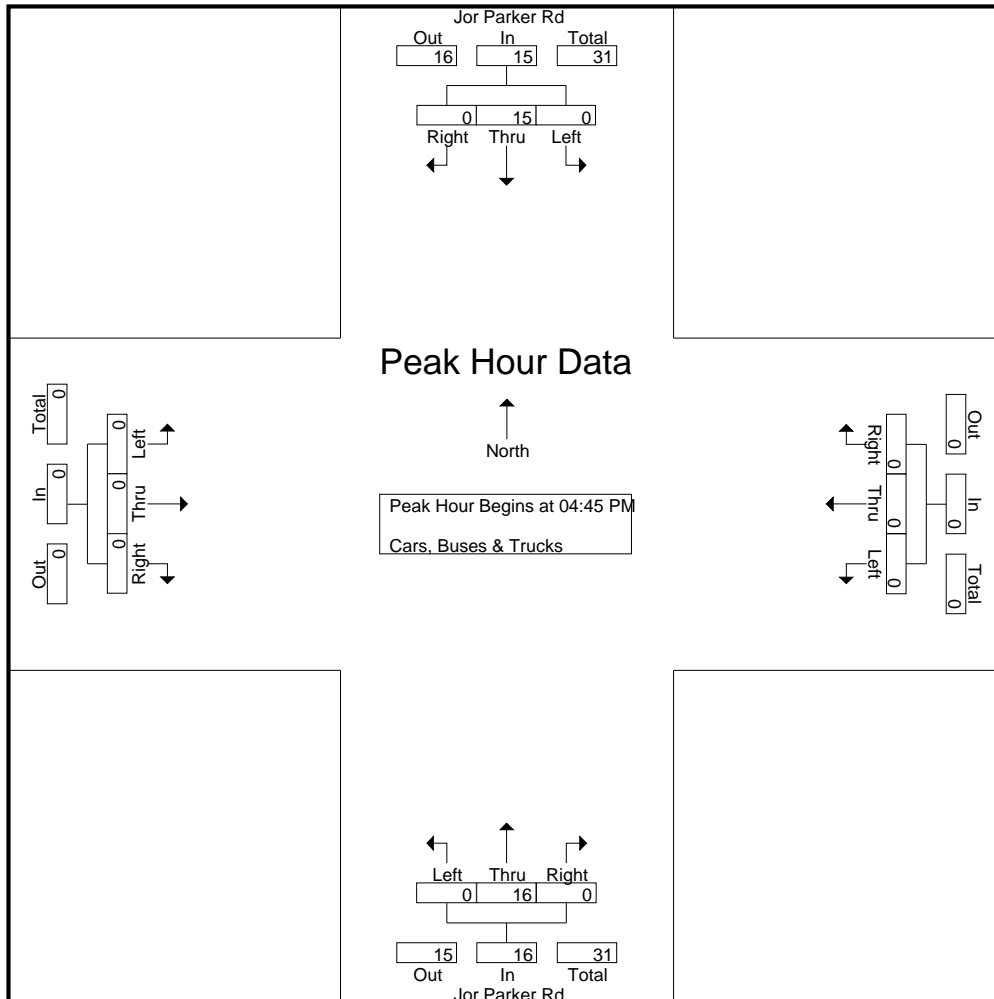

LINEAR REGRESSION OF DAILY TRAFFIC

Location	Growth Rate	R Squared	Station ID	Route	2017	2018	2019
SR 323 Gillsville Hwy (West of Joe Parker Rd)	4.0%	0.91	139-0387	00032300	11,000	11,200	11,900
SR 11 Athens Hwy (North of Gaines Mill Rd)	-3.4%	0.85	139-0116	00001100	33,800	33,500	31,500
SR 323 Gillsville Hwy (NE of SR 8)	4.7%	0.91	139-0389	00032300	3,120	3,350	3,420
EE Butler Pkwy (West of Athens)	4.5%	0.80	139-0118	00001100	30,300	32,900	33,100
Monroe Dr (Southwest of Allen Creek Rd)	1.8%	0.99	139-8071	00071907	1,960	1,990	2,030
Weighted Average	1.1%	0.40	Sum of Count Stations =		80,180	82,940	81,950

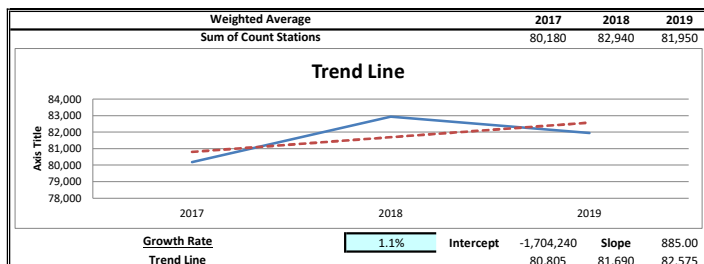
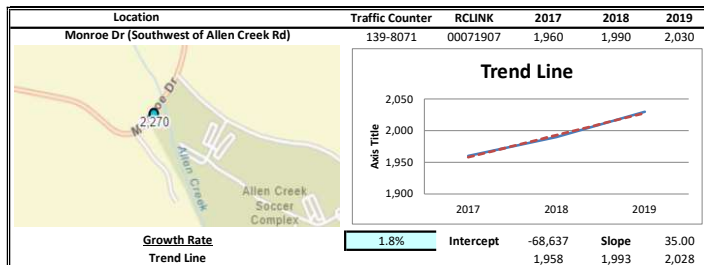
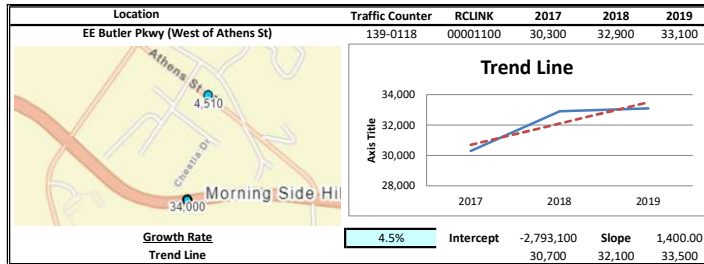
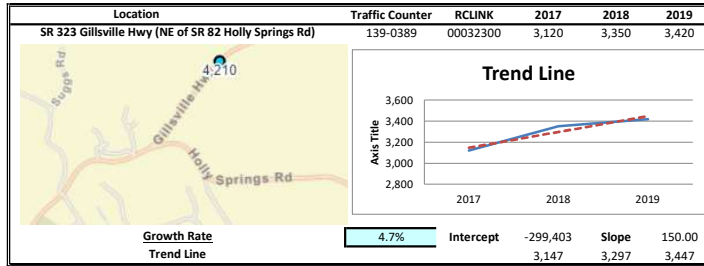
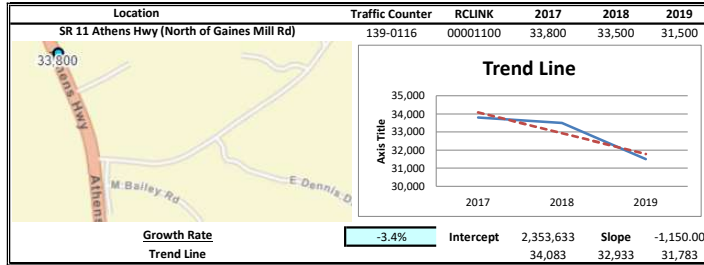
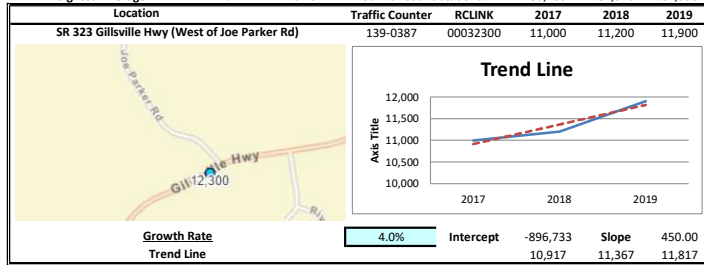

EXISTING INTERSECTION ANALYSIS

Timings
1: Harmony Church Rd & SR 323 (Gillsville Hwy)

1a. Existing AM
03/24/2023



Lane Group	EBT	EBR	WBL	WBT	NBL
Lane Configurations	↑	↗		↖	↘
Traffic Volume (vph)	144	81	39	160	378
Future Volume (vph)	144	81	39	160	378
Lane Group Flow (vph)	160	90	0	221	506
Turn Type	NA	Perm	Perm	NA	Prot
Protected Phases	6			2	3
Permitted Phases		6	2		
Detector Phase	6	6	2	2	3
Switch Phase					
Minimum Initial (s)	5.0	5.0	5.0	5.0	5.0
Minimum Split (s)	22.5	22.5	22.5	22.5	22.5
Total Split (s)	42.0	42.0	42.0	42.0	48.0
Total Split (%)	46.7%	46.7%	46.7%	46.7%	53.3%
Yellow Time (s)	3.5	3.5	3.5	3.5	3.5
All-Red Time (s)	1.0	1.0	1.0	1.0	1.0
Lost Time Adjust (s)	0.0	0.0		0.0	0.0
Total Lost Time (s)	4.5	4.5		4.5	4.5
Lead/Lag					
Lead-Lag Optimize?					
Recall Mode	C-Min	C-Min	C-Min	C-Min	Min
v/c Ratio	0.16	0.10		0.24	0.81
Control Delay	12.5	4.7		13.2	35.1
Queue Delay	0.0	0.0		0.0	0.0
Total Delay	12.5	4.7		13.2	35.1
Queue Length 50th (ft)	45	4		64	257
Queue Length 95th (ft)	97	32		134	325
Internal Link Dist (ft)	1795			886	696
Turn Bay Length (ft)		25			
Base Capacity (vph)	1017	898		940	852
Starvation Cap Reductn	0	0		0	0
Spillback Cap Reductn	0	0		0	0
Storage Cap Reductn	0	0		0	0
Reduced v/c Ratio	0.16	0.10		0.24	0.59

Intersection Summary

Cycle Length: 90
 Actuated Cycle Length: 90
 Offset: 0 (0%), Referenced to phase 2:WBTL and 6:EBT, Start of Green
 Natural Cycle: 50
 Control Type: Actuated-Coordinated

Splits and Phases: 1: Harmony Church Rd & SR 323 (Gillsville Hwy)

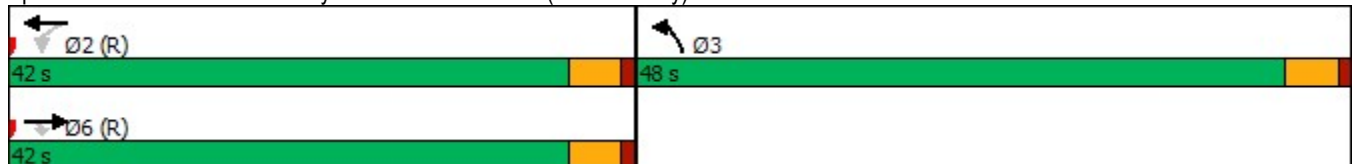

HCM 6th Signalized Intersection Summary
 1: Harmony Church Rd & SR 323 (Gillsville Hwy)

1a. Existing AM
 03/24/2023

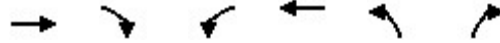

Movement	EBT	EBR	WBL	WBT	NBL	NBR
Lane Configurations	↑	↑		↑	↑	
Traffic Volume (veh/h)	144	81	39	160	378	77
Future Volume (veh/h)	144	81	39	160	378	77
Initial Q (Qb), veh	0	0	0	0	0	0
Ped-Bike Adj(A_pbT)		1.00	1.00		1.00	1.00
Parking Bus, Adj	1.00	1.00	1.00	1.00	1.00	1.00
Work Zone On Approach	No			No	No	
Adj Sat Flow, veh/h/ln	1870	1870	1870	1870	1870	1870
Adj Flow Rate, veh/h	160	90	43	178	420	86
Peak Hour Factor	0.90	0.90	0.90	0.90	0.90	0.90
Percent Heavy Veh, %	2	2	2	2	2	2
Cap, veh/h	1089	923	206	827	460	94
Arrive On Green	0.58	0.58	0.58	0.58	0.32	0.32
Sat Flow, veh/h	1870	1585	272	1420	1445	296
Grp Volume(v), veh/h	160	90	221	0	507	0
Grp Sat Flow(s),veh/h/ln	1870	1585	1692	0	1745	0
Q Serve(g_s), s	3.5	2.3	0.0	0.0	25.1	0.0
Cycle Q Clear(g_c), s	3.5	2.3	5.0	0.0	25.1	0.0
Prop In Lane		1.00	0.19		0.83	0.17
Lane Grp Cap(c), veh/h	1089	923	1033	0	555	0
V/C Ratio(X)	0.15	0.10	0.21	0.00	0.91	0.00
Avail Cap(c_a), veh/h	1089	923	1033	0	843	0
HCM Platoon Ratio	1.00	1.00	1.00	1.00	1.00	1.00
Upstream Filter(l)	1.00	1.00	1.00	0.00	1.00	0.00
Uniform Delay (d), s/veh	8.6	8.3	8.9	0.0	29.5	0.0
Incr Delay (d2), s/veh	0.3	0.2	0.5	0.0	10.2	0.0
Initial Q Delay(d3),s/veh	0.0	0.0	0.0	0.0	0.0	0.0
%ile BackOfQ(50%),veh/ln	1.3	0.7	1.9	0.0	11.0	0.0
Unsig. Movement Delay, s/veh						
LnGrp Delay(d),s/veh	8.9	8.5	9.4	0.0	39.7	0.0
LnGrp LOS	A	A	A	A	D	A
Approach Vol, veh/h	250			221	507	
Approach Delay, s/veh	8.8			9.4	39.7	
Approach LOS	A			A	D	
Timer - Assigned Phs		2			6	8
Phs Duration (G+Y+Rc), s		56.9			56.9	33.1
Change Period (Y+Rc), s		4.5			4.5	4.5
Max Green Setting (Gmax), s		37.5			37.5	43.5
Max Q Clear Time (g_c+I1), s		7.0			5.5	27.1
Green Ext Time (p_c), s		1.3			1.1	1.5

Intersection Summary

HCM 6th Ctrl Delay	25.0
HCM 6th LOS	C

Notes

User approved volume balancing among the lanes for turning movement.

Intersection						
Int Delay, s/veh	0.2					
Movement	EBL	EBT	WBT	WBR	SBL	SBR
Lane Configurations		↶	↷		↶	↷
Traffic Vol, veh/h	4	230	708	3	4	6
Future Vol, veh/h	4	230	708	3	4	6
Conflicting Peds, #/hr	0	0	0	0	0	0
Sign Control	Free	Free	Free	Free	Stop	Stop
RT Channelized	-	None	-	None	-	None
Storage Length	-	-	-	-	0	-
Veh in Median Storage, #	-	0	0	-	0	-
Grade, %	-	0	0	-	0	-
Peak Hour Factor	90	90	90	90	90	90
Heavy Vehicles, %	2	2	2	2	2	2
Mvmt Flow	4	256	787	3	4	7

Major/Minor	Major1	Major2	Minor2		
Conflicting Flow All	790	0	-	0	1053 789
Stage 1	-	-	-	-	789 -
Stage 2	-	-	-	-	264 -
Critical Hdwy	4.12	-	-	-	6.42 6.22
Critical Hdwy Stg 1	-	-	-	-	5.42 -
Critical Hdwy Stg 2	-	-	-	-	5.42 -
Follow-up Hdwy	2.218	-	-	-	3.518 3.318
Pot Cap-1 Maneuver	830	-	-	-	251 391
Stage 1	-	-	-	-	448 -
Stage 2	-	-	-	-	780 -
Platoon blocked, %		-	-	-	
Mov Cap-1 Maneuver	830	-	-	-	249 391
Mov Cap-2 Maneuver	-	-	-	-	249 -
Stage 1	-	-	-	-	445 -
Stage 2	-	-	-	-	780 -

Approach	EB	WB	SB
HCM Control Delay, s	0.2	0	16.7
HCM LOS			C

Minor Lane/Major Mvmt	EBL	EBT	WBT	WBR	SBLn1
Capacity (veh/h)	830	-	-	-	318
HCM Lane V/C Ratio	0.005	-	-	-	0.035
HCM Control Delay (s)	9.4	0	-	-	16.7
HCM Lane LOS	A	A	-	-	C
HCM 95th %tile Q(veh)	0	-	-	-	0.1

Timings
 1: Harmony Church Rd & SR 323 (Gillsville Hwy)

1b. Existing PM
 03/24/2023



Lane Group	EBT	EBR	WBL	WBT	NBL
Lane Configurations	↑	↑		↑	↑
Traffic Volume (vph)	332	353	48	284	266
Future Volume (vph)	332	353	48	284	266
Lane Group Flow (vph)	349	372	0	350	363
Turn Type	NA	Perm	Perm	NA	Prot
Protected Phases	6			2	3
Permitted Phases		6	2		
Detector Phase	6	6	2	2	3
Switch Phase					
Minimum Initial (s)	5.0	5.0	5.0	5.0	5.0
Minimum Split (s)	22.5	22.5	22.5	22.5	22.5
Total Split (s)	49.0	49.0	44.0	44.0	41.0
Total Split (%)	54.4%	54.4%	48.9%	48.9%	45.6%
Yellow Time (s)	3.5	3.5	3.5	3.5	3.5
All-Red Time (s)	1.0	1.0	1.0	1.0	1.0
Lost Time Adjust (s)	0.0	0.0		0.0	0.0
Total Lost Time (s)	4.5	4.5		4.5	4.5
Lead/Lag					
Lead-Lag Optimize?					
Recall Mode	C-Max	C-Max	C-Min	C-Min	Min
v/c Ratio	0.29	0.35		0.32	0.77
Control Delay	9.2	5.9		9.6	39.8
Queue Delay	0.0	0.0		0.0	0.0
Total Delay	9.2	5.9		9.6	39.8
Queue Length 50th (ft)	83	46		85	188
Queue Length 95th (ft)	166	120		173	258
Internal Link Dist (ft)	1795			886	696
Turn Bay Length (ft)		25			
Base Capacity (vph)	1188	1069		1082	716
Starvation Cap Reductn	0	0		0	0
Spillback Cap Reductn	0	0		0	0
Storage Cap Reductn	0	0		0	0
Reduced v/c Ratio	0.29	0.35		0.32	0.51

Intersection Summary

Cycle Length: 90
 Actuated Cycle Length: 90
 Offset: 0 (0%), Referenced to phase 2:WBTL and 6:EBT, Start of Green
 Natural Cycle: 45
 Control Type: Actuated-Coordinated

Splits and Phases: 1: Harmony Church Rd & SR 323 (Gillsville Hwy)

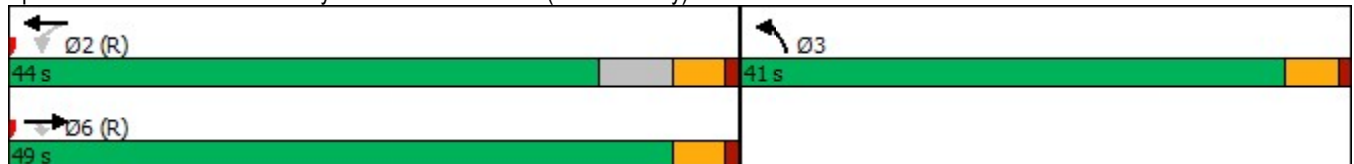

HCM 6th Signalized Intersection Summary
 1: Harmony Church Rd & SR 323 (Gillsville Hwy)

1b. Existing PM
 03/24/2023

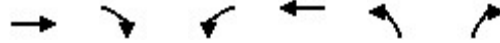

Movement	EBT	EBR	WBL	WBT	NBL	NBR
Lane Configurations	↑	↑		↑	↑	
Traffic Volume (veh/h)	332	353	48	284	266	79
Future Volume (veh/h)	332	353	48	284	266	79
Initial Q (Qb), veh	0	0	0	0	0	0
Ped-Bike Adj(A_pbT)		1.00	1.00		1.00	1.00
Parking Bus, Adj	1.00	1.00	1.00	1.00	1.00	1.00
Work Zone On Approach	No			No	No	
Adj Sat Flow, veh/h/ln	1870	1870	1870	1870	1870	1870
Adj Flow Rate, veh/h	349	372	51	299	280	83
Peak Hour Factor	0.95	0.95	0.95	0.95	0.95	0.95
Percent Heavy Veh, %	2	2	2	2	2	2
Cap, veh/h	1241	1052	165	938	315	93
Arrive On Green	0.66	0.66	0.66	0.66	0.24	0.24
Sat Flow, veh/h	1870	1585	179	1413	1333	395
Grp Volume(v), veh/h	349	372	350	0	364	0
Grp Sat Flow(s),veh/h/ln	1870	1585	1592	0	1733	0
Q Serve(g_s), s	6.9	9.3	0.0	0.0	18.3	0.0
Cycle Q Clear(g_c), s	6.9	9.3	7.0	0.0	18.3	0.0
Prop In Lane		1.00	0.15		0.77	0.23
Lane Grp Cap(c), veh/h	1241	1052	1102	0	409	0
V/C Ratio(X)	0.28	0.35	0.32	0.00	0.89	0.00
Avail Cap(c_a), veh/h	1241	1052	1102	0	703	0
HCM Platoon Ratio	1.00	1.00	1.00	1.00	1.00	1.00
Upstream Filter(l)	1.00	1.00	1.00	0.00	1.00	0.00
Uniform Delay (d), s/veh	6.3	6.6	6.3	0.0	33.2	0.0
Incr Delay (d2), s/veh	0.6	0.9	0.8	0.0	7.5	0.0
Initial Q Delay(d3),s/veh	0.0	0.0	0.0	0.0	0.0	0.0
%ile BackOfQ(50%),veh/ln	2.3	2.6	2.3	0.0	7.9	0.0
Unsig. Movement Delay, s/veh						
LnGrp Delay(d),s/veh	6.8	7.6	7.0	0.0	40.7	0.0
LnGrp LOS	A	A	A	A	D	A
Approach Vol, veh/h	721			350	364	
Approach Delay, s/veh	7.2			7.0	40.7	
Approach LOS	A			A	D	
Timer - Assigned Phs		2			6	8
Phs Duration (G+Y+Rc), s		64.2			64.2	25.8
Change Period (Y+Rc), s		4.5			4.5	4.5
Max Green Setting (Gmax), s		39.5			44.5	36.5
Max Q Clear Time (g_c+I1), s		9.0			11.3	20.3
Green Ext Time (p_c), s		2.3			3.4	1.0

Intersection Summary

HCM 6th Ctrl Delay	15.7
HCM 6th LOS	B

Notes

User approved volume balancing among the lanes for turning movement.

Intersection						
Int Delay, s/veh	0.3					
Movement	EBL	EBT	WBT	WBR	SBL	SBR
Lane Configurations		↕	↕		↕	
Traffic Vol, veh/h	11	679	446	4	8	9
Future Vol, veh/h	11	679	446	4	8	9
Conflicting Peds, #/hr	0	0	0	0	0	0
Sign Control	Free	Free	Free	Free	Stop	Stop
RT Channelized	-	None	-	None	-	None
Storage Length	-	-	-	-	0	-
Veh in Median Storage, #	-	0	0	-	0	-
Grade, %	-	0	0	-	0	-
Peak Hour Factor	99	99	99	99	99	99
Heavy Vehicles, %	2	2	2	2	2	2
Mvmt Flow	11	686	451	4	8	9

Major/Minor	Major1	Major2	Minor2		
Conflicting Flow All	455	0	-	0	1161 453
Stage 1	-	-	-	-	453 -
Stage 2	-	-	-	-	708 -
Critical Hdwy	4.12	-	-	-	6.42 6.22
Critical Hdwy Stg 1	-	-	-	-	5.42 -
Critical Hdwy Stg 2	-	-	-	-	5.42 -
Follow-up Hdwy	2.218	-	-	-	3.518 3.318
Pot Cap-1 Maneuver	1106	-	-	-	216 607
Stage 1	-	-	-	-	640 -
Stage 2	-	-	-	-	488 -
Platoon blocked, %		-	-	-	
Mov Cap-1 Maneuver	1106	-	-	-	213 607
Mov Cap-2 Maneuver	-	-	-	-	213 -
Stage 1	-	-	-	-	630 -
Stage 2	-	-	-	-	488 -

Approach	EB	WB	SB
HCM Control Delay, s	0.1	0	16.7
HCM LOS			C

Minor Lane/Major Mvmt	EBL	EBT	WBT	WBR	SBLn1
Capacity (veh/h)	1106	-	-	-	325
HCM Lane V/C Ratio	0.01	-	-	-	0.053
HCM Control Delay (s)	8.3	0	-	-	16.7
HCM Lane LOS	A	A	-	-	C
HCM 95th %tile Q(veh)	0	-	-	-	0.2

**FUTURE “NO-BUILD” INTERSECTION
ANALYSIS**

Timings
1: Harmony Church Rd & SR 323 (Gillsville Hwy)

2a. No Build AM
03/24/2023



Lane Group	EBT	EBR	WBL	WBT	NBL
Lane Configurations	↑	↗		↖	↘
Traffic Volume (vph)	147	83	40	163	386
Future Volume (vph)	147	83	40	163	386
Lane Group Flow (vph)	171	97	0	237	541
Turn Type	NA	Perm	Perm	NA	Prot
Protected Phases	6			2	3
Permitted Phases		6	2		
Detector Phase	6	6	2	2	3
Switch Phase					
Minimum Initial (s)	5.0	5.0	5.0	5.0	5.0
Minimum Split (s)	22.5	22.5	22.5	22.5	22.5
Total Split (s)	42.0	42.0	42.0	42.0	48.0
Total Split (%)	46.7%	46.7%	46.7%	46.7%	53.3%
Yellow Time (s)	3.5	3.5	3.5	3.5	3.5
All-Red Time (s)	1.0	1.0	1.0	1.0	1.0
Lost Time Adjust (s)	0.0	0.0		0.0	0.0
Total Lost Time (s)	4.5	4.5		4.5	4.5
Lead/Lag					
Lead-Lag Optimize?					
Recall Mode	None	None	C-Min	C-Min	Min
v/c Ratio	0.17	0.11		0.26	0.82
Control Delay	13.5	5.4		14.4	34.7
Queue Delay	0.0	0.0		0.0	0.0
Total Delay	13.5	5.4		14.4	34.7
Queue Length 50th (ft)	51	6		74	273
Queue Length 95th (ft)	101	33		140	320
Internal Link Dist (ft)	1795			886	696
Turn Bay Length (ft)		25			
Base Capacity (vph)	981	870		902	852
Starvation Cap Reductn	0	0		0	0
Spillback Cap Reductn	0	0		0	0
Storage Cap Reductn	0	0		0	0
Reduced v/c Ratio	0.17	0.11		0.26	0.63

Intersection Summary

Cycle Length: 90
 Actuated Cycle Length: 90
 Offset: 0 (0%), Referenced to phase 2:WBTL, Start of Green
 Natural Cycle: 50
 Control Type: Actuated-Coordinated

Splits and Phases: 1: Harmony Church Rd & SR 323 (Gillsville Hwy)

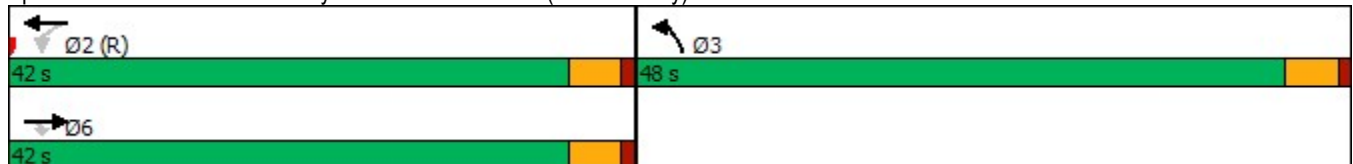

HCM 6th Signalized Intersection Summary
 1: Harmony Church Rd & SR 323 (Gillsville Hwy)

2a. No Build AM
 03/24/2023

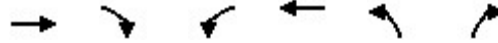

Movement	EBT	EBR	WBL	WBT	NBL	NBR
Lane Configurations	↑	↗		↑	↖	
Traffic Volume (veh/h)	147	83	40	163	386	79
Future Volume (veh/h)	147	83	40	163	386	79
Initial Q (Qb), veh	0	0	0	0	0	0
Ped-Bike Adj(A_pbT)		1.00	1.00		1.00	1.00
Parking Bus, Adj	1.00	1.00	1.00	1.00	1.00	1.00
Work Zone On Approach	No			No	No	
Adj Sat Flow, veh/h/ln	1870	1870	1870	1870	1870	1870
Adj Flow Rate, veh/h	171	97	47	190	449	92
Peak Hour Factor	0.86	0.86	0.86	0.86	0.86	0.86
Percent Heavy Veh, %	2	2	2	2	2	2
Cap, veh/h	1051	891	202	792	488	100
Arrive On Green	0.56	0.56	0.56	0.56	0.34	0.34
Sat Flow, veh/h	1870	1585	275	1408	1445	296
Grp Volume(v), veh/h	171	97	237	0	542	0
Grp Sat Flow(s),veh/h/ln	1870	1585	1683	0	1745	0
Q Serve(g_s), s	4.0	2.6	0.0	0.0	26.9	0.0
Cycle Q Clear(g_c), s	4.0	2.6	5.7	0.0	26.9	0.0
Prop In Lane		1.00	0.20		0.83	0.17
Lane Grp Cap(c), veh/h	1051	891	994	0	589	0
V/C Ratio(X)	0.16	0.11	0.24	0.00	0.92	0.00
Avail Cap(c_a), veh/h	1051	891	994	0	843	0
HCM Platoon Ratio	1.00	1.00	1.00	1.00	1.00	1.00
Upstream Filter(I)	1.00	1.00	1.00	0.00	1.00	0.00
Uniform Delay (d), s/veh	9.5	9.2	9.9	0.0	28.6	0.0
Incr Delay (d2), s/veh	0.1	0.1	0.6	0.0	11.6	0.0
Initial Q Delay(d3),s/veh	0.0	0.0	0.0	0.0	0.0	0.0
%ile BackOfQ(50%),veh/ln	1.4	0.8	2.2	0.0	11.9	0.0
Unsig. Movement Delay, s/veh						
LnGrp Delay(d),s/veh	9.6	9.2	10.4	0.0	40.2	0.0
LnGrp LOS	A	A	B	A	D	A
Approach Vol, veh/h	268			237	542	
Approach Delay, s/veh	9.4			10.4	40.2	
Approach LOS	A			B	D	
Timer - Assigned Phs		2			6	8
Phs Duration (G+Y+Rc), s		55.1			55.1	34.9
Change Period (Y+Rc), s		4.5			4.5	4.5
Max Green Setting (Gmax), s		37.5			37.5	43.5
Max Q Clear Time (g_c+I1), s		7.7			6.0	28.9
Green Ext Time (p_c), s		1.3			1.2	1.6

Intersection Summary

HCM 6th Ctrl Delay	25.6
HCM 6th LOS	C

Notes

User approved volume balancing among the lanes for turning movement.

Intersection						
Int Delay, s/veh	0.2					
Movement	EBL	EBT	WBT	WBR	SBL	SBR
Lane Configurations		↶	↷		↶	↷
Traffic Vol, veh/h	4	235	722	3	4	6
Future Vol, veh/h	4	235	722	3	4	6
Conflicting Peds, #/hr	0	0	0	0	0	0
Sign Control	Free	Free	Free	Free	Stop	Stop
RT Channelized	-	None	-	None	-	None
Storage Length	-	-	-	-	0	-
Veh in Median Storage, #	-	0	0	-	0	-
Grade, %	-	0	0	-	0	-
Peak Hour Factor	90	90	90	90	90	90
Heavy Vehicles, %	2	2	2	2	2	2
Mvmt Flow	4	261	802	3	4	7

Major/Minor	Major1	Major2	Minor2		
Conflicting Flow All	805	0	-	0	1073 804
Stage 1	-	-	-	-	804 -
Stage 2	-	-	-	-	269 -
Critical Hdwy	4.12	-	-	-	6.42 6.22
Critical Hdwy Stg 1	-	-	-	-	5.42 -
Critical Hdwy Stg 2	-	-	-	-	5.42 -
Follow-up Hdwy	2.218	-	-	-	3.518 3.318
Pot Cap-1 Maneuver	819	-	-	-	244 383
Stage 1	-	-	-	-	440 -
Stage 2	-	-	-	-	776 -
Platoon blocked, %		-	-	-	
Mov Cap-1 Maneuver	819	-	-	-	243 383
Mov Cap-2 Maneuver	-	-	-	-	243 -
Stage 1	-	-	-	-	437 -
Stage 2	-	-	-	-	776 -

Approach	EB	WB	SB
HCM Control Delay, s	0.2	0	17
HCM LOS			C

Minor Lane/Major Mvmt	EBL	EBT	WBT	WBR	SBLn1
Capacity (veh/h)	819	-	-	-	311
HCM Lane V/C Ratio	0.005	-	-	-	0.036
HCM Control Delay (s)	9.4	0	-	-	17
HCM Lane LOS	A	A	-	-	C
HCM 95th %tile Q(veh)	0	-	-	-	0.1

Timings
 1: Harmony Church Rd & SR 323 (Gillsville Hwy)

2b. No Build PM
 03/24/2023



Lane Group	EBT	EBR	WBL	WBT	NBL
Lane Configurations	↑	↑		↑	↑
Traffic Volume (vph)	339	360	49	290	271
Future Volume (vph)	339	360	49	290	271
Lane Group Flow (vph)	357	379	0	357	370
Turn Type	NA	Perm	Perm	NA	Prot
Protected Phases	6			2	3
Permitted Phases		6	2		
Detector Phase	6	6	2	2	3
Switch Phase					
Minimum Initial (s)	5.0	5.0	5.0	5.0	5.0
Minimum Split (s)	22.5	22.5	22.5	22.5	22.5
Total Split (s)	50.0	50.0	44.0	44.0	40.0
Total Split (%)	55.6%	55.6%	48.9%	48.9%	44.4%
Yellow Time (s)	3.5	3.5	3.5	3.5	3.5
All-Red Time (s)	1.0	1.0	1.0	1.0	1.0
Lost Time Adjust (s)	0.0	0.0		0.0	0.0
Total Lost Time (s)	4.5	4.5		4.5	4.5
Lead/Lag					
Lead-Lag Optimize?					
Recall Mode	None	None	C-Min	C-Min	Min
v/c Ratio	0.30	0.36		0.33	0.78
Control Delay	9.4	6.0		9.9	39.8
Queue Delay	0.0	0.0		0.0	0.0
Total Delay	9.4	6.0		9.9	39.8
Queue Length 50th (ft)	86	47		88	192
Queue Length 95th (ft)	172	124		178	262
Internal Link Dist (ft)	1795			886	696
Turn Bay Length (ft)		25			
Base Capacity (vph)	1181	1065		1074	697
Starvation Cap Reductn	0	0		0	0
Spillback Cap Reductn	0	0		0	0
Storage Cap Reductn	0	0		0	0
Reduced v/c Ratio	0.30	0.36		0.33	0.53

Intersection Summary

Cycle Length: 90
 Actuated Cycle Length: 90
 Offset: 44 (49%), Referenced to phase 2:WBTL, Start of Green
 Natural Cycle: 45
 Control Type: Actuated-Coordinated

Splits and Phases: 1: Harmony Church Rd & SR 323 (Gillsville Hwy)

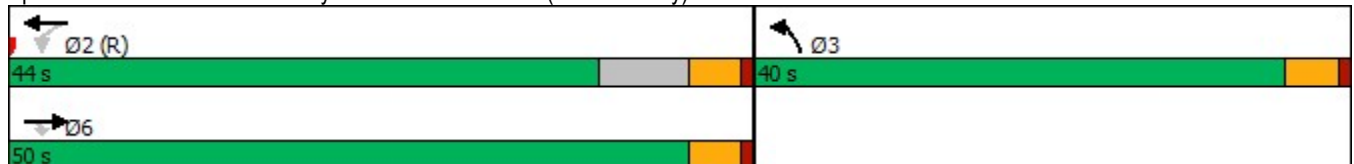

HCM 6th Signalized Intersection Summary
 1: Harmony Church Rd & SR 323 (Gillsville Hwy)

2b. No Build PM
 03/24/2023



Movement	EBT	EBR	WBL	WBT	NBL	NBR
Lane Configurations	↑	↗		↖	↖	↗
Traffic Volume (veh/h)	339	360	49	290	271	81
Future Volume (veh/h)	339	360	49	290	271	81
Initial Q (Qb), veh	0	0	0	0	0	0
Ped-Bike Adj(A_pbT)		1.00	1.00		1.00	1.00
Parking Bus, Adj	1.00	1.00	1.00	1.00	1.00	1.00
Work Zone On Approach	No			No	No	
Adj Sat Flow, veh/h/ln	1870	1870	1870	1870	1870	1870
Adj Flow Rate, veh/h	357	379	52	305	285	85
Peak Hour Factor	0.95	0.95	0.95	0.95	0.95	0.95
Percent Heavy Veh, %	2	2	2	2	2	2
Cap, veh/h	1234	1046	163	930	320	95
Arrive On Green	0.66	0.66	0.66	0.66	0.24	0.24
Sat Flow, veh/h	1870	1585	178	1409	1331	397
Grp Volume(v), veh/h	357	379	357	0	371	0
Grp Sat Flow(s),veh/h/ln	1870	1585	1587	0	1732	0
Q Serve(g_s), s	7.2	9.6	0.0	0.0	18.6	0.0
Cycle Q Clear(g_c), s	7.2	9.6	7.2	0.0	18.6	0.0
Prop In Lane		1.00	0.15		0.77	0.23
Lane Grp Cap(c), veh/h	1234	1046	1093	0	416	0
V/C Ratio(X)	0.29	0.36	0.33	0.00	0.89	0.00
Avail Cap(c_a), veh/h	1234	1046	1093	0	683	0
HCM Platoon Ratio	1.00	1.00	1.00	1.00	1.00	1.00
Upstream Filter(l)	1.00	1.00	1.00	0.00	1.00	0.00
Uniform Delay (d), s/veh	6.4	6.8	6.4	0.0	33.1	0.0
Incr Delay (d2), s/veh	0.1	0.2	0.8	0.0	8.6	0.0
Initial Q Delay(d3),s/veh	0.0	0.0	0.0	0.0	0.0	0.0
%ile BackOfQ(50%),veh/ln	2.2	2.5	2.4	0.0	8.2	0.0
Unsig. Movement Delay, s/veh						
LnGrp Delay(d),s/veh	6.6	7.1	7.2	0.0	41.7	0.0
LnGrp LOS	A	A	A	A	D	A
Approach Vol, veh/h	736			357	371	
Approach Delay, s/veh	6.8			7.2	41.7	
Approach LOS	A			A	D	
Timer - Assigned Phs		2			6	8
Phs Duration (G+Y+Rc), s		63.9			63.9	26.1
Change Period (Y+Rc), s		4.5			4.5	4.5
Max Green Setting (Gmax), s		39.5			45.5	35.5
Max Q Clear Time (g_c+I1), s		9.2			11.6	20.6
Green Ext Time (p_c), s		2.3			3.5	1.0

Intersection Summary

HCM 6th Ctrl Delay	15.7
HCM 6th LOS	B

Notes

User approved volume balancing among the lanes for turning movement.

Intersection						
Int Delay, s/veh	0.3					
Movement	EBL	EBT	WBT	WBR	SBL	SBR
Lane Configurations		↕	↕		↕	
Traffic Vol, veh/h	11	693	455	4	8	9
Future Vol, veh/h	11	693	455	4	8	9
Conflicting Peds, #/hr	0	0	0	0	0	0
Sign Control	Free	Free	Free	Free	Stop	Stop
RT Channelized	-	None	-	None	-	None
Storage Length	-	-	-	-	0	-
Veh in Median Storage, #	-	0	0	-	0	-
Grade, %	-	0	0	-	0	-
Peak Hour Factor	99	99	99	99	99	99
Heavy Vehicles, %	2	2	2	2	2	2
Mvmt Flow	11	700	460	4	8	9

Major/Minor	Major1	Major2	Minor2		
Conflicting Flow All	464	0	-	0	1184 462
Stage 1	-	-	-	-	462 -
Stage 2	-	-	-	-	722 -
Critical Hdwy	4.12	-	-	-	6.42 6.22
Critical Hdwy Stg 1	-	-	-	-	5.42 -
Critical Hdwy Stg 2	-	-	-	-	5.42 -
Follow-up Hdwy	2.218	-	-	-	3.518 3.318
Pot Cap-1 Maneuver	1097	-	-	-	209 600
Stage 1	-	-	-	-	634 -
Stage 2	-	-	-	-	481 -
Platoon blocked, %		-	-	-	
Mov Cap-1 Maneuver	1097	-	-	-	206 600
Mov Cap-2 Maneuver	-	-	-	-	206 -
Stage 1	-	-	-	-	624 -
Stage 2	-	-	-	-	481 -

Approach	EB	WB	SB
HCM Control Delay, s	0.1	0	17
HCM LOS			C

Minor Lane/Major Mvmt	EBL	EBT	WBT	WBR	SBLn1
Capacity (veh/h)	1097	-	-	-	316
HCM Lane V/C Ratio	0.01	-	-	-	0.054
HCM Control Delay (s)	8.3	0	-	-	17
HCM Lane LOS	A	A	-	-	C
HCM 95th %tile Q(veh)	0	-	-	-	0.2

FUTURE "BUILD" INTERSECTION ANALYSIS

Timings
 1: Harmony Church Rd & SR 323 (Gillsville Hwy)



Lane Group	EBT	EBR	WBL	WBT	NBL
Lane Configurations	↑	↑		↑	↑
Traffic Volume (vph)	147	83	40	163	386
Future Volume (vph)	147	83	40	163	386
Lane Group Flow (vph)	171	97	0	237	541
Turn Type	NA	Perm	Perm	NA	Prot
Protected Phases	6			2	3
Permitted Phases		6	2		
Detector Phase	6	6	2	2	3
Switch Phase					
Minimum Initial (s)	5.0	5.0	5.0	5.0	5.0
Minimum Split (s)	22.5	22.5	22.5	22.5	22.5
Total Split (s)	42.0	42.0	42.0	42.0	48.0
Total Split (%)	46.7%	46.7%	46.7%	46.7%	53.3%
Yellow Time (s)	3.5	3.5	3.5	3.5	3.5
All-Red Time (s)	1.0	1.0	1.0	1.0	1.0
Lost Time Adjust (s)	0.0	0.0		0.0	0.0
Total Lost Time (s)	4.5	4.5		4.5	4.5
Lead/Lag					
Lead-Lag Optimize?					
Recall Mode	None	None	C-Min	C-Min	Min
v/c Ratio	0.17	0.11		0.26	0.82
Control Delay	13.5	5.4		14.4	34.7
Queue Delay	0.0	0.0		0.0	0.0
Total Delay	13.5	5.4		14.4	34.7
Queue Length 50th (ft)	51	6		74	273
Queue Length 95th (ft)	101	33		140	320
Internal Link Dist (ft)	1795			886	696
Turn Bay Length (ft)		25			
Base Capacity (vph)	981	870		902	852
Starvation Cap Reductn	0	0		0	0
Spillback Cap Reductn	0	0		0	0
Storage Cap Reductn	0	0		0	0
Reduced v/c Ratio	0.17	0.11		0.26	0.63

Intersection Summary

Cycle Length: 90
 Actuated Cycle Length: 90
 Offset: 0 (0%), Referenced to phase 2:WBTL, Start of Green
 Natural Cycle: 50
 Control Type: Actuated-Coordinated

Splits and Phases: 1: Harmony Church Rd & SR 323 (Gillsville Hwy)

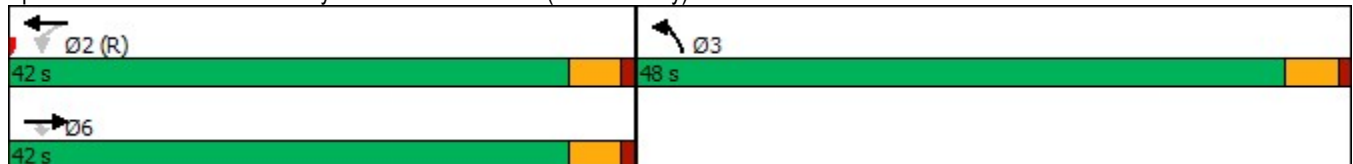

HCM 6th Signalized Intersection Summary
 1: Harmony Church Rd & SR 323 (Gillsville Hwy)

3a. Build AM
 03/24/2023



Movement	EBT	EBR	WBL	WBT	NBL	NBR
Lane Configurations	↑	↑		↑	↑	
Traffic Volume (veh/h)	147	83	40	163	386	79
Future Volume (veh/h)	147	83	40	163	386	79
Initial Q (Qb), veh	0	0	0	0	0	0
Ped-Bike Adj(A_pbT)		1.00	1.00		1.00	1.00
Parking Bus, Adj	1.00	1.00	1.00	1.00	1.00	1.00
Work Zone On Approach	No			No	No	
Adj Sat Flow, veh/h/ln	1870	1870	1870	1870	1870	1870
Adj Flow Rate, veh/h	171	97	47	190	449	92
Peak Hour Factor	0.86	0.86	0.86	0.86	0.86	0.86
Percent Heavy Veh, %	2	2	2	2	2	2
Cap, veh/h	1051	891	202	792	488	100
Arrive On Green	0.56	0.56	0.56	0.56	0.34	0.34
Sat Flow, veh/h	1870	1585	275	1408	1445	296
Grp Volume(v), veh/h	171	97	237	0	542	0
Grp Sat Flow(s),veh/h/ln	1870	1585	1683	0	1745	0
Q Serve(g_s), s	4.0	2.6	0.0	0.0	26.9	0.0
Cycle Q Clear(g_c), s	4.0	2.6	5.7	0.0	26.9	0.0
Prop In Lane		1.00	0.20		0.83	0.17
Lane Grp Cap(c), veh/h	1051	891	994	0	589	0
V/C Ratio(X)	0.16	0.11	0.24	0.00	0.92	0.00
Avail Cap(c_a), veh/h	1051	891	994	0	843	0
HCM Platoon Ratio	1.00	1.00	1.00	1.00	1.00	1.00
Upstream Filter(l)	1.00	1.00	1.00	0.00	1.00	0.00
Uniform Delay (d), s/veh	9.5	9.2	9.9	0.0	28.6	0.0
Incr Delay (d2), s/veh	0.1	0.1	0.6	0.0	11.6	0.0
Initial Q Delay(d3),s/veh	0.0	0.0	0.0	0.0	0.0	0.0
%ile BackOfQ(50%),veh/ln	1.4	0.8	2.2	0.0	11.9	0.0
Unsig. Movement Delay, s/veh						
LnGrp Delay(d),s/veh	9.6	9.2	10.4	0.0	40.2	0.0
LnGrp LOS	A	A	B	A	D	A
Approach Vol, veh/h	268			237	542	
Approach Delay, s/veh	9.4			10.4	40.2	
Approach LOS	A			B	D	
Timer - Assigned Phs		2			6	8
Phs Duration (G+Y+Rc), s		55.1			55.1	34.9
Change Period (Y+Rc), s		4.5			4.5	4.5
Max Green Setting (Gmax), s		37.5			37.5	43.5
Max Q Clear Time (g_c+I1), s		7.7			6.0	28.9
Green Ext Time (p_c), s		1.3			1.2	1.6

Intersection Summary

HCM 6th Ctrl Delay	25.6
HCM 6th LOS	C

Notes

User approved volume balancing among the lanes for turning movement.

Intersection						
Int Delay, s/veh	0.2					
Movement	EBL	EBT	WBT	WBR	SBL	SBR
Lane Configurations		↶	↷		↶	↷
Traffic Vol, veh/h	4	235	722	3	4	6
Future Vol, veh/h	4	235	722	3	4	6
Conflicting Peds, #/hr	0	0	0	0	0	0
Sign Control	Free	Free	Free	Free	Stop	Stop
RT Channelized	-	None	-	None	-	None
Storage Length	-	-	-	-	0	-
Veh in Median Storage, #	-	0	0	-	0	-
Grade, %	-	0	0	-	0	-
Peak Hour Factor	90	90	90	90	90	90
Heavy Vehicles, %	2	2	2	2	2	2
Mvmt Flow	4	261	802	3	4	7

Major/Minor	Major1	Major2	Minor2		
Conflicting Flow All	805	0	-	0	1073 804
Stage 1	-	-	-	-	804 -
Stage 2	-	-	-	-	269 -
Critical Hdwy	4.12	-	-	-	6.42 6.22
Critical Hdwy Stg 1	-	-	-	-	5.42 -
Critical Hdwy Stg 2	-	-	-	-	5.42 -
Follow-up Hdwy	2.218	-	-	-	3.518 3.318
Pot Cap-1 Maneuver	819	-	-	-	244 383
Stage 1	-	-	-	-	440 -
Stage 2	-	-	-	-	776 -
Platoon blocked, %		-	-	-	
Mov Cap-1 Maneuver	819	-	-	-	243 383
Mov Cap-2 Maneuver	-	-	-	-	243 -
Stage 1	-	-	-	-	437 -
Stage 2	-	-	-	-	776 -

Approach	EB	WB	SB
HCM Control Delay, s	0.2	0	17
HCM LOS			C

Minor Lane/Major Mvmt	EBL	EBT	WBT	WBR	SBLn1
Capacity (veh/h)	819	-	-	-	311
HCM Lane V/C Ratio	0.005	-	-	-	0.036
HCM Control Delay (s)	9.4	0	-	-	17
HCM Lane LOS	A	A	-	-	C
HCM 95th %tile Q(veh)	0	-	-	-	0.1

Intersection						
Int Delay, s/veh	0					
Movement	EBL	EBR	NBL	NBT	SBT	SBR
Lane Configurations	W			W	W	
Traffic Vol, veh/h	0	0	0	6	8	0
Future Vol, veh/h	0	0	0	6	8	0
Conflicting Peds, #/hr	0	0	0	0	0	0
Sign Control	Free	Free	Free	Free	Stop	Stop
RT Channelized	-	None	-	None	-	None
Storage Length	0	-	-	-	-	-
Veh in Median Storage, #	1	-	-	0	0	-
Grade, %	0	-	-	0	0	-
Peak Hour Factor	92	92	92	92	92	92
Heavy Vehicles, %	2	2	2	2	2	2
Mvmt Flow	0	0	0	7	9	0

Major/Minor	Major1	Minor2
Conflicting Flow All	0	0 7 0
Stage 1	-	- 0 -
Stage 2	-	- 7 -
Critical Hdwy	4.12	- 6.52 6.22
Critical Hdwy Stg 1	-	- - -
Critical Hdwy Stg 2	-	- 5.52 -
Follow-up Hdwy	2.218	- 4.018 3.318
Pot Cap-1 Maneuver	-	- 888 -
Stage 1	-	- - -
Stage 2	-	- 890 -
Platoon blocked, %		-
Mov Cap-1 Maneuver	-	- 0 -
Mov Cap-2 Maneuver	-	- 0 -
Stage 1	-	- 0 -
Stage 2	-	- 0 -

Approach	NB	SB
HCM Control Delay, s	0	
HCM LOS		-

Minor Lane/Major Mvmt	NBL	NBT	SBLn1
Capacity (veh/h)	-	-	-
HCM Lane V/C Ratio	-	-	-
HCM Control Delay (s)	0	-	-
HCM Lane LOS	A	-	-
HCM 95th %tile Q(veh)	-	-	-

Timings
 1: Harmony Church Rd & SR 323 (Gillsville Hwy)



Lane Group	EBT	EBR	WBL	WBT	NBL
Lane Configurations	↑	↗		↖	↘
Traffic Volume (vph)	347	365	49	298	276
Future Volume (vph)	347	365	49	298	276
Lane Group Flow (vph)	365	384	0	366	376
Turn Type	NA	Perm	Perm	NA	Prot
Protected Phases	6			2	3
Permitted Phases		6	2		
Detector Phase	6	6	2	2	3
Switch Phase					
Minimum Initial (s)	5.0	5.0	5.0	5.0	5.0
Minimum Split (s)	22.5	22.5	22.5	22.5	22.5
Total Split (s)	50.0	50.0	50.0	50.0	40.0
Total Split (%)	55.6%	55.6%	55.6%	55.6%	44.4%
Yellow Time (s)	3.5	3.5	3.5	3.5	3.5
All-Red Time (s)	1.0	1.0	1.0	1.0	1.0
Lost Time Adjust (s)	0.0	0.0		0.0	0.0
Total Lost Time (s)	4.5	4.5		4.5	4.5
Lead/Lag					
Lead-Lag Optimize?					
Recall Mode	None	None	C-Min	C-Min	Min
v/c Ratio	0.31	0.36		0.34	0.78
Control Delay	9.6	6.2		10.1	40.0
Queue Delay	0.0	0.0		0.0	0.0
Total Delay	9.6	6.2		10.1	40.0
Queue Length 50th (ft)	90	50		92	196
Queue Length 95th (ft)	178	127		185	266
Internal Link Dist (ft)	1795			886	696
Turn Bay Length (ft)		25			
Base Capacity (vph)	1175	1060		1069	697
Starvation Cap Reductn	0	0		0	0
Spillback Cap Reductn	0	0		0	0
Storage Cap Reductn	0	0		0	0
Reduced v/c Ratio	0.31	0.36		0.34	0.54

Intersection Summary

Cycle Length: 90
 Actuated Cycle Length: 90
 Offset: 0 (0%), Referenced to phase 2:WBTL, Start of Green
 Natural Cycle: 45
 Control Type: Actuated-Coordinated

Splits and Phases: 1: Harmony Church Rd & SR 323 (Gillsville Hwy)

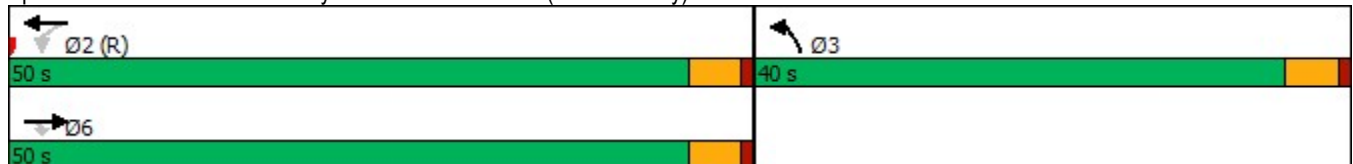

HCM 6th Signalized Intersection Summary
 1: Harmony Church Rd & SR 323 (Gillsville Hwy)

3b. Build PM
 03/24/2023



Movement	EBT	EBR	WBL	WBT	NBL	NBR
Lane Configurations	↑	↗		↖	↖	↗
Traffic Volume (veh/h)	347	365	49	298	276	81
Future Volume (veh/h)	347	365	49	298	276	81
Initial Q (Qb), veh	0	0	0	0	0	0
Ped-Bike Adj(A_pbT)		1.00	1.00		1.00	1.00
Parking Bus, Adj	1.00	1.00	1.00	1.00	1.00	1.00
Work Zone On Approach	No			No	No	
Adj Sat Flow, veh/h/ln	1870	1870	1870	1870	1870	1870
Adj Flow Rate, veh/h	365	384	52	314	291	85
Peak Hour Factor	0.95	0.95	0.95	0.95	0.95	0.95
Percent Heavy Veh, %	2	2	2	2	2	2
Cap, veh/h	1228	1041	159	931	326	95
Arrive On Green	0.66	0.66	0.66	0.66	0.24	0.24
Sat Flow, veh/h	1870	1585	172	1418	1338	391
Grp Volume(v), veh/h	365	384	366	0	377	0
Grp Sat Flow(s),veh/h/ln	1870	1585	1591	0	1733	0
Q Serve(g_s), s	7.5	9.9	0.0	0.0	18.9	0.0
Cycle Q Clear(g_c), s	7.5	9.9	7.5	0.0	18.9	0.0
Prop In Lane		1.00	0.14		0.77	0.23
Lane Grp Cap(c), veh/h	1228	1041	1090	0	422	0
V/C Ratio(X)	0.30	0.37	0.34	0.00	0.89	0.00
Avail Cap(c_a), veh/h	1228	1041	1090	0	684	0
HCM Platoon Ratio	1.00	1.00	1.00	1.00	1.00	1.00
Upstream Filter(l)	1.00	1.00	1.00	0.00	1.00	0.00
Uniform Delay (d), s/veh	6.6	7.0	6.6	0.0	32.9	0.0
Incr Delay (d2), s/veh	0.1	0.2	0.8	0.0	8.9	0.0
Initial Q Delay(d3),s/veh	0.0	0.0	0.0	0.0	0.0	0.0
%ile BackOfQ(50%),veh/ln	2.3	2.6	2.5	0.0	8.3	0.0
Unsig. Movement Delay, s/veh						
LnGrp Delay(d),s/veh	6.7	7.2	7.4	0.0	41.9	0.0
LnGrp LOS	A	A	A	A	D	A
Approach Vol, veh/h	749			366	377	
Approach Delay, s/veh	7.0			7.4	41.9	
Approach LOS	A			A	D	
Timer - Assigned Phs		2			6	8
Phs Duration (G+Y+Rc), s		63.6			63.6	26.4
Change Period (Y+Rc), s		4.5			4.5	4.5
Max Green Setting (Gmax), s		45.5			45.5	35.5
Max Q Clear Time (g_c+I1), s		9.5			11.9	20.9
Green Ext Time (p_c), s		2.5			3.6	1.0

Intersection Summary

HCM 6th Ctrl Delay	15.9
HCM 6th LOS	B

Notes

User approved volume balancing among the lanes for turning movement.

Intersection						
Int Delay, s/veh	1.3					
Movement	EBL	EBT	WBT	WBR	SBL	SBR
Lane Configurations		↕	↕		↕	
Traffic Vol, veh/h	49	693	455	17	21	47
Future Vol, veh/h	49	693	455	17	21	47
Conflicting Peds, #/hr	0	0	0	0	0	0
Sign Control	Free	Free	Free	Free	Stop	Stop
RT Channelized	-	None	-	None	-	None
Storage Length	-	-	-	-	0	-
Veh in Median Storage, #	-	0	0	-	0	-
Grade, %	-	0	0	-	0	-
Peak Hour Factor	99	99	99	99	99	99
Heavy Vehicles, %	2	2	2	2	2	2
Mvmt Flow	49	700	460	17	21	47

Major/Minor	Major1	Major2	Minor2		
Conflicting Flow All	477	0	-	0	1267 469
Stage 1	-	-	-	-	469 -
Stage 2	-	-	-	-	798 -
Critical Hdwy	4.12	-	-	-	6.42 6.22
Critical Hdwy Stg 1	-	-	-	-	5.42 -
Critical Hdwy Stg 2	-	-	-	-	5.42 -
Follow-up Hdwy	2.218	-	-	-	3.518 3.318
Pot Cap-1 Maneuver	1085	-	-	-	186 594
Stage 1	-	-	-	-	630 -
Stage 2	-	-	-	-	443 -
Platoon blocked, %		-	-	-	
Mov Cap-1 Maneuver	1085	-	-	-	172 594
Mov Cap-2 Maneuver	-	-	-	-	172 -
Stage 1	-	-	-	-	583 -
Stage 2	-	-	-	-	443 -

Approach	EB	WB	SB
HCM Control Delay, s	0.6	0	18.3
HCM LOS			C

Minor Lane/Major Mvmt	EBL	EBT	WBT	WBR	SBLn1
Capacity (veh/h)	1085	-	-	-	338
HCM Lane V/C Ratio	0.046	-	-	-	0.203
HCM Control Delay (s)	8.5	0	-	-	18.3
HCM Lane LOS	A	A	-	-	C
HCM 95th %tile Q(veh)	0.1	-	-	-	0.7

Intersection						
Int Delay, s/veh	6.1					
Movement	EBL	EBR	NBL	NBT	SBT	SBR
Lane Configurations	T			T		
Traffic Vol, veh/h	0	50	50	16	15	0
Future Vol, veh/h	0	50	50	16	15	0
Conflicting Peds, #/hr	0	0	0	0	0	0
Sign Control	Stop	Stop	Free	Free	Free	Free
RT Channelized	-	None	-	None	-	None
Storage Length	0	-	-	-	-	-
Veh in Median Storage, #	0	-	-	0	0	-
Grade, %	0	-	-	0	0	-
Peak Hour Factor	92	92	92	92	92	92
Heavy Vehicles, %	2	2	2	2	2	2
Mvmt Flow	0	54	54	17	16	0

Major/Minor	Minor2	Major1		Major2	
Conflicting Flow All	141	16	16	0	0
Stage 1	16	-	-	-	-
Stage 2	125	-	-	-	-
Critical Hdwy	6.42	6.22	4.12	-	-
Critical Hdwy Stg 1	5.42	-	-	-	-
Critical Hdwy Stg 2	5.42	-	-	-	-
Follow-up Hdwy	3.518	3.318	2.218	-	-
Pot Cap-1 Maneuver	852	1063	1602	-	-
Stage 1	1007	-	-	-	-
Stage 2	901	-	-	-	-
Platoon blocked, %				-	-
Mov Cap-1 Maneuver	823	1063	1602	-	-
Mov Cap-2 Maneuver	823	-	-	-	-
Stage 1	973	-	-	-	-
Stage 2	901	-	-	-	-

Approach	EB	NB	SB
HCM Control Delay, s	8.6	5.6	0
HCM LOS	A		

Minor Lane/Major Mvmt	NBL	NBT	EBLn1	SBT	SBR
Capacity (veh/h)	1602	-	1063	-	-
HCM Lane V/C Ratio	0.034	-	0.051	-	-
HCM Control Delay (s)	7.3	0	8.6	-	-
HCM Lane LOS	A	A	A	-	-
HCM 95th %tile Q(veh)	0.1	-	0.2	-	-

TRAFFIC VOLUME WORKSHEETS

23-031 Joe Parker Special Events Facility at 3210 Joe Parker Road - Hall County, GA
Traffic Volumes

A&R Engineering
March 2023

1. SR 323 @ Harmony Church Rd

A.M. Peak Hour

Condition	Harmony Church Road Northbound				- Southbound				SR 323 (Gillsville Highway) Eastbound				SR 323 (Gillsville Highway) Westbound			
	L	T	R	Tot	L	T	R	Tot	L	T	R	Tot	L	T	R	Tot
Existing 2023 Traffic Counts:	378	0	77	455	0	0	0	0	0	144	81	225	39	160	0	199
Growth Factor (%):	1	1	1		1	1	1		1	1	1		1	1	1	
No-Build 2025 Volumes:	386	0	79	465	0	0	0	0	0	147	83	230	40	163	0	203
Total New Trips:	0	0	0	0	0	0	0	0	0	0	0	0	0	0	0	0
Future 2025 Traffic Volumes:	386	0	79	465	0	0	0	0	0	147	83	230	40	163	0	203

P.M. Peak Hour

Condition	Harmony Church Road Northbound				- Southbound				SR 323 (Gillsville Highway) Eastbound				SR 323 (Gillsville Highway) Westbound			
	L	T	R	Tot	L	T	R	Tot	L	T	R	Tot	L	T	R	Tot
Existing 2023 Traffic Counts:	266	0	79	345	0	0	0	0	0	332	353	685	48	284	0	332
Growth Factor (%):	1	1	1		1	1	1		1	1	1		1	1	1	
No-Build 2025 Volumes:	271	0	81	352	0	0	0	0	0	339	360	699	49	290	0	339
Total New Trips:	5	0	0	5	0	0	0	0	0	8	5	13	0	8	0	8
Future 2025 Traffic Volumes:	276	0	81	357	0	0	0	0	0	347	365	712	49	298	0	347

23-031 Joe Parker Special Events Facility at 3210 Joe Parker Road - Hall County, GA
Traffic Volumes

A&R Engineering
March 2023

2. SR 323 @ Joe Parker Rd

A.M. Peak Hour

Condition	-				Joe Parker Road				SR 323 (Gillsville Highway)				SR 323 (Gillsville Highway)			
	Northbound				Southbound				Eastbound				Westbound			
	L	T	R	Tot	L	T	R	Tot	L	T	R	Tot	L	T	R	Tot
Existing 2023 Traffic Counts:	0	0	0	0	4	0	6	10	4	230	0	234	0	708	3	711
Growth Factor (%):	1	1	1		1	1	1		1	1	1		1	1	1	
No-Build 2025 Volumes:	0	0	0	0	4	0	6	10	4	235	0	239	0	722	3	725
Total New Trips:	0	0	0	0	0	0	0	0	0	0	0	0	0	0	0	0
Future 2025 Traffic Volumes:	0	0	0	0	4	0	6	10	4	235	0	239	0	722	3	725

P.M. Peak Hour

Condition	-				Joe Parker Road				SR 323 (Gillsville Highway)				SR 323 (Gillsville Highway)			
	Northbound				Southbound				Eastbound				Westbound			
	L	T	R	Tot	L	T	R	Tot	L	T	R	Tot	L	T	R	Tot
Existing 2023 Traffic Counts:	0	0	0	0	8	0	9	17	11	679	0	690	0	446	4	450
Growth Factor (%):	1	1	1		1	1	1		1	1	1		1	1	1	
No-Build 2025 Volumes:	0	0	0	0	8	0	9	17	11	693	0	704	0	455	4	459
Total New Trips:	0	0	0	0	13	0	38	51	38	0	0	38	0	0	13	13
Future 2025 Traffic Volumes:	0	0	0	0	21	0	47	68	49	693	0	742	0	455	17	472

23-031 Joe Parker Special Events Facility at 3210 Joe Parker Road - Hall County, GA
Traffic Volumes

A&R Engineering
March 2023

3. Joe Parker Rd @ Site Drwy

A.M. Peak Hour

Condition	Joe Parker Road Northbound				Joe Parker Road Southbound				Site Driveway Eastbound				- Westbound			
	L	T	R	Tot	L	T	R	Tot	L	T	R	Tot	L	T	R	Tot
Existing 2023 Traffic Counts:	0	6	0	6	0	8	0	8	0	0	0	0	0	0	0	0
Growth Factor (%):	1	1	1		1	1	1		1	1	1		1	1	1	
No-Build 2025 Volumes:	0	6	0	6	0	8	0	8	0	0	0	0	0	0	0	0
Total New Trips:	0	0	0	0	0	0	0	0	0	0	0	0	0	0	0	0
Future 2025 Traffic Volumes:	0	6	0	6	0	8	0	8	0	0	0	0	0	0	0	0

P.M. Peak Hour

Condition	Joe Parker Road Northbound				Joe Parker Road Southbound				Site Driveway Eastbound				- Westbound			
	L	T	R	Tot	L	T	R	Tot	L	T	R	Tot	L	T	R	Tot
Existing 2023 Traffic Counts:	0	16	0	16	0	15	0	15	0	0	0	0	0	0	0	0
Growth Factor (%):	1	1	1		1	1	1		1	1	1		1	1	1	
No-Build 2025 Volumes:	0	16	0	16	0	15	0	15	0	0	0	0	0	0	0	0
Total New Trips:	50	0	0	50	0	0	0	0	0	0	50	50	0	0	0	0
Future 2025 Traffic Volumes:	50	16	0	66	0	15	0	15	0	0	50	50	0	0	0	0