

TRAFFIC IMPACT STUDY

For Proposed Residence at Cagle Mill Development
Hall County, GA



Report Prepared For:
Audubon Communities

Report Prepared By:
Pond & Company
Zachary G. Puckett, P.E.
3500 Parkway Lane, Suite 500
Peachtree Corners, GA 30092



AUDUBON

Telephone Number: (678)336-7740
E-mail Address: *puckettz@pondco.com*
Date Report Prepared: February 2024

POND

1. INTRODUCTION

The purpose of this study is to evaluate the traffic-related impacts associated with the proposed residential development to be located between Cagle Mill Road and US 23/SR 365/Cornelia Highway in unincorporated Hall County, Georgia. This study presents and documents Pond’s data collection, summarizes the analysis of the current and projected future traffic operations, and evaluates the impacts of the traffic generated by the development. This report will compare conditions with and without the proposed development to address the potential impact of site-generated traffic on the adjacent roadway network. The report will also identify improvements needed to mitigate any identified deficiencies. This study will analyze opening and design years of 2023 and 2028, respectively.

The proposed development is expected to consist of 348 lots, including 297 single-family residential units and 51 townhomes. The study utilizes standard procedures based on the Institute of Transportation Engineers (ITE) to determine the additional amount of traffic that will be generated by the proposed development. A summary of the proposed land-uses and intensities can be found below in **Table 1-1**.

Table 1-1: Proposed Land Uses and Intensities

| Land Use | ITE Land Use Code | Intensity |
|--------------------------------|--------------------------------------|-----------|
| Single Family Type “A (35x60)” | 210 – Single-Family Detached Housing | 297 units |
| Single Family Type “B” | | |
| Townhome (35x40) | 220 – Multifamily Housing (Low-Rise) | 51 units |
| Cluster home | | |
| Clubhouse | - | 4,130 SF |

This report summarizes the analyses of the following (5) scenarios:

1. COVID-19 Adjusted 2022 Existing Traffic Conditions
2. Projected 2023 No-Build Traffic Conditions*
3. Projected 2023 Build Traffic Conditions
4. Projected 2028 No-Build Traffic Conditions*
5. Projected 2028 Build Traffic Conditions

*excludes trips associated with proposed development

2. PROJECT BACKGROUND AND EXISTING CONDITIONS

2.1 Project Location

As is illustrated in **Figure 2-1**, the project is located between Cagle Mill Road and US 23/SR 365/Cornelia Highway in Hall County, Georgia. The proposed residential development is to be located on property consisting of multiple parcels with an area of approximately 125 acres. The site is by SR 365 to the west and Cagle Mill Road to the east. The site plan is presented in **Figure 2-2**.

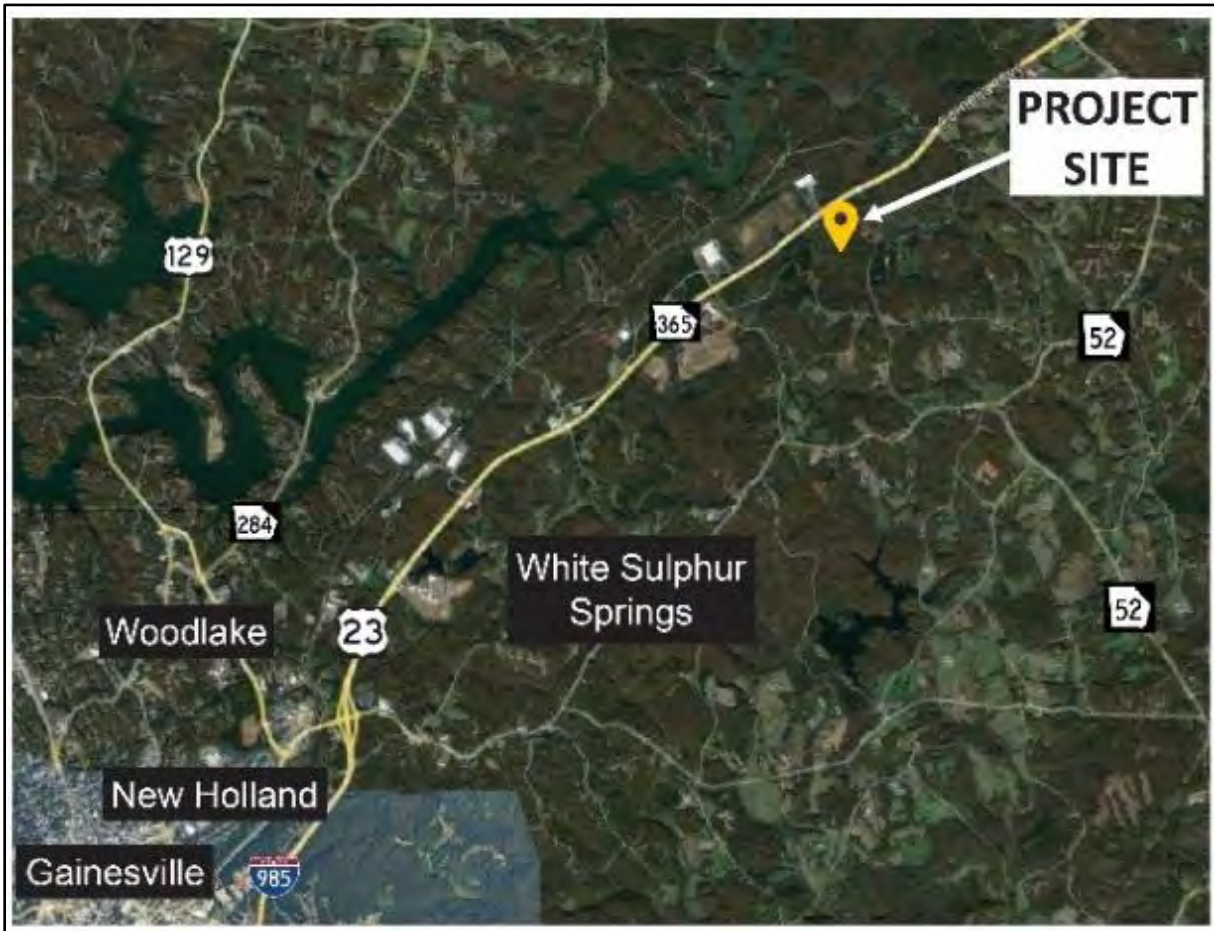

Figure 2-1. Project Location



Figure 2-2. Site Plan

2.2 Site Access

The development proposes three access points at the following locations.

- Proposed limited access driveway on Cornelia Highway/SR 365.
 - The development will convert the existing full access driveway to a Restricted Crossing U-turn (RCUT) configuration upon build-out of the development.
- Proposed full access driveway on Cagle Mill Road.
- Proposed full access driveway on Whitehall Road.

2.3 Bicycle and Pedestrian Facilities

Neither pedestrian facilities nor bicycle facilities are provided along US 23/SR 365/Cornelia Highway or Cagle Mill Road in the vicinity of the study area.

2.4 Existing Transportation Facilities

This section provides a description of the existing roadways within the study area.

- **US 23/SR 365/Cornelia Highway**
US 23/SR 365/Cornelia Highway is a two-way, four-lane roadway providing north-south mobility between Gwinnett County and Hall County. GDOT classifies this roadway as a Principal Arterial. The road has a posted speed limit of 65 mph. Collected traffic count data determined the Average Daily Traffic (ADT) along this roadway to be 38,014 vehicles per day.
- **Cagle Mill Road**
Cagle Mill Road is a north-south roadway within the study area. It originates at Whitehall Road and traverses north through the study area and terminates at the intersection of Cagle Road and Julian Baugh Road. Adjacent to the proposed site, Cagle Mill Road is a two-lane, undivided roadway with a posted speed limit of 30 mph. GDOT classifies Old Alabama Road as a Local Road. Collected traffic count data determined the Average Daily Traffic (ADT) along this roadway to be 134 vehicles per day.
- **Cagle Road**
Cagle Road is a two-lane, east-west roadway within the study area. GDOT classifies this roadway as a Local Road. The road has a posted speed limit of 35 mph.
- **Whitehall Road**
Whitehall Road is a two-lane, east-west roadway within the study area. GDOT classifies this roadway as a Local Road. The road has a posted speed limit of 40 mph.
- **Noah Martin Road**
Noah Martin Road is a two-lane, north-south roadway within the study area. GDOT classifies this roadway as a Local Road. The road has a posted speed limit of 40 mph.
- **Old Cornelia Highway**
Old Cornelia Highway is a two-lane, east-west roadway within the study area. GDOT classifies this roadway as a Major Collector. The road has a posted speed limit of 55 mph. Collected traffic count data determined the Average Daily Traffic (ADT) along this roadway to be 4,506 vehicles per day.

2.5 Study Network Determination

The study area consists of the following existing intersections:

1. US 23/SR 365/Cornelia Highway at Americold Logistics/Proposed Driveway (Minor Street Stop Control, Full Access)
2. Cagle Road at Cagle Mill Road/Julian Baugh Road (Minor Street Stop Control, Full Access)
3. Cagle Mill Road at Julian Baugh Road (Minor Street Stop Control, Full Access)
4. Cagle Mill Road/Noah Martin Road at Whitehall Road (Minor Street Stop Control, Full Access)
5. Old Cornelia Highway at Noah Martin Road (Minor Street Stop Control, Full Access)
6. US 23/SR 365/Cornelia Highway at Cagle Road (Minor Street Stop Control, Full Access)

2.6 Traffic Volumes

Traffic counts were performed on Wednesday, March 30, 2022. These counts were collected at the study area intersections when local schools were in session and outside of holiday periods. The traffic counts included (6) 6-hr turning movement count (TMC) including bicycle, pedestrian, and heavy vehicles (7:00-10:00AM, 10:00AM-2:00PM, 2:00-7:00PM) and (3) 24-hr Average Daily Traffic (ADT) counts with vehicle speeds and classification counts. 12-hr TMCs will be used to evaluate signal warrant analyses included in this study. The AM and PM peak hours for each intersection are shown in **Figure 2-3** below. These peak hours were determined by calculating the highest four consecutive 15-minute interval volumes at each intersection. Traffic count data is included in **Appendix C**.

2.7 Available Non-GDOT Historical Traffic Counts

No available historical traffic counts that were performed within the past three years were identified. Because every roadway segment and significant intersection in the project area will be counted, the proposed count locations are sufficient so that non-GDOT historical counts may be included in the COVID-19 adjustment methodology if any are identified in the future.

2.8 Available GDOT Historical Traffic Count Data

In order to determine 2022 volumes based on these counts, a compound annual growth rate of 3.25% was calculated based on GDOT historical traffic counts using an exponential regression model of best fit. This growth rate was then applied to the most recent year of GDOT historical counts in the area to estimate the 2022 AADT without the effects of COVID-19. Available GDOT Historical Count locations near the project area that will be used in the adjustment process are presented in **Figure 2-3**.

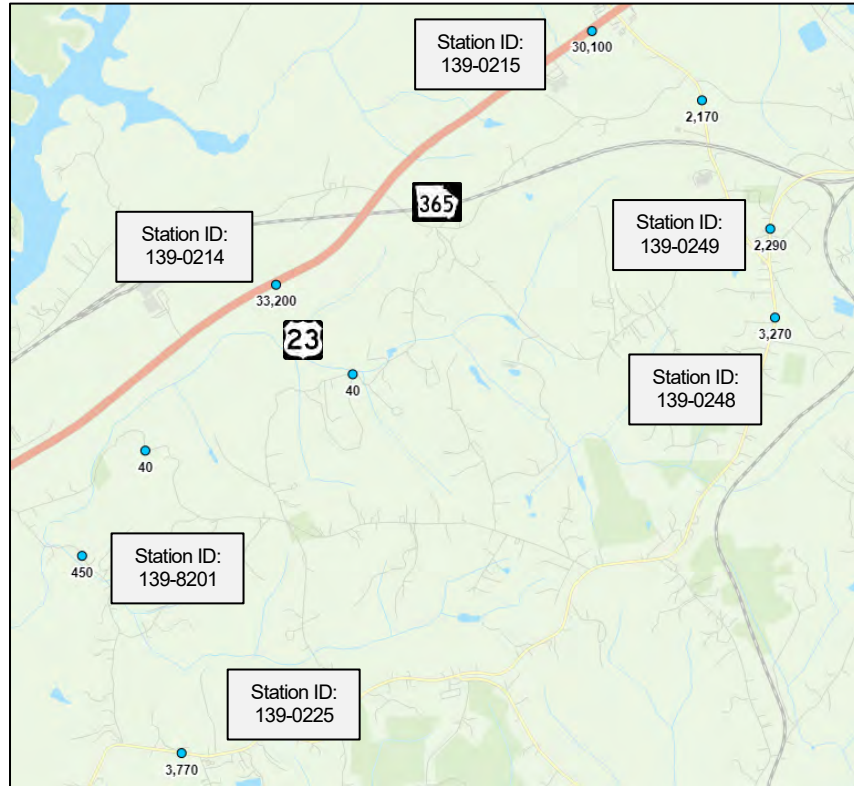

Figure 2-3. Location of GDOT Historical Traffic Count Stations in the Project Area

3. TRAFFIC ANALYSES METHODOLOGY AND ASSUMPTIONS

3.1 COVID-19 Factor Development

Due to altered traffic patterns resulting from the COVID-19 pandemic, collected traffic counts will need to be adjusted in order to reflect typical conditions. In order to account for the effects of the pandemic, a factor was developed and applied to the analyzed traffic volumes. The COVID-19 adjustment factor used in this study was developed by comparing historical traffic count data from GDOT’s TADA database with the ADT count data collected for this study at a shared location. The locations used are US 23/SR 365/Cornelia Highway south of Cagle Road, Cagle Mill Road south of Cagle Road, and Old Cornelia Highway east of Greenway Road. These locations are shown in **Figure 3-1**. The most recent pre-pandemic historical data available at these locations are from 2018 and 2019. The 2018 and 2019 count volumes were adjusted using a growth rate of 3.25%, calculated from GDOT historical data, to estimate a theoretical 2022 volume without the effects of COVID-19. The percentage difference between the theoretical 2022 daily volume and the collected 2022 daily volume, calculated to be 5%, was determined to be the COVID-19 adjustment factor and applied to all respective traffic volumes. The calculation of the COVID-19 adjustment factor is summarized in **Table 3-1**. Additional information regarding GDOT historical growth is included in the “Traffic Forecasting” section of this report. Existing COVID-19 adjusted volumes are included in the **Appendix**.

Table 3-1: Calculation of COVID-19 Factors

| TC Station | Location | Year of Most Recent GDOT Count | GDOT Historical ADT | Growth Rate | Theoretical 2022 ADT | Collected 2022 ADT | COVID-19 Factor |
|-------------------------|--|--------------------------------|---------------------|-------------|----------------------|--------------------|-----------------|
| 139-0214 | US 23/SR 365/Cornelia Hwy S/O Cagle Rd | 2018 | 35,216 | 3.25% | 40,022 | 38,014 | 1.05 |
| 139-8204 | Cagle Mill Rd S/O Cagle Rd | 2019 | 38 | 3.25% | 42 | 134 | 0.31 |
| 139-0225 | Old Cornelia Hwy S/O Country Lane | 2018 | 4,260 | 3.25% | 4,841 | 4,506 | 1.07 |
| Weighted Average | | | | | | | 1.05 |



Figure 3-1. GDOT Count Locations to be Used in COVID-19 Factor Development

3.2 Traffic Forecasting

GDOT provides historical count data which is used in analyzing historical volume trends and can be an indication of future growth. As presented in the COVID-19 Adjustment Methodology section of this memo, a compound annual growth rate was calculated using GDOT historical AADT data over the past 10 years at locations within the study area. This compound annual growth rate was calculated using an exponential regression model of best fit. 2020 data was excluded from this analysis due to the effects of the COVID-19 pandemic. This rate was calculated to be 3.25% and is included in **Table 3-2** below.

Table 3-2: GDOT Historical Traffic Count Data, CAGR Calculation, and Estimated 2022 Volumes

| TC | Location | AADT | | | | | | | | | | CAGR | |
|----------|---|-------|-------|-------|-------|-------|-------|------|-------|------|--------------------------|--------------|-------|
| | | 2011 | 2012 | 2013 | 2014 | 2015 | 2016 | 2017 | 2018 | 2019 | 2020* | | |
| 139-0214 | US 23/SR 365/Cornelia Hwy N/O Americold Logistics | | 26636 | | 28406 | | 31740 | | 35500 | | | | 5.0% |
| 139-0225 | Old Cornelia Hwy S/O County Lane | | | | 3850 | | | | 3930 | | | | 0.5% |
| 139-8201 | Simpson Rd S/O Whitehall Rd | | | | | | 400 | | | | 470 | | 5.5% |
| 139-0215 | US 23/SR 365/Cornelia Hwy S/O SR 52/Lula Rd | 27200 | | 27300 | | 30000 | | | | | 31700 | | 2.1% |
| 139-0249 | SR 52/Lula Rd E/O US 23/SR 365/Cornelia Hwy | | 2200 | | 2430 | | 2700 | | 2380 | | | | 1.7% |
| 139-0248 | SR 52/Old Cornelia Hwy S/O SR 52/Lula Rd | 3630 | | 3210 | | 3230 | | | | | 3450 | | -0.3% |
| | | | | | | | | | | | Weighted Average: | 3.25% | |

For the purposes of this study, the proposed development was assumed to be completed and generating traffic by 2023. Therefore, an opening year of 2023 and design year of 2028 were used to evaluate future traffic conditions at all study intersections. Based on the GDOT historical counts, a 3.25% growth rate was applied to the 2022 existing volumes to estimate future No-Build traffic volumes. The 2023 and 2028 No-Build traffic volumes are included in the **Appendix**.

4. TRIP GENERATION

As stated earlier, the proposed development will consist of 348 residential units. These include 297 single-family residential units and 51 townhomes. Anticipated trip generation for the developments was calculated using rates and equations contained in the Institute of Transportation Engineers’ (ITE) Trip Generation Manual, 11th Edition. The land use types that best represent the developments are Single-Family Detached Housing (ITE Code 210), and Low-Rise Multifamily Housing (ITE Code 220). The density and anticipated trip generation for the proposed development are displayed below in **Table 4-1**.

Table 4-1: Trip Generation

| ITE Code | Land Use | Units | Generated Trips | | |
|----------|--------------------------------|-------|-----------------|-----|-------|
| | | | AM | PM | Daily |
| 210 | Single-Family Detached Housing | 297 | 201 | 276 | 2747 |
| 220 | Multifamily Housing (Low-Rise) | 51 | 39 | 42 | 402 |

5. TRIP DISTRIBUTION AND ASSIGNMENT

Trip distribution was developed based on existing traffic count information and existing traffic patterns. **Table 5-1** shows the trip distribution of the trips generated by the proposed development through US 23/SR 365/Cornelia Highway and Cagle Mill Road. As described earlier, all analysis was prepared for 2028 conditions.

Table 5-1: Directional Distribution

| ITE Code | Trip Generation | | | | | | | | |
|----------|-----------------|-------|------|--------------------------|-------|------|--------------------------|-------|------|
| | Daily Traffic | | | AM Peak Hour of Adjacent | | | PM Peak Hour of Adjacent | | |
| | Total | Enter | Exit | Total | Enter | Exit | Total | Enter | Exit |
| 210 | 2747 | 1373 | 1374 | 201 | 52 | 149 | 276 | 174 | 102 |
| 220 | 402 | 201 | 201 | 39 | 9 | 30 | 42 | 26 | 16 |

Once directional trip distributions were determined, project trips (trips generated by the proposed development) were then assigned to the study area intersections based on these trip distributions. These project trips were first assigned to the study intersections at the access points prior to being carried through the study network. The trips were assigned to these three intersections according to the trip distributions for each land use and existing traffic volume counts. Similarly, trips were distributed at intersections downstream of the access points based on existing turning movement counts. **Table 5-2** shows the trip distribution of the trips from the development through the intersection of US 23/SR365/Cornelia Highway at Americold Logistics/development driveway/median break, while **Table 5-3** shows the trip distribution of the trips from the development through the intersection of Cagle Mill Road at the second development driveway, and Table 5-4 presents the distribution of development trips at the Whitehall Road driveway. Full trip distribution tables are included in the **Appendix**.

Table 5-2: Trip Distribution Along US 23/SR 365/Cornelia Highway

| Scenario | Trip Distribution Along US 23/SR 365/Cornelia Hwy | | | | |
|----------|---|--------------|----------------|--------------|----------------|
| | Total | To the North | From the North | To the South | From the South |
| AM | 135 | 35 | 12 | 66 | 22 |
| PM | 173 | 24 | 41 | 39 | 68 |

Table 5-3: Trip Distribution Along Cagle Mill Road

| Scenario | Trip Distribution Along Cagle Mill Rd | | | | |
|----------|---------------------------------------|--------------|----------------|--------------|----------------|
| | Total | To the North | From the North | To the South | From the South |
| AM | 16 | 4 | 1 | 8 | 3 |
| PM | 21 | 3 | 5 | 5 | 8 |

Table 5-3: Trip Distribution Along Cagle Mill Road

| Scenario | Trip Distribution Along Whitehall Rd | | | | |
|----------|--------------------------------------|-------------|---------------|-------------|---------------|
| | Total | To the East | From the East | To the West | From the West |
| AM | 2 | 1 | 1 | 0 | 0 |
| PM | 3 | 1 | 2 | 0 | 0 |

6. SIGNAL WARRANT ANALYSIS

The consideration of a traffic signal as an intersection control alternative at this currently unsignalized intersection required an analysis of turning movement volumes over the course of a 12-hour period to determine if any of the MUTCD signal warrants were met.

Note the side-street right-turn volumes were not included. Additionally, per GDOT policy, 100% volume levels were utilized in the analysis (no reductions were utilized). The warrant analysis was performed using the 12 HR TMC data collected for this study. COVID-19 adjusted volumes, in addition to volumes generated by the development, were analyzed for signal warrants.

6.1 Warrant 1, Eight-Hour Vehicular Volumes

Warrant 1 provides three separate conditions that can be met which indicate that the intersection being studied is suitable for a traffic signal. Condition A, the Minimum Vehicular Volume, is intended for locations where a large volume of intersecting traffic is the principal reason to consider a traffic signal. Condition B, the Interruption of Continuous Traffic, is intended for locations where Condition A is not satisfied, and where the traffic volume on the major street is so heavy that the traffic on the minor intersecting street suffers excessive delay or conflict in entering or crossing the major street. If neither condition is met for a full eight hours of the day, then the volume thresholds for each condition can be reduced by 20% and the intersection can be reevaluated with these reduced volumes. **Figure 6-1** is an illustration from the MUTCD of the volume thresholds used with each Condition.

| Condition A—Minimum Vehicular Volume | | | | | | | | | |
|---|--------------|--|------------------|------------------|------------------|---|------------------|------------------|------------------|
| Number of lanes for moving traffic on each approach | | Vehicles per hour on major street (total of both approaches) | | | | Vehicles per hour on higher-volume minor-street approach (one direction only) | | | |
| Major Street | Minor Street | 100% ^a | 80% ^b | 70% ^c | 56% ^d | 100% ^a | 80% ^b | 70% ^c | 56% ^d |
| 1 | 1 | 500 | 400 | 350 | 280 | 150 | 120 | 105 | 84 |
| 2 or more | 1 | 600 | 480 | 420 | 336 | 150 | 120 | 105 | 84 |
| 2 or more | 2 or more | 600 | 480 | 420 | 336 | 200 | 160 | 140 | 112 |
| 1 | 2 or more | 500 | 400 | 350 | 280 | 200 | 160 | 140 | 112 |

| Condition B—Interruption of Continuous Traffic | | | | | | | | | |
|---|--------------|--|------------------|------------------|------------------|---|------------------|------------------|------------------|
| Number of lanes for moving traffic on each approach | | Vehicles per hour on major street (total of both approaches) | | | | Vehicles per hour on higher-volume minor-street approach (one direction only) | | | |
| Major Street | Minor Street | 100% ^a | 80% ^b | 70% ^c | 56% ^d | 100% ^a | 80% ^b | 70% ^c | 56% ^d |
| 1 | 1 | 750 | 600 | 525 | 420 | 75 | 60 | 53 | 42 |
| 2 or more | 1 | 900 | 720 | 630 | 504 | 75 | 60 | 53 | 42 |
| 2 or more | 2 or more | 900 | 720 | 630 | 504 | 100 | 80 | 70 | 56 |
| 1 | 2 or more | 750 | 600 | 525 | 420 | 100 | 80 | 70 | 56 |

^a Basic minimum hourly volume
^b Used for combination of Conditions A and B after adequate trial of other remedial measures
^c May be used when the major-street speed exceeds 40 mph or in an isolated community with a population of less than 10,000
^d May be used for combination of Conditions A and B after adequate trial of other remedial measures when the major-street speed exceeds 40 mph or in an isolated community with a population of less than 10,000

Figure 6-1: MUTCD Warrant 1 Volume Thresholds

This warrant was utilized as a screening tool, as its volume thresholds are the lowest of the three warrants. In the screening process, the AM and PM peak hour minor street volumes were compared with the minimum threshold for these movements. As the minor streets have a single lane provided for through/left turning vehicles, the threshold of 75 vehicles per hour was utilized. **Since this intersection does not meet the minimum threshold in the peak hour, Warrant 1 is not met. Therefore, it was determined that a signal is not warranted at this location.**

7. ICE POLICY

In accordance with GDOT Policy 4A-5, an Intersection Control Evaluation (ICE) review was performed for the intersection of US 23/SR 365/Cornelia Highway at the proposed driveway. The ICE tool is used to evaluate GDOT intersection control alternatives and identify a solution that both meets the project purpose and reflects the overall best value in terms of specific performance-based criteria. ICE assesses various factors – traffic, safety, cost, environmental impact, and stakeholder pressure – prior to providing scores. This is accomplished in two stages: the first stage is a screening effort to eliminate options that are not feasible and identify alternatives for further consideration; the second step is a detailed evaluation of the feasible alternatives identified in the first stage and is used to support the selection of the preferred alternative. Only one alternative, the RCUT configuration, was deemed to be appropriate from the ICE Stage 1. Therefore, according to guidance from the ICE tool, a waiver is appropriate and submitted in lieu of completing ICE Stage 2. ICE Stage 1 and a Waiver Request Form are included in the **Appendix**.

8. CAPACITY ANALYSIS

Capacity analysis in this study was performed utilizing methodologies contained in the Highway Capacity Manual (HCM), 6th Edition in Synchro. Capacity is defined as the maximum number of vehicles that can pass over a particular road segment or through a particular intersection within a specified period under prevailing roadway, traffic, and control conditions. Level of Service (LOS) is used to describe the operating characteristics of a road segment or intersection in relation to its capacity. LOS is defined as a qualitative measure that describes operational conditions and motorists’ perceptions. The Highway Capacity Manual defines six levels of service, LOS A through LOS F. Level of service A indicates excellent operations with little delay to motorists, while level of service F indicates extremely long delay.

Level of service for unsignalized intersections is calculated for the average controlled delay incurred for vehicles on the stop-controlled approaches. Controlled delay for unsignalized intersections includes initial deceleration delay, queue move-up time, stopped delay, and final acceleration delay. Several factors affect the controlled delay for unsignalized intersections, including the availability of gaps in the cross-street traffic, and acceptable gap time to make the movement from the stop position. The level-of-service criteria for unsignalized intersections is presented in **Table 8-1**. For stop-controlled intersections, LOS E and F exist when there are insufficient gaps in traffic, resulting in long delays. Low level of service for stop-controlled approaches are not uncommon at major cross-streets.

Table 8-1: Level of Service Thresholds

| | Unsignalized Intersections | Signalized Intersections |
|-----|----------------------------|--------------------------|
| LOS | Average Delay (seconds) | Average Delay (seconds) |
| A | <= 10 | <= 10 |
| B | > 10 and <= 15 | > 10 and <= 20 |
| C | > 15 and <= 25 | > 20 and <= 35 |
| D | > 25 and <= 35 | > 35 and <= 55 |
| E | > 35 and <= 50 | > 55 and <= 80 |
| F | > 50 | > 80 |

Source: 2010 Highway Capacity Manual

The capacity analysis utilized existing peak hour factors and existing heavy vehicle percentage from the collected traffic count data. The analyses are based on the existing lane designations since no programmed roadway improvements were assumed in this study. However, for the intersection of US 23/SR 365/Cornelia Highway at the site access point/median break, the build conditions analysis is based on the proposed RCUT intersection configuration selected in the ICE process. **Table 8-2** summarizes the results of the capacity analyses. No-Build conditions reflect existing roadway conditions with future forecasted traffic volumes minus the trips associated with the proposed development. Build conditions reflect the traffic control detailed within Table 8-2 with future forecasted traffic volumes and the trips associated with the proposed development added to the surrounding roadway network. Synchro outputs for all capacity analysis performed in this study are included in the **Appendix**.

Table 8-2: HCM Capacity Analysis Results

| Intersection | Existing Control | Build Condition Control | 2022 Existing | | 2023 | | | | 2028 | | | |
|---|--------------------------|-------------------------|----------------|----------------|----------------|----------------|----------------|----------------|----------------|----------------|----------------|----------------|
| | | | AM LOS (Delay) | PM LOS (Delay) | No Build | | Build | | No Build | | Build | |
| | | | | | AM LOS (Delay) | PM LOS (Delay) | AM LOS (Delay) | PM LOS (Delay) | AM LOS (Delay) | PM LOS (Delay) | AM LOS (Delay) | PM LOS (Delay) |
| 1 US 23/SR 365/Cornelia Hwy at Americold Logistics Dwy/Proposed Dwy | Side Street Stop Control | RCUT | *F | F (264.6) | *F | F (351.4) | E (44.3) | F (120.0) | *F | F (470.7) | F (75.3) | F (281.1) |
| 2 Cagle Mill Rd at Cagle Rd | Side Street Stop | Side Street Stop | A (8.7) | A (8.7) | A (8.7) | A (8.7) | A (8.7) | A (8.7) | A (8.7) | A (8.7) | A (8.7) | A (8.7) |
| 3 Julian Baugh Rd at Cagle Rd | Side Street Stop | Side Street Stop | A (8.7) | A (9.0) | A (8.7) | A (9.1) | A (8.7) | A (8.9) | A (8.8) | A (9.2) | A (8.7) | A (9.0) |
| 4 Cagle Mill Rd/Noah Martin Rd at Whitehall Rd | Side Street Stop | Side Street Stop | A (9.2) | A (9.2) | A (9.2) | A (9.2) | A (9.2) | A (9.4) | A (9.2) | A (9.3) | A (9.3) | A (9.4) |
| 5 Noah Martin Rd at Old Cornelia Hwy | Side Street Stop | Side Street Stop | B (11.2) | B (11.3) | B (11.3) | B (11.4) | B (11.4) | B (11.6) | B (12.0) | B (12.0) | B (12.1) | B (12.4) |
| 6 US 23/SR 365/Cornelia Hwy at Cagle Rd | Side Street Stop | Side Street Stop | *F | *F | *F | *F | *F | *F | *F | *F | *F | *F |
| 7 Cagle Mill Rd at Proposed Driveway | Side Street Stop | Side Street Stop | N/A | N/A | N/A | N/A | A (8.5) | A (8.5) | N/A | N/A | A (8.5) | A (8.5) |
| 8 US 23/SR 365/Cornelia Hwy at Median U turn | N/A | Side Street Stop | N/A | N/A | N/A | N/A | B (10.6) | E (41.2) | N/A | N/A | B (11.6) | F (72.3) |
| 9 US 23/SR 365/Cornelia Hwy at Median U turn | N/A | Side Street Stop | N/A | N/A | N/A | N/A | F (66.9) | B (13.0) | N/A | N/A | F (170.0) | B (15.0) |
| 8 Whitehall Rd at Proposed Driveway | N/A | Side Street Stop | N/A | N/A | N/A | N/A | A (8.7) | A (8.4) | N/A | N/A | A (8.7) | A (8.4) |

*Indicates delay greater than 500 seconds.

The results show that all intersections are operating effectively, at LOS B or better, with the exception of four intersections. US 23/SR 365/Cornelia Highway at Americold Logistics Driveway/Proposed Driveway and US 23/SR 365/Cornelia Highway at Cagle Road operate at LOS F in the existing and future no-build and build scenarios. The proposed median U-turn to be located north of the US 23/SR 365/Cornelia Highway at Americold Logistics Driveway/Proposed Driveway intersection will operate at a LOS F in the AM peak hour of the 2023/2028 built-out year scenarios. Meanwhile, the proposed median U-turn to be located south of the US 23/SR 365/Cornelia Highway at Americold Logistics Driveway/Proposed Driveway intersection will operate at a LOS F in the PM peak hour of the 2028 built-out year scenario.

Although the build condition results in a LOS F in the built-out year, the Restricted Crossing U-turn (RCUT) alternative US 23/SR 365/Cornelia Highway at Americold Logistics Driveway/Proposed Driveway the proposed intersection of US 23/SR 365/Cornelia Highway at Americold Logistics Driveway/Proposed Driveway significantly reduces vehicle delay at the intersection. In addition, this alternative enhances safety especially for drivers on the minor street approaches making a left turn movement. Since the left turn movements out of the minor street would be restricted, the RCUT alternative presents reduced opportunities for crashes.

9. CONCLUSION AND RECOMMENDATIONS

9.1 Conclusions

This traffic impact study evaluated the impact of Residence at Cagle Mill development in Hall County developing approximately 297 single-family houses and 86 low-rise multifamily residential units, which include 61 townhomes and 51 cluster homes. The proposed development is expected to generate 240 trips in AM peak hour and 318 trips in the PM peak hour.

This traffic impact study evaluated existing and future traffic conditions at study area intersections, both with and without further development at the project location. The findings of this analysis indicate that the development will not have a detrimental effect on adjacent intersections.

- The intersections of US 23/SR 365/Cornelia Highway at Americold Logistics Driveway/Proposed Driveway and US 23/SR 365/Cornelia Highway at Cagle Road are currently experiencing significant delay in both the AM and PM hours and have a failing LOS without any additional development. Due to the intersections failing without additional project traffic, the addition of traffic from the development does not pose significant impacts on the intersections.
- The intersection of US 23/SR 365/Cornelia Highway at Americold Logistics Driveway/Proposed Driveway is recommended to be modified to a RCUT, restricting vehicles exiting the cold storage facility and the proposed development from making left turn movements onto US 23/SR 365/Cornelia Highway. This recommendation would make the intersection safer by removing the conflict points associated with a left turning vehicle having to cross four lanes of traffic. Furthermore, this intersection modification would also significantly reduce delay at this intersection.
- The proposed site access on Cagle Mill Road is proposed to be a full access driveway with a shared left turn/right turn lane on the eastbound approach. The northbound approach is proposed to be a shared through/left turn lane while the southbound approach is proposed to be a shared through/right turn lane. This configuration operates at a LOS A in the 2023 opening year and 2028 design year.
- The proposed site access on Whitehall Road is proposed to be a full access driveway with a shared left turn/right turn lane on the southbound approach. The eastbound approach is proposed to be a shared through/left turn lane while the westbound approach is proposed to be a shared through/right turn lane. This configuration operates at a LOS A in the 2023 opening year and 2028 design year.

There are two additional outparcels shown on the development site plan in which commercial businesses such as retail or fast-food chain might be considered. These commercial businesses would generate trips that would utilize the main access road, increasing traffic volumes and impacting the intersection of US 23/SR 365/Cornelia Highway at Americold Logistics Driveway/Proposed Driveway. Because of this, the installation of a traffic signal in the future may be considered.

9.2 Recommendations

- Install a site access point on the east leg of the existing US 23/SR 365/Cornelia Highway at Americold Logistics. Convert the intersection to a Restricted Crossing U-Turn Configuration with the build out of the proposed development, maintaining existing left and right turn lanes along US 23/SR 365/Cornelia Highway.
- Install a site access point along Cagle Mill Road with full access operating under minor street stop control. The recommended intersection geometry is a shared left turn/right turn lane on the eastbound approach, a shared through/left turn lane on the northbound approach, and a shared through/right turn lane on the southbound approach.
- Install a site access point along Whitehall Road with full access operating under minor street stop control. The recommended intersection geometry is a shared left turn/right turn lane on the southbound approach, a shared through/left turn lane on the eastbound approach, and a shared through/right turn lane on the westbound approach.

Appendix

A. Project Location

B. Proposed Development Site Plan

C. Traffic Count Map

D. Collected Traffic Counts

E. Historic Traffic Counts

F. Existing Year and Future Year Build and No-Build Volumes

G. Truck Percentage Calculation Chart

H. COVID-19 Factor Calculation

I. Trip Generation

J. Trip Distribution

K. Capacity Analysis

L. ICE Analysis

APPENDIX

Appendix A: Project Location



Appendix B:

Proposed Development Site Plan

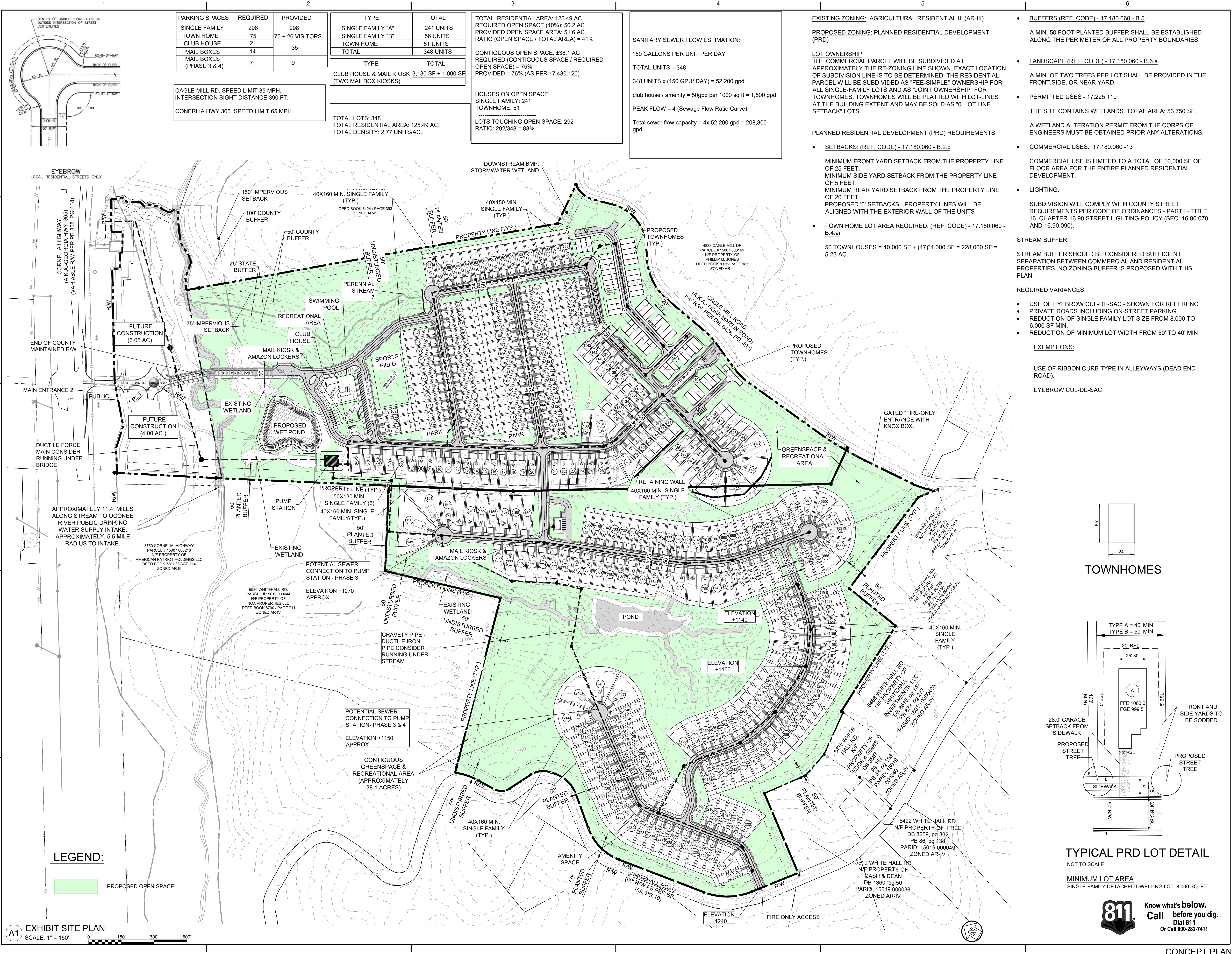

| PARKING SPACES | REQUIRED | PROVIDED |
|--------------------------|----------|------------------|
| SINGLE FAMILY | 298 | 298 |
| TOWN HOME | 75 | 75 + 26 VISITORS |
| CLUB HOUSE | 21 | |
| MAIL BOXES | 14 | 35 |
| MAIL BOXES (PHASE 3 & 4) | 7 | 9 |

| TYPE | TOTAL |
|-------------------|-----------|
| SINGLE FAMILY "A" | 241 UNITS |
| SINGLE FAMILY "B" | 56 UNITS |
| TOWN HOME | 51 UNITS |
| TOTAL | 348 UNITS |

| TYPE | TOTAL |
|--|---------------------|
| CLUB HOUSE & MAIL KIOSK (TWO MAILBOX KIOSKS) | 3,130 SF + 1,000 SF |

CAGLE MILL RD. SPEED LIMIT 35 MPH.
INTERSECTION SIGHT DISTANCE 390 FT.
CONERLIA HWY 365. SPEED LIMIT 65 MPH

TOTAL LOTS: 348
TOTAL RESIDENTIAL AREA: 125.49 AC.
TOTAL DENSITY: 2.77 UNITS/AC.

CONTIGUOUS OPEN SPACE: ±38.1 AC
REQUIRED (CONTIGUOUS SPACE / REQUIRED OPEN SPACE) = 75%
PROVIDED = 76% (AS PER 17.430.120)

HOUSES ON OPEN SPACE
SINGLE FAMILY: 241
TOWNHOME: 51

LOTS TOUCHING OPEN SPACE: 292
RATIO: 292/348 = 83%

SANITARY SEWER FLOW ESTIMATION:
150 GALLONS PER UNIT PER DAY
TOTAL UNITS = 348
348 UNITS x (150 GPM/UNIT) = 52,200 gpd
club house / amenity = 50gpd per 1000 sq ft = 1,500 gpd
PEAK FLOW = 4 (Sewage Flow Ratio Curve)
Total sewer flow capacity = 4x 52,200 gpd = 208,800 gpd

EXISTING ZONING: AGRICULTURAL RESIDENTIAL III (AR-III)
PROPOSED ZONING: PLANNED RESIDENTIAL DEVELOPMENT (PRD)
LOT OWNERSHIP
THE COMMERCIAL PARCEL WILL BE SUBDIVIDED AT APPROXIMATELY THE RE-ZONING LINE SHOWN. EXACT LOCATION OF SUBDIVISION LINE IS TO BE DETERMINED. THE RESIDENTIAL PARCEL WILL BE SUBDIVIDED AS "FEE-SIMPLE" OWNERSHIP FOR ALL SINGLE-FAMILY LOTS AND AS "JOINT OWNERSHIP" FOR TOWNHOMES. TOWNHOMES WILL BE PLATTED WITH LOT-LINES AT THE BUILDING EXTENT AND MAY BE SOLD AS "0' LOT LINE SETBACK" LOTS.

PLANNED RESIDENTIAL DEVELOPMENT (PRD) REQUIREMENTS:
• SETBACKS: (REF. CODE) - 17.180.060 - B.2.c
MINIMUM FRONT YARD SETBACK FROM THE PROPERTY LINE OF 25 FEET.
MINIMUM SIDE YARD SETBACK FROM THE PROPERTY LINE OF 5 FEET.
MINIMUM REAR YARD SETBACK FROM THE PROPERTY LINE OF 20 FEET.
PROPOSED '0' SETBACKS - PROPERTY LINES WILL BE ALIGNED WITH THE EXTERIOR WALL OF THE UNITS
• TOWN HOME LOT AREA REQUIRED: (REF. CODE) - 17.180.060 - B.4.ai
50 TOWNHOUSES = 40,000 SF + (47)*4,000 SF = 228,000 SF = 5.23 AC.

- BUFFERS (REF. CODE) - 17.180.060 - B.5
A MIN. 50 FOOT PLANTED BUFFER SHALL BE ESTABLISHED ALONG THE PERIMETER OF ALL PROPERTY BOUNDARIES
- LANDSCAPE (REF. CODE) - 17.180.060 - B.6.a
A MIN. OF TWO TREES PER LOT SHALL BE PROVIDED IN THE FRONT, SIDE, OR REAR YARD.
- PERMITTED USES - 17.225.110
THE SITE CONTAINS WETLANDS. TOTAL AREA: 53,750 SF.
A WETLAND ALTERATION PERMIT FROM THE CORPS OF ENGINEERS MUST BE OBTAINED PRIOR ANY ALTERATIONS.
- COMMERCIAL USES. 17.180.060 -13
COMMERCIAL USE IS LIMITED TO A TOTAL OF 10,000 SF OF FLOOR AREA FOR THE ENTIRE PLANNED RESIDENTIAL DEVELOPMENT.
- LIGHTING.
SUBDIVISION WILL COMPLY WITH COUNTY STREET REQUIREMENTS PER CODE OF ORDINANCES - PART 1 - TITLE 16, CHAPTER 16.90 STREET LIGHTING POLICY (SEC. 16.90.070 AND 16.90.090).
- STREAM BUFFER.
STREAM BUFFER SHOULD BE CONSIDERED SUFFICIENT SEPARATION BETWEEN COMMERCIAL AND RESIDENTIAL PROPERTIES. NO ZONING BUFFER IS PROPOSED WITH THIS PLAN.
- REQUIRED VARIANCES:
• USE OF EYEBROW CUL-DE-SAC - SHOWN FOR REFERENCE
• PRIVATE ROADS INCLUDING ON-STREET PARKING
• REDUCTION OF SINGLE FAMILY LOT SIZE FROM 8,000 TO 6,000 SF MIN.
• REDUCTION OF MINIMUM LOT WIDTH FROM 50' TO 40' MIN
- EXEMPTIONS:
USE OF RIBBON CURB TYPE IN ALLEYS (DEAD END ROAD).
EYEBROW CUL-DE-SAC

POND
3500 Parkway Lane
Suite 500
Peachtree Corners
Georgia 30092
Copyright © 2022 by Pond & Company, All rights reserved. No copying or distribution of these documents is allowed without the express written agreement of Pond & Company.

EOR/AOR SEAL

CLIENT INFORMATION



6525 The Corners Parkway
Suite 216
Peachtree Corners
Georgia 30092

PROJECT NAME

RESIDENCE AT
CAGLE MILL

4745 CAGLE MILL
ROAD, LULA,
GEORGIA

DRAWING ISSUE

DATE

DESCRIPTION

MARK

DESIGNED BY: WM
DRAWN BY: ABC
CHECKED BY: JBB
SUBMITTED BY: JBB
DATE: 12/12/23
PROJECT #: 1220263
SHEET TITLE

ZONING
SITE PLAN

SHEET NUMBER
CS-101

ORIGINAL SHEET SIZE:
30" X 42"

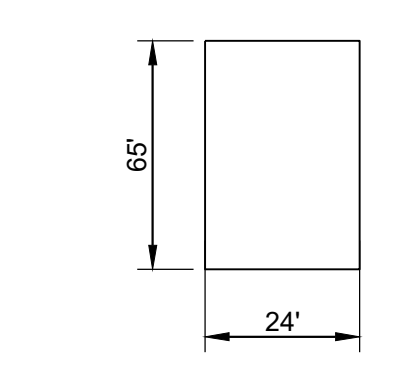

TOWNHOMES

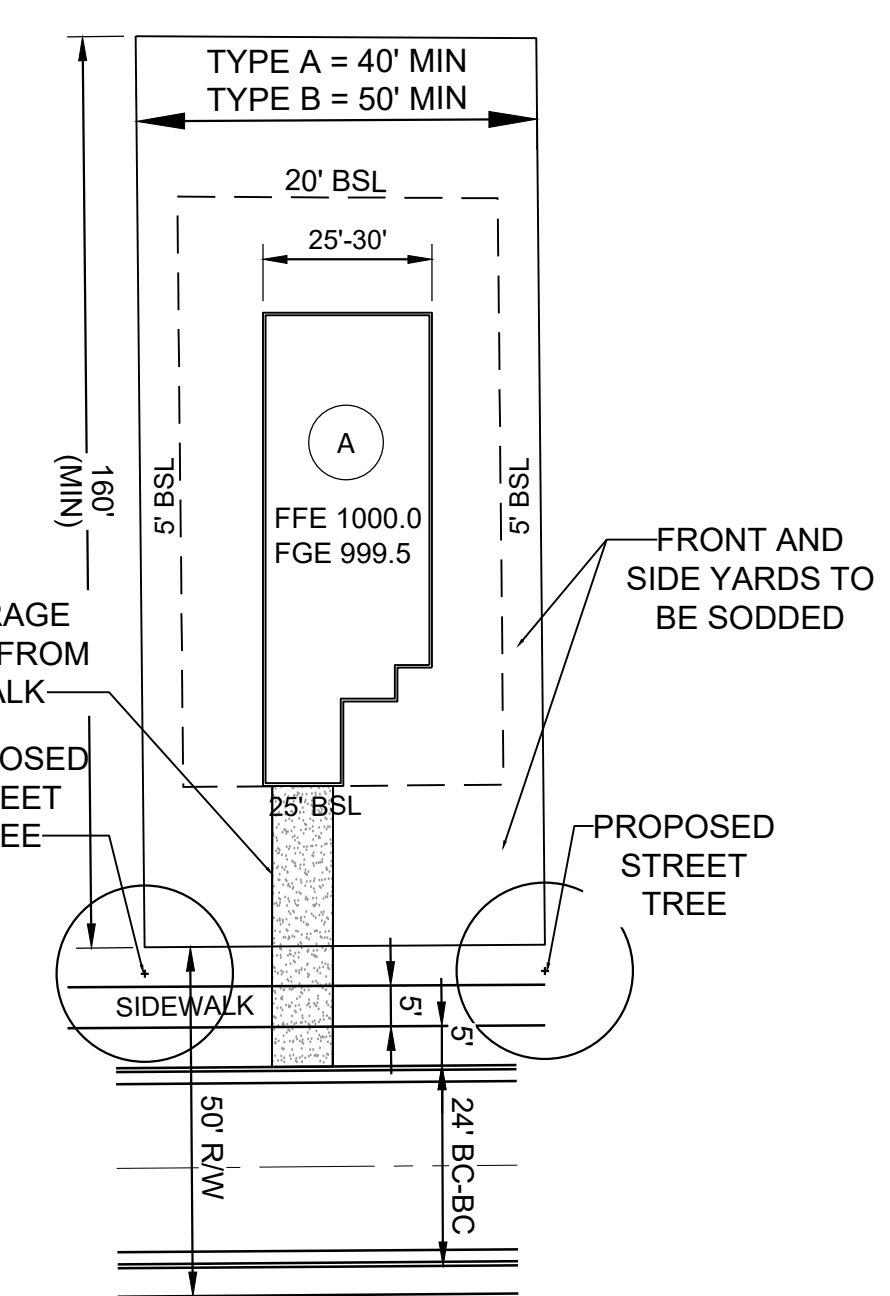

TYPICAL PRD LOT DETAIL
NOT TO SCALE.

MINIMUM LOT AREA
SINGLE-FAMILY DETACHED DWELLING LOT: 8,000 SQ. FT.



Know what's below.
Call before you dig.
Dial 811
Or Call 800-282-7411

LEGEND:



A1 EXHIBIT SITE PLAN
SCALE: 1" = 150'

FILE PATH: X:\FY22\1220263\04_CAD_BIM\04.02_CAD\CS101_PLOTTED BY: HU, KAI SHUN, DATE: 5/19/21

CONCEPT PLAN

Appendix C: Traffic Count Map

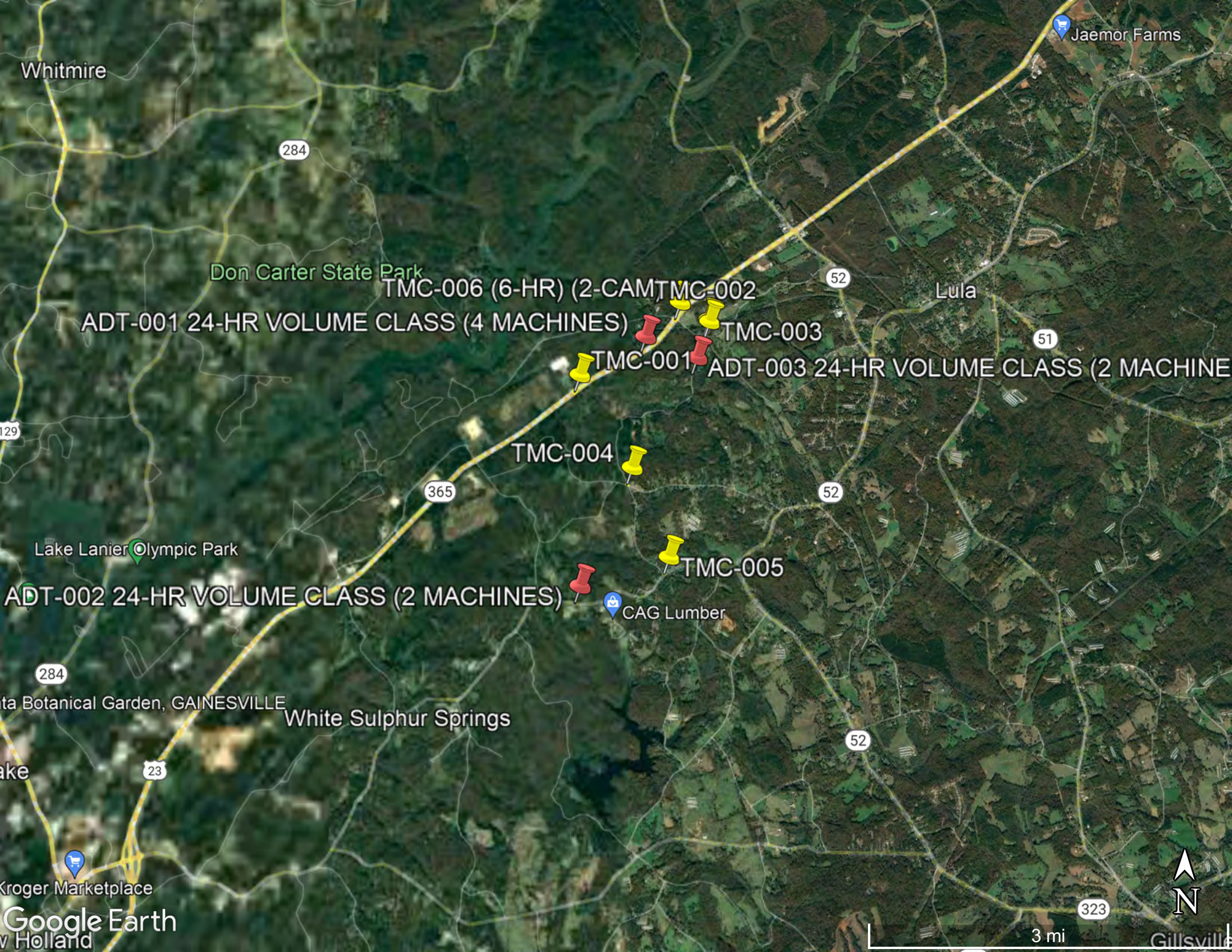

Whitmire

Jaemor Farms

284

Don Carter State Park

52

Lula

TMC-006 (6-HR) (2-CAM)

TMC-002

ADT-001 24-HR VOLUME CLASS (4 MACHINES)

TMC-003

51

TMC-001

ADT-003 24-HR VOLUME CLASS (2 MACHINES)

129

TMC-004

365

52

Lake Lanier Olympic Park

TMC-005

ADT-002 24-HR VOLUME CLASS (2 MACHINES)

CAG Lumber

284

Florida Botanical Garden, GAINESVILLE

White Sulphur Springs

52

Lake

23

Kroger Marketplace

Google Earth

W. Holland

3 mi

323

Gillsville



Appendix D: Collected Traffic Counts

National Data & Surveying Services Intersection Turning Movement Count

Location: US 23/SR 365/Cornelia Hwy & Americold Logistics Access Dwy
 City: Lula
 Control: 1-Way Stop (EB)

Project ID: 22-180056-001
 Date: 3/30/2022

Data - Total

| NS/EW Streets: | US 23/SR 365/Cornelia Hwy | | | | US 23/SR 365/Cornelia Hwy | | | | Americold Logistics Access Dwy | | | | Americold Logistics Access Dwy | | | | |
|-----------------|---------------------------|---------|---------|---------|---------------------------|---------|---------|---------|--------------------------------|---------|---------|---------|--------------------------------|---------|---------|---------|-------|
| AM | NORTHBOUND | | | | SOUTHBOUND | | | | EASTBOUND | | | | WESTBOUND | | | | TOTAL |
| | 1 NL | 2 NT | 0 NR | 0 NU | 1 SL | 2 ST | 1 SR | 0 SU | 0 EL | 1 ET | 1 ER | 0 EU | 0 WL | 0 WT | 0 WR | 0 WU | |
| 7:00 AM | 7 | 149 | 0 | 1 | 0 | 417 | 3 | 0 | 0 | 0 | 2 | 0 | 0 | 0 | 0 | 0 | 579 |
| 7:15 AM | 9 | 203 | 0 | 0 | 0 | 562 | 2 | 0 | 0 | 0 | 1 | 0 | 0 | 0 | 0 | 0 | 777 |
| 7:30 AM | 17 | 232 | 0 | 0 | 0 | 606 | 11 | 1 | 1 | 0 | 4 | 0 | 0 | 0 | 0 | 0 | 872 |
| 7:45 AM | 20 | 183 | 0 | 0 | 0 | 473 | 9 | 0 | 1 | 0 | 8 | 0 | 0 | 0 | 0 | 0 | 694 |
| 8:00 AM | 8 | 205 | 0 | 0 | 0 | 423 | 9 | 0 | 4 | 0 | 4 | 0 | 0 | 0 | 0 | 0 | 653 |
| 8:15 AM | 5 | 228 | 0 | 0 | 0 | 378 | 0 | 0 | 4 | 0 | 0 | 0 | 0 | 0 | 0 | 0 | 615 |
| 8:30 AM | 3 | 168 | 0 | 0 | 0 | 342 | 0 | 0 | 1 | 0 | 2 | 0 | 0 | 0 | 0 | 0 | 516 |
| 8:45 AM | 7 | 220 | 0 | 1 | 0 | 305 | 3 | 0 | 1 | 0 | 3 | 0 | 0 | 0 | 0 | 0 | 540 |
| 9:00 AM | 4 | 196 | 0 | 0 | 0 | 295 | 0 | 0 | 0 | 0 | 2 | 0 | 0 | 0 | 0 | 0 | 497 |
| 9:15 AM | 1 | 193 | 0 | 2 | 0 | 273 | 0 | 0 | 1 | 0 | 1 | 0 | 0 | 0 | 0 | 0 | 471 |
| 9:30 AM | 0 | 206 | 0 | 0 | 0 | 251 | 0 | 1 | 0 | 0 | 3 | 0 | 0 | 0 | 0 | 0 | 461 |
| 9:45 AM | 4 | 173 | 0 | 0 | 0 | 274 | 2 | 0 | 1 | 0 | 0 | 0 | 0 | 0 | 0 | 0 | 454 |
| TOTAL VOLUMES: | NL | NT | NR | NU | SL | ST | SR | SU | EL | ET | ER | EU | WL | WT | WR | WU | TOTAL |
| APPROACH %'s: | 85 | 2356 | 0 | 4 | 0 | 4599 | 39 | 2 | 14 | 0 | 30 | 0 | 0 | 0 | 0 | 0 | 7129 |
| | 3.48% | 96.36% | 0.00% | 0.16% | 0.00% | 99.12% | 0.84% | 0.04% | 31.82% | 0.00% | 68.18% | 0.00% | 0 | 0 | 0 | 0 | |
| PEAK HR: | 07:15 AM - 08:15 AM | | | | | | | | | | | | | | | | TOTAL |
| PEAK HR VOL: | 54 | 823 | 0 | 0 | 0 | 2064 | 31 | 1 | 6 | 0 | 17 | 0 | 0 | 0 | 0 | 0 | 2996 |
| PEAK HR FACTOR: | 0.675 | 0.887 | 0.000 | 0.000 | 0.000 | 0.851 | 0.705 | 0.250 | 0.375 | 0.000 | 0.531 | 0.000 | 0.000 | 0.000 | 0.000 | 0.000 | 0.859 |
| | | | | | | | 0.848 | | | | 0.639 | | | | | | |
| NOON | NORTHBOUND | | | | SOUTHBOUND | | | | EASTBOUND | | | | WESTBOUND | | | | TOTAL |
| 1 NL | 2 NT | 0 NR | 0 NU | 1 SL | 2 ST | 1 SR | 0 SU | 0 EL | 1 ET | 1 ER | 0 EU | 0 WL | 0 WT | 0 WR | 0 WU | | |
| 10:00 AM | 0 | 182 | 0 | 0 | 0 | 269 | 1 | 0 | 1 | 0 | 3 | 0 | 0 | 0 | 0 | 0 | 456 |
| 10:15 AM | 5 | 218 | 0 | 0 | 0 | 269 | 1 | 0 | 0 | 0 | 4 | 0 | 0 | 0 | 0 | 0 | 497 |
| 10:30 AM | 1 | 226 | 0 | 0 | 0 | 290 | 0 | 0 | 0 | 0 | 3 | 0 | 0 | 0 | 0 | 0 | 520 |
| 10:45 AM | 2 | 222 | 0 | 0 | 0 | 265 | 2 | 0 | 0 | 0 | 6 | 0 | 0 | 0 | 0 | 0 | 497 |
| 11:00 AM | 2 | 213 | 0 | 2 | 0 | 260 | 0 | 0 | 1 | 0 | 0 | 0 | 0 | 0 | 0 | 0 | 478 |
| 11:15 AM | 6 | 257 | 0 | 0 | 0 | 237 | 3 | 0 | 2 | 0 | 7 | 0 | 0 | 0 | 0 | 0 | 512 |
| 11:30 AM | 0 | 273 | 0 | 1 | 0 | 249 | 0 | 0 | 1 | 0 | 1 | 0 | 0 | 0 | 0 | 0 | 525 |
| 11:45 AM | 4 | 255 | 0 | 0 | 0 | 224 | 0 | 0 | 2 | 0 | 1 | 0 | 0 | 0 | 0 | 0 | 486 |
| 12:00 PM | 3 | 248 | 0 | 2 | 0 | 264 | 1 | 0 | 2 | 0 | 4 | 0 | 0 | 0 | 0 | 0 | 524 |
| 12:15 PM | 2 | 259 | 0 | 1 | 0 | 260 | 0 | 0 | 0 | 0 | 7 | 0 | 0 | 0 | 0 | 0 | 529 |
| 12:30 PM | 1 | 241 | 0 | 1 | 0 | 239 | 0 | 0 | 1 | 0 | 3 | 0 | 0 | 0 | 0 | 0 | 486 |
| 12:45 PM | 3 | 280 | 0 | 3 | 0 | 268 | 0 | 1 | 1 | 0 | 4 | 0 | 0 | 0 | 0 | 0 | 560 |
| 1:00 PM | 2 | 307 | 0 | 0 | 0 | 256 | 0 | 1 | 0 | 0 | 3 | 0 | 0 | 0 | 0 | 0 | 569 |
| 1:15 PM | 2 | 285 | 0 | 0 | 0 | 279 | 1 | 0 | 2 | 0 | 3 | 0 | 0 | 0 | 0 | 0 | 572 |
| 1:30 PM | 7 | 297 | 0 | 1 | 0 | 257 | 0 | 0 | 1 | 0 | 7 | 0 | 0 | 0 | 0 | 0 | 570 |
| 1:45 PM | 3 | 314 | 0 | 0 | 0 | 252 | 4 | 0 | 0 | 0 | 1 | 0 | 0 | 0 | 0 | 0 | 574 |
| TOTAL VOLUMES: | NL | NT | NR | NU | SL | ST | SR | SU | EL | ET | ER | EU | WL | WT | WR | WU | TOTAL |
| APPROACH %'s: | 43 | 4077 | 0 | 11 | 0 | 4138 | 13 | 2 | 14 | 0 | 57 | 0 | 0 | 0 | 0 | 0 | 8355 |
| | 1.04% | 98.69% | 0.00% | 0.27% | 0.00% | 99.64% | 0.31% | 0.05% | 19.72% | 0.00% | 80.28% | 0.00% | 0 | 0 | 0 | 0 | |
| PEAK HR: | 01:00 PM - 02:00 PM | | | | | | | | | | | | | | | | TOTAL |
| PEAK HR VOL: | 14 | 1203 | 0 | 1 | 0 | 1044 | 5 | 1 | 3 | 0 | 14 | 0 | 0 | 0 | 0 | 0 | 2285 |
| PEAK HR FACTOR: | 0.500 | 0.958 | 0.000 | 0.250 | 0.000 | 0.935 | 0.313 | 0.250 | 0.375 | 0.000 | 0.500 | 0.000 | 0.000 | 0.000 | 0.000 | 0.000 | 0.995 |
| | | | | | | | 0.938 | | | | 0.531 | | | | | | |
| PM | NORTHBOUND | | | | SOUTHBOUND | | | | EASTBOUND | | | | WESTBOUND | | | | TOTAL |
| 1 NL | 2 NT | 0 NR | 0 NU | 1 SL | 2 ST | 1 SR | 0 SU | 0 EL | 1 ET | 1 ER | 0 EU | 0 WL | 0 WT | 0 WR | 0 WU | | |
| 2:00 PM | 2 | 286 | 0 | 1 | 0 | 246 | 2 | 0 | 1 | 0 | 1 | 0 | 0 | 0 | 0 | 0 | 539 |
| 2:15 PM | 4 | 346 | 0 | 0 | 0 | 264 | 4 | 0 | 0 | 0 | 2 | 0 | 0 | 0 | 0 | 0 | 620 |
| 2:30 PM | 0 | 369 | 0 | 0 | 0 | 261 | 1 | 0 | 0 | 0 | 3 | 0 | 0 | 0 | 0 | 0 | 654 |
| 2:45 PM | 3 | 370 | 0 | 0 | 0 | 239 | 0 | 0 | 0 | 0 | 3 | 0 | 0 | 0 | 0 | 0 | 615 |
| 3:00 PM | 2 | 405 | 0 | 0 | 0 | 243 | 0 | 0 | 0 | 0 | 2 | 0 | 0 | 0 | 0 | 0 | 652 |
| 3:15 PM | 2 | 426 | 0 | 1 | 0 | 261 | 3 | 0 | 4 | 0 | 5 | 0 | 0 | 0 | 0 | 0 | 702 |
| 3:30 PM | 6 | 475 | 0 | 0 | 0 | 216 | 2 | 0 | 3 | 0 | 5 | 0 | 0 | 0 | 0 | 0 | 707 |
| 3:45 PM | 11 | 514 | 0 | 0 | 0 | 253 | 6 | 0 | 1 | 0 | 2 | 0 | 0 | 0 | 0 | 0 | 787 |
| 4:00 PM | 7 | 451 | 0 | 0 | 0 | 231 | 3 | 0 | 6 | 0 | 7 | 0 | 0 | 0 | 0 | 0 | 705 |
| 4:15 PM | 6 | 569 | 0 | 0 | 0 | 261 | 1 | 0 | 0 | 0 | 3 | 0 | 0 | 0 | 0 | 0 | 840 |
| 4:30 PM | 2 | 486 | 0 | 0 | 0 | 249 | 2 | 0 | 4 | 0 | 11 | 0 | 0 | 0 | 0 | 0 | 754 |
| 4:45 PM | 3 | 571 | 0 | 0 | 0 | 252 | 3 | 0 | 3 | 0 | 5 | 0 | 0 | 0 | 0 | 0 | 837 |
| 5:00 PM | 1 | 559 | 0 | 0 | 0 | 219 | 3 | 0 | 6 | 0 | 10 | 0 | 0 | 0 | 0 | 0 | 798 |
| 5:15 PM | 1 | 605 | 0 | 0 | 0 | 278 | 1 | 1 | 6 | 0 | 5 | 0 | 0 | 0 | 0 | 0 | 897 |
| 5:30 PM | 1 | 622 | 0 | 0 | 0 | 237 | 1 | 1 | 3 | 0 | 4 | 0 | 0 | 0 | 0 | 0 | 869 |
| 5:45 PM | 4 | 517 | 0 | 0 | 0 | 231 | 0 | 0 | 3 | 0 | 6 | 0 | 0 | 0 | 0 | 0 | 761 |
| 6:00 PM | 0 | 405 | 0 | 0 | 0 | 221 | 1 | 0 | 4 | 0 | 6 | 0 | 0 | 0 | 0 | 0 | 637 |
| 6:15 PM | 1 | 333 | 0 | 1 | 0 | 213 | 0 | 0 | 0 | 0 | 11 | 0 | 0 | 0 | 0 | 0 | 559 |
| 6:30 PM | 2 | 320 | 0 | 0 | 0 | 215 | 1 | 0 | 2 | 0 | 10 | 0 | 0 | 0 | 0 | 0 | 550 |
| 6:45 PM | 5 | 273 | 0 | 1 | 0 | 160 | 0 | 0 | 0 | 0 | 2 | 0 | 0 | 0 | 0 | 0 | 441 |
| TOTAL VOLUMES: | NL | NT | NR | NU | SL | ST | SR | SU | EL | ET | ER | EU | WL | WT | WR | WU | TOTAL |
| APPROACH %'s: | 63 | 8902 | 0 | 4 | 0 | 4770 | 34 | 2 | 46 | 0 | 103 | 0 | 0 | 0 | 0 | 0 | 13924 |
| | 0.70% | 99.25% | 0.00% | 0.04% | 0.00% | 99.25% | 0.71% | 0.04% | 30.87% | 0.00% | 69.13% | 0.00% | 0 | 0 | 0 | 0 | |
| PEAK HR: | 04:45 PM - 05:45 PM | | | | | | | | | | | | | | | | TOTAL |
| PEAK HR VOL: | 6 | 2357 | 0 | 0 | 0 | 986 | 8 | 2 | 18 | 0 | 24 | 0 | 0 | 0 | 0 | 0 | 3401 |
| PEAK HR FACTOR: | 0.500 | 0.947 | 0.000 | 0.000 | 0.000 | 0.887 | 0.667 | 0.500 | 0.750 | 0.000 | 0.600 | 0.000 | 0.000 | 0.000 | 0.000 | 0.000 | 0.948 |
| | | | | | | | 0.889 | | | | 0.656 | | | | | | |

National Data & Surveying Services Intersection Turning Movement Count

Location: US 23/SR 365/Cornelia Hwy & Americold Logistics Access Dwy
 City: Lula
 Control: 1-Way Stop (EB)

Project ID: 22-180056-001
 Date: 3/30/2022

Data - Cars

| NS/EW Streets: | US 23/SR 365/Cornelia Hwy | | | | US 23/SR 365/Cornelia Hwy | | | | Americold Logistics Access Dwy | | | | Americold Logistics Access Dwy | | | | |
|-----------------|---------------------------|---------|---------|---------|---------------------------|---------|---------|---------|--------------------------------|---------|---------|---------|--------------------------------|---------|---------|---------|-------|
| AM | NORTHBOUND | | | | SOUTHBOUND | | | | EASTBOUND | | | | WESTBOUND | | | | TOTAL |
| | 1 NL | 2 NT | 0 NR | 0 NU | 1 SL | 2 ST | 1 SR | 0 SU | 0 EL | 1 ET | 1 ER | 0 EU | 0 WL | 0 WT | 0 WR | 0 WU | |
| 7:00 AM | 7 | 131 | 0 | 1 | 0 | 401 | 2 | 0 | 0 | 0 | 2 | 0 | 0 | 0 | 0 | 0 | 544 |
| 7:15 AM | 9 | 179 | 0 | 0 | 0 | 542 | 2 | 0 | 0 | 0 | 1 | 0 | 0 | 0 | 0 | 0 | 733 |
| 7:30 AM | 15 | 216 | 0 | 0 | 0 | 583 | 11 | 1 | 1 | 0 | 4 | 0 | 0 | 0 | 0 | 0 | 831 |
| 7:45 AM | 19 | 168 | 0 | 0 | 0 | 446 | 9 | 0 | 1 | 0 | 6 | 0 | 0 | 0 | 0 | 0 | 649 |
| 8:00 AM | 5 | 172 | 0 | 0 | 0 | 403 | 8 | 0 | 4 | 0 | 2 | 0 | 0 | 0 | 0 | 0 | 594 |
| 8:15 AM | 4 | 197 | 0 | 0 | 0 | 345 | 0 | 0 | 4 | 0 | 0 | 0 | 0 | 0 | 0 | 0 | 550 |
| 8:30 AM | 2 | 143 | 0 | 0 | 0 | 320 | 0 | 0 | 1 | 0 | 0 | 0 | 0 | 0 | 0 | 0 | 466 |
| 8:45 AM | 2 | 189 | 0 | 1 | 0 | 277 | 1 | 0 | 1 | 0 | 1 | 0 | 0 | 0 | 0 | 0 | 472 |
| 9:00 AM | 1 | 174 | 0 | 0 | 0 | 272 | 0 | 0 | 0 | 0 | 0 | 0 | 0 | 0 | 0 | 0 | 447 |
| 9:15 AM | 0 | 164 | 0 | 2 | 0 | 257 | 0 | 0 | 0 | 0 | 0 | 0 | 0 | 0 | 0 | 0 | 423 |
| 9:30 AM | 0 | 176 | 0 | 0 | 0 | 231 | 0 | 1 | 0 | 0 | 1 | 0 | 0 | 0 | 0 | 0 | 409 |
| 9:45 AM | 3 | 149 | 0 | 0 | 0 | 241 | 0 | 0 | 0 | 0 | 0 | 0 | 0 | 0 | 0 | 0 | 393 |
| TOTAL VOLUMES: | NL | NT | NR | NU | SL | ST | SR | SU | EL | ET | ER | EU | WL | WT | WR | WU | TOTAL |
| APPROACH %'s: | 3.15% | 96.67% | 0.00% | 0.19% | 0.00% | 99.20% | 0.76% | 0.05% | 41.38% | 0.00% | 58.62% | 0.00% | 0 | 0 | 0 | 0 | 6511 |
| PEAK HR: | 07:15 AM - 08:15 AM | | | | | | | | | | | | | | | | TOTAL |
| PEAK HR VOL: | 48 | 735 | 0 | 0 | 0 | 1974 | 30 | 1 | 6 | 0 | 13 | 0 | 0 | 0 | 0 | 0 | 2807 |
| PEAK HR FACTOR: | 0.632 | 0.851 | 0.000 | 0.000 | 0.000 | 0.846 | 0.682 | 0.250 | 0.375 | 0.000 | 0.542 | 0.000 | 0.000 | 0.000 | 0.000 | 0.000 | 0.844 |
| | 0.847 | | | | 0.842 | | | | 0.679 | | | | | | | | |
| NOON | NORTHBOUND | | | | SOUTHBOUND | | | | EASTBOUND | | | | WESTBOUND | | | | TOTAL |
| | 1 NL | 2 NT | 0 NR | 0 NU | 1 SL | 2 ST | 1 SR | 0 SU | 0 EL | 1 ET | 1 ER | 0 EU | 0 WL | 0 WT | 0 WR | 0 WU | |
| 10:00 AM | 0 | 150 | 0 | 0 | 0 | 242 | 1 | 0 | 1 | 0 | 1 | 0 | 0 | 0 | 0 | 0 | 395 |
| 10:15 AM | 1 | 191 | 0 | 0 | 0 | 240 | 0 | 0 | 0 | 0 | 2 | 0 | 0 | 0 | 0 | 0 | 434 |
| 10:30 AM | 0 | 191 | 0 | 0 | 0 | 268 | 0 | 0 | 0 | 0 | 2 | 0 | 0 | 0 | 0 | 0 | 461 |
| 10:45 AM | 1 | 199 | 0 | 0 | 0 | 244 | 2 | 0 | 0 | 0 | 2 | 0 | 0 | 0 | 0 | 0 | 448 |
| 11:00 AM | 1 | 196 | 0 | 2 | 0 | 229 | 0 | 0 | 0 | 0 | 0 | 0 | 0 | 0 | 0 | 0 | 428 |
| 11:15 AM | 2 | 223 | 0 | 0 | 0 | 209 | 0 | 0 | 0 | 0 | 6 | 0 | 0 | 0 | 0 | 0 | 440 |
| 11:30 AM | 0 | 246 | 0 | 1 | 0 | 219 | 0 | 0 | 0 | 0 | 0 | 0 | 0 | 0 | 0 | 0 | 466 |
| 11:45 AM | 1 | 226 | 0 | 0 | 0 | 201 | 0 | 0 | 1 | 0 | 1 | 0 | 0 | 0 | 0 | 0 | 430 |
| 12:00 PM | 1 | 218 | 0 | 2 | 0 | 235 | 1 | 0 | 1 | 0 | 2 | 0 | 0 | 0 | 0 | 0 | 460 |
| 12:15 PM | 1 | 238 | 0 | 1 | 0 | 237 | 0 | 0 | 0 | 0 | 4 | 0 | 0 | 0 | 0 | 0 | 481 |
| 12:30 PM | 1 | 216 | 0 | 1 | 0 | 219 | 0 | 0 | 0 | 0 | 0 | 0 | 0 | 0 | 0 | 0 | 437 |
| 12:45 PM | 2 | 256 | 0 | 3 | 0 | 243 | 0 | 1 | 0 | 0 | 3 | 0 | 0 | 0 | 0 | 0 | 508 |
| 1:00 PM | 1 | 278 | 0 | 0 | 0 | 226 | 0 | 1 | 0 | 0 | 2 | 0 | 0 | 0 | 0 | 0 | 508 |
| 1:15 PM | 0 | 263 | 0 | 0 | 0 | 249 | 0 | 0 | 2 | 0 | 1 | 0 | 0 | 0 | 0 | 0 | 515 |
| 1:30 PM | 5 | 268 | 0 | 1 | 0 | 240 | 0 | 0 | 1 | 0 | 2 | 0 | 0 | 0 | 0 | 0 | 517 |
| 1:45 PM | 1 | 290 | 0 | 0 | 0 | 232 | 3 | 0 | 0 | 0 | 0 | 0 | 0 | 0 | 0 | 0 | 526 |
| TOTAL VOLUMES: | NL | NT | NR | NU | SL | ST | SR | SU | EL | ET | ER | EU | WL | WT | WR | WU | TOTAL |
| APPROACH %'s: | 0.49% | 99.21% | 0.00% | 0.30% | 0.00% | 99.76% | 0.19% | 0.05% | 17.65% | 0.00% | 82.35% | 0.00% | 0 | 0 | 0 | 0 | 7454 |
| PEAK HR: | 01:00 PM - 02:00 PM | | | | | | | | | | | | | | | | TOTAL |
| PEAK HR VOL: | 7 | 1099 | 0 | 1 | 0 | 947 | 3 | 1 | 3 | 0 | 5 | 0 | 0 | 0 | 0 | 0 | 2066 |
| PEAK HR FACTOR: | 0.350 | 0.947 | 0.000 | 0.250 | 0.000 | 0.951 | 0.250 | 0.250 | 0.375 | 0.000 | 0.625 | 0.000 | 0.000 | 0.000 | 0.000 | 0.000 | 0.982 |
| | 0.951 | | | | 0.955 | | | | 0.667 | | | | | | | | |
| PM | NORTHBOUND | | | | SOUTHBOUND | | | | EASTBOUND | | | | WESTBOUND | | | | TOTAL |
| | 1 NL | 2 NT | 0 NR | 0 NU | 1 SL | 2 ST | 1 SR | 0 SU | 0 EL | 1 ET | 1 ER | 0 EU | 0 WL | 0 WT | 0 WR | 0 WU | |
| 2:00 PM | 1 | 270 | 0 | 1 | 0 | 218 | 0 | 0 | 1 | 0 | 0 | 0 | 0 | 0 | 0 | 0 | 491 |
| 2:15 PM | 1 | 320 | 0 | 0 | 0 | 241 | 2 | 0 | 0 | 0 | 2 | 0 | 0 | 0 | 0 | 0 | 566 |
| 2:30 PM | 0 | 350 | 0 | 0 | 0 | 253 | 1 | 0 | 0 | 0 | 2 | 0 | 0 | 0 | 0 | 0 | 606 |
| 2:45 PM | 2 | 337 | 0 | 0 | 0 | 223 | 0 | 0 | 0 | 0 | 2 | 0 | 0 | 0 | 0 | 0 | 564 |
| 3:00 PM | 0 | 379 | 0 | 0 | 0 | 216 | 0 | 0 | 0 | 0 | 2 | 0 | 0 | 0 | 0 | 0 | 597 |
| 3:15 PM | 1 | 400 | 0 | 1 | 0 | 231 | 3 | 0 | 3 | 0 | 2 | 0 | 0 | 0 | 0 | 0 | 641 |
| 3:30 PM | 6 | 455 | 0 | 0 | 0 | 198 | 2 | 0 | 3 | 0 | 3 | 0 | 0 | 0 | 0 | 0 | 667 |
| 3:45 PM | 8 | 485 | 0 | 0 | 0 | 228 | 5 | 0 | 0 | 0 | 2 | 0 | 0 | 0 | 0 | 0 | 728 |
| 4:00 PM | 5 | 426 | 0 | 0 | 0 | 212 | 3 | 0 | 6 | 0 | 6 | 0 | 0 | 0 | 0 | 0 | 658 |
| 4:15 PM | 5 | 545 | 0 | 0 | 0 | 235 | 0 | 0 | 0 | 0 | 2 | 0 | 0 | 0 | 0 | 0 | 787 |
| 4:30 PM | 2 | 474 | 0 | 0 | 0 | 227 | 2 | 0 | 4 | 0 | 9 | 0 | 0 | 0 | 0 | 0 | 718 |
| 4:45 PM | 3 | 540 | 0 | 0 | 0 | 228 | 3 | 0 | 3 | 0 | 4 | 0 | 0 | 0 | 0 | 0 | 781 |
| 5:00 PM | 1 | 535 | 0 | 0 | 0 | 198 | 2 | 0 | 4 | 0 | 8 | 0 | 0 | 0 | 0 | 0 | 748 |
| 5:15 PM | 1 | 581 | 0 | 0 | 0 | 261 | 1 | 1 | 6 | 0 | 4 | 0 | 0 | 0 | 0 | 0 | 855 |
| 5:30 PM | 0 | 603 | 0 | 0 | 0 | 222 | 1 | 1 | 3 | 0 | 2 | 0 | 0 | 0 | 0 | 0 | 832 |
| 5:45 PM | 1 | 505 | 0 | 0 | 0 | 213 | 0 | 0 | 3 | 0 | 4 | 0 | 0 | 0 | 0 | 0 | 726 |
| 6:00 PM | 0 | 392 | 0 | 0 | 0 | 200 | 0 | 0 | 4 | 0 | 1 | 0 | 0 | 0 | 0 | 0 | 597 |
| 6:15 PM | 0 | 327 | 0 | 1 | 0 | 196 | 0 | 0 | 0 | 0 | 9 | 0 | 0 | 0 | 0 | 0 | 533 |
| 6:30 PM | 2 | 310 | 0 | 0 | 0 | 200 | 0 | 0 | 2 | 0 | 9 | 0 | 0 | 0 | 0 | 0 | 523 |
| 6:45 PM | 3 | 265 | 0 | 1 | 0 | 144 | 0 | 0 | 0 | 0 | 1 | 0 | 0 | 0 | 0 | 0 | 414 |
| TOTAL VOLUMES: | NL | NT | NR | NU | SL | ST | SR | SU | EL | ET | ER | EU | WL | WT | WR | WU | TOTAL |
| APPROACH %'s: | 0.49% | 99.46% | 0.00% | 0.05% | 0.00% | 99.38% | 0.57% | 0.05% | 36.21% | 0.00% | 63.79% | 0.00% | 0 | 0 | 0 | 0 | 13032 |
| PEAK HR: | 04:45 PM - 05:45 PM | | | | | | | | | | | | | | | | TOTAL |
| PEAK HR VOL: | 5 | 2259 | 0 | 0 | 0 | 909 | 7 | 2 | 16 | 0 | 18 | 0 | 0 | 0 | 0 | 0 | 3216 |
| PEAK HR FACTOR: | 0.417 | 0.937 | 0.000 | 0.000 | 0.000 | 0.871 | 0.583 | 0.500 | 0.667 | 0.000 | 0.563 | 0.000 | 0.000 | 0.000 | 0.000 | 0.000 | 0.940 |
| | 0.939 | | | | 0.873 | | | | 0.708 | | | | | | | | |

National Data & Surveying Services Intersection Turning Movement Count

Location: US 23/SR 365/Cornelia Hwy & Americold Logistics Access Dwy
 City: Lula
 Control: 1-Way Stop (EB)

Project ID: 22-180056-001
 Date: 3/30/2022

Data - Bikes

| NS/EW Streets: | US 23/SR 365/Cornelia Hwy | | | | US 23/SR 365/Cornelia Hwy | | | | Americold Logistics Access Dwy | | | | Americold Logistics Access Dwy | | | | | |
|-----------------------------------|---------------------------|---------|---------|---------|---------------------------|---------|---------|---------|--------------------------------|---------|---------|---------|--------------------------------|---------|---------|---------|------------|------------|
| AM | NORTHBOUND | | | | SOUTHBOUND | | | | EASTBOUND | | | | WESTBOUND | | | | TOTAL | |
| | 1 NL | 2 NT | 0 NR | 0 NU | 1 SL | 2 ST | 1 SR | 0 SU | 0 EL | 1 ET | 1 ER | 0 EU | 0 WL | 0 WT | 0 WR | 0 WU | | |
| 7:00 AM | 0 | 0 | 0 | 0 | 0 | 0 | 0 | 0 | 0 | 0 | 0 | 0 | 0 | 0 | 0 | 0 | 0 | |
| 7:15 AM | 0 | 0 | 0 | 0 | 0 | 0 | 0 | 0 | 0 | 0 | 0 | 0 | 0 | 0 | 0 | 0 | 0 | |
| 7:30 AM | 0 | 0 | 0 | 0 | 0 | 0 | 0 | 0 | 0 | 0 | 0 | 0 | 0 | 0 | 0 | 0 | 0 | |
| 7:45 AM | 0 | 0 | 0 | 0 | 0 | 0 | 0 | 0 | 0 | 0 | 0 | 0 | 0 | 0 | 0 | 0 | 0 | |
| 8:00 AM | 0 | 0 | 0 | 0 | 0 | 0 | 0 | 0 | 0 | 0 | 0 | 0 | 0 | 0 | 0 | 0 | 0 | |
| 8:15 AM | 0 | 0 | 0 | 0 | 0 | 0 | 0 | 0 | 0 | 0 | 0 | 0 | 0 | 0 | 0 | 0 | 0 | |
| 8:30 AM | 0 | 0 | 0 | 0 | 0 | 0 | 0 | 0 | 0 | 0 | 0 | 0 | 0 | 0 | 0 | 0 | 0 | |
| 8:45 AM | 0 | 0 | 0 | 0 | 0 | 0 | 0 | 0 | 0 | 0 | 0 | 0 | 0 | 0 | 0 | 0 | 0 | |
| 9:00 AM | 0 | 0 | 0 | 0 | 0 | 0 | 0 | 0 | 0 | 0 | 0 | 0 | 0 | 0 | 0 | 0 | 0 | |
| 9:15 AM | 0 | 0 | 0 | 0 | 0 | 0 | 0 | 0 | 0 | 0 | 0 | 0 | 0 | 0 | 0 | 0 | 0 | |
| 9:30 AM | 0 | 0 | 0 | 0 | 0 | 0 | 0 | 0 | 0 | 0 | 0 | 0 | 0 | 0 | 0 | 0 | 0 | |
| 9:45 AM | 0 | 0 | 0 | 0 | 0 | 0 | 0 | 0 | 0 | 0 | 0 | 0 | 0 | 0 | 0 | 0 | 0 | |
| TOTAL VOLUMES : APPROACH %'s : | NL 0 | NT 0 | NR 0 | NU 0 | SL 0 | ST 0 | SR 0 | SU 0 | EL 0 | ET 0 | ER 0 | EU 0 | WL 0 | WT 0 | WR 0 | WU 0 | TOTAL 0 | |
| PEAK HR : | 07:15 AM - 08:15 AM | | | | | | | | | | | | | | | | TOTAL | |
| PEAK HR VOL : | 0 | 0 | 0 | 0 | 0 | 0 | 0 | 0 | 0 | 0 | 0 | 0 | 0 | 0 | 0 | 0 | 0 | TOTAL 0 |
| PEAK HR FACTOR : | 0.000 | 0.000 | 0.000 | 0.000 | 0.000 | 0.000 | 0.000 | 0.000 | 0.000 | 0.000 | 0.000 | 0.000 | 0.000 | 0.000 | 0.000 | 0.000 | 0.000 | |
| NOON | NORTHBOUND | | | | SOUTHBOUND | | | | EASTBOUND | | | | WESTBOUND | | | | TOTAL | |
| | 1 NL | 2 NT | 0 NR | 0 NU | 1 SL | 2 ST | 1 SR | 0 SU | 0 EL | 1 ET | 1 ER | 0 EU | 0 WL | 0 WT | 0 WR | 0 WU | | |
| 10:00 AM | 0 | 0 | 0 | 0 | 0 | 0 | 0 | 0 | 0 | 0 | 0 | 0 | 0 | 0 | 0 | 0 | 0 | |
| 10:15 AM | 0 | 0 | 0 | 0 | 0 | 0 | 0 | 0 | 0 | 0 | 0 | 0 | 0 | 0 | 0 | 0 | 0 | |
| 10:30 AM | 0 | 0 | 0 | 0 | 0 | 0 | 0 | 0 | 0 | 0 | 0 | 0 | 0 | 0 | 0 | 0 | 0 | |
| 10:45 AM | 0 | 0 | 0 | 0 | 0 | 0 | 0 | 0 | 0 | 0 | 0 | 0 | 0 | 0 | 0 | 0 | 0 | |
| 11:00 AM | 0 | 0 | 0 | 0 | 0 | 0 | 0 | 0 | 0 | 0 | 0 | 0 | 0 | 0 | 0 | 0 | 0 | |
| 11:15 AM | 0 | 0 | 0 | 0 | 0 | 0 | 0 | 0 | 0 | 0 | 0 | 0 | 0 | 0 | 0 | 0 | 0 | |
| 11:30 AM | 0 | 0 | 0 | 0 | 0 | 0 | 0 | 0 | 0 | 0 | 0 | 0 | 0 | 0 | 0 | 0 | 0 | |
| 11:45 AM | 0 | 0 | 0 | 0 | 0 | 0 | 0 | 0 | 0 | 0 | 0 | 0 | 0 | 0 | 0 | 0 | 0 | |
| 12:00 PM | 0 | 0 | 0 | 0 | 0 | 0 | 0 | 0 | 0 | 0 | 0 | 0 | 0 | 0 | 0 | 0 | 0 | |
| 12:15 PM | 0 | 0 | 0 | 0 | 0 | 0 | 0 | 0 | 0 | 0 | 0 | 0 | 0 | 0 | 0 | 0 | 0 | |
| 12:30 PM | 0 | 0 | 0 | 0 | 0 | 0 | 0 | 0 | 0 | 0 | 0 | 0 | 0 | 0 | 0 | 0 | 0 | |
| 12:45 PM | 0 | 0 | 0 | 0 | 0 | 0 | 0 | 0 | 0 | 0 | 0 | 0 | 0 | 0 | 0 | 0 | 0 | |
| 1:00 PM | 0 | 0 | 0 | 0 | 0 | 0 | 0 | 0 | 0 | 0 | 0 | 0 | 0 | 0 | 0 | 0 | 0 | |
| 1:15 PM | 0 | 0 | 0 | 0 | 0 | 0 | 0 | 0 | 0 | 0 | 0 | 0 | 0 | 0 | 0 | 0 | 0 | |
| 1:30 PM | 0 | 0 | 0 | 0 | 0 | 0 | 0 | 0 | 0 | 0 | 0 | 0 | 0 | 0 | 0 | 0 | 0 | |
| 1:45 PM | 0 | 0 | 0 | 0 | 0 | 0 | 0 | 0 | 0 | 0 | 0 | 0 | 0 | 0 | 0 | 0 | 0 | |
| TOTAL VOLUMES : APPROACH %'s : | NL 0 | NT 0 | NR 0 | NU 0 | SL 0 | ST 0 | SR 0 | SU 0 | EL 0 | ET 0 | ER 0 | EU 0 | WL 0 | WT 0 | WR 0 | WU 0 | TOTAL 0 | |
| PEAK HR : | 01:00 PM - 02:00 PM | | | | | | | | | | | | | | | | TOTAL | |
| PEAK HR VOL : | 0 | 0 | 0 | 0 | 0 | 0 | 0 | 0 | 0 | 0 | 0 | 0 | 0 | 0 | 0 | 0 | 0 | TOTAL 0 |
| PEAK HR FACTOR : | 0.000 | 0.000 | 0.000 | 0.000 | 0.000 | 0.000 | 0.000 | 0.000 | 0.000 | 0.000 | 0.000 | 0.000 | 0.000 | 0.000 | 0.000 | 0.000 | 0.000 | |
| PM | NORTHBOUND | | | | SOUTHBOUND | | | | EASTBOUND | | | | WESTBOUND | | | | TOTAL | |
| | 1 NL | 2 NT | 0 NR | 0 NU | 1 SL | 2 ST | 1 SR | 0 SU | 0 EL | 1 ET | 1 ER | 0 EU | 0 WL | 0 WT | 0 WR | 0 WU | | |
| 2:00 PM | 0 | 0 | 0 | 0 | 0 | 0 | 0 | 0 | 0 | 0 | 0 | 0 | 0 | 0 | 0 | 0 | 0 | |
| 2:15 PM | 0 | 0 | 0 | 0 | 0 | 0 | 0 | 0 | 0 | 0 | 0 | 0 | 0 | 0 | 0 | 0 | 0 | |
| 2:30 PM | 0 | 0 | 0 | 0 | 0 | 0 | 0 | 0 | 0 | 0 | 0 | 0 | 0 | 0 | 0 | 0 | 0 | |
| 2:45 PM | 0 | 0 | 0 | 0 | 0 | 0 | 0 | 0 | 0 | 0 | 0 | 0 | 0 | 0 | 0 | 0 | 0 | |
| 3:00 PM | 0 | 0 | 0 | 0 | 0 | 0 | 0 | 0 | 0 | 0 | 0 | 0 | 0 | 0 | 0 | 0 | 0 | |
| 3:15 PM | 0 | 0 | 0 | 0 | 0 | 0 | 0 | 0 | 0 | 0 | 0 | 0 | 0 | 0 | 0 | 0 | 0 | |
| 3:30 PM | 0 | 0 | 0 | 0 | 0 | 0 | 0 | 0 | 0 | 0 | 0 | 0 | 0 | 0 | 0 | 0 | 0 | |
| 3:45 PM | 0 | 0 | 0 | 0 | 0 | 0 | 0 | 0 | 0 | 0 | 0 | 0 | 0 | 0 | 0 | 0 | 0 | |
| 4:00 PM | 0 | 0 | 0 | 0 | 0 | 0 | 0 | 0 | 0 | 0 | 0 | 0 | 0 | 0 | 0 | 0 | 0 | |
| 4:15 PM | 0 | 0 | 0 | 0 | 0 | 0 | 0 | 0 | 0 | 0 | 0 | 0 | 0 | 0 | 0 | 0 | 0 | |
| 4:30 PM | 0 | 0 | 0 | 0 | 0 | 0 | 0 | 0 | 0 | 0 | 0 | 0 | 0 | 0 | 0 | 0 | 0 | |
| 4:45 PM | 0 | 0 | 0 | 0 | 0 | 0 | 0 | 0 | 0 | 0 | 0 | 0 | 0 | 0 | 0 | 0 | 0 | |
| 5:00 PM | 0 | 0 | 0 | 0 | 0 | 0 | 0 | 0 | 0 | 0 | 0 | 0 | 0 | 0 | 0 | 0 | 0 | |
| 5:15 PM | 0 | 0 | 0 | 0 | 0 | 0 | 0 | 0 | 0 | 0 | 0 | 0 | 0 | 0 | 0 | 0 | 0 | |
| 5:30 PM | 0 | 0 | 0 | 0 | 0 | 0 | 0 | 0 | 0 | 0 | 0 | 0 | 0 | 0 | 0 | 0 | 0 | |
| 5:45 PM | 0 | 0 | 0 | 0 | 0 | 0 | 0 | 0 | 0 | 0 | 0 | 0 | 0 | 0 | 0 | 0 | 0 | |
| 6:00 PM | 0 | 0 | 0 | 0 | 0 | 0 | 0 | 0 | 0 | 0 | 0 | 0 | 0 | 0 | 0 | 0 | 0 | |
| 6:15 PM | 0 | 0 | 0 | 0 | 0 | 0 | 0 | 0 | 0 | 0 | 0 | 0 | 0 | 0 | 0 | 0 | 0 | |
| 6:30 PM | 0 | 0 | 0 | 0 | 0 | 0 | 0 | 0 | 0 | 0 | 0 | 0 | 0 | 0 | 0 | 0 | 0 | |
| 6:45 PM | 0 | 0 | 0 | 0 | 0 | 0 | 0 | 0 | 0 | 0 | 0 | 0 | 0 | 0 | 0 | 0 | 0 | |
| TOTAL VOLUMES : APPROACH %'s : | NL 0 | NT 0 | NR 0 | NU 0 | SL 0 | ST 0 | SR 0 | SU 0 | EL 0 | ET 0 | ER 0 | EU 0 | WL 0 | WT 0 | WR 0 | WU 0 | TOTAL 0 | |
| PEAK HR : | 04:45 PM - 05:45 PM | | | | | | | | | | | | | | | | TOTAL | |
| PEAK HR VOL : | 0 | 0 | 0 | 0 | 0 | 0 | 0 | 0 | 0 | 0 | 0 | 0 | 0 | 0 | 0 | 0 | 0 | TOTAL 0 |
| PEAK HR FACTOR : | 0.000 | 0.000 | 0.000 | 0.000 | 0.000 | 0.000 | 0.000 | 0.000 | 0.000 | 0.000 | 0.000 | 0.000 | 0.000 | 0.000 | 0.000 | 0.000 | 0.000 | |

Project ID: 22-180056-001

Location: US 23/SR 365/Cornelia Hwy & Americold Logistics Access Dwy

City: Lula

Day: Wednesday

Date: 3/30/2022

Groups Printed - Cars, PU, Vans - Heavy Trucks

| Start Time | US 23/SR 365/Cornelia Hwy Northbound | | | | | | US 23/SR 365/Cornelia Hwy Southbound | | | | | | Americold Logistics Access Dwy Eastbound | | | | | | Americold Logistics Access Dwy Westbound | | | | | | Int. Total | | |
|-------------|--------------------------------------|------|-----|------|------|------------|--------------------------------------|------|-----|------|------|------------|--|------|-----|------|------|------------|--|------|-----|------|------|------------|------------|------|------|
| | Left | Thru | Rgt | Utum | Peds | App. Total | Left | Thru | Rgt | Utum | Peds | App. Total | Left | Thru | Rgt | Utum | Peds | App. Total | Left | Thru | Rgt | Utum | Peds | App. Total | | | |
| 7:00 AM | 7 | 149 | 0 | 1 | 0 | 157 | 0 | 417 | 3 | 0 | 0 | 420 | 0 | 0 | 2 | 0 | 0 | 2 | 0 | 0 | 0 | 0 | 0 | 0 | 0 | 579 | |
| 7:15 AM | 9 | 203 | 0 | 0 | 0 | 212 | 0 | 562 | 2 | 0 | 0 | 564 | 0 | 0 | 1 | 0 | 0 | 1 | 0 | 0 | 0 | 0 | 0 | 0 | 0 | 777 | |
| 7:30 AM | 17 | 232 | 0 | 0 | 0 | 249 | 0 | 606 | 11 | 1 | 0 | 618 | 1 | 0 | 4 | 0 | 0 | 5 | 0 | 0 | 0 | 0 | 0 | 0 | 0 | 872 | |
| 7:45 AM | 20 | 183 | 0 | 0 | 0 | 203 | 0 | 473 | 9 | 0 | 0 | 482 | 1 | 0 | 8 | 0 | 0 | 9 | 0 | 0 | 0 | 0 | 0 | 0 | 0 | 694 | |
| Total | 53 | 767 | 0 | 1 | 0 | 821 | 0 | 2058 | 25 | 1 | 0 | 2084 | 2 | 0 | 15 | 0 | 0 | 17 | 0 | 0 | 0 | 0 | 0 | 0 | 0 | 2922 | |
| 8:00 AM | 8 | 205 | 0 | 0 | 0 | 213 | 0 | 423 | 9 | 0 | 0 | 432 | 4 | 0 | 4 | 0 | 0 | 8 | 0 | 0 | 0 | 0 | 0 | 0 | 0 | 653 | |
| 8:15 AM | 5 | 228 | 0 | 0 | 0 | 233 | 0 | 378 | 0 | 0 | 0 | 378 | 4 | 0 | 0 | 0 | 0 | 4 | 0 | 0 | 0 | 0 | 0 | 0 | 0 | 615 | |
| 8:30 AM | 3 | 168 | 0 | 0 | 0 | 171 | 0 | 342 | 0 | 0 | 0 | 342 | 1 | 0 | 2 | 0 | 0 | 3 | 0 | 0 | 0 | 0 | 0 | 0 | 0 | 516 | |
| 8:45 AM | 7 | 220 | 0 | 1 | 0 | 228 | 0 | 305 | 3 | 0 | 0 | 308 | 1 | 0 | 3 | 0 | 0 | 4 | 0 | 0 | 0 | 0 | 0 | 0 | 0 | 540 | |
| Total | 23 | 821 | 0 | 1 | 0 | 845 | 0 | 1448 | 12 | 0 | 0 | 1460 | 10 | 0 | 9 | 0 | 0 | 19 | 0 | 0 | 0 | 0 | 0 | 0 | 0 | 2324 | |
| 9:00 AM | 4 | 196 | 0 | 0 | 0 | 200 | 0 | 295 | 0 | 0 | 0 | 295 | 0 | 0 | 2 | 0 | 0 | 2 | 0 | 0 | 0 | 0 | 0 | 0 | 0 | 497 | |
| 9:15 AM | 1 | 193 | 0 | 2 | 0 | 196 | 0 | 273 | 0 | 0 | 0 | 273 | 1 | 0 | 1 | 0 | 0 | 2 | 0 | 0 | 0 | 0 | 0 | 0 | 0 | 471 | |
| 9:30 AM | 0 | 206 | 0 | 0 | 0 | 206 | 0 | 251 | 0 | 1 | 0 | 252 | 0 | 0 | 3 | 0 | 0 | 3 | 0 | 0 | 0 | 0 | 0 | 0 | 0 | 461 | |
| 9:45 AM | 4 | 173 | 0 | 0 | 0 | 177 | 0 | 274 | 2 | 0 | 0 | 276 | 1 | 0 | 0 | 0 | 0 | 1 | 0 | 0 | 0 | 0 | 0 | 0 | 0 | 454 | |
| Total | 9 | 768 | 0 | 2 | 0 | 779 | 0 | 1093 | 2 | 1 | 0 | 1096 | 2 | 0 | 6 | 0 | 0 | 8 | 0 | 0 | 0 | 0 | 0 | 0 | 0 | 1883 | |
| ***BREAK*** | | | | | | | | | | | | | | | | | | | | | | | | | | | |
| 10:00 AM | 0 | 182 | 0 | 0 | 0 | 182 | 0 | 269 | 1 | 0 | 0 | 270 | 1 | 0 | 3 | 0 | 0 | 4 | 0 | 0 | 0 | 0 | 0 | 0 | 0 | 0 | 456 |
| 10:15 AM | 5 | 218 | 0 | 0 | 0 | 223 | 0 | 269 | 1 | 0 | 0 | 270 | 0 | 0 | 4 | 0 | 0 | 4 | 0 | 0 | 0 | 0 | 0 | 0 | 0 | 0 | 497 |
| 10:30 AM | 1 | 226 | 0 | 0 | 0 | 227 | 0 | 290 | 0 | 0 | 0 | 290 | 0 | 0 | 3 | 0 | 0 | 3 | 0 | 0 | 0 | 0 | 0 | 0 | 0 | 0 | 520 |
| 10:45 AM | 2 | 222 | 0 | 0 | 0 | 224 | 0 | 265 | 2 | 0 | 0 | 267 | 0 | 0 | 6 | 0 | 0 | 6 | 0 | 0 | 0 | 0 | 0 | 0 | 0 | 0 | 497 |
| Total | 8 | 848 | 0 | 0 | 0 | 856 | 0 | 1093 | 4 | 0 | 0 | 1097 | 1 | 0 | 16 | 0 | 0 | 17 | 0 | 0 | 0 | 0 | 0 | 0 | 0 | 0 | 1970 |
| 11:00 AM | 2 | 213 | 0 | 2 | 0 | 217 | 0 | 260 | 0 | 0 | 0 | 260 | 1 | 0 | 0 | 0 | 0 | 1 | 0 | 0 | 0 | 0 | 0 | 0 | 0 | 0 | 478 |
| 11:15 AM | 6 | 257 | 0 | 0 | 0 | 263 | 0 | 237 | 3 | 0 | 0 | 240 | 2 | 0 | 7 | 0 | 0 | 9 | 0 | 0 | 0 | 0 | 0 | 0 | 0 | 0 | 512 |
| 11:30 AM | 0 | 273 | 0 | 1 | 0 | 274 | 0 | 249 | 0 | 0 | 0 | 249 | 1 | 0 | 1 | 0 | 0 | 2 | 0 | 0 | 0 | 0 | 0 | 0 | 0 | 0 | 525 |
| 11:45 AM | 4 | 255 | 0 | 0 | 0 | 259 | 0 | 224 | 0 | 0 | 0 | 224 | 2 | 0 | 1 | 0 | 0 | 3 | 0 | 0 | 0 | 0 | 0 | 0 | 0 | 0 | 486 |
| Total | 12 | 998 | 0 | 3 | 0 | 1013 | 0 | 970 | 3 | 0 | 0 | 973 | 6 | 0 | 9 | 0 | 0 | 15 | 0 | 0 | 0 | 0 | 0 | 0 | 0 | 0 | 2001 |
| 12:00 PM | 3 | 248 | 0 | 2 | 0 | 253 | 0 | 264 | 1 | 0 | 0 | 265 | 2 | 0 | 4 | 0 | 0 | 6 | 0 | 0 | 0 | 0 | 0 | 0 | 0 | 0 | 524 |
| 12:15 PM | 2 | 259 | 0 | 1 | 0 | 262 | 0 | 260 | 0 | 0 | 0 | 260 | 0 | 0 | 7 | 0 | 0 | 7 | 0 | 0 | 0 | 0 | 0 | 0 | 0 | 0 | 529 |
| 12:30 PM | 1 | 241 | 0 | 1 | 0 | 243 | 0 | 239 | 0 | 0 | 0 | 239 | 1 | 0 | 3 | 0 | 0 | 4 | 0 | 0 | 0 | 0 | 0 | 0 | 0 | 0 | 486 |
| 12:45 PM | 3 | 280 | 0 | 3 | 0 | 286 | 0 | 268 | 0 | 1 | 0 | 269 | 1 | 0 | 4 | 0 | 0 | 5 | 0 | 0 | 0 | 0 | 0 | 0 | 0 | 0 | 560 |
| Total | 9 | 1028 | 0 | 7 | 0 | 1044 | 0 | 1031 | 1 | 1 | 0 | 1033 | 4 | 0 | 18 | 0 | 0 | 22 | 0 | 0 | 0 | 0 | 0 | 0 | 0 | 0 | 2099 |
| 1:00 PM | 2 | 307 | 0 | 0 | 0 | 309 | 0 | 256 | 0 | 1 | 0 | 257 | 0 | 0 | 3 | 0 | 0 | 3 | 0 | 0 | 0 | 0 | 0 | 0 | 0 | 0 | 569 |
| 1:15 PM | 2 | 285 | 0 | 0 | 0 | 287 | 0 | 279 | 1 | 0 | 0 | 280 | 2 | 0 | 3 | 0 | 0 | 5 | 0 | 0 | 0 | 0 | 0 | 0 | 0 | 0 | 572 |
| 1:30 PM | 7 | 297 | 0 | 1 | 0 | 305 | 0 | 257 | 0 | 0 | 0 | 257 | 1 | 0 | 7 | 0 | 0 | 8 | 0 | 0 | 0 | 0 | 0 | 0 | 0 | 0 | 570 |
| 1:45 PM | 3 | 314 | 0 | 0 | 0 | 317 | 0 | 252 | 4 | 0 | 0 | 257 | 0 | 0 | 1 | 0 | 0 | 1 | 0 | 0 | 0 | 0 | 0 | 0 | 0 | 0 | 574 |
| Total | 14 | 1203 | 0 | 1 | 0 | 1218 | 0 | 1044 | 5 | 1 | 0 | 1050 | 3 | 0 | 14 | 0 | 0 | 17 | 0 | 0 | 0 | 0 | 0 | 0 | 0 | 0 | 2285 |
| ***BREAK*** | | | | | | | | | | | | | | | | | | | | | | | | | | | |
| 2:00 PM | 2 | 286 | 0 | 1 | 0 | 289 | 0 | 246 | 2 | 0 | 0 | 248 | 1 | 0 | 1 | 0 | 0 | 2 | 0 | 0 | 0 | 0 | 0 | 0 | 0 | 0 | 539 |
| 2:15 PM | 4 | 346 | 0 | 0 | 0 | 350 | 0 | 264 | 4 | 0 | 0 | 268 | 0 | 0 | 2 | 0 | 0 | 2 | 0 | 0 | 0 | 0 | 0 | 0 | 0 | 0 | 620 |
| 2:30 PM | 0 | 369 | 0 | 0 | 0 | 369 | 0 | 281 | 1 | 0 | 0 | 282 | 0 | 0 | 3 | 0 | 0 | 3 | 0 | 0 | 0 | 0 | 0 | 0 | 0 | 0 | 654 |
| 2:45 PM | 3 | 370 | 0 | 0 | 0 | 373 | 0 | 239 | 0 | 0 | 0 | 239 | 0 | 0 | 3 | 0 | 0 | 3 | 0 | 0 | 0 | 0 | 0 | 0 | 0 | 0 | 615 |
| Total | 9 | 1371 | 0 | 1 | 0 | 1381 | 0 | 1030 | 7 | 0 | 0 | 1037 | 1 | 0 | 9 | 0 | 0 | 10 | 0 | 0 | 0 | 0 | 0 | 0 | 0 | 0 | 2428 |
| 3:00 PM | 2 | 405 | 0 | 0 | 0 | 407 | 0 | 243 | 0 | 0 | 0 | 243 | 0 | 0 | 2 | 0 | 0 | 2 | 0 | 0 | 0 | 0 | 0 | 0 | 0 | 0 | 652 |
| 3:15 PM | 2 | 426 | 0 | 1 | 0 | 429 | 0 | 261 | 3 | 0 | 0 | 264 | 4 | 0 | 5 | 0 | 0 | 9 | 0 | 0 | 0 | 0 | 0 | 0 | 0 | 0 | 702 |
| 3:30 PM | 6 | 475 | 0 | 0 | 0 | 481 | 0 | 216 | 2 | 0 | 0 | 218 | 3 | 0 | 5 | 0 | 0 | 8 | 0 | 0 | 0 | 0 | 0 | 0 | 0 | 0 | 707 |
| 3:45 PM | 11 | 514 | 0 | 0 | 0 | 525 | 0 | 253 | 6 | 0 | 0 | 259 | 1 | 0 | 2 | 0 | 0 | 3 | 0 | 0 | 0 | 0 | 0 | 0 | 0 | 0 | 787 |
| Total | 21 | 1820 | 0 | 1 | 0 | 1842 | 0 | 973 | 11 | 0 | 0 | 984 | 8 | 0 | 14 | 0 | 0 | 22 | 0 | 0 | 0 | 0 | 0 | 0 | 0 | 0 | 2848 |
| 4:00 PM | 7 | 451 | 0 | 0 | 0 | 458 | 0 | 231 | 3 | 0 | 0 | 234 | 6 | 0 | 7 | 0 | 0 | 13 | 0 | 0 | 0 | 0 | 0 | 0 | 0 | 0 | 705 |
| 4:15 PM | 6 | 569 | 0 | 0 | 0 | 575 | 0 | 261 | 1 | 0 | 0 | 262 | 0 | 0 | 3 | 0 | 0 | 3 | 0 | 0 | 0 | 0 | 0 | 0 | 0 | 0 | 840 |
| 4:30 PM | 2 | 486 | 0 | 0 | 0 | 488 | 0 | 249 | 2 | 0 | 0 | 251 | 4 | 0 | 11 | 0 | 0 | 15 | 0 | 0 | 0 | 0 | 0 | 0 | 0 | 0 | 754 |
| 4:45 PM | 3 | 571 | 0 | 0 | 0 | 574 | 0 | 252 | 3 | 0 | 0 | 255 | 3 | 0 | 5 | 0 | 0 | 8 | 0 | 0 | 0 | 0 | 0 | 0 | 0 | 0 | 837 |
| Total | 18 | 2077 | 0 | 0 | 0 | 2095 | 0 | 993 | 9 | 0 | 0 | 1002 | 13 | 0 | 26 | 0 | 0 | 39 | 0 | 0 | 0 | 0 | 0 | 0 | 0 | 0 | 3136 |
| 5:00 PM | 1 | 559 | 0 | 0 | 0 | 560 | 0 | 219 | 3 | 0 | 0 | 222 | 6 | 0 | 10 | 0 | 0 | 16 | 0 | 0 | 0 | 0 | 0 | 0 | 0 | 0 | 798 |
| 5:15 PM | 1 | 605 | 0 | 0 | 0 | 606 | 0 | 278 | 1 | 1 | 0 | 280 | 6 | 0 | 5 | 0 | 0 | 11 | 0 | 0 | 0 | 0 | 0 | 0 | 0 | 0 | 897 |
| 5:30 PM | 1 | 622 | 0 | 0 | 0 | 623 | 0 | 237 | 1 | 1 | 0 | 239 | 3 | 0 | 4 | 0 | 0 | 7 | 0 | 0 | 0 | 0 | 0 | 0 | 0 | 0 | 869 |
| 5:45 PM | 4 | 517 | 0 | 0 | 0 | 521 | 0 | 231 | 0 | 0 | 0 | 231 | 3 | 0 | 6 | 0 | 0 | 9 | 0 | 0 | 0 | 0 | 0 | 0 | 0 | 0 | 761 |
| Total | 7 | 2303 | 0 | 0 | 0 | 2310 | | | | | | | | | | | | | | | | | | | | | |

National Data & Surveying Services Intersection Turning Movement Count

Location: Cagle Mill Rd & Cagle Rd
 City: Lula
 Control: 1-Way Stop (NB)

Project ID: 22-180056-002
 Date: 3/30/2022

Data - Total

| NS/EW Streets: | Cagle Mill Rd | | | | Cagle Mill Rd | | | | Cagle Rd | | | | Cagle Rd | | | | | |
|-----------------|---------------------|-------|--------|-------|---------------|-------|-------|-------|-----------|--------|--------|-------|-----------|--------|-------|-------|-------|----|
| AM | NORTHBOUND | | | | SOUTHBOUND | | | | EASTBOUND | | | | WESTBOUND | | | | | |
| | NL | NT | NR | NU | SL | ST | SR | SU | EL | ET | ER | EU | WL | WT | WR | WU | TOTAL | |
| | 7:00 AM | 1 | 0 | 0 | 0 | 0 | 0 | 0 | 0 | 0 | 1 | 1 | 0 | 0 | 0 | 0 | 0 | 3 |
| | 7:15 AM | 7 | 0 | 0 | 0 | 0 | 0 | 0 | 0 | 0 | 0 | 0 | 0 | 0 | 0 | 0 | 0 | 7 |
| | 7:30 AM | 5 | 0 | 1 | 0 | 0 | 0 | 0 | 0 | 0 | 1 | 1 | 0 | 0 | 2 | 0 | 0 | 10 |
| | 7:45 AM | 3 | 0 | 0 | 0 | 0 | 0 | 0 | 0 | 0 | 0 | 0 | 0 | 2 | 1 | 0 | 0 | 6 |
| | 8:00 AM | 3 | 0 | 0 | 0 | 0 | 0 | 0 | 0 | 0 | 0 | 0 | 0 | 0 | 3 | 0 | 0 | 6 |
| | 8:15 AM | 3 | 0 | 0 | 0 | 0 | 0 | 0 | 0 | 0 | 1 | 3 | 0 | 0 | 0 | 0 | 0 | 7 |
| | 8:30 AM | 4 | 0 | 1 | 0 | 0 | 0 | 0 | 0 | 0 | 2 | 3 | 0 | 0 | 3 | 0 | 0 | 13 |
| | 8:45 AM | 3 | 0 | 0 | 0 | 0 | 0 | 0 | 0 | 0 | 0 | 0 | 0 | 0 | 0 | 0 | 0 | 3 |
| 9:00 AM | 1 | 0 | 0 | 0 | 0 | 0 | 0 | 0 | 0 | 1 | 2 | 0 | 0 | 0 | 0 | 0 | 4 | |
| 9:15 AM | 0 | 0 | 1 | 0 | 0 | 0 | 0 | 0 | 0 | 1 | 1 | 0 | 0 | 4 | 0 | 0 | 7 | |
| 9:30 AM | 3 | 0 | 1 | 0 | 0 | 0 | 0 | 0 | 0 | 0 | 4 | 0 | 0 | 0 | 0 | 0 | 8 | |
| 9:45 AM | 1 | 0 | 0 | 0 | 0 | 0 | 0 | 0 | 0 | 0 | 0 | 0 | 1 | 1 | 0 | 0 | 3 | |
| TOTAL VOLUMES: | NL | NT | NR | NU | SL | ST | SR | SU | EL | ET | ER | EU | WL | WT | WR | WU | TOTAL | |
| APPROACH %'s: | 89.47% | 0.00% | 10.53% | 0.00% | 0 | 0 | 0 | 0 | 0.00% | 31.82% | 68.18% | 0.00% | 17.65% | 82.35% | 0.00% | 0.00% | 77 | |
| PEAK HR: | 07:45 AM - 08:45 AM | | | | | | | | | | | | | | | | TOTAL | |
| PEAK HR VOL: | 13 | 0 | 0 | 0 | 0 | 0 | 0 | 0 | 0 | 3 | 6 | 0 | 2 | 7 | 0 | 0 | 32 | |
| PEAK HR FACTOR: | 0.813 | 0.000 | 0.250 | 0.000 | 0.000 | 0.000 | 0.000 | 0.000 | 0.000 | 0.375 | 0.500 | 0.000 | 0.250 | 0.583 | 0.000 | 0.000 | 0.615 | |
| | 0.700 | | | | | | | | 0.450 | | | | 0.750 | | | | | |
| NOON | NORTHBOUND | | | | SOUTHBOUND | | | | EASTBOUND | | | | WESTBOUND | | | | | |
| | NL | NT | NR | NU | SL | ST | SR | SU | EL | ET | ER | EU | WL | WT | WR | WU | TOTAL | |
| | 10:00 AM | 0 | 0 | 0 | 0 | 0 | 0 | 0 | 0 | 0 | 0 | 2 | 0 | 0 | 2 | 0 | 0 | 4 |
| | 10:15 AM | 1 | 0 | 0 | 0 | 0 | 0 | 0 | 0 | 0 | 1 | 3 | 0 | 0 | 0 | 0 | 0 | 5 |
| | 10:30 AM | 2 | 0 | 0 | 0 | 0 | 0 | 0 | 0 | 0 | 0 | 2 | 0 | 0 | 0 | 0 | 0 | 4 |
| | 10:45 AM | 3 | 0 | 2 | 1 | 0 | 0 | 0 | 0 | 0 | 1 | 1 | 0 | 1 | 1 | 0 | 0 | 10 |
| | 11:00 AM | 2 | 0 | 0 | 0 | 0 | 0 | 0 | 0 | 0 | 0 | 1 | 0 | 1 | 1 | 0 | 0 | 5 |
| | 11:15 AM | 9 | 0 | 0 | 0 | 0 | 0 | 0 | 0 | 0 | 0 | 4 | 0 | 0 | 1 | 0 | 0 | 14 |
| | 11:30 AM | 3 | 0 | 0 | 0 | 0 | 0 | 0 | 0 | 0 | 0 | 1 | 0 | 0 | 0 | 0 | 0 | 4 |
| | 11:45 AM | 5 | 0 | 0 | 0 | 0 | 0 | 0 | 0 | 0 | 1 | 1 | 0 | 0 | 0 | 0 | 0 | 7 |
| 12:00 PM | 2 | 0 | 0 | 0 | 0 | 0 | 0 | 0 | 0 | 2 | 3 | 0 | 0 | 1 | 0 | 0 | 8 | |
| 12:15 PM | 1 | 0 | 0 | 0 | 0 | 0 | 0 | 0 | 0 | 0 | 0 | 0 | 1 | 1 | 0 | 0 | 3 | |
| 12:30 PM | 2 | 0 | 0 | 0 | 0 | 0 | 0 | 0 | 0 | 1 | 6 | 0 | 0 | 0 | 0 | 0 | 9 | |
| 12:45 PM | 4 | 0 | 0 | 0 | 0 | 0 | 0 | 0 | 0 | 0 | 1 | 0 | 1 | 1 | 0 | 0 | 7 | |
| 1:00 PM | 4 | 0 | 0 | 0 | 0 | 0 | 0 | 0 | 0 | 2 | 2 | 0 | 0 | 0 | 0 | 0 | 8 | |
| 1:15 PM | 2 | 0 | 0 | 0 | 0 | 0 | 0 | 0 | 0 | 1 | 0 | 0 | 2 | 1 | 0 | 0 | 6 | |
| 1:30 PM | 0 | 0 | 0 | 0 | 0 | 0 | 0 | 0 | 0 | 0 | 3 | 0 | 0 | 0 | 0 | 0 | 3 | |
| 1:45 PM | 4 | 0 | 0 | 0 | 0 | 0 | 0 | 0 | 0 | 1 | 3 | 0 | 0 | 0 | 0 | 0 | 8 | |
| TOTAL VOLUMES: | NL | NT | NR | NU | SL | ST | SR | SU | EL | ET | ER | EU | WL | WT | WR | WU | TOTAL | |
| APPROACH %'s: | 93.62% | 0.00% | 4.26% | 2.13% | 0 | 0 | 0 | 0 | 0.00% | 23.26% | 76.74% | 0.00% | 40.00% | 60.00% | 0.00% | 0.00% | 105 | |
| PEAK HR: | 11:15 AM - 12:15 PM | | | | | | | | | | | | | | | | TOTAL | |
| PEAK HR VOL: | 19 | 0 | 0 | 0 | 0 | 0 | 0 | 0 | 0 | 3 | 9 | 0 | 0 | 2 | 0 | 0 | 33 | |
| PEAK HR FACTOR: | 0.528 | 0.000 | 0.000 | 0.000 | 0.000 | 0.000 | 0.000 | 0.000 | 0.000 | 0.375 | 0.563 | 0.000 | 0.000 | 0.500 | 0.000 | 0.000 | 0.589 | |
| | 0.528 | | | | | | | | 0.600 | | | | 0.500 | | | | | |
| PM | NORTHBOUND | | | | SOUTHBOUND | | | | EASTBOUND | | | | WESTBOUND | | | | | |
| | NL | NT | NR | NU | SL | ST | SR | SU | EL | ET | ER | EU | WL | WT | WR | WU | TOTAL | |
| | 2:00 PM | 2 | 0 | 1 | 0 | 0 | 0 | 0 | 0 | 0 | 0 | 6 | 0 | 0 | 0 | 0 | 0 | 9 |
| | 2:15 PM | 5 | 0 | 0 | 0 | 0 | 0 | 0 | 0 | 0 | 0 | 1 | 0 | 0 | 2 | 0 | 0 | 8 |
| | 2:30 PM | 0 | 0 | 2 | 0 | 0 | 0 | 0 | 0 | 0 | 2 | 1 | 0 | 1 | 0 | 0 | 0 | 6 |
| | 2:45 PM | 2 | 0 | 1 | 0 | 0 | 0 | 0 | 0 | 0 | 2 | 3 | 0 | 3 | 1 | 0 | 0 | 12 |
| | 3:00 PM | 1 | 0 | 0 | 0 | 0 | 0 | 0 | 0 | 0 | 2 | 1 | 0 | 0 | 0 | 0 | 0 | 4 |
| | 3:15 PM | 2 | 0 | 0 | 0 | 0 | 0 | 0 | 0 | 0 | 0 | 2 | 0 | 0 | 0 | 0 | 0 | 4 |
| | 3:30 PM | 3 | 0 | 1 | 0 | 0 | 0 | 0 | 0 | 0 | 1 | 3 | 0 | 2 | 1 | 0 | 0 | 11 |
| | 3:45 PM | 2 | 0 | 0 | 0 | 0 | 0 | 0 | 0 | 0 | 2 | 5 | 0 | 1 | 1 | 0 | 0 | 11 |
| 4:00 PM | 1 | 0 | 0 | 0 | 0 | 0 | 0 | 0 | 0 | 1 | 4 | 0 | 2 | 0 | 0 | 0 | 8 | |
| 4:15 PM | 5 | 0 | 0 | 0 | 0 | 0 | 0 | 0 | 0 | 3 | 2 | 0 | 1 | 3 | 0 | 0 | 14 | |
| 4:30 PM | 2 | 0 | 3 | 0 | 0 | 0 | 0 | 0 | 0 | 8 | 1 | 0 | 0 | 0 | 0 | 0 | 14 | |
| 4:45 PM | 0 | 0 | 1 | 0 | 0 | 0 | 0 | 0 | 0 | 4 | 4 | 0 | 1 | 3 | 0 | 0 | 13 | |
| 5:00 PM | 4 | 0 | 0 | 0 | 0 | 0 | 0 | 0 | 0 | 1 | 3 | 0 | 0 | 2 | 0 | 0 | 10 | |
| 5:15 PM | 4 | 0 | 1 | 0 | 0 | 0 | 0 | 0 | 0 | 2 | 6 | 0 | 1 | 1 | 0 | 0 | 15 | |
| 5:30 PM | 2 | 0 | 0 | 0 | 0 | 0 | 0 | 0 | 0 | 3 | 2 | 0 | 0 | 0 | 0 | 0 | 7 | |
| 5:45 PM | 1 | 0 | 1 | 0 | 0 | 0 | 0 | 0 | 0 | 1 | 8 | 0 | 1 | 2 | 0 | 0 | 14 | |
| 6:00 PM | 3 | 0 | 0 | 0 | 0 | 0 | 0 | 0 | 0 | 1 | 3 | 0 | 2 | 0 | 0 | 0 | 9 | |
| 6:15 PM | 2 | 0 | 0 | 0 | 0 | 0 | 0 | 0 | 0 | 0 | 4 | 0 | 0 | 0 | 0 | 0 | 6 | |
| 6:30 PM | 0 | 0 | 1 | 0 | 0 | 0 | 0 | 0 | 0 | 1 | 5 | 0 | 0 | 1 | 0 | 0 | 8 | |
| 6:45 PM | 1 | 0 | 0 | 0 | 0 | 0 | 0 | 0 | 0 | 0 | 6 | 0 | 1 | 1 | 0 | 0 | 9 | |
| TOTAL VOLUMES: | NL | NT | NR | NU | SL | ST | SR | SU | EL | ET | ER | EU | WL | WT | WR | WU | TOTAL | |
| APPROACH %'s: | 77.78% | 0.00% | 22.22% | 0.00% | 0 | 0 | 0 | 0 | 0.00% | 32.69% | 67.31% | 0.00% | 47.06% | 52.94% | 0.00% | 0.00% | 192 | |
| PEAK HR: | 04:30 PM - 05:30 PM | | | | | | | | | | | | | | | | TOTAL | |
| PEAK HR VOL: | 10 | 0 | 5 | 0 | 0 | 0 | 0 | 0 | 0 | 15 | 14 | 0 | 2 | 6 | 0 | 0 | 52 | |
| PEAK HR FACTOR: | 0.625 | 0.000 | 0.417 | 0.000 | 0.000 | 0.000 | 0.000 | 0.000 | 0.000 | 0.469 | 0.583 | 0.000 | 0.500 | 0.500 | 0.000 | 0.000 | 0.867 | |
| | 0.750 | | | | | | | | 0.806 | | | | 0.500 | | | | | |

National Data & Surveying Services Intersection Turning Movement Count

Location: Cagle Mill Rd & Cagle Rd
 City: Lula
 Control: 1-Way Stop (NB)

Project ID: 22-180056-002
 Date: 3/30/2022

Data - Cars

| NS/EW Streets: | Cagle Mill Rd | | | | Cagle Mill Rd | | | | Cagle Rd | | | | Cagle Rd | | | | |
|-----------------|---------------------|-------|--------|-------|---------------|-------|-------|-------|-----------|--------|--------|-------|-----------|--------|-------|-------|-------|
| AM | NORTHBOUND | | | | SOUTHBOUND | | | | EASTBOUND | | | | WESTBOUND | | | | |
| | NL | NT | NR | NU | SL | ST | SR | SU | EL | ET | ER | EU | WL | WT | WR | WU | TOTAL |
| 7:00 AM | 0 | 0 | 0 | 0 | 0 | 0 | 0 | 0 | 0 | 1 | 1 | 0 | 0 | 0 | 0 | 0 | 2 |
| 7:15 AM | 7 | 0 | 0 | 0 | 0 | 0 | 0 | 0 | 0 | 0 | 0 | 0 | 0 | 0 | 0 | 0 | 7 |
| 7:30 AM | 5 | 0 | 1 | 0 | 0 | 0 | 0 | 0 | 0 | 0 | 0 | 0 | 2 | 0 | 0 | 8 | |
| 7:45 AM | 3 | 0 | 0 | 0 | 0 | 0 | 0 | 0 | 0 | 0 | 0 | 2 | 1 | 0 | 0 | 6 | |
| 8:00 AM | 3 | 0 | 0 | 0 | 0 | 0 | 0 | 0 | 0 | 0 | 0 | 0 | 3 | 0 | 0 | 6 | |
| 8:15 AM | 3 | 0 | 0 | 0 | 0 | 0 | 0 | 0 | 0 | 1 | 3 | 0 | 0 | 0 | 0 | 7 | |
| 8:30 AM | 4 | 0 | 1 | 0 | 0 | 0 | 0 | 0 | 0 | 2 | 3 | 0 | 0 | 3 | 0 | 13 | |
| 8:45 AM | 3 | 0 | 0 | 0 | 0 | 0 | 0 | 0 | 0 | 0 | 0 | 0 | 0 | 0 | 0 | 3 | |
| 9:00 AM | 1 | 0 | 0 | 0 | 0 | 0 | 0 | 0 | 0 | 1 | 2 | 0 | 0 | 0 | 0 | 4 | |
| 9:15 AM | 0 | 0 | 1 | 0 | 0 | 0 | 0 | 0 | 0 | 1 | 1 | 0 | 0 | 4 | 0 | 7 | |
| 9:30 AM | 3 | 0 | 1 | 0 | 0 | 0 | 0 | 0 | 0 | 0 | 4 | 0 | 0 | 0 | 0 | 8 | |
| 9:45 AM | 1 | 0 | 0 | 0 | 0 | 0 | 0 | 0 | 0 | 0 | 0 | 1 | 1 | 0 | 0 | 3 | |
| TOTAL VOLUMES: | NL | NT | NR | NU | SL | ST | SR | SU | EL | ET | ER | EU | WL | WT | WR | WU | TOTAL |
| APPROACH %'s: | 33 | 0 | 4 | 0 | 0 | 0 | 0 | 0 | 0 | 6 | 14 | 0 | 3 | 14 | 0 | 0 | 74 |
| | 89.19% | 0.00% | 10.81% | 0.00% | 0.00% | 0.00% | 0.00% | 0.00% | 0.00% | 30.00% | 70.00% | 0.00% | 17.65% | 82.35% | 0.00% | 0.00% | |
| PEAK HR: | 07:45 AM - 08:45 AM | | | | | | | | | | | | | | | | TOTAL |
| PEAK HR VOL: | 13 | 0 | 0 | 0 | 0 | 0 | 0 | 0 | 0 | 3 | 6 | 0 | 2 | 7 | 0 | 0 | 32 |
| PEAK HR FACTOR: | 0.813 | 0.000 | 0.250 | 0.000 | 0.000 | 0.000 | 0.000 | 0.000 | 0.000 | 0.375 | 0.500 | 0.000 | 0.250 | 0.583 | 0.000 | 0.000 | 0.615 |
| | | | 0.700 | | | | | | | 0.450 | | | 0.750 | | | | |
| NOON | NORTHBOUND | | | | SOUTHBOUND | | | | EASTBOUND | | | | WESTBOUND | | | | |
| | NL | NT | NR | NU | SL | ST | SR | SU | EL | ET | ER | EU | WL | WT | WR | WU | TOTAL |
| 10:00 AM | 0 | 0 | 0 | 0 | 0 | 0 | 0 | 0 | 0 | 0 | 2 | 0 | 0 | 1 | 0 | 0 | 3 |
| 10:15 AM | 1 | 0 | 0 | 0 | 0 | 0 | 0 | 0 | 0 | 1 | 3 | 0 | 0 | 0 | 0 | 0 | 5 |
| 10:30 AM | 2 | 0 | 0 | 0 | 0 | 0 | 0 | 0 | 0 | 0 | 2 | 0 | 0 | 0 | 0 | 0 | 4 |
| 10:45 AM | 3 | 0 | 0 | 1 | 0 | 0 | 0 | 0 | 0 | 1 | 1 | 0 | 0 | 1 | 0 | 0 | 7 |
| 11:00 AM | 2 | 0 | 0 | 0 | 0 | 0 | 0 | 0 | 0 | 0 | 1 | 0 | 0 | 1 | 0 | 0 | 4 |
| 11:15 AM | 9 | 0 | 0 | 0 | 0 | 0 | 0 | 0 | 0 | 0 | 4 | 0 | 0 | 1 | 0 | 0 | 14 |
| 11:30 AM | 3 | 0 | 0 | 0 | 0 | 0 | 0 | 0 | 0 | 0 | 1 | 0 | 0 | 0 | 0 | 0 | 4 |
| 11:45 AM | 5 | 0 | 0 | 0 | 0 | 0 | 0 | 0 | 0 | 1 | 1 | 0 | 0 | 0 | 0 | 0 | 7 |
| 12:00 PM | 2 | 0 | 0 | 0 | 0 | 0 | 0 | 0 | 0 | 2 | 3 | 0 | 0 | 1 | 0 | 0 | 8 |
| 12:15 PM | 1 | 0 | 0 | 0 | 0 | 0 | 0 | 0 | 0 | 0 | 0 | 0 | 1 | 1 | 0 | 0 | 3 |
| 12:30 PM | 2 | 0 | 0 | 0 | 0 | 0 | 0 | 0 | 0 | 1 | 5 | 0 | 0 | 0 | 0 | 0 | 8 |
| 12:45 PM | 4 | 0 | 0 | 0 | 0 | 0 | 0 | 0 | 0 | 0 | 1 | 0 | 1 | 1 | 0 | 0 | 7 |
| 1:00 PM | 4 | 0 | 0 | 0 | 0 | 0 | 0 | 0 | 0 | 2 | 2 | 0 | 0 | 0 | 0 | 0 | 8 |
| 1:15 PM | 2 | 0 | 0 | 0 | 0 | 0 | 0 | 0 | 0 | 1 | 0 | 0 | 2 | 1 | 0 | 0 | 6 |
| 1:30 PM | 0 | 0 | 0 | 0 | 0 | 0 | 0 | 0 | 0 | 0 | 3 | 0 | 0 | 0 | 0 | 0 | 3 |
| 1:45 PM | 4 | 0 | 0 | 0 | 0 | 0 | 0 | 0 | 0 | 1 | 3 | 0 | 0 | 0 | 0 | 0 | 8 |
| TOTAL VOLUMES: | NL | NT | NR | NU | SL | ST | SR | SU | EL | ET | ER | EU | WL | WT | WR | WU | TOTAL |
| APPROACH %'s: | 44 | 0 | 0 | 1 | 0 | 0 | 0 | 0 | 0 | 10 | 32 | 0 | 4 | 8 | 0 | 0 | 99 |
| | 97.78% | 0.00% | 0.00% | 2.22% | 0.00% | 0.00% | 0.00% | 0.00% | 0.00% | 23.81% | 76.19% | 0.00% | 33.33% | 66.67% | 0.00% | 0.00% | |
| PEAK HR: | 11:15 AM - 12:15 PM | | | | | | | | | | | | | | | | TOTAL |
| PEAK HR VOL: | 19 | 0 | 0 | 0 | 0 | 0 | 0 | 0 | 0 | 3 | 9 | 0 | 0 | 2 | 0 | 0 | 33 |
| PEAK HR FACTOR: | 0.528 | 0.000 | 0.000 | 0.000 | 0.000 | 0.000 | 0.000 | 0.000 | 0.000 | 0.375 | 0.563 | 0.000 | 0.000 | 0.500 | 0.000 | 0.000 | 0.589 |
| | | | 0.528 | | | | | | | 0.600 | | | 0.500 | | | | |
| PM | NORTHBOUND | | | | SOUTHBOUND | | | | EASTBOUND | | | | WESTBOUND | | | | |
| | NL | NT | NR | NU | SL | ST | SR | SU | EL | ET | ER | EU | WL | WT | WR | WU | TOTAL |
| 2:00 PM | 2 | 0 | 1 | 0 | 0 | 0 | 0 | 0 | 0 | 0 | 5 | 0 | 0 | 0 | 0 | 0 | 8 |
| 2:15 PM | 5 | 0 | 0 | 0 | 0 | 0 | 0 | 0 | 0 | 0 | 1 | 0 | 0 | 2 | 0 | 0 | 8 |
| 2:30 PM | 0 | 0 | 2 | 0 | 0 | 0 | 0 | 0 | 0 | 2 | 1 | 0 | 1 | 0 | 0 | 0 | 6 |
| 2:45 PM | 2 | 0 | 1 | 0 | 0 | 0 | 0 | 0 | 0 | 2 | 3 | 0 | 1 | 1 | 0 | 0 | 10 |
| 3:00 PM | 1 | 0 | 0 | 0 | 0 | 0 | 0 | 0 | 0 | 2 | 1 | 0 | 0 | 0 | 0 | 0 | 4 |
| 3:15 PM | 2 | 0 | 0 | 0 | 0 | 0 | 0 | 0 | 0 | 0 | 2 | 0 | 0 | 0 | 0 | 0 | 4 |
| 3:30 PM | 3 | 0 | 1 | 0 | 0 | 0 | 0 | 0 | 0 | 1 | 3 | 0 | 2 | 1 | 0 | 0 | 11 |
| 3:45 PM | 2 | 0 | 0 | 0 | 0 | 0 | 0 | 0 | 0 | 2 | 5 | 0 | 1 | 1 | 0 | 0 | 11 |
| 4:00 PM | 1 | 0 | 0 | 0 | 0 | 0 | 0 | 0 | 0 | 1 | 4 | 0 | 2 | 0 | 0 | 0 | 8 |
| 4:15 PM | 4 | 0 | 0 | 0 | 0 | 0 | 0 | 0 | 0 | 3 | 2 | 0 | 1 | 3 | 0 | 0 | 13 |
| 4:30 PM | 2 | 0 | 3 | 0 | 0 | 0 | 0 | 0 | 0 | 8 | 1 | 0 | 0 | 0 | 0 | 0 | 14 |
| 4:45 PM | 0 | 0 | 1 | 0 | 0 | 0 | 0 | 0 | 0 | 4 | 4 | 0 | 1 | 3 | 0 | 0 | 13 |
| 5:00 PM | 4 | 0 | 0 | 0 | 0 | 0 | 0 | 0 | 0 | 1 | 3 | 0 | 0 | 2 | 0 | 0 | 10 |
| 5:15 PM | 4 | 0 | 1 | 0 | 0 | 0 | 0 | 0 | 0 | 2 | 6 | 0 | 1 | 1 | 0 | 0 | 15 |
| 5:30 PM | 2 | 0 | 0 | 0 | 0 | 0 | 0 | 0 | 0 | 3 | 2 | 0 | 0 | 0 | 0 | 0 | 7 |
| 5:45 PM | 1 | 0 | 1 | 0 | 0 | 0 | 0 | 0 | 0 | 1 | 8 | 0 | 1 | 2 | 0 | 0 | 14 |
| 6:00 PM | 3 | 0 | 0 | 0 | 0 | 0 | 0 | 0 | 0 | 1 | 3 | 0 | 2 | 0 | 0 | 0 | 9 |
| 6:15 PM | 2 | 0 | 0 | 0 | 0 | 0 | 0 | 0 | 0 | 0 | 4 | 0 | 0 | 0 | 0 | 0 | 6 |
| 6:30 PM | 0 | 0 | 1 | 0 | 0 | 0 | 0 | 0 | 0 | 0 | 5 | 0 | 0 | 1 | 0 | 0 | 7 |
| 6:45 PM | 1 | 0 | 0 | 0 | 0 | 0 | 0 | 0 | 0 | 0 | 6 | 0 | 1 | 0 | 0 | 0 | 8 |
| TOTAL VOLUMES: | NL | NT | NR | NU | SL | ST | SR | SU | EL | ET | ER | EU | WL | WT | WR | WU | TOTAL |
| APPROACH %'s: | 41 | 0 | 12 | 0 | 0 | 0 | 0 | 0 | 0 | 33 | 69 | 0 | 14 | 17 | 0 | 0 | 186 |
| | 77.36% | 0.00% | 22.64% | 0.00% | 0.00% | 0.00% | 0.00% | 0.00% | 0.00% | 32.35% | 67.65% | 0.00% | 45.16% | 54.84% | 0.00% | 0.00% | |
| PEAK HR: | 04:30 PM - 05:30 PM | | | | | | | | | | | | | | | | TOTAL |
| PEAK HR VOL: | 10 | 0 | 5 | 0 | 0 | 0 | 0 | 0 | 0 | 15 | 14 | 0 | 2 | 6 | 0 | 0 | 52 |
| PEAK HR FACTOR: | 0.625 | 0.000 | 0.417 | 0.000 | 0.000 | 0.000 | 0.000 | 0.000 | 0.000 | 0.469 | 0.583 | 0.000 | 0.500 | 0.500 | 0.000 | 0.000 | 0.867 |
| | | | 0.750 | | | | | | | 0.806 | | | 0.500 | | | | |

National Data & Surveying Services Intersection Turning Movement Count

Location: Cagle Mill Rd & Cagle Rd
 City: Lula
 Control: 1-Way Stop (NB)

Project ID: 22-180056-002
 Date: 3/30/2022

Data - Bikes

| NS/EW Streets: | Cagle Mill Rd | | | | Cagle Mill Rd | | | | Cagle Rd | | | | Cagle Rd | | | | |
|-----------------------------------|---------------------|-------|-------|-------|---------------|-------|-------|-------|-----------|-------|-------|-------|-----------|-------|-------|-------|-------|
| AM | NORTHBOUND | | | | SOUTHBOUND | | | | EASTBOUND | | | | WESTBOUND | | | | |
| | NL | NT | NR | NU | SL | ST | SR | SU | EL | ET | ER | EU | WL | WT | WR | WU | TOTAL |
| 7:00 AM | 0 | 0 | 0 | 0 | 0 | 0 | 0 | 0 | 0 | 0 | 0 | 0 | 0 | 0 | 0 | 0 | 0 |
| 7:15 AM | 0 | 0 | 0 | 0 | 0 | 0 | 0 | 0 | 0 | 0 | 0 | 0 | 0 | 0 | 0 | 0 | 0 |
| 7:30 AM | 0 | 0 | 0 | 0 | 0 | 0 | 0 | 0 | 0 | 0 | 0 | 0 | 0 | 0 | 0 | 0 | 0 |
| 7:45 AM | 0 | 0 | 0 | 0 | 0 | 0 | 0 | 0 | 0 | 0 | 0 | 0 | 0 | 0 | 0 | 0 | 0 |
| 8:00 AM | 0 | 0 | 0 | 0 | 0 | 0 | 0 | 0 | 0 | 0 | 0 | 0 | 0 | 0 | 0 | 0 | 0 |
| 8:15 AM | 0 | 0 | 0 | 0 | 0 | 0 | 0 | 0 | 0 | 0 | 0 | 0 | 0 | 0 | 0 | 0 | 0 |
| 8:30 AM | 0 | 0 | 0 | 0 | 0 | 0 | 0 | 0 | 0 | 0 | 0 | 0 | 0 | 0 | 0 | 0 | 0 |
| 8:45 AM | 0 | 0 | 0 | 0 | 0 | 0 | 0 | 0 | 0 | 0 | 0 | 0 | 0 | 0 | 0 | 0 | 0 |
| 9:00 AM | 0 | 0 | 0 | 0 | 0 | 0 | 0 | 0 | 0 | 0 | 0 | 0 | 0 | 0 | 0 | 0 | 0 |
| 9:15 AM | 0 | 0 | 0 | 0 | 0 | 0 | 0 | 0 | 0 | 0 | 0 | 0 | 0 | 0 | 0 | 0 | 0 |
| 9:30 AM | 0 | 0 | 0 | 0 | 0 | 0 | 0 | 0 | 0 | 0 | 0 | 0 | 0 | 0 | 0 | 0 | 0 |
| 9:45 AM | 0 | 0 | 0 | 0 | 0 | 0 | 0 | 0 | 0 | 0 | 0 | 0 | 0 | 0 | 0 | 0 | 0 |
| TOTAL VOLUMES : APPROACH %'s : | NL | NT | NR | NU | SL | ST | SR | SU | EL | ET | ER | EU | WL | WT | WR | WU | TOTAL |
| | 0 | 0 | 0 | 0 | 0 | 0 | 0 | 0 | 0 | 0 | 0 | 0 | 0 | 0 | 0 | 0 | 0 |
| PEAK HR : | 07:45 AM - 08:45 AM | | | | | | | | | | | | | | | | |
| PEAK HR VOL : | 0 | 0 | 0 | 0 | 0 | 0 | 0 | 0 | 0 | 0 | 0 | 0 | 0 | 0 | 0 | 0 | 0 |
| PEAK HR FACTOR : | 0.000 | 0.000 | 0.000 | 0.000 | 0.000 | 0.000 | 0.000 | 0.000 | 0.000 | 0.000 | 0.000 | 0.000 | 0.000 | 0.000 | 0.000 | 0.000 | 0 |
| | | | | | | | | | | | | | | | | | |
| NOON | NORTHBOUND | | | | SOUTHBOUND | | | | EASTBOUND | | | | WESTBOUND | | | | |
| | NL | NT | NR | NU | SL | ST | SR | SU | EL | ET | ER | EU | WL | WT | WR | WU | TOTAL |
| 10:00 AM | 0 | 0 | 0 | 0 | 0 | 0 | 0 | 0 | 0 | 0 | 0 | 0 | 0 | 0 | 0 | 0 | 0 |
| 10:15 AM | 0 | 0 | 0 | 0 | 0 | 0 | 0 | 0 | 0 | 0 | 0 | 0 | 0 | 0 | 0 | 0 | 0 |
| 10:30 AM | 0 | 0 | 0 | 0 | 0 | 0 | 0 | 0 | 0 | 0 | 0 | 0 | 0 | 0 | 0 | 0 | 0 |
| 10:45 AM | 0 | 0 | 0 | 0 | 0 | 0 | 0 | 0 | 0 | 0 | 0 | 0 | 0 | 0 | 0 | 0 | 0 |
| 11:00 AM | 0 | 0 | 0 | 0 | 0 | 0 | 0 | 0 | 0 | 0 | 0 | 0 | 0 | 0 | 0 | 0 | 0 |
| 11:15 AM | 0 | 0 | 0 | 0 | 0 | 0 | 0 | 0 | 0 | 0 | 0 | 0 | 0 | 0 | 0 | 0 | 0 |
| 11:30 AM | 0 | 0 | 0 | 0 | 0 | 0 | 0 | 0 | 0 | 0 | 0 | 0 | 0 | 0 | 0 | 0 | 0 |
| 11:45 AM | 0 | 0 | 0 | 0 | 0 | 0 | 0 | 0 | 0 | 0 | 0 | 0 | 0 | 0 | 0 | 0 | 0 |
| 12:00 PM | 0 | 0 | 0 | 0 | 0 | 0 | 0 | 0 | 0 | 0 | 0 | 0 | 0 | 0 | 0 | 0 | 0 |
| 12:15 PM | 0 | 0 | 0 | 0 | 0 | 0 | 0 | 0 | 0 | 0 | 0 | 0 | 0 | 0 | 0 | 0 | 0 |
| 12:30 PM | 0 | 0 | 0 | 0 | 0 | 0 | 0 | 0 | 0 | 0 | 0 | 0 | 0 | 0 | 0 | 0 | 0 |
| 12:45 PM | 0 | 0 | 0 | 0 | 0 | 0 | 0 | 0 | 0 | 1 | 0 | 0 | 0 | 0 | 0 | 0 | 1 |
| 1:00 PM | 0 | 0 | 0 | 0 | 0 | 0 | 0 | 0 | 0 | 0 | 0 | 0 | 0 | 0 | 0 | 0 | 0 |
| 1:15 PM | 0 | 0 | 0 | 0 | 0 | 0 | 0 | 0 | 0 | 0 | 0 | 0 | 0 | 0 | 0 | 0 | 0 |
| 1:30 PM | 0 | 0 | 0 | 0 | 0 | 0 | 0 | 0 | 0 | 0 | 0 | 0 | 0 | 0 | 0 | 0 | 0 |
| 1:45 PM | 0 | 0 | 0 | 0 | 0 | 0 | 0 | 0 | 0 | 0 | 0 | 0 | 0 | 0 | 0 | 0 | 0 |
| TOTAL VOLUMES : APPROACH %'s : | NL | NT | NR | NU | SL | ST | SR | SU | EL | ET | ER | EU | WL | WT | WR | WU | TOTAL |
| | 0 | 0 | 0 | 0 | 0 | 0 | 0 | 0 | 0 | 1 | 0 | 0 | 0 | 0 | 0 | 0 | 1 |
| PEAK HR : | 11:15 AM - 12:15 PM | | | | | | | | | | | | | | | | |
| PEAK HR VOL : | 0 | 0 | 0 | 0 | 0 | 0 | 0 | 0 | 0 | 0 | 0 | 0 | 0 | 0 | 0 | 0 | 0 |
| PEAK HR FACTOR : | 0.000 | 0.000 | 0.000 | 0.000 | 0.000 | 0.000 | 0.000 | 0.000 | 0.000 | 0.000 | 0.000 | 0.000 | 0.000 | 0.000 | 0.000 | 0.000 | 0 |
| | | | | | | | | | | | | | | | | | |
| PM | NORTHBOUND | | | | SOUTHBOUND | | | | EASTBOUND | | | | WESTBOUND | | | | |
| | NL | NT | NR | NU | SL | ST | SR | SU | EL | ET | ER | EU | WL | WT | WR | WU | TOTAL |
| 2:00 PM | 0 | 0 | 0 | 0 | 0 | 0 | 0 | 0 | 0 | 0 | 0 | 0 | 0 | 0 | 0 | 0 | 0 |
| 2:15 PM | 0 | 0 | 0 | 0 | 0 | 0 | 0 | 0 | 0 | 0 | 0 | 0 | 0 | 0 | 0 | 0 | 0 |
| 2:30 PM | 0 | 0 | 0 | 0 | 0 | 0 | 0 | 0 | 0 | 0 | 0 | 0 | 0 | 0 | 0 | 0 | 0 |
| 2:45 PM | 0 | 0 | 0 | 0 | 0 | 0 | 0 | 0 | 0 | 0 | 0 | 0 | 0 | 0 | 0 | 0 | 0 |
| 3:00 PM | 0 | 0 | 0 | 0 | 0 | 0 | 0 | 0 | 0 | 0 | 0 | 0 | 0 | 0 | 0 | 0 | 0 |
| 3:15 PM | 0 | 0 | 0 | 0 | 0 | 0 | 0 | 0 | 0 | 0 | 0 | 0 | 0 | 0 | 0 | 0 | 0 |
| 3:30 PM | 0 | 0 | 0 | 0 | 0 | 0 | 0 | 0 | 0 | 0 | 0 | 0 | 0 | 0 | 0 | 0 | 0 |
| 3:45 PM | 0 | 0 | 0 | 0 | 0 | 0 | 0 | 0 | 0 | 0 | 0 | 0 | 0 | 0 | 0 | 0 | 0 |
| 4:00 PM | 0 | 0 | 0 | 0 | 0 | 0 | 0 | 0 | 0 | 0 | 0 | 0 | 0 | 0 | 0 | 0 | 0 |
| 4:15 PM | 0 | 0 | 0 | 0 | 0 | 0 | 0 | 0 | 0 | 0 | 0 | 0 | 0 | 0 | 0 | 0 | 0 |
| 4:30 PM | 0 | 0 | 0 | 0 | 0 | 0 | 0 | 0 | 0 | 0 | 0 | 0 | 0 | 0 | 0 | 0 | 0 |
| 4:45 PM | 0 | 0 | 0 | 0 | 0 | 0 | 0 | 0 | 0 | 0 | 0 | 0 | 0 | 0 | 0 | 0 | 0 |
| 5:00 PM | 0 | 0 | 0 | 0 | 0 | 0 | 0 | 0 | 0 | 0 | 0 | 0 | 0 | 0 | 0 | 0 | 0 |
| 5:15 PM | 0 | 0 | 0 | 0 | 0 | 0 | 0 | 0 | 0 | 0 | 0 | 0 | 0 | 0 | 0 | 0 | 0 |
| 5:30 PM | 0 | 0 | 0 | 0 | 0 | 0 | 0 | 0 | 0 | 0 | 0 | 0 | 0 | 0 | 0 | 0 | 0 |
| 5:45 PM | 0 | 0 | 0 | 0 | 0 | 0 | 0 | 0 | 0 | 0 | 0 | 0 | 0 | 0 | 0 | 0 | 0 |
| 6:00 PM | 0 | 0 | 0 | 0 | 0 | 0 | 0 | 0 | 0 | 0 | 0 | 0 | 0 | 0 | 0 | 0 | 0 |
| 6:15 PM | 0 | 0 | 0 | 0 | 0 | 0 | 0 | 0 | 0 | 0 | 0 | 0 | 0 | 0 | 0 | 0 | 0 |
| 6:30 PM | 0 | 0 | 0 | 0 | 0 | 0 | 0 | 0 | 0 | 0 | 0 | 0 | 0 | 0 | 0 | 0 | 0 |
| 6:45 PM | 0 | 0 | 0 | 0 | 0 | 0 | 0 | 0 | 0 | 0 | 0 | 0 | 0 | 0 | 0 | 0 | 0 |
| TOTAL VOLUMES : APPROACH %'s : | NL | NT | NR | NU | SL | ST | SR | SU | EL | ET | ER | EU | WL | WT | WR | WU | TOTAL |
| | 0 | 0 | 0 | 0 | 0 | 0 | 0 | 0 | 0 | 0 | 0 | 0 | 0 | 0 | 0 | 0 | 0 |
| PEAK HR : | 04:30 PM - 05:30 PM | | | | | | | | | | | | | | | | |
| PEAK HR VOL : | 0 | 0 | 0 | 0 | 0 | 0 | 0 | 0 | 0 | 0 | 0 | 0 | 0 | 0 | 0 | 0 | 0 |
| PEAK HR FACTOR : | 0.000 | 0.000 | 0.000 | 0.000 | 0.000 | 0.000 | 0.000 | 0.000 | 0.000 | 0.000 | 0.000 | 0.000 | 0.000 | 0.000 | 0.000 | 0.000 | 0 |

Cagle Mill Rd & Cagle Rd

Peak Hour Turning Movement Count

ID: 22-180056-002
City: Lula

Day: Wednesday
Date: 3/30/2022

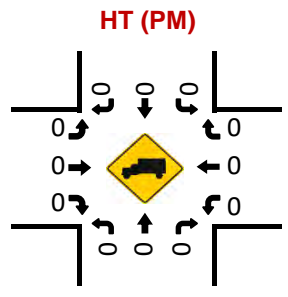
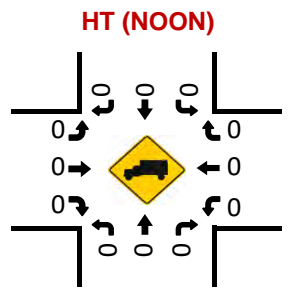
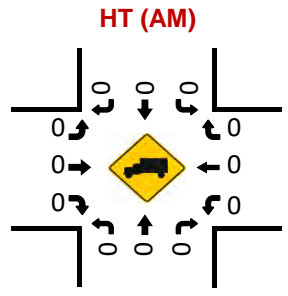
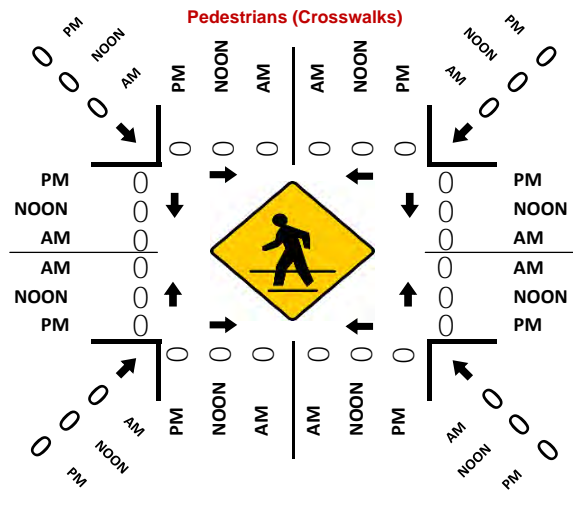
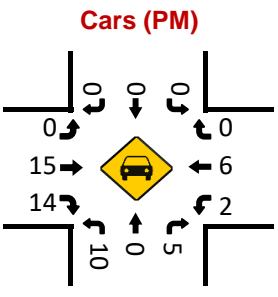
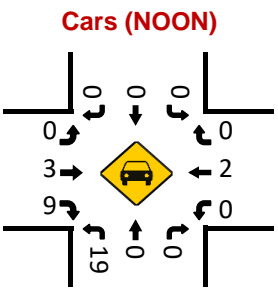
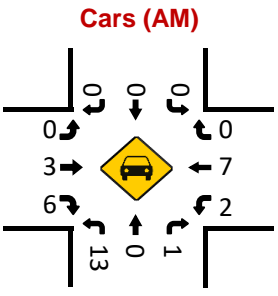
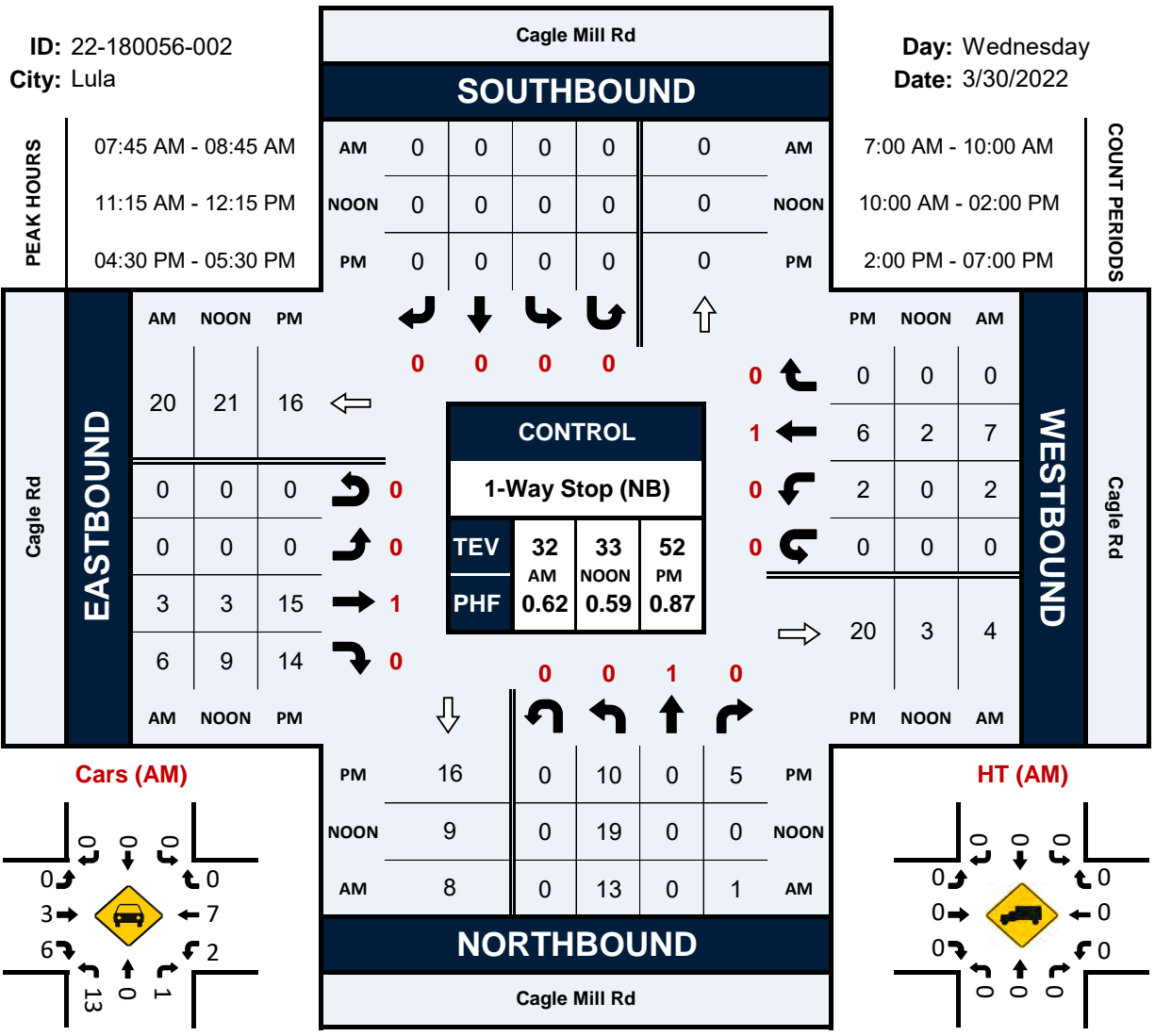

Project ID: 22-180056-002
 Location: Cagle Mill Rd & Cagle Rd
 City: Lula

Day: Wednesday
 Date: 3/30/2022

Groups Printed - Cars, PU, Vans - Heavy Trucks

| Start Time | Cagle Mill Rd Northbound | | | | | | Cagle Mill Rd Southbound | | | | | | Cagle Rd Eastbound | | | | | | Cagle Rd Westbound | | | | | | Int. Total |
|------------------|--------------------------|------|------|-------|------|------------|--------------------------|------|-----|------|------|------------|--------------------|------|------|------|------|------------|--------------------|------|-----|------|------|------------|------------|
| | Left | Thru | Rgt | Utum | Peds | App. Total | Left | Thru | Rgt | Utum | Peds | App. Total | Left | Thru | Rgt | Utum | Peds | App. Total | Left | Thru | Rgt | Utum | Peds | App. Total | |
| 7:00 AM | 1 | 0 | 0 | 0 | 0 | 1 | 0 | 0 | 0 | 0 | 0 | 0 | 0 | 1 | 1 | 0 | 0 | 0 | 2 | 0 | 0 | 0 | 0 | 0 | 0 |
| 7:15 AM | 7 | 0 | 0 | 0 | 0 | 7 | 0 | 0 | 0 | 0 | 0 | 0 | 0 | 0 | 0 | 0 | 0 | 0 | 0 | 0 | 0 | 0 | 0 | 0 | 0 |
| 7:30 AM | 5 | 0 | 1 | 0 | 0 | 6 | 0 | 0 | 0 | 0 | 0 | 0 | 0 | 1 | 1 | 0 | 0 | 0 | 2 | 0 | 2 | 0 | 0 | 0 | 2 |
| 7:45 AM | 3 | 0 | 0 | 0 | 0 | 3 | 0 | 0 | 0 | 0 | 0 | 0 | 0 | 0 | 0 | 0 | 0 | 0 | 0 | 2 | 1 | 0 | 0 | 0 | 3 |
| Total | 16 | 0 | 1 | 0 | 0 | 17 | 0 | 0 | 0 | 0 | 0 | 0 | 0 | 2 | 2 | 0 | 0 | 0 | 4 | 2 | 3 | 0 | 0 | 0 | 5 |
| 8:00 AM | 3 | 0 | 0 | 0 | 0 | 3 | 0 | 0 | 0 | 0 | 0 | 0 | 0 | 0 | 0 | 0 | 0 | 0 | 0 | 0 | 3 | 0 | 0 | 0 | 3 |
| 8:15 AM | 3 | 0 | 0 | 0 | 0 | 3 | 0 | 0 | 0 | 0 | 0 | 0 | 0 | 0 | 1 | 3 | 0 | 0 | 4 | 0 | 0 | 0 | 0 | 0 | 0 |
| 8:30 AM | 4 | 0 | 1 | 0 | 0 | 5 | 0 | 0 | 0 | 0 | 0 | 0 | 0 | 2 | 3 | 0 | 0 | 0 | 5 | 0 | 3 | 0 | 0 | 0 | 3 |
| 8:45 AM | 3 | 0 | 0 | 0 | 0 | 3 | 0 | 0 | 0 | 0 | 0 | 0 | 0 | 0 | 0 | 0 | 0 | 0 | 0 | 0 | 0 | 0 | 0 | 0 | 0 |
| Total | 13 | 0 | 1 | 0 | 0 | 14 | 0 | 0 | 0 | 0 | 0 | 0 | 0 | 3 | 6 | 0 | 0 | 0 | 9 | 0 | 6 | 0 | 0 | 0 | 6 |
| 9:00 AM | 1 | 0 | 0 | 0 | 0 | 1 | 0 | 0 | 0 | 0 | 0 | 0 | 0 | 1 | 2 | 0 | 0 | 3 | 0 | 0 | 0 | 0 | 0 | 0 | 4 |
| 9:15 AM | 0 | 0 | 1 | 0 | 0 | 1 | 0 | 0 | 0 | 0 | 0 | 0 | 0 | 1 | 1 | 0 | 0 | 2 | 0 | 4 | 0 | 0 | 0 | 0 | 4 |
| 9:30 AM | 3 | 0 | 1 | 0 | 0 | 4 | 0 | 0 | 0 | 0 | 0 | 0 | 0 | 0 | 4 | 0 | 0 | 4 | 0 | 0 | 0 | 0 | 0 | 0 | 8 |
| 9:45 AM | 1 | 0 | 0 | 0 | 0 | 1 | 0 | 0 | 0 | 0 | 0 | 0 | 0 | 0 | 0 | 0 | 0 | 0 | 1 | 1 | 0 | 0 | 0 | 0 | 2 |
| Total | 5 | 0 | 2 | 0 | 0 | 7 | 0 | 0 | 0 | 0 | 0 | 0 | 0 | 2 | 7 | 0 | 0 | 9 | 1 | 5 | 0 | 0 | 0 | 0 | 6 |
| ***BREAK*** | | | | | | | | | | | | | | | | | | | | | | | | | |
| 10:00 AM | 0 | 0 | 0 | 0 | 0 | 0 | 0 | 0 | 0 | 0 | 0 | 0 | 0 | 0 | 2 | 0 | 0 | 2 | 0 | 2 | 0 | 0 | 0 | 0 | 2 |
| 10:15 AM | 1 | 0 | 0 | 0 | 0 | 1 | 0 | 0 | 0 | 0 | 0 | 0 | 0 | 1 | 3 | 0 | 0 | 4 | 0 | 0 | 0 | 0 | 0 | 0 | 0 |
| 10:30 AM | 2 | 0 | 0 | 0 | 0 | 2 | 0 | 0 | 0 | 0 | 0 | 0 | 0 | 0 | 2 | 0 | 0 | 2 | 0 | 0 | 0 | 0 | 0 | 0 | 4 |
| 10:45 AM | 3 | 0 | 2 | 1 | 0 | 6 | 0 | 0 | 0 | 0 | 0 | 0 | 0 | 1 | 1 | 0 | 0 | 2 | 1 | 1 | 0 | 0 | 0 | 0 | 2 |
| Total | 6 | 0 | 2 | 1 | 0 | 9 | 0 | 0 | 0 | 0 | 0 | 0 | 0 | 2 | 8 | 0 | 0 | 10 | 1 | 3 | 0 | 0 | 0 | 0 | 4 |
| 11:00 AM | 2 | 0 | 0 | 0 | 0 | 2 | 0 | 0 | 0 | 0 | 0 | 0 | 0 | 0 | 1 | 0 | 0 | 1 | 1 | 1 | 0 | 0 | 0 | 0 | 2 |
| 11:15 AM | 9 | 0 | 0 | 0 | 0 | 9 | 0 | 0 | 0 | 0 | 0 | 0 | 0 | 0 | 4 | 0 | 0 | 4 | 0 | 1 | 0 | 0 | 0 | 0 | 1 |
| 11:30 AM | 3 | 0 | 0 | 0 | 0 | 3 | 0 | 0 | 0 | 0 | 0 | 0 | 0 | 0 | 1 | 0 | 0 | 1 | 0 | 0 | 0 | 0 | 0 | 0 | 4 |
| 11:45 AM | 5 | 0 | 0 | 0 | 0 | 5 | 0 | 0 | 0 | 0 | 0 | 0 | 0 | 1 | 1 | 0 | 0 | 2 | 0 | 0 | 0 | 0 | 0 | 0 | 7 |
| Total | 19 | 0 | 0 | 0 | 0 | 19 | 0 | 0 | 0 | 0 | 0 | 0 | 0 | 1 | 7 | 0 | 0 | 8 | 1 | 2 | 0 | 0 | 0 | 0 | 3 |
| 12:00 PM | 2 | 0 | 0 | 0 | 0 | 2 | 0 | 0 | 0 | 0 | 0 | 0 | 0 | 2 | 3 | 0 | 0 | 5 | 0 | 1 | 0 | 0 | 0 | 0 | 1 |
| 12:15 PM | 1 | 0 | 0 | 0 | 0 | 1 | 0 | 0 | 0 | 0 | 0 | 0 | 0 | 0 | 0 | 0 | 0 | 0 | 1 | 1 | 0 | 0 | 0 | 0 | 2 |
| 12:30 PM | 2 | 0 | 0 | 0 | 0 | 2 | 0 | 0 | 0 | 0 | 0 | 0 | 0 | 1 | 6 | 0 | 0 | 7 | 0 | 0 | 0 | 0 | 0 | 0 | 9 |
| 12:45 PM | 4 | 0 | 0 | 0 | 0 | 4 | 0 | 0 | 0 | 0 | 0 | 0 | 0 | 0 | 1 | 1 | 0 | 0 | 1 | 1 | 1 | 0 | 0 | 0 | 2 |
| Total | 9 | 0 | 0 | 0 | 0 | 9 | 0 | 0 | 0 | 0 | 0 | 0 | 0 | 3 | 10 | 0 | 0 | 13 | 2 | 3 | 0 | 0 | 0 | 0 | 5 |
| 1:00 PM | 4 | 0 | 0 | 0 | 0 | 4 | 0 | 0 | 0 | 0 | 0 | 0 | 0 | 2 | 2 | 0 | 0 | 4 | 0 | 0 | 0 | 0 | 0 | 0 | 8 |
| 1:15 PM | 2 | 0 | 0 | 0 | 0 | 2 | 0 | 0 | 0 | 0 | 0 | 0 | 0 | 1 | 0 | 0 | 0 | 1 | 2 | 1 | 0 | 0 | 0 | 0 | 3 |
| 1:30 PM | 0 | 0 | 0 | 0 | 0 | 0 | 0 | 0 | 0 | 0 | 0 | 0 | 0 | 0 | 3 | 0 | 0 | 3 | 0 | 0 | 0 | 0 | 0 | 0 | 3 |
| 1:45 PM | 4 | 0 | 0 | 0 | 0 | 4 | 0 | 0 | 0 | 0 | 0 | 0 | 0 | 1 | 3 | 0 | 0 | 4 | 0 | 0 | 0 | 0 | 0 | 0 | 8 |
| Total | 10 | 0 | 0 | 0 | 0 | 10 | 0 | 0 | 0 | 0 | 0 | 0 | 0 | 4 | 8 | 0 | 0 | 12 | 2 | 1 | 0 | 0 | 0 | 0 | 3 |
| ***BREAK*** | | | | | | | | | | | | | | | | | | | | | | | | | |
| 2:00 PM | 2 | 0 | 1 | 0 | 0 | 3 | 0 | 0 | 0 | 0 | 0 | 0 | 0 | 0 | 6 | 0 | 0 | 6 | 0 | 0 | 0 | 0 | 0 | 0 | 9 |
| 2:15 PM | 5 | 0 | 0 | 0 | 0 | 5 | 0 | 0 | 0 | 0 | 0 | 0 | 0 | 0 | 1 | 0 | 0 | 1 | 0 | 2 | 0 | 0 | 0 | 0 | 2 |
| 2:30 PM | 0 | 0 | 2 | 0 | 0 | 2 | 0 | 0 | 0 | 0 | 0 | 0 | 0 | 2 | 1 | 0 | 0 | 3 | 1 | 0 | 0 | 0 | 0 | 0 | 1 |
| 2:45 PM | 2 | 0 | 1 | 0 | 0 | 3 | 0 | 0 | 0 | 0 | 0 | 0 | 0 | 2 | 3 | 0 | 0 | 5 | 3 | 1 | 0 | 0 | 0 | 0 | 4 |
| Total | 9 | 0 | 4 | 0 | 0 | 13 | 0 | 0 | 0 | 0 | 0 | 0 | 0 | 4 | 11 | 0 | 0 | 15 | 4 | 3 | 0 | 0 | 0 | 0 | 7 |
| 3:00 PM | 1 | 0 | 0 | 0 | 0 | 1 | 0 | 0 | 0 | 0 | 0 | 0 | 0 | 2 | 1 | 0 | 0 | 3 | 0 | 0 | 0 | 0 | 0 | 0 | 4 |
| 3:15 PM | 2 | 0 | 0 | 0 | 0 | 2 | 0 | 0 | 0 | 0 | 0 | 0 | 0 | 0 | 2 | 0 | 0 | 2 | 0 | 0 | 0 | 0 | 0 | 0 | 4 |
| 3:30 PM | 3 | 0 | 1 | 0 | 0 | 4 | 0 | 0 | 0 | 0 | 0 | 0 | 0 | 1 | 3 | 0 | 0 | 4 | 2 | 1 | 0 | 0 | 0 | 0 | 3 |
| 3:45 PM | 2 | 0 | 0 | 0 | 0 | 2 | 0 | 0 | 0 | 0 | 0 | 0 | 0 | 2 | 5 | 0 | 0 | 7 | 1 | 1 | 0 | 0 | 0 | 0 | 2 |
| Total | 8 | 0 | 1 | 0 | 0 | 9 | 0 | 0 | 0 | 0 | 0 | 0 | 0 | 5 | 11 | 0 | 0 | 16 | 3 | 2 | 0 | 0 | 0 | 0 | 5 |
| 4:00 PM | 1 | 0 | 0 | 0 | 0 | 1 | 0 | 0 | 0 | 0 | 0 | 0 | 0 | 1 | 4 | 0 | 0 | 5 | 2 | 0 | 0 | 0 | 0 | 0 | 2 |
| 4:15 PM | 5 | 0 | 0 | 0 | 0 | 5 | 0 | 0 | 0 | 0 | 0 | 0 | 0 | 3 | 2 | 0 | 0 | 5 | 1 | 3 | 0 | 0 | 0 | 0 | 4 |
| 4:30 PM | 2 | 0 | 3 | 0 | 0 | 5 | 0 | 0 | 0 | 0 | 0 | 0 | 0 | 8 | 1 | 0 | 0 | 9 | 0 | 0 | 0 | 0 | 0 | 0 | 14 |
| 4:45 PM | 0 | 0 | 1 | 0 | 0 | 1 | 0 | 0 | 0 | 0 | 0 | 0 | 0 | 4 | 4 | 0 | 0 | 8 | 1 | 3 | 0 | 0 | 0 | 0 | 4 |
| Total | 8 | 0 | 4 | 0 | 0 | 12 | 0 | 0 | 0 | 0 | 0 | 0 | 0 | 16 | 11 | 0 | 0 | 27 | 4 | 6 | 0 | 0 | 0 | 0 | 10 |
| 5:00 PM | 4 | 0 | 0 | 0 | 0 | 4 | 0 | 0 | 0 | 0 | 0 | 0 | 0 | 1 | 3 | 0 | 0 | 4 | 0 | 2 | 0 | 0 | 0 | 0 | 2 |
| 5:15 PM | 4 | 0 | 1 | 0 | 0 | 5 | 0 | 0 | 0 | 0 | 0 | 0 | 0 | 2 | 6 | 0 | 0 | 8 | 1 | 1 | 0 | 0 | 0 | 0 | 2 |
| 5:30 PM | 2 | 0 | 0 | 0 | 0 | 2 | 0 | 0 | 0 | 0 | 0 | 0 | 0 | 3 | 2 | 0 | 0 | 5 | 0 | 0 | 0 | 0 | 0 | 0 | 7 |
| 5:45 PM | 1 | 0 | 1 | 0 | 0 | 2 | 0 | 0 | 0 | 0 | 0 | 0 | 0 | 1 | 8 | 0 | 0 | 9 | 1 | 2 | 0 | 0 | 0 | 0 | 3 |
| Total | 11 | 0 | 2 | 0 | 0 | 13 | 0 | 0 | 0 | 0 | 0 | 0 | 0 | 7 | 19 | 0 | 0 | 26 | 2 | 5 | 0 | 0 | 0 | 0 | 7 |
| 6:00 PM | 3 | 0 | 0 | 0 | 0 | 3 | 0 | 0 | 0 | 0 | 0 | 0 | 0 | 1 | 3 | 0 | 0 | 4 | 2 | 0 | 0 | 0 | 0 | 0 | 2 |
| 6:15 PM | 2 | 0 | 0 | 0 | 0 | 2 | 0 | 0 | 0 | 0 | 0 | 0 | 0 | 0 | 4 | 0 | 0 | 4 | 0 | 0 | 0 | 0 | 0 | 0 | 6 |
| 6:30 PM | 0 | 0 | 1 | 0 | 0 | 1 | 0 | 0 | 0 | 0 | 0 | 0 | 0 | 1 | 5 | 0 | 0 | 6 | 0 | 1 | 0 | 0 | 0 | 0 | 1 |
| 6:45 PM | 1 | 0 | 0 | 0 | 0 | 1 | 0 | 0 | 0 | 0 | 0 | 0 | 0 | 0 | 6 | 0 | 0 | 6 | 1 | 1 | 0 | 0 | 0 | 0 | 2 |
| Total | 6 | 0 | 1 | 0 | 0 | 7 | 0 | 0 | 0 | 0 | 0 | 0 | 0 | 2 | 18 | 0 | 0 | 20 | 3 | 2 | 0 | 0 | 0 | 0 | 5 |
| Grand Total | 120 | 0 | 18 | 1 | 0 | 139 | 0 | 0 | 0 | 0 | 0 | 0 | 0 | 51 | 118 | 0 | 0 | 169 | 25 | 41 | 0 | 0 | 0 | 0 | 66 |
| Apprch % | 86.3 | 0.0 | 12.9 | 0.7 | 0.0 | | 0.0 | 0.0 | 0.0 | 0.0 | 0.0 | 0.0 | 0.0 | 30.2 | 69.8 | 0.0 | 0.0 | | 37.9 | 62.1 | 0.0 | 0.0 | 0.0 | 0.0 | |
| Total % | 32.1 | 0.0 | 4.8 | 0.3 | 0.0 | 37.2 | 0.0 | 0.0 | 0.0 | 0.0 | 0.0 | 0.0 | 0.0 | 13.6 | 31.6 | 0.0 | 0.0 | 45.2 | 6.7 | 11.0 | 0.0 | 0.0 | 0.0 | 0.0 | 17.6 |
| Cars, PU, Vans | 118 | 0 | 16 | 1 | 0 | 135 | 0 | 0 | 0 | 0 | 0 | 0 | 0 | 49 | 115 | 0 | 0 | 164 | 21 | 39 | 0 | 0 | 0 | 0 | 60 |
| % Cars, PU, Vans | 98.3 | 0.0 | 88.9 | 100.0 | 0.0 | 97.1 | 0.0 | 0.0 | 0.0 | 0.0 | 0.0 | 0.0 | 0.0 | 96.1 | 97.5 | 0.0 | 0.0 | 97.0 | 84.0 | 95.1 | 0.0 | 0.0 | 0.0 | 0.0 | 90.9 |
| Heavy trucks | 2 | 0 | 2 | 0 | 0 | 4 | 0 | 0 | 0 | 0 | 0 | 0 | 0 | 2 | 3 | 0 | 0 | 5 | 4 | 2 | 0 | 0 | 0 | 0 | 6 |

| | | | | | | | | | | | | | | | | | | | | | |
|---------------|-----|-----|------|-----|-----|-----|-----|-----|-----|-----|-----|-----|-----|-----|-----|------|-----|-----|-----|-----|-----|
| %Heavy trucks | 1.7 | 0.0 | 11.1 | 0.0 | 2.9 | 0.0 | 0.0 | 0.0 | 0.0 | 0.0 | 0.0 | 3.9 | 2.5 | 0.0 | 3.0 | 16.0 | 4.9 | 0.0 | 0.0 | 9.1 | 4.0 |
|---------------|-----|-----|------|-----|-----|-----|-----|-----|-----|-----|-----|-----|-----|-----|-----|------|-----|-----|-----|-----|-----|

Project ID: 22-180056-002
 Location: Cagle Mill Rd & Cagle Rd
 City: Lula

PEAK HOURS

Day: Wednesday
 Date: 3/30/2022

AM

| Start Time | Cagle Mill Rd Northbound | | | | | Cagle Mill Rd Southbound | | | | | Cagle Rd Eastbound | | | | | Cagle Rd Westbound | | | | | Int. Total |
|--|--------------------------|------|-------|------|------------|--------------------------|------|-----|------|------------|--------------------|-------|-------|------|------------|--------------------|-------|-----|------|------------|------------|
| | Left | Thru | Rgt | Utum | App. Total | Left | Thru | Rgt | Utum | App. Total | Left | Thru | Rgt | Utum | App. Total | Left | Thru | Rgt | Utum | App. Total | |
| Peak Hour Analysis from 07:00 AM - 10:00 AM | | | | | | | | | | | | | | | | | | | | | |
| Peak Hour for Entire Intersection Begins at 07:45 AM | | | | | | | | | | | | | | | | | | | | | |
| 7:45 AM | 3 | 0 | 0 | 0 | 3 | 0 | 0 | 0 | 0 | 0 | 0 | 0 | 0 | 0 | 0 | 2 | 1 | 0 | 0 | 3 | 6 |
| 8:00 AM | 3 | 0 | 0 | 0 | 3 | 0 | 0 | 0 | 0 | 0 | 0 | 0 | 0 | 0 | 0 | 0 | 3 | 0 | 0 | 3 | 6 |
| 8:15 AM | 3 | 0 | 0 | 0 | 3 | 0 | 0 | 0 | 0 | 0 | 0 | 1 | 3 | 0 | 4 | 0 | 0 | 0 | 0 | 0 | 7 |
| 8:30 AM | 4 | 0 | 1 | 0 | 5 | 0 | 0 | 0 | 0 | 0 | 0 | 2 | 3 | 0 | 5 | 0 | 3 | 0 | 0 | 3 | 13 |
| Total Volume | 13 | 0 | 1 | 0 | 14 | 0 | 0 | 0 | 0 | 0 | 0 | 3 | 6 | 0 | 9 | 2 | 7 | 0 | 0 | 9 | 32 |
| % App. Total | 92.9 | 0.0 | 7.1 | 0.0 | 100 | 0.0 | 0.0 | 0.0 | 0.0 | 0.0 | 0.0 | 33.3 | 66.7 | 0.0 | 100 | 22.2 | 77.8 | 0.0 | 0.0 | 100 | |
| PHF | 0.700 | | | | | | | | | | 0.450 | | | | | 0.750 | | | | | 0.615 |
| Cars, PU, Vans | 13 | 0 | 1 | 0 | 14 | 0 | 0 | 0 | 0 | 0 | 0 | 3 | 6 | 0 | 9 | 2 | 7 | 0 | 0 | 9 | 32 |
| % Cars, PU, Vans | 100.0 | 0.0 | 100.0 | 0.0 | 100.0 | 0.0 | 0.0 | 0.0 | 0.0 | 0.0 | 0.0 | 100.0 | 100.0 | 0.0 | 100.0 | 100.0 | 100.0 | 0.0 | 0.0 | 100.0 | 100.0 |
| Heavy trucks | 0 | 0 | 0 | 0 | 0 | 0 | 0 | 0 | 0 | 0 | 0 | 0 | 0 | 0 | 0 | 0 | 0 | 0 | 0 | 0 | 0 |
| %Heavy trucks | 0.0 | 0.0 | 0.0 | 0.0 | 0.0 | 0.0 | 0.0 | 0.0 | 0.0 | 0.0 | 0.0 | 0.0 | 0.0 | 0.0 | 0.0 | 0.0 | 0.0 | 0.0 | 0.0 | 0.0 | 0.0 |

NOON

| Start Time | Cagle Mill Rd Northbound | | | | | Cagle Mill Rd Southbound | | | | | Cagle Rd Eastbound | | | | | Cagle Rd Westbound | | | | | Int. Total |
|--|--------------------------|------|-----|------|------------|--------------------------|------|-----|------|------------|--------------------|-------|-------|------|------------|--------------------|-------|-----|------|------------|------------|
| | Left | Thru | Rgt | Utum | App. Total | Left | Thru | Rgt | Utum | App. Total | Left | Thru | Rgt | Utum | App. Total | Left | Thru | Rgt | Utum | App. Total | |
| Peak Hour Analysis from 10:00 AM - 02:00 PM | | | | | | | | | | | | | | | | | | | | | |
| Peak Hour for Entire Intersection Begins at 11:15 AM | | | | | | | | | | | | | | | | | | | | | |
| 11:15 AM | 9 | 0 | 0 | 0 | 9 | 0 | 0 | 0 | 0 | 0 | 0 | 0 | 4 | 0 | 4 | 0 | 1 | 0 | 0 | 1 | 14 |
| 11:30 AM | 3 | 0 | 0 | 0 | 3 | 0 | 0 | 0 | 0 | 0 | 0 | 0 | 1 | 0 | 1 | 0 | 0 | 0 | 0 | 0 | 4 |
| 11:45 AM | 5 | 0 | 0 | 0 | 5 | 0 | 0 | 0 | 0 | 0 | 0 | 1 | 1 | 0 | 2 | 0 | 0 | 0 | 0 | 0 | 7 |
| 12:00 PM | 2 | 0 | 0 | 0 | 2 | 0 | 0 | 0 | 0 | 0 | 0 | 2 | 3 | 0 | 5 | 0 | 1 | 0 | 0 | 1 | 8 |
| Total Volume | 19 | 0 | 0 | 0 | 19 | 0 | 0 | 0 | 0 | 0 | 0 | 3 | 9 | 0 | 12 | 0 | 2 | 0 | 0 | 2 | 33 |
| % App. Total | 100.0 | 0.0 | 0.0 | 0.0 | 100 | 0.0 | 0.0 | 0.0 | 0.0 | 0.0 | 0.0 | 25.0 | 75.0 | 0.0 | 100 | 0.0 | 100.0 | 0.0 | 0.0 | 100 | |
| PHF | 0.528 | | | | | | | | | | 0.600 | | | | | 0.500 | | | | | 0.589 |
| Cars, PU, Vans | 19 | 0 | 0 | 0 | 19 | 0 | 0 | 0 | 0 | 0 | 0 | 3 | 9 | 0 | 12 | 0 | 2 | 0 | 0 | 2 | 33 |
| % Cars, PU, Vans | 100.0 | 0.0 | 0.0 | 0.0 | 100.0 | 0.0 | 0.0 | 0.0 | 0.0 | 0.0 | 0.0 | 100.0 | 100.0 | 0.0 | 100.0 | 0.0 | 100.0 | 0.0 | 0.0 | 100.0 | 100.0 |
| Heavy trucks | 0 | 0 | 0 | 0 | 0 | 0 | 0 | 0 | 0 | 0 | 0 | 0 | 0 | 0 | 0 | 0 | 0 | 0 | 0 | 0 | 0 |
| %Heavy trucks | 0.0 | 0.0 | 0.0 | 0.0 | 0.0 | 0.0 | 0.0 | 0.0 | 0.0 | 0.0 | 0.0 | 0.0 | 0.0 | 0.0 | 0.0 | 0.0 | 0.0 | 0.0 | 0.0 | 0.0 | 0.0 |

PM

| Start Time | Cagle Mill Rd Northbound | | | | | Cagle Mill Rd Southbound | | | | | Cagle Rd Eastbound | | | | | Cagle Rd Westbound | | | | | Int. Total |
|--|--------------------------|------|-------|------|------------|--------------------------|------|-----|------|------------|--------------------|-------|-------|------|------------|--------------------|-------|-----|------|------------|------------|
| | Left | Thru | Rgt | Utum | App. Total | Left | Thru | Rgt | Utum | App. Total | Left | Thru | Rgt | Utum | App. Total | Left | Thru | Rgt | Utum | App. Total | |
| Peak Hour Analysis from 02:00 PM - 07:00 PM | | | | | | | | | | | | | | | | | | | | | |
| Peak Hour for Entire Intersection Begins at 04:30 PM | | | | | | | | | | | | | | | | | | | | | |
| 4:30 PM | 2 | 0 | 3 | 0 | 5 | 0 | 0 | 0 | 0 | 0 | 0 | 8 | 1 | 0 | 9 | 0 | 0 | 0 | 0 | 0 | 14 |
| 4:45 PM | 0 | 0 | 1 | 0 | 1 | 0 | 0 | 0 | 0 | 0 | 0 | 4 | 4 | 0 | 8 | 1 | 3 | 0 | 0 | 4 | 13 |
| 5:00 PM | 4 | 0 | 0 | 0 | 4 | 0 | 0 | 0 | 0 | 0 | 0 | 1 | 3 | 0 | 4 | 0 | 2 | 0 | 0 | 2 | 10 |
| 5:15 PM | 4 | 0 | 1 | 0 | 5 | 0 | 0 | 0 | 0 | 0 | 0 | 2 | 6 | 0 | 8 | 1 | 1 | 0 | 0 | 2 | 15 |
| Total Volume | 10 | 0 | 5 | 0 | 15 | 0 | 0 | 0 | 0 | 0 | 0 | 15 | 14 | 0 | 29 | 2 | 6 | 0 | 0 | 8 | 52 |
| % App. Total | 66.7 | 0.0 | 33.3 | 0.0 | 100 | 0.0 | 0.0 | 0.0 | 0.0 | 0.0 | 0.0 | 51.7 | 48.3 | 0.0 | 100 | 25.0 | 75.0 | 0.0 | 0.0 | 100 | |
| PHF | 0.750 | | | | | | | | | | 0.806 | | | | | 0.500 | | | | | 0.867 |
| Cars, PU, Vans | 10 | 0 | 5 | 0 | 15 | 0 | 0 | 0 | 0 | 0 | 0 | 15 | 14 | 0 | 29 | 2 | 6 | 0 | 0 | 8 | 52 |
| % Cars, PU, Vans | 100.0 | 0.0 | 100.0 | 0.0 | 100.0 | 0.0 | 0.0 | 0.0 | 0.0 | 0.0 | 0.0 | 100.0 | 100.0 | 0.0 | 100.0 | 100.0 | 100.0 | 0.0 | 0.0 | 100.0 | 100.0 |
| Heavy trucks | 0 | 0 | 0 | 0 | 0 | 0 | 0 | 0 | 0 | 0 | 0 | 0 | 0 | 0 | 0 | 0 | 0 | 0 | 0 | 0 | 0 |
| %Heavy trucks | 0.0 | 0.0 | 0.0 | 0.0 | 0.0 | 0.0 | 0.0 | 0.0 | 0.0 | 0.0 | 0.0 | 0.0 | 0.0 | 0.0 | 0.0 | 0.0 | 0.0 | 0.0 | 0.0 | 0.0 | 0.0 |

National Data & Surveying Services Intersection Turning Movement Count

Location: Julian Baugh Rd & Cagle Mill Rd
 City: Lula
 Control: 1-Way Stop (EB)

Project ID: 22-180056-003
 Date: 3/30/2022

Data - Bikes

| NS/EW Streets: | Julian Baugh Rd | | | | Julian Baugh Rd | | | | Cagle Mill Rd | | | | Cagle Mill Rd | | | | |
|-----------------------------------|---------------------|-------|-------|-------|-----------------|-------|-------|-------|---------------|-------|-------|-------|---------------|-------|-------|-------|-------|
| AM | NORTHBOUND | | | | SOUTHBOUND | | | | EASTBOUND | | | | WESTBOUND | | | | |
| | NL | NT | NR | NU | SL | ST | SR | SU | EL | ET | ER | EU | WL | WT | WR | WU | TOTAL |
| 7:00 AM | 0 | 0 | 0 | 0 | 0 | 0 | 0 | 0 | 0 | 0 | 0 | 0 | 0 | 0 | 0 | 0 | 0 |
| 7:15 AM | 0 | 0 | 0 | 0 | 0 | 0 | 0 | 0 | 0 | 0 | 0 | 0 | 0 | 0 | 0 | 0 | 0 |
| 7:30 AM | 0 | 0 | 0 | 0 | 0 | 0 | 0 | 0 | 0 | 0 | 0 | 0 | 0 | 0 | 0 | 0 | 0 |
| 7:45 AM | 0 | 0 | 0 | 0 | 0 | 0 | 0 | 0 | 0 | 0 | 0 | 0 | 0 | 0 | 0 | 0 | 0 |
| 8:00 AM | 0 | 0 | 0 | 0 | 0 | 0 | 0 | 0 | 0 | 0 | 0 | 0 | 0 | 0 | 0 | 0 | 0 |
| 8:15 AM | 0 | 0 | 0 | 0 | 0 | 0 | 0 | 0 | 0 | 0 | 0 | 0 | 0 | 0 | 0 | 0 | 0 |
| 8:30 AM | 0 | 0 | 0 | 0 | 0 | 0 | 0 | 0 | 0 | 0 | 0 | 0 | 0 | 0 | 0 | 0 | 0 |
| 8:45 AM | 0 | 0 | 0 | 0 | 0 | 0 | 0 | 0 | 0 | 0 | 0 | 0 | 0 | 0 | 0 | 0 | 0 |
| 9:00 AM | 0 | 0 | 0 | 0 | 0 | 0 | 0 | 0 | 0 | 0 | 0 | 0 | 0 | 0 | 0 | 0 | 0 |
| 9:15 AM | 0 | 0 | 0 | 0 | 0 | 0 | 0 | 0 | 0 | 0 | 0 | 0 | 0 | 0 | 0 | 0 | 0 |
| 9:30 AM | 0 | 0 | 0 | 0 | 0 | 0 | 0 | 0 | 0 | 0 | 0 | 0 | 0 | 0 | 0 | 0 | 0 |
| 9:45 AM | 0 | 0 | 0 | 0 | 0 | 0 | 0 | 0 | 0 | 0 | 0 | 0 | 0 | 0 | 0 | 0 | 0 |
| TOTAL VOLUMES : APPROACH %'s : | NL | NT | NR | NU | SL | ST | SR | SU | EL | ET | ER | EU | WL | WT | WR | WU | TOTAL |
| | 0 | 0 | 0 | 0 | 0 | 0 | 0 | 0 | 0 | 0 | 0 | 0 | 0 | 0 | 0 | 0 | 0 |
| PEAK HR : | 07:45 AM - 08:45 AM | | | | | | | | | | | | | | | | TOTAL |
| PEAK HR VOL : | 0 | 0 | 0 | 0 | 0 | 0 | 0 | 0 | 0 | 0 | 0 | 0 | 0 | 0 | 0 | 0 | 0 |
| PEAK HR FACTOR : | 0.000 | 0.000 | 0.000 | 0.000 | 0.000 | 0.000 | 0.000 | 0.000 | 0.000 | 0.000 | 0.000 | 0.000 | 0.000 | 0.000 | 0.000 | 0.000 | 0.000 |
| | | | | | | | | | | | | | | | | | |
| NOON | NORTHBOUND | | | | SOUTHBOUND | | | | EASTBOUND | | | | WESTBOUND | | | | |
| | NL | NT | NR | NU | SL | ST | SR | SU | EL | ET | ER | EU | WL | WT | WR | WU | TOTAL |
| 10:00 AM | 0 | 0 | 0 | 0 | 0 | 0 | 0 | 0 | 0 | 0 | 0 | 0 | 0 | 0 | 0 | 0 | 0 |
| 10:15 AM | 0 | 0 | 0 | 0 | 0 | 0 | 0 | 0 | 0 | 0 | 0 | 0 | 0 | 0 | 0 | 0 | 0 |
| 10:30 AM | 0 | 0 | 0 | 0 | 0 | 0 | 0 | 0 | 0 | 0 | 0 | 0 | 0 | 0 | 0 | 0 | 0 |
| 10:45 AM | 0 | 0 | 0 | 0 | 0 | 0 | 0 | 0 | 0 | 0 | 0 | 0 | 0 | 0 | 0 | 0 | 0 |
| 11:00 AM | 0 | 0 | 0 | 0 | 0 | 0 | 0 | 0 | 0 | 0 | 0 | 0 | 0 | 0 | 0 | 0 | 0 |
| 11:15 AM | 0 | 0 | 0 | 0 | 0 | 0 | 0 | 0 | 0 | 0 | 0 | 0 | 0 | 0 | 0 | 0 | 0 |
| 11:30 AM | 0 | 0 | 0 | 0 | 0 | 0 | 0 | 0 | 0 | 0 | 0 | 0 | 0 | 0 | 0 | 0 | 0 |
| 11:45 AM | 0 | 0 | 0 | 0 | 0 | 0 | 0 | 0 | 0 | 0 | 0 | 0 | 0 | 0 | 0 | 0 | 0 |
| 12:00 PM | 0 | 0 | 0 | 0 | 0 | 0 | 0 | 0 | 0 | 0 | 0 | 0 | 0 | 0 | 0 | 0 | 0 |
| 12:15 PM | 0 | 0 | 0 | 0 | 0 | 0 | 0 | 0 | 0 | 0 | 0 | 0 | 0 | 0 | 0 | 0 | 0 |
| 12:30 PM | 0 | 0 | 0 | 0 | 0 | 0 | 0 | 0 | 0 | 0 | 0 | 0 | 0 | 0 | 0 | 0 | 0 |
| 12:45 PM | 0 | 0 | 0 | 0 | 0 | 0 | 0 | 0 | 0 | 0 | 0 | 0 | 0 | 0 | 0 | 0 | 0 |
| 1:00 PM | 0 | 0 | 0 | 0 | 0 | 0 | 0 | 0 | 0 | 0 | 0 | 0 | 0 | 0 | 0 | 0 | 0 |
| 1:15 PM | 0 | 0 | 0 | 0 | 0 | 0 | 0 | 0 | 0 | 0 | 0 | 0 | 0 | 0 | 0 | 0 | 0 |
| 1:30 PM | 0 | 0 | 0 | 0 | 0 | 0 | 0 | 0 | 0 | 0 | 0 | 0 | 0 | 0 | 0 | 0 | 0 |
| 1:45 PM | 0 | 0 | 0 | 0 | 0 | 0 | 0 | 0 | 0 | 0 | 0 | 0 | 0 | 0 | 0 | 0 | 0 |
| TOTAL VOLUMES : APPROACH %'s : | NL | NT | NR | NU | SL | ST | SR | SU | EL | ET | ER | EU | WL | WT | WR | WU | TOTAL |
| | 0 | 0 | 0 | 0 | 0 | 0 | 0 | 0 | 0 | 0 | 0 | 0 | 0 | 0 | 0 | 0 | 0 |
| PEAK HR : | 10:45 AM - 11:45 AM | | | | | | | | | | | | | | | | TOTAL |
| PEAK HR VOL : | 0 | 0 | 0 | 0 | 0 | 0 | 0 | 0 | 0 | 0 | 0 | 0 | 0 | 0 | 0 | 0 | 0 |
| PEAK HR FACTOR : | 0.000 | 0.000 | 0.000 | 0.000 | 0.000 | 0.000 | 0.000 | 0.000 | 0.000 | 0.000 | 0.000 | 0.000 | 0.000 | 0.000 | 0.000 | 0.000 | 0.000 |
| | | | | | | | | | | | | | | | | | |
| PM | NORTHBOUND | | | | SOUTHBOUND | | | | EASTBOUND | | | | WESTBOUND | | | | |
| | NL | NT | NR | NU | SL | ST | SR | SU | EL | ET | ER | EU | WL | WT | WR | WU | TOTAL |
| 2:00 PM | 0 | 0 | 0 | 0 | 0 | 0 | 0 | 0 | 0 | 0 | 0 | 0 | 0 | 0 | 0 | 0 | 0 |
| 2:15 PM | 0 | 0 | 0 | 0 | 0 | 0 | 0 | 0 | 0 | 0 | 0 | 0 | 0 | 0 | 0 | 0 | 0 |
| 2:30 PM | 0 | 0 | 0 | 0 | 0 | 0 | 0 | 0 | 0 | 0 | 0 | 0 | 0 | 0 | 0 | 0 | 0 |
| 2:45 PM | 0 | 0 | 0 | 0 | 0 | 0 | 0 | 0 | 0 | 0 | 0 | 0 | 0 | 0 | 0 | 0 | 0 |
| 3:00 PM | 0 | 0 | 0 | 0 | 0 | 0 | 0 | 0 | 0 | 0 | 0 | 0 | 0 | 0 | 0 | 0 | 0 |
| 3:15 PM | 0 | 0 | 0 | 0 | 0 | 0 | 0 | 0 | 0 | 0 | 0 | 0 | 0 | 0 | 0 | 0 | 0 |
| 3:30 PM | 0 | 0 | 0 | 0 | 0 | 0 | 0 | 0 | 0 | 0 | 0 | 0 | 0 | 0 | 0 | 0 | 0 |
| 3:45 PM | 0 | 0 | 0 | 0 | 0 | 0 | 0 | 0 | 0 | 0 | 0 | 0 | 0 | 0 | 0 | 0 | 0 |
| 4:00 PM | 0 | 0 | 0 | 0 | 0 | 0 | 0 | 0 | 0 | 0 | 0 | 0 | 0 | 0 | 0 | 0 | 0 |
| 4:15 PM | 0 | 0 | 0 | 0 | 0 | 0 | 0 | 0 | 0 | 0 | 0 | 0 | 0 | 0 | 0 | 0 | 0 |
| 4:30 PM | 0 | 0 | 0 | 0 | 0 | 0 | 0 | 0 | 0 | 0 | 0 | 0 | 0 | 0 | 0 | 0 | 0 |
| 4:45 PM | 0 | 0 | 0 | 0 | 0 | 0 | 0 | 0 | 0 | 0 | 0 | 0 | 0 | 0 | 0 | 0 | 0 |
| 5:00 PM | 0 | 0 | 0 | 0 | 0 | 0 | 0 | 0 | 0 | 0 | 0 | 0 | 0 | 0 | 0 | 0 | 0 |
| 5:15 PM | 0 | 0 | 0 | 0 | 0 | 0 | 0 | 0 | 0 | 0 | 0 | 0 | 0 | 0 | 0 | 0 | 0 |
| 5:30 PM | 0 | 0 | 0 | 0 | 0 | 0 | 0 | 0 | 0 | 0 | 0 | 0 | 0 | 0 | 0 | 0 | 0 |
| 5:45 PM | 0 | 0 | 0 | 0 | 0 | 0 | 0 | 0 | 0 | 0 | 0 | 0 | 0 | 0 | 0 | 0 | 0 |
| 6:00 PM | 0 | 0 | 0 | 0 | 0 | 0 | 0 | 0 | 0 | 0 | 0 | 0 | 0 | 0 | 0 | 0 | 0 |
| 6:15 PM | 0 | 0 | 0 | 0 | 0 | 0 | 0 | 0 | 0 | 0 | 0 | 0 | 0 | 0 | 0 | 0 | 0 |
| 6:30 PM | 0 | 0 | 0 | 0 | 0 | 0 | 0 | 0 | 0 | 0 | 0 | 0 | 0 | 0 | 0 | 0 | 0 |
| 6:45 PM | 0 | 0 | 0 | 0 | 0 | 0 | 0 | 0 | 0 | 0 | 0 | 0 | 0 | 0 | 0 | 0 | 0 |
| TOTAL VOLUMES : APPROACH %'s : | NL | NT | NR | NU | SL | ST | SR | SU | EL | ET | ER | EU | WL | WT | WR | WU | TOTAL |
| | 0 | 0 | 0 | 0 | 0 | 0 | 0 | 0 | 0 | 0 | 0 | 0 | 0 | 0 | 0 | 0 | 0 |
| PEAK HR : | 05:15 PM - 06:15 PM | | | | | | | | | | | | | | | | TOTAL |
| PEAK HR VOL : | 0 | 0 | 0 | 0 | 0 | 0 | 0 | 0 | 0 | 0 | 0 | 0 | 0 | 0 | 0 | 0 | 0 |
| PEAK HR FACTOR : | 0.000 | 0.000 | 0.000 | 0.000 | 0.000 | 0.000 | 0.000 | 0.000 | 0.000 | 0.000 | 0.000 | 0.000 | 0.000 | 0.000 | 0.000 | 0.000 | 0.000 |

Julian Baugh Rd & Cagle Mill Rd

Peak Hour Turning Movement Count

ID: 22-180056-003
City: Lula

Day: Wednesday
Date: 3/30/2022

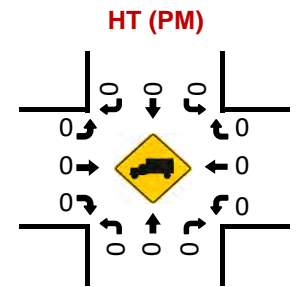
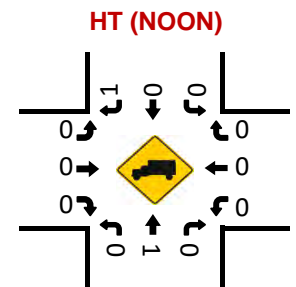
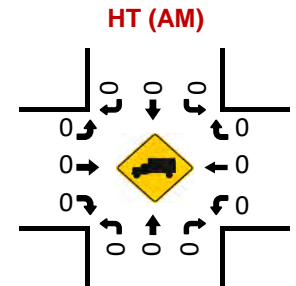
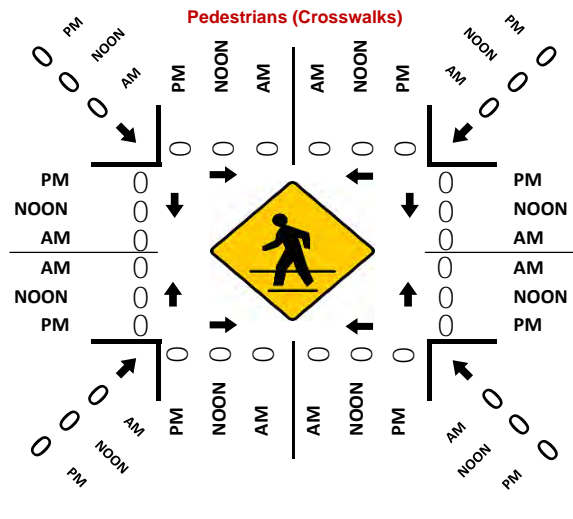
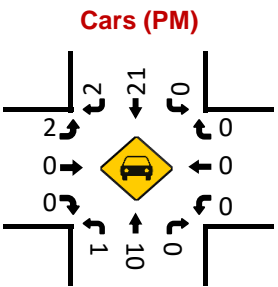
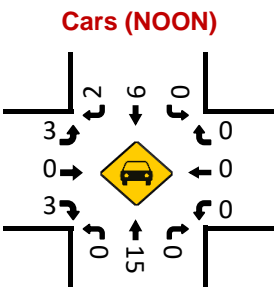
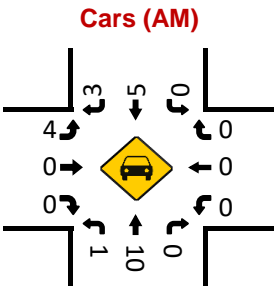
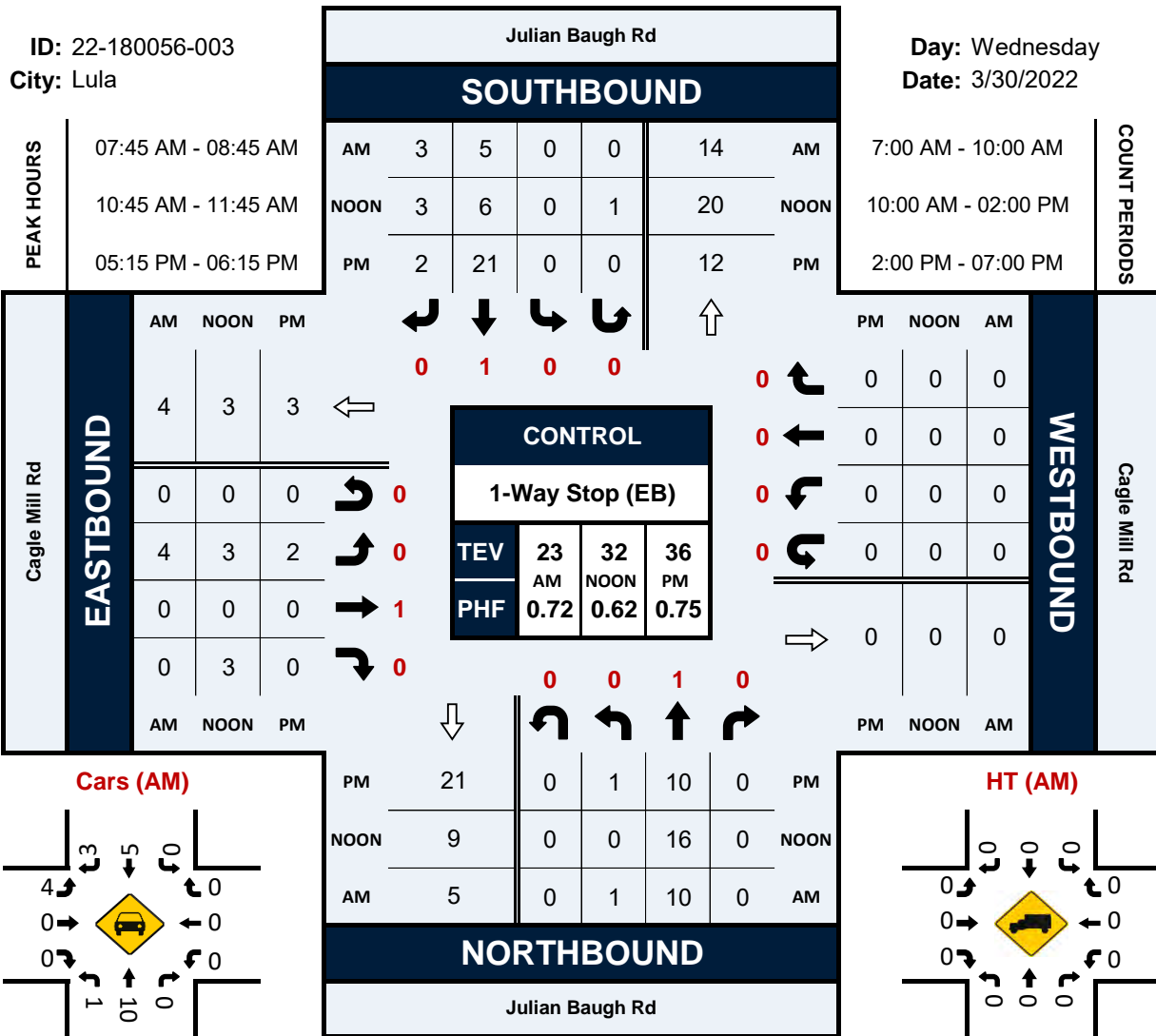

Project ID: 22-180056-003
 Location: Julian Baugh Rd & Cagle Mill Rd
 City: Lula

Day: Wednesday
 Date: 3/30/2022

Groups Printed - Cars, PU, Vans - Heavy Trucks

| Start Time | Julian Baugh Rd Northbound | | | | | | Julian Baugh Rd Southbound | | | | | | Cagle Mill Rd Eastbound | | | | | | Cagle Mill Rd Westbound | | | | | | Int. Total |
|------------------|----------------------------|------|-----|------|------|------------|----------------------------|------|------|------|------|------------|-------------------------|------|-------|------|------|------------|-------------------------|------|-----|------|------|------------|------------|
| | Left | Thru | Rgt | Utum | Peds | App. Total | Left | Thru | Rgt | Utum | Peds | App. Total | Left | Thru | Rgt | Utum | Peds | App. Total | Left | Thru | Rgt | Utum | Peds | App. Total | |
| 7:00 AM | 0 | 1 | 0 | 0 | 0 | 1 | 0 | 1 | 0 | 0 | 0 | 1 | 0 | 0 | 0 | 0 | 0 | 0 | 0 | 0 | 0 | 0 | 0 | 0 | 2 |
| 7:15 AM | 0 | 8 | 0 | 0 | 0 | 8 | 0 | 0 | 0 | 0 | 0 | 0 | 0 | 0 | 0 | 0 | 0 | 0 | 0 | 0 | 0 | 0 | 0 | 0 | 8 |
| 7:30 AM | 0 | 4 | 0 | 0 | 0 | 4 | 0 | 1 | 0 | 0 | 0 | 1 | 1 | 0 | 0 | 0 | 0 | 0 | 1 | 0 | 0 | 0 | 0 | 0 | 6 |
| 7:45 AM | 0 | 2 | 0 | 0 | 0 | 2 | 0 | 2 | 0 | 0 | 0 | 2 | 1 | 0 | 0 | 0 | 0 | 1 | 0 | 0 | 0 | 0 | 0 | 0 | 5 |
| Total | 0 | 15 | 0 | 0 | 0 | 15 | 0 | 4 | 0 | 0 | 0 | 4 | 2 | 0 | 0 | 0 | 0 | 2 | 0 | 0 | 0 | 0 | 0 | 0 | 21 |
| 8:00 AM | 1 | 3 | 0 | 0 | 0 | 4 | 0 | 0 | 0 | 0 | 0 | 0 | 0 | 0 | 0 | 0 | 0 | 0 | 0 | 0 | 0 | 0 | 0 | 0 | 4 |
| 8:15 AM | 0 | 2 | 0 | 0 | 0 | 2 | 0 | 2 | 1 | 0 | 0 | 3 | 1 | 0 | 0 | 0 | 0 | 1 | 0 | 0 | 0 | 0 | 0 | 0 | 6 |
| 8:30 AM | 0 | 3 | 0 | 0 | 0 | 3 | 0 | 1 | 2 | 0 | 0 | 3 | 2 | 0 | 0 | 0 | 0 | 2 | 0 | 0 | 0 | 0 | 0 | 0 | 8 |
| 8:45 AM | 0 | 1 | 0 | 0 | 0 | 1 | 0 | 0 | 0 | 0 | 0 | 0 | 2 | 0 | 0 | 0 | 0 | 2 | 0 | 0 | 0 | 0 | 0 | 0 | 3 |
| Total | 1 | 9 | 0 | 0 | 0 | 10 | 0 | 3 | 3 | 0 | 0 | 6 | 5 | 0 | 0 | 0 | 0 | 5 | 0 | 0 | 0 | 0 | 0 | 0 | 21 |
| 9:00 AM | 0 | 2 | 0 | 0 | 0 | 2 | 0 | 1 | 1 | 0 | 0 | 2 | 0 | 0 | 0 | 0 | 0 | 0 | 0 | 0 | 0 | 0 | 0 | 0 | 4 |
| 9:15 AM | 0 | 0 | 0 | 0 | 0 | 0 | 0 | 1 | 0 | 0 | 0 | 1 | 0 | 0 | 0 | 0 | 0 | 0 | 0 | 0 | 0 | 0 | 0 | 0 | 1 |
| 9:30 AM | 0 | 3 | 0 | 0 | 0 | 3 | 0 | 3 | 1 | 0 | 0 | 4 | 1 | 0 | 0 | 0 | 0 | 1 | 0 | 0 | 0 | 0 | 0 | 0 | 8 |
| 9:45 AM | 0 | 1 | 0 | 0 | 0 | 1 | 0 | 0 | 0 | 0 | 0 | 0 | 0 | 0 | 1 | 0 | 0 | 1 | 0 | 0 | 0 | 0 | 0 | 0 | 2 |
| Total | 0 | 6 | 0 | 0 | 0 | 6 | 0 | 5 | 2 | 0 | 0 | 7 | 1 | 0 | 1 | 0 | 0 | 2 | 0 | 0 | 0 | 0 | 0 | 0 | 15 |
| ***BREAK*** | | | | | | | | | | | | | | | | | | | | | | | | | |
| 10:00 AM | 0 | 0 | 0 | 0 | 0 | 0 | 0 | 2 | 1 | 0 | 0 | 3 | 0 | 0 | 1 | 0 | 0 | 1 | 0 | 0 | 0 | 0 | 0 | 0 | 4 |
| 10:15 AM | 0 | 1 | 0 | 0 | 0 | 1 | 0 | 1 | 2 | 0 | 0 | 3 | 0 | 0 | 0 | 0 | 0 | 0 | 0 | 0 | 0 | 0 | 0 | 0 | 4 |
| 10:30 AM | 1 | 1 | 0 | 0 | 0 | 2 | 0 | 1 | 1 | 0 | 0 | 2 | 1 | 0 | 0 | 0 | 0 | 1 | 0 | 0 | 0 | 0 | 0 | 0 | 5 |
| 10:45 AM | 0 | 5 | 0 | 0 | 0 | 5 | 0 | 2 | 0 | 1 | 0 | 3 | 0 | 0 | 0 | 0 | 0 | 0 | 0 | 0 | 0 | 0 | 0 | 0 | 8 |
| Total | 1 | 7 | 0 | 0 | 0 | 8 | 0 | 6 | 4 | 1 | 0 | 11 | 1 | 0 | 1 | 0 | 0 | 2 | 0 | 0 | 0 | 0 | 0 | 0 | 21 |
| 11:00 AM | 0 | 2 | 0 | 0 | 0 | 2 | 0 | 1 | 1 | 0 | 0 | 2 | 0 | 0 | 2 | 0 | 0 | 2 | 0 | 0 | 0 | 0 | 0 | 0 | 6 |
| 11:15 AM | 0 | 7 | 0 | 0 | 0 | 7 | 0 | 2 | 2 | 0 | 0 | 4 | 2 | 0 | 0 | 0 | 0 | 2 | 0 | 0 | 0 | 0 | 0 | 0 | 13 |
| 11:30 AM | 0 | 2 | 0 | 0 | 0 | 2 | 0 | 1 | 0 | 0 | 0 | 1 | 1 | 0 | 1 | 0 | 0 | 2 | 0 | 0 | 0 | 0 | 0 | 0 | 5 |
| 11:45 AM | 1 | 4 | 0 | 0 | 0 | 5 | 0 | 1 | 0 | 0 | 0 | 1 | 1 | 0 | 0 | 0 | 0 | 1 | 0 | 0 | 0 | 0 | 0 | 0 | 7 |
| Total | 1 | 15 | 0 | 0 | 0 | 16 | 0 | 5 | 3 | 0 | 0 | 8 | 4 | 0 | 3 | 0 | 0 | 7 | 0 | 0 | 0 | 0 | 0 | 0 | 31 |
| 12:00 PM | 0 | 2 | 0 | 0 | 0 | 2 | 0 | 3 | 0 | 0 | 0 | 3 | 0 | 0 | 1 | 0 | 0 | 1 | 0 | 0 | 0 | 0 | 0 | 0 | 6 |
| 12:15 PM | 0 | 1 | 0 | 0 | 0 | 1 | 0 | 1 | 0 | 0 | 0 | 1 | 0 | 0 | 0 | 0 | 0 | 0 | 0 | 0 | 0 | 0 | 0 | 0 | 2 |
| 12:30 PM | 0 | 2 | 0 | 0 | 0 | 2 | 0 | 4 | 1 | 0 | 0 | 5 | 0 | 0 | 0 | 0 | 0 | 0 | 0 | 0 | 0 | 0 | 0 | 0 | 7 |
| 12:45 PM | 0 | 3 | 0 | 0 | 0 | 3 | 0 | 3 | 0 | 0 | 0 | 3 | 1 | 0 | 0 | 0 | 0 | 1 | 0 | 0 | 0 | 0 | 0 | 0 | 7 |
| Total | 0 | 8 | 0 | 0 | 0 | 8 | 0 | 11 | 1 | 0 | 0 | 12 | 1 | 0 | 1 | 0 | 0 | 2 | 0 | 0 | 0 | 0 | 0 | 0 | 22 |
| 1:00 PM | 0 | 2 | 0 | 0 | 0 | 2 | 0 | 2 | 0 | 0 | 0 | 2 | 2 | 0 | 0 | 0 | 0 | 2 | 0 | 0 | 0 | 0 | 0 | 0 | 6 |
| 1:15 PM | 0 | 2 | 0 | 0 | 0 | 2 | 0 | 1 | 1 | 0 | 0 | 2 | 0 | 0 | 0 | 0 | 0 | 0 | 0 | 0 | 0 | 0 | 0 | 0 | 4 |
| 1:30 PM | 0 | 0 | 0 | 0 | 0 | 0 | 0 | 2 | 1 | 0 | 0 | 3 | 0 | 0 | 0 | 0 | 0 | 0 | 0 | 0 | 0 | 0 | 0 | 0 | 3 |
| 1:45 PM | 0 | 2 | 0 | 0 | 0 | 2 | 0 | 2 | 1 | 0 | 0 | 3 | 2 | 0 | 0 | 0 | 0 | 2 | 0 | 0 | 0 | 0 | 0 | 0 | 7 |
| Total | 0 | 6 | 0 | 0 | 0 | 6 | 0 | 7 | 3 | 0 | 0 | 10 | 4 | 0 | 0 | 0 | 0 | 4 | 0 | 0 | 0 | 0 | 0 | 0 | 20 |
| ***BREAK*** | | | | | | | | | | | | | | | | | | | | | | | | | |
| 2:00 PM | 0 | 2 | 0 | 0 | 0 | 2 | 0 | 5 | 1 | 0 | 0 | 6 | 1 | 0 | 0 | 0 | 0 | 1 | 0 | 0 | 0 | 0 | 0 | 0 | 9 |
| 2:15 PM | 0 | 4 | 0 | 0 | 0 | 4 | 0 | 0 | 1 | 0 | 0 | 1 | 1 | 0 | 0 | 0 | 0 | 1 | 0 | 0 | 0 | 0 | 0 | 0 | 6 |
| 2:30 PM | 0 | 2 | 0 | 0 | 0 | 2 | 0 | 2 | 0 | 0 | 0 | 2 | 0 | 0 | 0 | 1 | 0 | 1 | 0 | 0 | 0 | 0 | 0 | 0 | 5 |
| 2:45 PM | 0 | 2 | 0 | 0 | 0 | 2 | 0 | 4 | 2 | 0 | 0 | 6 | 1 | 0 | 0 | 0 | 0 | 1 | 0 | 0 | 0 | 0 | 0 | 0 | 9 |
| Total | 0 | 10 | 0 | 0 | 0 | 10 | 0 | 11 | 4 | 0 | 0 | 15 | 3 | 0 | 0 | 1 | 0 | 4 | 0 | 0 | 0 | 0 | 0 | 0 | 29 |
| 3:00 PM | 0 | 1 | 0 | 0 | 0 | 1 | 0 | 1 | 0 | 0 | 0 | 1 | 0 | 0 | 0 | 0 | 0 | 0 | 0 | 0 | 0 | 0 | 0 | 0 | 2 |
| 3:15 PM | 1 | 2 | 0 | 0 | 0 | 3 | 0 | 2 | 0 | 0 | 0 | 2 | 1 | 0 | 0 | 0 | 0 | 1 | 0 | 0 | 0 | 0 | 0 | 0 | 6 |
| 3:30 PM | 0 | 2 | 0 | 0 | 0 | 2 | 0 | 4 | 1 | 0 | 0 | 5 | 1 | 0 | 1 | 0 | 0 | 2 | 0 | 0 | 0 | 0 | 0 | 0 | 9 |
| 3:45 PM | 0 | 1 | 0 | 0 | 0 | 1 | 0 | 1 | 5 | 0 | 0 | 6 | 1 | 0 | 0 | 0 | 0 | 1 | 0 | 0 | 0 | 0 | 0 | 0 | 8 |
| Total | 1 | 6 | 0 | 0 | 0 | 7 | 0 | 8 | 6 | 0 | 0 | 14 | 3 | 0 | 1 | 0 | 0 | 4 | 0 | 0 | 0 | 0 | 0 | 0 | 25 |
| 4:00 PM | 0 | 1 | 0 | 0 | 0 | 1 | 0 | 4 | 2 | 0 | 0 | 6 | 0 | 0 | 0 | 0 | 0 | 0 | 0 | 0 | 0 | 0 | 0 | 0 | 7 |
| 4:15 PM | 0 | 4 | 0 | 0 | 0 | 4 | 0 | 2 | 1 | 0 | 0 | 3 | 1 | 0 | 0 | 0 | 0 | 1 | 0 | 0 | 0 | 0 | 0 | 0 | 8 |
| 4:30 PM | 0 | 4 | 0 | 0 | 0 | 4 | 0 | 1 | 0 | 0 | 0 | 1 | 1 | 0 | 0 | 0 | 0 | 1 | 0 | 0 | 0 | 0 | 0 | 0 | 6 |
| 4:45 PM | 0 | 1 | 0 | 0 | 0 | 1 | 0 | 3 | 2 | 0 | 0 | 5 | 0 | 0 | 0 | 0 | 0 | 0 | 0 | 0 | 0 | 0 | 0 | 0 | 6 |
| Total | 0 | 10 | 0 | 0 | 0 | 10 | 0 | 10 | 5 | 0 | 0 | 15 | 2 | 0 | 0 | 0 | 0 | 2 | 0 | 0 | 0 | 0 | 0 | 0 | 27 |
| 5:00 PM | 0 | 2 | 0 | 0 | 0 | 2 | 0 | 3 | 0 | 0 | 0 | 3 | 2 | 0 | 0 | 0 | 0 | 2 | 0 | 0 | 0 | 0 | 0 | 0 | 7 |
| 5:15 PM | 0 | 5 | 0 | 0 | 0 | 5 | 0 | 7 | 0 | 0 | 0 | 7 | 0 | 0 | 0 | 0 | 0 | 0 | 0 | 0 | 0 | 0 | 0 | 0 | 12 |
| 5:30 PM | 1 | 3 | 0 | 0 | 0 | 4 | 0 | 2 | 0 | 0 | 0 | 2 | 0 | 0 | 0 | 0 | 0 | 0 | 0 | 0 | 0 | 0 | 0 | 0 | 6 |
| 5:45 PM | 0 | 1 | 0 | 0 | 0 | 1 | 0 | 8 | 1 | 0 | 0 | 9 | 0 | 0 | 0 | 0 | 0 | 0 | 0 | 0 | 0 | 0 | 0 | 0 | 10 |
| Total | 1 | 11 | 0 | 0 | 0 | 12 | 0 | 20 | 1 | 0 | 0 | 21 | 2 | 0 | 0 | 0 | 0 | 2 | 0 | 0 | 0 | 0 | 0 | 0 | 35 |
| 6:00 PM | 0 | 1 | 0 | 0 | 0 | 1 | 0 | 4 | 1 | 0 | 0 | 5 | 2 | 0 | 0 | 0 | 0 | 2 | 0 | 0 | 0 | 0 | 0 | 0 | 8 |
| 6:15 PM | 0 | 2 | 0 | 0 | 0 | 2 | 0 | 2 | 2 | 0 | 0 | 4 | 0 | 0 | 0 | 0 | 0 | 0 | 0 | 0 | 0 | 0 | 0 | 0 | 6 |
| 6:30 PM | 0 | 0 | 0 | 0 | 0 | 0 | 0 | 3 | 2 | 0 | 0 | 5 | 1 | 0 | 0 | 0 | 0 | 1 | 0 | 0 | 0 | 0 | 0 | 0 | 6 |
| 6:45 PM | 0 | 1 | 0 | 0 | 0 | 1 | 0 | 6 | 1 | 0 | 0 | 7 | 0 | 0 | 1 | 0 | 0 | 1 | 0 | 0 | 0 | 0 | 0 | 0 | 9 |
| Total | 0 | 4 | 0 | 0 | 0 | 4 | 0 | 15 | 6 | 0 | 0 | 21 | 3 | 0 | 1 | 0 | 0 | 4 | 0 | 0 | 0 | 0 | 0 | 0 | 29 |
| Grand Total | 5 | 107 | 0 | 0 | 0 | 112 | 0 | 105 | 38 | 1 | 0 | 144 | 31 | 0 | 8 | 1 | 0 | 40 | 0 | 0 | 0 | 0 | 0 | 0 | 296 |
| Apprch % | 4.5 | 95.5 | 0.0 | 0.0 | 0.0 | | 0.0 | 72.9 | 26.4 | 0.7 | 0.0 | | 77.5 | 0.0 | 20.0 | 2.5 | 0.0 | | 0.0 | 0.0 | 0.0 | 0.0 | 0.0 | | |
| Total % | 1.7 | 36.1 | 0.0 | 0.0 | 0.0 | 37.8 | 0.0 | 35.5 | 12.8 | 0.3 | 0.0 | 48.6 | 10.5 | 0.0 | 2.7 | 0.3 | 0.0 | 13.5 | 0.0 | 0.0 | 0.0 | 0.0 | 0.0 | 0.0 | |
| Cars, PU, Vans | 5 | 104 | 0 | 0 | 0 | 109 | 0 | 101 | 36 | 0 | 0 | 137 | 31 | 0 | 7 | 1 | 0 | 39 | 0 | 0 | 0 | 0 | 0 | 0 | 285 |
| % Cars, PU, Vans | 100.0 | 97.2 | 0.0 | 0.0 | 0.0 | 97.3 | 0.0 | 96.2 | 94.7 | 0.0 | 95.1 | 100.0 | 0.0 | 87.5 | 100.0 | | 97.5 | 0.0 | 0.0 | 0.0 | 0.0 | 0.0 | 0.0 | 0.0 | 96.3 |
| Heavy trucks | 0 | 3 | 0 | 0 | 0 | 3 | 0 | 4 | 2 | 1 | 0 | 7 | 0 | 0 | 1 | 0 | 0 | 1 | 0 | 0 | 0 | 0 | 0 | 0 | 11 |

| | | | | | | | | | | | | | | | | | | | | | | | | | | | |
|---------------|--|-----|-----|-----|-----|-----|--|-----|-----|-----|-------|-----|--|-----|-----|------|-----|-----|--|-----|-----|-----|-----|-----|--|-----|-----|
| %Heavy trucks | | 0.0 | 2.8 | 0.0 | 0.0 | 2.7 | | 0.0 | 3.8 | 5.3 | 100.0 | 4.9 | | 0.0 | 0.0 | 12.5 | 0.0 | 2.5 | | 0.0 | 0.0 | 0.0 | 0.0 | 0.0 | | 0.0 | 3.7 |
|---------------|--|-----|-----|-----|-----|-----|--|-----|-----|-----|-------|-----|--|-----|-----|------|-----|-----|--|-----|-----|-----|-----|-----|--|-----|-----|

Project ID: 22-180056-003
 Location: Julian Baugh Rd & Cagle Mill Rd
 City: Lula

PEAK HOURS

Day: Wednesday
 Date: 3/30/2022

AM

| Start Time | Julian Baugh Rd Northbound | | | | | Julian Baugh Rd Southbound | | | | | Cagle Mill Rd Eastbound | | | | | Cagle Mill Rd Westbound | | | | | Int. Total |
|--|----------------------------|-------|-----|------|------------|----------------------------|-------|-------|------|------------|-------------------------|------|-----|------|------------|-------------------------|------|-----|------|------------|------------|
| | Left | Thru | Rgt | Utum | App. Total | Left | Thru | Rgt | Utum | App. Total | Left | Thru | Rgt | Utum | App. Total | Left | Thru | Rgt | Utum | App. Total | |
| Peak Hour Analysis from 07:00 AM - 10:00 AM | | | | | | | | | | | | | | | | | | | | | |
| Peak Hour for Entire Intersection Begins at 07:45 AM | | | | | | | | | | | | | | | | | | | | | |
| 7:45 AM | 0 | 2 | 0 | 0 | 2 | 0 | 2 | 0 | 0 | 2 | 1 | 0 | 0 | 0 | 1 | 0 | 0 | 0 | 0 | 0 | 5 |
| 8:00 AM | 1 | 3 | 0 | 0 | 4 | 0 | 0 | 0 | 0 | 0 | 0 | 0 | 0 | 0 | 0 | 0 | 0 | 0 | 0 | 0 | 4 |
| 8:15 AM | 0 | 2 | 0 | 0 | 2 | 0 | 2 | 1 | 0 | 3 | 1 | 0 | 0 | 0 | 1 | 0 | 0 | 0 | 0 | 0 | 6 |
| 8:30 AM | 0 | 3 | 0 | 0 | 3 | 0 | 1 | 2 | 0 | 3 | 2 | 0 | 0 | 0 | 2 | 0 | 0 | 0 | 0 | 0 | 8 |
| Total Volume | 1 | 10 | 0 | 0 | 11 | 0 | 5 | 3 | 0 | 8 | 4 | 0 | 0 | 0 | 4 | 0 | 0 | 0 | 0 | 0 | 23 |
| % App. Total | 9.1 | 90.9 | 0.0 | 0.0 | 100 | 0.0 | 62.5 | 37.5 | 0.0 | 100 | 100.0 | 0.0 | 0.0 | 0.0 | 100 | 0.0 | 0.0 | 0.0 | 0.0 | 0 | |
| PHF | 0.688 | | | | | 0.667 | | | | | 0.500 | | | | | 0.719 | | | | | |
| Cars, PU, Vans | 1 | 10 | 0 | 0 | 11 | 0 | 5 | 3 | 0 | 8 | 4 | 0 | 0 | 0 | 4 | 0 | 0 | 0 | 0 | 0 | 23 |
| % Cars, PU, Vans | 100.0 | 100.0 | 0.0 | 0.0 | 100.0 | 0.0 | 100.0 | 100.0 | 0.0 | 100.0 | 100.0 | 0.0 | 0.0 | 0.0 | 100.0 | 0.0 | 0.0 | 0.0 | 0.0 | 0.0 | 100.0 |
| Heavy trucks | 0 | 0 | 0 | 0 | 0 | 0 | 0 | 0 | 0 | 0 | 0 | 0 | 0 | 0 | 0 | 0 | 0 | 0 | 0 | 0 | 0 |
| %Heavy trucks | 0.0 | 0.0 | 0.0 | 0.0 | 0.0 | 0.0 | 0.0 | 0.0 | 0.0 | 0.0 | 0.0 | 0.0 | 0.0 | 0.0 | 0.0 | 0.0 | 0.0 | 0.0 | 0.0 | 0.0 | 0.0 |

NOON

| Start Time | Julian Baugh Rd Northbound | | | | | Julian Baugh Rd Southbound | | | | | Cagle Mill Rd Eastbound | | | | | Cagle Mill Rd Westbound | | | | | Int. Total |
|--|----------------------------|-------|-----|------|------------|----------------------------|-------|------|-------|------------|-------------------------|------|-------|------|------------|-------------------------|------|-----|------|------------|------------|
| | Left | Thru | Rgt | Utum | App. Total | Left | Thru | Rgt | Utum | App. Total | Left | Thru | Rgt | Utum | App. Total | Left | Thru | Rgt | Utum | App. Total | |
| Peak Hour Analysis from 10:00 AM - 02:00 PM | | | | | | | | | | | | | | | | | | | | | |
| Peak Hour for Entire Intersection Begins at 10:45 AM | | | | | | | | | | | | | | | | | | | | | |
| 10:45 AM | 0 | 5 | 0 | 0 | 5 | 0 | 2 | 0 | 1 | 3 | 0 | 0 | 0 | 0 | 0 | 0 | 0 | 0 | 0 | 0 | 8 |
| 11:00 AM | 0 | 2 | 0 | 0 | 2 | 0 | 1 | 1 | 0 | 2 | 0 | 0 | 2 | 0 | 2 | 0 | 0 | 0 | 0 | 0 | 6 |
| 11:15 AM | 0 | 7 | 0 | 0 | 7 | 0 | 2 | 2 | 0 | 4 | 2 | 0 | 0 | 0 | 2 | 0 | 0 | 0 | 0 | 0 | 13 |
| 11:30 AM | 0 | 2 | 0 | 0 | 2 | 0 | 1 | 0 | 0 | 1 | 1 | 0 | 1 | 0 | 2 | 0 | 0 | 0 | 0 | 0 | 5 |
| Total Volume | 0 | 16 | 0 | 0 | 16 | 0 | 6 | 3 | 1 | 10 | 3 | 0 | 3 | 0 | 6 | 0 | 0 | 0 | 0 | 0 | 32 |
| % App. Total | 0.0 | 100.0 | 0.0 | 0.0 | 100 | 0.0 | 60.0 | 30.0 | 10.0 | 100 | 50.0 | 0.0 | 50.0 | 0.0 | 100 | 0.0 | 0.0 | 0.0 | 0.0 | 0 | |
| PHF | 0.571 | | | | | 0.625 | | | | | 0.750 | | | | | 0.615 | | | | | |
| Cars, PU, Vans | 0 | 15 | 0 | 0 | 15 | 0 | 6 | 2 | 0 | 8 | 3 | 0 | 3 | 0 | 6 | 0 | 0 | 0 | 0 | 0 | 29 |
| % Cars, PU, Vans | 0.0 | 93.8 | 0.0 | 0.0 | 93.8 | 0.0 | 100.0 | 66.7 | 0.0 | 80.0 | 100.0 | 0.0 | 100.0 | 0.0 | 100.0 | 0.0 | 0.0 | 0.0 | 0.0 | 0.0 | 90.6 |
| Heavy trucks | 0 | 1 | 0 | 0 | 1 | 0 | 0 | 1 | 1 | 2 | 0 | 0 | 0 | 0 | 0 | 0 | 0 | 0 | 0 | 0 | 3 |
| %Heavy trucks | 0.0 | 6.3 | 0.0 | 0.0 | 6.3 | 0.0 | 0.0 | 33.3 | 100.0 | 20.0 | 0.0 | 0.0 | 0.0 | 0.0 | 0.0 | 0.0 | 0.0 | 0.0 | 0.0 | 0.0 | 9.4 |

PM

| Start Time | Julian Baugh Rd Northbound | | | | | Julian Baugh Rd Southbound | | | | | Cagle Mill Rd Eastbound | | | | | Cagle Mill Rd Westbound | | | | | Int. Total |
|--|----------------------------|-------|-----|------|------------|----------------------------|-------|-------|------|------------|-------------------------|------|-----|------|------------|-------------------------|------|-----|------|------------|------------|
| | Left | Thru | Rgt | Utum | App. Total | Left | Thru | Rgt | Utum | App. Total | Left | Thru | Rgt | Utum | App. Total | Left | Thru | Rgt | Utum | App. Total | |
| Peak Hour Analysis from 02:00 PM - 07:00 PM | | | | | | | | | | | | | | | | | | | | | |
| Peak Hour for Entire Intersection Begins at 05:15 PM | | | | | | | | | | | | | | | | | | | | | |
| 5:15 PM | 0 | 5 | 0 | 0 | 5 | 0 | 7 | 0 | 0 | 7 | 0 | 0 | 0 | 0 | 0 | 0 | 0 | 0 | 0 | 0 | 12 |
| 5:30 PM | 1 | 3 | 0 | 0 | 4 | 0 | 2 | 0 | 0 | 2 | 0 | 0 | 0 | 0 | 0 | 0 | 0 | 0 | 0 | 0 | 6 |
| 5:45 PM | 0 | 1 | 0 | 0 | 1 | 0 | 8 | 1 | 0 | 9 | 0 | 0 | 0 | 0 | 0 | 0 | 0 | 0 | 0 | 0 | 10 |
| 6:00 PM | 0 | 1 | 0 | 0 | 1 | 0 | 4 | 1 | 0 | 5 | 2 | 0 | 0 | 0 | 2 | 0 | 0 | 0 | 0 | 0 | 8 |
| Total Volume | 1 | 10 | 0 | 0 | 11 | 0 | 21 | 2 | 0 | 23 | 2 | 0 | 0 | 0 | 2 | 0 | 0 | 0 | 0 | 0 | 36 |
| % App. Total | 9.1 | 90.9 | 0.0 | 0.0 | 100 | 0.0 | 91.3 | 8.7 | 0.0 | 100 | 100.0 | 0.0 | 0.0 | 0.0 | 100 | 0.0 | 0.0 | 0.0 | 0.0 | 0 | |
| PHF | 0.550 | | | | | 0.639 | | | | | 0.250 | | | | | 0.750 | | | | | |
| Cars, PU, Vans | 1 | 10 | 0 | 0 | 11 | 0 | 21 | 2 | 0 | 23 | 2 | 0 | 0 | 0 | 2 | 0 | 0 | 0 | 0 | 0 | 36 |
| % Cars, PU, Vans | 100.0 | 100.0 | 0.0 | 0.0 | 100.0 | 0.0 | 100.0 | 100.0 | 0.0 | 100.0 | 100.0 | 0.0 | 0.0 | 0.0 | 100.0 | 0.0 | 0.0 | 0.0 | 0.0 | 0.0 | 100.0 |
| Heavy trucks | 0 | 0 | 0 | 0 | 0 | 0 | 0 | 0 | 0 | 0 | 0 | 0 | 0 | 0 | 0 | 0 | 0 | 0 | 0 | 0 | 0 |
| %Heavy trucks | 0.0 | 0.0 | 0.0 | 0.0 | 0.0 | 0.0 | 0.0 | 0.0 | 0.0 | 0.0 | 0.0 | 0.0 | 0.0 | 0.0 | 0.0 | 0.0 | 0.0 | 0.0 | 0.0 | 0.0 | 0.0 |

National Data & Surveying Services Intersection Turning Movement Count

Location: Cagle Mill Rd/Noah Martin Rd & Whitehall Rd
 City: Lula
 Control: 2-Way Stop (NB/SB)

Project ID: 22-180056-004
 Date: 3/30/2022

Data - Total

| NS/EW Streets: | Cagle Mill Rd/Noah Martin Rd | | | | Cagle Mill Rd/Noah Martin Rd | | | | Whitehall Rd | | | | Whitehall Rd | | | | | | | | |
|------------------|------------------------------|--------|--------|-------|------------------------------|--------|--------|-------|--------------|--------|--------|-------|--------------|--------|--------|-------|----|----|-------|----|-------|
| AM | NORTHBOUND | | | | SOUTHBOUND | | | | EASTBOUND | | | | WESTBOUND | | | | | | | | |
| | | 0 | 1 | 0 | 0 | | 0 | 1 | 0 | 0 | | 0 | 1 | 0 | 0 | | 0 | 1 | 0 | 0 | |
| | | NL | NT | NR | NU | | SL | ST | SR | SU | | EL | ET | ER | EU | | WL | WT | WR | WU | TOTAL |
| | 7:00 AM | 0 | 0 | 0 | 0 | 0 | 0 | 1 | 0 | 0 | 0 | 1 | 0 | 0 | 0 | 0 | 2 | 0 | 0 | 0 | 4 |
| | 7:15 AM | 0 | 0 | 1 | 0 | 0 | 2 | 1 | 0 | 0 | 0 | 3 | 0 | 0 | 0 | 0 | 1 | 0 | 0 | 0 | 8 |
| | 7:30 AM | 1 | 0 | 0 | 0 | 0 | 1 | 1 | 0 | 0 | 0 | 0 | 1 | 0 | 0 | 0 | 6 | 2 | 0 | 0 | 12 |
| | 7:45 AM | 0 | 0 | 0 | 0 | 1 | 2 | 0 | 0 | 0 | 0 | 0 | 0 | 0 | 0 | 0 | 4 | 0 | 0 | 0 | 7 |
| | 8:00 AM | 0 | 1 | 0 | 0 | 0 | 2 | 0 | 0 | 0 | 1 | 1 | 1 | 0 | 0 | 0 | 4 | 1 | 0 | 0 | 11 |
| | 8:15 AM | 1 | 0 | 0 | 0 | 1 | 1 | 1 | 0 | 0 | 0 | 0 | 1 | 0 | 0 | 0 | 2 | 0 | 0 | 0 | 7 |
| | 8:30 AM | 0 | 0 | 0 | 0 | 0 | 0 | 0 | 0 | 0 | 0 | 1 | 0 | 0 | 0 | 0 | 2 | 0 | 0 | 0 | 3 |
| 8:45 AM | 0 | 0 | 0 | 0 | 0 | 1 | 0 | 0 | 0 | 0 | 3 | 0 | 0 | 0 | 0 | 1 | 0 | 0 | 0 | 5 | |
| 9:00 AM | 0 | 0 | 1 | 0 | 0 | 1 | 0 | 0 | 0 | 0 | 0 | 0 | 0 | 0 | 0 | 0 | 0 | 0 | 0 | 2 | |
| 9:15 AM | 1 | 1 | 0 | 0 | 0 | 0 | 1 | 0 | 0 | 1 | 0 | 0 | 0 | 0 | 0 | 0 | 0 | 0 | 0 | 4 | |
| 9:30 AM | 0 | 0 | 0 | 0 | 0 | 1 | 0 | 0 | 0 | 0 | 1 | 0 | 0 | 0 | 0 | 1 | 0 | 0 | 0 | 3 | |
| 9:45 AM | 0 | 1 | 0 | 0 | 0 | 2 | 0 | 0 | 0 | 0 | 0 | 0 | 0 | 0 | 1 | 1 | 1 | 0 | 0 | 6 | |
| TOTAL VOLUMES : | NL | NT | NR | NU | SL | ST | SR | SU | EL | ET | ER | EU | WL | WT | WR | WU | | | TOTAL | | |
| APPROACH %'s : | 37.50% | 37.50% | 25.00% | 0.00% | 10.00% | 65.00% | 25.00% | 0.00% | 13.33% | 66.67% | 20.00% | 0.00% | 3.45% | 82.76% | 13.79% | 0.00% | | | 72 | | |
| PEAK HR : | 07:15 AM - 08:15 AM | | | | | | | | | | | | | | | | | | | | |
| PEAK HR VOL : | 1 | 1 | 0 | 0 | 1 | 7 | 2 | 0 | 1 | 4 | 2 | 0 | 0 | 15 | 3 | 0 | | | 38 | | |
| PEAK HR FACTOR : | 0.250 | 0.250 | 0.250 | 0.000 | 0.250 | 0.875 | 0.500 | 0.000 | 0.250 | 0.333 | 0.500 | 0.000 | 0.000 | 0.625 | 0.375 | 0.000 | | | 0.792 | | |
| | 0.750 | | | | 0.833 | | | | 0.583 | | | | 0.563 | | | | | | | | |
| NOON | NORTHBOUND | | | | SOUTHBOUND | | | | EASTBOUND | | | | WESTBOUND | | | | | | | | |
| | | 0 | 1 | 0 | 0 | | 0 | 1 | 0 | 0 | | 0 | 1 | 0 | 0 | | 0 | 1 | 0 | 0 | |
| | | NL | NT | NR | NU | | SL | ST | SR | SU | | EL | ET | ER | EU | | WL | WT | WR | WU | TOTAL |
| | 10:00 AM | 0 | 0 | 0 | 0 | 0 | 0 | 0 | 0 | 0 | 0 | 1 | 0 | 0 | 0 | 0 | 1 | 1 | 0 | 0 | 3 |
| | 10:15 AM | 0 | 0 | 0 | 0 | 0 | 2 | 1 | 0 | 0 | 0 | 1 | 0 | 0 | 0 | 0 | 0 | 0 | 0 | 0 | 4 |
| | 10:30 AM | 1 | 1 | 0 | 0 | 0 | 0 | 0 | 0 | 0 | 0 | 2 | 1 | 0 | 0 | 1 | 1 | 0 | 0 | 0 | 7 |
| | 10:45 AM | 1 | 0 | 0 | 0 | 0 | 1 | 0 | 0 | 0 | 1 | 0 | 0 | 0 | 0 | 1 | 1 | 0 | 0 | 0 | 5 |
| | 11:00 AM | 1 | 0 | 0 | 0 | 0 | 0 | 0 | 1 | 0 | 0 | 1 | 0 | 0 | 0 | 2 | 1 | 0 | 0 | 0 | 6 |
| | 11:15 AM | 0 | 0 | 0 | 0 | 0 | 0 | 0 | 0 | 0 | 0 | 0 | 1 | 0 | 0 | 0 | 0 | 0 | 0 | 0 | 1 |
| | 11:30 AM | 1 | 0 | 1 | 0 | 0 | 1 | 0 | 0 | 0 | 1 | 4 | 1 | 0 | 0 | 0 | 1 | 1 | 0 | 0 | 11 |
| 11:45 AM | 2 | 0 | 0 | 0 | 0 | 0 | 1 | 0 | 0 | 0 | 0 | 4 | 0 | 0 | 0 | 1 | 0 | 0 | 0 | 8 | |
| 12:00 PM | 0 | 1 | 1 | 0 | 0 | 1 | 0 | 0 | 0 | 0 | 1 | 1 | 0 | 0 | 1 | 2 | 0 | 0 | 0 | 8 | |
| 12:15 PM | 0 | 0 | 2 | 0 | 0 | 0 | 1 | 0 | 0 | 0 | 1 | 0 | 0 | 0 | 0 | 2 | 0 | 0 | 0 | 6 | |
| 12:30 PM | 0 | 0 | 0 | 0 | 0 | 1 | 0 | 0 | 0 | 0 | 2 | 0 | 0 | 0 | 0 | 2 | 0 | 0 | 0 | 5 | |
| 12:45 PM | 0 | 0 | 1 | 0 | 0 | 3 | 0 | 0 | 0 | 0 | 0 | 2 | 0 | 0 | 0 | 2 | 0 | 0 | 0 | 8 | |
| 1:00 PM | 0 | 0 | 0 | 0 | 0 | 0 | 0 | 0 | 0 | 0 | 1 | 1 | 0 | 0 | 0 | 0 | 0 | 0 | 0 | 2 | |
| 1:15 PM | 2 | 0 | 0 | 0 | 0 | 0 | 0 | 0 | 0 | 2 | 2 | 0 | 0 | 0 | 0 | 0 | 0 | 0 | 0 | 6 | |
| 1:30 PM | 1 | 0 | 1 | 0 | 1 | 0 | 0 | 0 | 0 | 0 | 1 | 1 | 0 | 0 | 1 | 2 | 0 | 0 | 0 | 8 | |
| 1:45 PM | 1 | 1 | 0 | 0 | 0 | 1 | 0 | 0 | 0 | 0 | 1 | 0 | 0 | 0 | 1 | 0 | 0 | 0 | 0 | 5 | |
| TOTAL VOLUMES : | NL | NT | NR | NU | SL | ST | SR | SU | EL | ET | ER | EU | WL | WT | WR | WU | | | TOTAL | | |
| APPROACH %'s : | 52.63% | 15.79% | 31.58% | 0.00% | 6.67% | 66.67% | 20.00% | 6.67% | 11.76% | 52.94% | 35.29% | 0.00% | 28.00% | 64.00% | 8.00% | 0.00% | | | 93 | | |
| PEAK HR : | 11:30 AM - 12:30 PM | | | | | | | | | | | | | | | | | | | | |
| PEAK HR VOL : | 3 | 1 | 4 | 0 | 0 | 2 | 2 | 0 | 1 | 6 | 6 | 0 | 1 | 6 | 1 | 0 | | | 33 | | |
| PEAK HR FACTOR : | 0.375 | 0.250 | 0.500 | 0.000 | 0.000 | 0.500 | 0.500 | 0.000 | 0.250 | 0.375 | 0.375 | 0.000 | 0.250 | 0.750 | 0.250 | 0.000 | | | 0.750 | | |
| | 1.000 | | | | 1.000 | | | | 0.542 | | | | 0.667 | | | | | | | | |
| PM | NORTHBOUND | | | | SOUTHBOUND | | | | EASTBOUND | | | | WESTBOUND | | | | | | | | |
| | | 0 | 1 | 0 | 0 | | 0 | 1 | 0 | 0 | | 0 | 1 | 0 | 0 | | 0 | 1 | 0 | 0 | |
| | | NL | NT | NR | NU | | SL | ST | SR | SU | | EL | ET | ER | EU | | WL | WT | WR | WU | TOTAL |
| | 2:00 PM | 0 | 0 | 1 | 0 | 0 | 0 | 0 | 0 | 0 | 0 | 2 | 0 | 0 | 0 | 1 | 1 | 0 | 0 | 0 | 5 |
| | 2:15 PM | 0 | 1 | 3 | 0 | 1 | 0 | 0 | | | | | | | | | | | | | |

National Data & Surveying Services Intersection Turning Movement Count

Location: Cagle Mill Rd/Noah Martin Rd & Whitehall Rd
 City: Lula
 Control: 2-Way Stop (NB/SB)

Project ID: 22-180056-004
 Date: 3/30/2022

Data - Cars

| NS/EW Streets: | Cagle Mill Rd/Noah Martin Rd | | | | Cagle Mill Rd/Noah Martin Rd | | | | Whitehall Rd | | | | Whitehall Rd | | | | |
|-----------------|------------------------------|--------|--------|-------|------------------------------|--------|--------|-------|--------------|--------|--------|-------|--------------|--------|--------|-------|-------|
| AM | NORTHBOUND | | | | SOUTHBOUND | | | | EASTBOUND | | | | WESTBOUND | | | | |
| | NL | NT | NR | NU | SL | ST | SR | SU | EL | ET | ER | EU | WL | WT | WR | WU | TOTAL |
| 7:00 AM | 0 | 1 | 0 | 0 | 0 | 1 | 0 | 0 | 0 | 1 | 0 | 0 | 0 | 2 | 0 | 0 | 4 |
| 7:15 AM | 0 | 0 | 0 | 0 | 0 | 2 | 1 | 0 | 0 | 3 | 0 | 0 | 0 | 1 | 0 | 0 | 7 |
| 7:30 AM | 1 | 0 | 0 | 0 | 0 | 1 | 0 | 0 | 0 | 0 | 0 | 0 | 0 | 6 | 1 | 0 | 9 |
| 7:45 AM | 0 | 0 | 0 | 0 | 1 | 2 | 0 | 0 | 0 | 0 | 0 | 0 | 0 | 4 | 0 | 0 | 7 |
| 8:00 AM | 0 | 1 | 0 | 0 | 0 | 2 | 0 | 0 | 1 | 1 | 1 | 0 | 0 | 4 | 1 | 0 | 11 |
| 8:15 AM | 1 | 0 | 0 | 0 | 1 | 1 | 1 | 0 | 0 | 0 | 1 | 0 | 0 | 2 | 0 | 0 | 7 |
| 8:30 AM | 0 | 0 | 0 | 0 | 0 | 0 | 0 | 0 | 0 | 1 | 0 | 0 | 0 | 2 | 0 | 0 | 3 |
| 8:45 AM | 0 | 0 | 0 | 0 | 0 | 1 | 0 | 0 | 0 | 3 | 0 | 0 | 0 | 1 | 0 | 0 | 5 |
| 9:00 AM | 0 | 0 | 1 | 0 | 0 | 1 | 0 | 0 | 0 | 0 | 0 | 0 | 0 | 0 | 0 | 0 | 2 |
| 9:15 AM | 1 | 1 | 0 | 0 | 0 | 0 | 1 | 0 | 1 | 1 | 0 | 0 | 0 | 0 | 0 | 0 | 4 |
| 9:30 AM | 0 | 0 | 0 | 0 | 0 | 1 | 0 | 0 | 0 | 1 | 0 | 0 | 0 | 1 | 0 | 0 | 3 |
| 9:45 AM | 0 | 1 | 0 | 0 | 0 | 2 | 0 | 0 | 0 | 0 | 0 | 0 | 1 | 1 | 1 | 0 | 6 |
| TOTAL VOLUMES: | NL | NT | NR | NU | SL | ST | SR | SU | EL | ET | ER | EU | WL | WT | WR | WU | TOTAL |
| APPROACH %'s: | 42.86% | 42.86% | 14.29% | 0.00% | 10.53% | 68.42% | 21.05% | 0.00% | 14.29% | 71.43% | 14.29% | 0.00% | 3.57% | 85.71% | 10.71% | 0.00% | 68 |
| PEAK HR: | 07:15 AM - 08:15 AM | | | | | | | | | | | | | | | | TOTAL |
| PEAK HR VOL: | 1 | 1 | 0 | 0 | 1 | 7 | 1 | 0 | 1 | 4 | 1 | 0 | 0 | 15 | 2 | 0 | 34 |
| PEAK HR FACTOR: | 0.250 | 0.250 | 0.000 | 0.000 | 0.250 | 0.875 | 0.250 | 0.000 | 0.250 | 0.333 | 0.250 | 0.000 | 0.000 | 0.625 | 0.500 | 0.000 | 0.773 |
| | | | 0.500 | | | 0.750 | | | | 0.500 | | | | 0.607 | | | |
| NOON | NORTHBOUND | | | | SOUTHBOUND | | | | EASTBOUND | | | | WESTBOUND | | | | |
| | NL | NT | NR | NU | SL | ST | SR | SU | EL | ET | ER | EU | WL | WT | WR | WU | TOTAL |
| 10:00 AM | 0 | 0 | 0 | 0 | 0 | 0 | 0 | 0 | 0 | 1 | 0 | 0 | 0 | 1 | 1 | 0 | 3 |
| 10:15 AM | 0 | 0 | 0 | 0 | 0 | 2 | 0 | 0 | 0 | 0 | 0 | 0 | 0 | 0 | 0 | 0 | 2 |
| 10:30 AM | 1 | 1 | 0 | 0 | 0 | 0 | 0 | 0 | 0 | 2 | 1 | 0 | 0 | 1 | 0 | 0 | 6 |
| 10:45 AM | 1 | 0 | 0 | 0 | 0 | 1 | 0 | 0 | 1 | 0 | 0 | 0 | 1 | 1 | 0 | 0 | 5 |
| 11:00 AM | 1 | 0 | 0 | 0 | 0 | 0 | 0 | 1 | 0 | 1 | 0 | 0 | 2 | 1 | 0 | 0 | 6 |
| 11:15 AM | 0 | 0 | 0 | 0 | 0 | 0 | 0 | 0 | 0 | 0 | 1 | 0 | 0 | 0 | 0 | 0 | 1 |
| 11:30 AM | 1 | 0 | 1 | 0 | 0 | 1 | 0 | 0 | 1 | 4 | 0 | 0 | 0 | 1 | 1 | 0 | 10 |
| 11:45 AM | 2 | 0 | 0 | 0 | 0 | 0 | 1 | 0 | 0 | 4 | 0 | 4 | 0 | 1 | 0 | 0 | 8 |
| 12:00 PM | 0 | 1 | 1 | 0 | 0 | 1 | 0 | 0 | 0 | 1 | 1 | 0 | 1 | 2 | 0 | 0 | 8 |
| 12:15 PM | 0 | 0 | 2 | 0 | 0 | 0 | 0 | 0 | 0 | 0 | 0 | 0 | 0 | 2 | 0 | 0 | 4 |
| 12:30 PM | 0 | 0 | 0 | 0 | 0 | 1 | 0 | 0 | 0 | 2 | 0 | 0 | 0 | 2 | 0 | 0 | 5 |
| 12:45 PM | 0 | 0 | 1 | 0 | 0 | 3 | 0 | 0 | 0 | 0 | 2 | 0 | 0 | 2 | 0 | 0 | 8 |
| 1:00 PM | 0 | 0 | 0 | 0 | 0 | 0 | 0 | 0 | 0 | 1 | 1 | 0 | 0 | 0 | 0 | 0 | 2 |
| 1:15 PM | 2 | 0 | 0 | 0 | 0 | 0 | 0 | 0 | 2 | 2 | 0 | 0 | 0 | 0 | 0 | 0 | 6 |
| 1:30 PM | 1 | 0 | 1 | 0 | 1 | 0 | 0 | 0 | 0 | 1 | 1 | 0 | 1 | 2 | 0 | 0 | 8 |
| 1:45 PM | 1 | 1 | 0 | 0 | 0 | 1 | 0 | 0 | 0 | 1 | 0 | 0 | 1 | 0 | 0 | 0 | 5 |
| TOTAL VOLUMES: | NL | NT | NR | NU | SL | ST | SR | SU | EL | ET | ER | EU | WL | WT | WR | WU | TOTAL |
| APPROACH %'s: | 52.63% | 15.79% | 31.58% | 0.00% | 7.69% | 76.92% | 7.69% | 7.69% | 12.90% | 51.61% | 35.48% | 0.00% | 25.00% | 66.67% | 8.33% | 0.00% | 87 |
| PEAK HR: | 11:30 AM - 12:30 PM | | | | | | | | | | | | | | | | TOTAL |
| PEAK HR VOL: | 3 | 1 | 4 | 0 | 0 | 2 | 1 | 0 | 1 | 5 | 5 | 0 | 1 | 6 | 1 | 0 | 30 |
| PEAK HR FACTOR: | 0.375 | 0.250 | 0.500 | 0.000 | 0.000 | 0.500 | 0.250 | 0.000 | 0.250 | 0.313 | 0.313 | 0.000 | 0.250 | 0.750 | 0.250 | 0.000 | 0.750 |
| | | | 1.000 | | | 0.750 | | | | 0.550 | | | | 0.667 | | | |
| PM | NORTHBOUND | | | | SOUTHBOUND | | | | EASTBOUND | | | | WESTBOUND | | | | |
| | NL | NT | NR | NU | SL | ST | SR | SU | EL | ET | ER | EU | WL | WT | WR | WU | TOTAL |
| 2:00 PM | 0 | 0 | 1 | 0 | 0 | 0 | 0 | 0 | 0 | 2 | 0 | 0 | 1 | 1 | 0 | 0 | 5 |
| 2:15 PM | 0 | 1 | 3 | 0 | 1 | 0 | 0 | 0 | 0 | 1 | 1 | 0 | 0 | 1 | 0 | 0 | 8 |
| 2:30 PM | 0 | 1 | 2 | 0 | 0 | 0 | 0 | 0 | 0 | 1 | 0 | 0 | 1 | 3 | 1 | 0 | 9 |
| 2:45 PM | 0 | 0 | 0 | 0 | 1 | 2 | 0 | 0 | 1 | 1 | 1 | 0 | 0 | 2 | 1 | 0 | 9 |
| 3:00 PM | 0 | 1 | 0 | 0 | 0 | 0 | 0 | 0 | 0 | 0 | 0 | 0 | 0 | 0 | 0 | 0 | 1 |
| 3:15 PM | 1 | 2 | 1 | 0 | 0 | 0 | 0 | 0 | 0 | 3 | 0 | 0 | 0 | 0 | 0 | 0 | 7 |
| 3:30 PM | 0 | 0 | 1 | 0 | 0 | 1 | 0 | 0 | 0 | 4 | 0 | 0 | 0 | 3 | 0 | 0 | 9 |
| 3:45 PM | 1 | 0 | 1 | 0 | 0 | 0 | 1 | 0 | 0 | 0 | 1 | 0 | 0 | 0 | 0 | 0 | 4 |
| 4:00 PM | 2 | 0 | 1 | 0 | 1 | 1 | 0 | 0 | 1 | 1 | 2 | 0 | 0 | 4 | 0 | 0 | 13 |
| 4:15 PM | 0 | 0 | 3 | 0 | 1 | 0 | 1 | 0 | 0 | 2 | 1 | 0 | 0 | 2 | 0 | 0 | 10 |
| 4:30 PM | 1 | 1 | 0 | 0 | 0 | 0 | 0 | 0 | 1 | 5 | 2 | 0 | 0 | 0 | 4 | 0 | 14 |
| 4:45 PM | 2 | 1 | 0 | 0 | 0 | 0 | 0 | 0 | 1 | 3 | 0 | 0 | 2 | 0 | 0 | 0 | 9 |
| 5:00 PM | 2 | 0 | 1 | 1 | 1 | 2 | 0 | 0 | 2 | 3 | 0 | 0 | 1 | 2 | 0 | 0 | 15 |
| 5:15 PM | 0 | 1 | 2 | 0 | 0 | 0 | 0 | 0 | 0 | 3 | 1 | 0 | 1 | 1 | 0 | 0 | 9 |
| 5:30 PM | 5 | 1 | 2 | 0 | 0 | 0 | 1 | 0 | 0 | 4 | 1 | 1 | 1 | 3 | 0 | 0 | 19 |
| 5:45 PM | 0 | 0 | 1 | 0 | 0 | 0 | 0 | 0 | 1 | 4 | 3 | 0 | 3 | 2 | 0 | 0 | 14 |
| 6:00 PM | 1 | 1 | 1 | 0 | 1 | 0 | 0 | 0 | 1 | 1 | 1 | 0 | 0 | 1 | 0 | 0 | 8 |
| 6:15 PM | 2 | 1 | 0 | 0 | 0 | 0 | 1 | 0 | 0 | 3 | 2 | 0 | 0 | 2 | 0 | 0 | 11 |
| 6:30 PM | 2 | 1 | 1 | 0 | 0 | 1 | 0 | 0 | 0 | 3 | 1 | 0 | 4 | 0 | 0 | 1 | 14 |
| 6:45 PM | 0 | 0 | 3 | 0 | 0 | 1 | 0 | 0 | 1 | 4 | 0 | 0 | 0 | 1 | 1 | 0 | 11 |
| TOTAL VOLUMES: | NL | NT | NR | NU | SL | ST | SR | SU | EL | ET | ER | EU | WL | WT | WR | WU | TOTAL |
| APPROACH %'s: | 33.93% | 21.43% | 42.86% | 1.79% | 33.33% | 44.44% | 22.22% | 0.00% | 12.00% | 64.00% | 22.67% | 1.33% | 28.00% | 56.00% | 14.00% | 2.00% | 199 |
| PEAK HR: | 05:00 PM - 06:00 PM | | | | | | | | | | | | | | | | TOTAL |
| PEAK HR VOL: | 7 | 2 | 6 | 1 | 1 | 2 | 1 | 0 | 3 | 14 | 5 | 1 | 6 | 8 | 0 | 0 | 57 |
| PEAK HR FACTOR: | 0.350 | 0.500 | 0.750 | 0.250 | 0.250 | 0.250 | 0.250 | 0.000 | 0.375 | 0.875 | 0.417 | 0.250 | 0.500 | 0.667 | 0.000 | 0.000 | 0.750 |
| | | | 0.500 | | | 0.333 | | | | 0.719 | | | | 0.700 | | | |

National Data & Surveying Services Intersection Turning Movement Count

Location: Cagle Mill Rd/Noah Martin Rd & Whitehall Rd
 City: Lula
 Control: 2-Way Stop (NB/SB)

Project ID: 22-180056-004
 Date: 3/30/2022

Data - HT

| NS/EW Streets: | Cagle Mill Rd/Noah Martin Rd | | | | Cagle Mill Rd/Noah Martin Rd | | | | Whitehall Rd | | | | Whitehall Rd | | | | | |
|------------------|------------------------------|-------|---------|-------|------------------------------|-------|---------|-------|--------------|--------|---------|-------|--------------|--------|---------|-------|-------|---|
| AM | NORTHBOUND | | | | SOUTHBOUND | | | | EASTBOUND | | | | WESTBOUND | | | | TOTAL | |
| | NL | NT | NR | NU | SL | ST | SR | SU | EL | ET | ER | EU | WL | WT | WR | WU | | |
| 7:00 AM | 0 | 0 | 0 | 0 | 0 | 0 | 0 | 0 | 0 | 0 | 0 | 0 | 0 | 0 | 0 | 0 | 0 | 0 |
| 7:15 AM | 0 | 1 | 0 | 0 | 0 | 1 | 0 | 0 | 0 | 0 | 0 | 0 | 0 | 0 | 0 | 0 | 0 | 1 |
| 7:30 AM | 0 | 0 | 0 | 0 | 0 | 0 | 1 | 0 | 0 | 0 | 0 | 1 | 0 | 0 | 1 | 0 | 0 | 3 |
| 7:45 AM | 0 | 0 | 0 | 0 | 0 | 0 | 0 | 0 | 0 | 0 | 0 | 0 | 0 | 0 | 0 | 0 | 0 | 0 |
| 8:00 AM | 0 | 0 | 0 | 0 | 0 | 0 | 0 | 0 | 0 | 0 | 0 | 0 | 0 | 0 | 0 | 0 | 0 | 0 |
| 8:15 AM | 0 | 0 | 0 | 0 | 0 | 0 | 0 | 0 | 0 | 0 | 0 | 0 | 0 | 0 | 0 | 0 | 0 | 0 |
| 8:30 AM | 0 | 0 | 0 | 0 | 0 | 0 | 0 | 0 | 0 | 0 | 0 | 0 | 0 | 0 | 0 | 0 | 0 | 0 |
| 8:45 AM | 0 | 0 | 0 | 0 | 0 | 0 | 0 | 0 | 0 | 0 | 0 | 0 | 0 | 0 | 0 | 0 | 0 | 0 |
| 9:00 AM | 0 | 0 | 0 | 0 | 0 | 0 | 0 | 0 | 0 | 0 | 0 | 0 | 0 | 0 | 0 | 0 | 0 | 0 |
| 9:15 AM | 0 | 0 | 0 | 0 | 0 | 0 | 0 | 0 | 0 | 0 | 0 | 0 | 0 | 0 | 0 | 0 | 0 | 0 |
| 9:30 AM | 0 | 0 | 0 | 0 | 0 | 0 | 0 | 0 | 0 | 0 | 0 | 0 | 0 | 0 | 0 | 0 | 0 | 0 |
| 9:45 AM | 0 | 0 | 0 | 0 | 0 | 0 | 0 | 0 | 0 | 0 | 0 | 0 | 0 | 0 | 0 | 0 | 0 | 0 |
| TOTAL VOLUMES : | NL | NT | NR | NU | SL | ST | SR | SU | EL | ET | ER | EU | WL | WT | WR | WU | TOTAL | |
| APPROACH %'s : | 0 | 0 | 1 | 0 | 0 | 0 | 1 | 0 | 0 | 0 | 1 | 0 | 0 | 0 | 1 | 0 | 4 | |
| APPROACH %'s : | 0.00% | 0.00% | 100.00% | 0.00% | 0.00% | 0.00% | 100.00% | 0.00% | 0.00% | 0.00% | 100.00% | 0.00% | 0.00% | 0.00% | 100.00% | 0.00% | | |
| PEAK HR : | 07:15 AM - 08:15 AM | | | | | | | | | | | | | | | | TOTAL | |
| PEAK HR VOL : | 0 | 0 | 1 | 0 | 0 | 0 | 1 | 0 | 0 | 0 | 1 | 0 | 0 | 0 | 1 | 0 | 4 | |
| PEAK HR FACTOR : | 0.000 | 0.000 | 0.250 | 0.000 | 0.000 | 0.000 | 0.250 | 0.000 | 0.000 | 0.000 | 0.250 | 0.000 | 0.000 | 0.000 | 0.250 | 0.000 | 0.333 | |
| | 0.250 | | | | 0.250 | | | | 0.250 | | | | 0.250 | | | | | |
| NOON | NORTHBOUND | | | | SOUTHBOUND | | | | EASTBOUND | | | | WESTBOUND | | | | TOTAL | |
| | NL | NT | NR | NU | SL | ST | SR | SU | EL | ET | ER | EU | WL | WT | WR | WU | | |
| 10:00 AM | 0 | 0 | 0 | 0 | 0 | 0 | 0 | 0 | 0 | 0 | 0 | 0 | 0 | 0 | 0 | 0 | 0 | 0 |
| 10:15 AM | 0 | 0 | 0 | 0 | 0 | 0 | 1 | 0 | 0 | 0 | 1 | 0 | 0 | 0 | 0 | 0 | 0 | 2 |
| 10:30 AM | 0 | 0 | 0 | 0 | 0 | 0 | 0 | 0 | 0 | 0 | 0 | 0 | 1 | 0 | 0 | 0 | 0 | 1 |
| 10:45 AM | 0 | 0 | 0 | 0 | 0 | 0 | 0 | 0 | 0 | 0 | 0 | 0 | 0 | 0 | 0 | 0 | 0 | 0 |
| 11:00 AM | 0 | 0 | 0 | 0 | 0 | 0 | 0 | 0 | 0 | 0 | 0 | 0 | 0 | 0 | 0 | 0 | 0 | 0 |
| 11:15 AM | 0 | 0 | 0 | 0 | 0 | 0 | 0 | 0 | 0 | 0 | 0 | 0 | 0 | 0 | 0 | 0 | 0 | 0 |
| 11:30 AM | 0 | 0 | 0 | 0 | 0 | 0 | 0 | 0 | 0 | 0 | 1 | 0 | 0 | 0 | 0 | 0 | 0 | 1 |
| 11:45 AM | 0 | 0 | 0 | 0 | 0 | 0 | 0 | 0 | 0 | 0 | 0 | 0 | 0 | 0 | 0 | 0 | 0 | 0 |
| 12:00 PM | 0 | 0 | 0 | 0 | 0 | 0 | 0 | 0 | 0 | 0 | 0 | 0 | 0 | 0 | 0 | 0 | 0 | 0 |
| 12:15 PM | 0 | 0 | 0 | 0 | 0 | 0 | 1 | 0 | 0 | 0 | 1 | 0 | 0 | 0 | 0 | 0 | 0 | 2 |
| 12:30 PM | 0 | 0 | 0 | 0 | 0 | 0 | 0 | 0 | 0 | 0 | 0 | 0 | 0 | 0 | 0 | 0 | 0 | 0 |
| 12:45 PM | 0 | 0 | 0 | 0 | 0 | 0 | 0 | 0 | 0 | 0 | 0 | 0 | 0 | 0 | 0 | 0 | 0 | 0 |
| 1:00 PM | 0 | 0 | 0 | 0 | 0 | 0 | 0 | 0 | 0 | 0 | 0 | 0 | 0 | 0 | 0 | 0 | 0 | 0 |
| 1:15 PM | 0 | 0 | 0 | 0 | 0 | 0 | 0 | 0 | 0 | 0 | 0 | 0 | 0 | 0 | 0 | 0 | 0 | 0 |
| 1:30 PM | 0 | 0 | 0 | 0 | 0 | 0 | 0 | 0 | 0 | 0 | 0 | 0 | 0 | 0 | 0 | 0 | 0 | 0 |
| 1:45 PM | 0 | 0 | 0 | 0 | 0 | 0 | 0 | 0 | 0 | 0 | 0 | 0 | 0 | 0 | 0 | 0 | 0 | 0 |
| TOTAL VOLUMES : | NL | NT | NR | NU | SL | ST | SR | SU | EL | ET | ER | EU | WL | WT | WR | WU | TOTAL | |
| APPROACH %'s : | 0 | 0 | 0 | 0 | 0 | 0 | 2 | 0 | 0 | 2 | 1 | 0 | 1 | 0 | 0 | 0 | 6 | |
| APPROACH %'s : | 0.00% | 0.00% | 0.00% | 0.00% | 0.00% | 0.00% | 100.00% | 0.00% | 0.00% | 66.67% | 33.33% | 0.00% | 100.00% | 0.00% | 0.00% | 0.00% | | |
| PEAK HR : | 11:30 AM - 12:30 PM | | | | | | | | | | | | | | | | TOTAL | |
| PEAK HR VOL : | 0 | 0 | 0 | 0 | 0 | 0 | 1 | 0 | 0 | 1 | 1 | 0 | 0 | 0 | 0 | 0 | 3 | |
| PEAK HR FACTOR : | 0.000 | 0.000 | 0.000 | 0.000 | 0.000 | 0.000 | 0.250 | 0.000 | 0.000 | 0.250 | 0.250 | 0.000 | 0.000 | 0.000 | 0.000 | 0.000 | 0.375 | |
| | 0.250 | | | | 0.250 | | | | 0.500 | | | | 0.250 | | | | | |
| PM | NORTHBOUND | | | | SOUTHBOUND | | | | EASTBOUND | | | | WESTBOUND | | | | TOTAL | |
| | NL | NT | NR | NU | SL | ST | SR | SU | EL | ET | ER | EU | WL | WT | WR | WU | | |
| 2:00 PM | 0 | 1 | 0 | 0 | 0 | 1 | 0 | 0 | 0 | 0 | 0 | 0 | 0 | 0 | 0 | 0 | 0 | 0 |
| 2:15 PM | 0 | 0 | 0 | 0 | 0 | 0 | 0 | 0 | 0 | 0 | 0 | 0 | 0 | 0 | 0 | 0 | 0 | 0 |
| 2:30 PM | 0 | 0 | 1 | 0 | 0 | 0 | 0 | 0 | 0 | 0 | 0 | 0 | 0 | 0 | 0 | 0 | 0 | 1 |
| 2:45 PM | 0 | 0 | 0 | 0 | 0 | 0 | 0 | 0 | 0 | 0 | 0 | 0 | 0 | 1 | 0 | 0 | 0 | 1 |
| 3:00 PM | 0 | 0 | 0 | 0 | 0 | 0 | 0 | 0 | 0 | 0 | 0 | 0 | 0 | 0 | 0 | 0 | 0 | 0 |
| 3:15 PM | 0 | 0 | 1 | 0 | 0 | 0 | 0 | 0 | 0 | 0 | 0 | 0 | 0 | 0 | 0 | 0 | 0 | 1 |
| 3:30 PM | 0 | 0 | 0 | 0 | 0 | 0 | 0 | 0 | 0 | 0 | 0 | 0 | 0 | 0 | 0 | 0 | 0 | 0 |
| 3:45 PM | 0 | 0 | 0 | 0 | 0 | 0 | 0 | 0 | 0 | 0 | 0 | 0 | 0 | 0 | 0 | 0 | 0 | 0 |
| 4:00 PM | 0 | 0 | 0 | 0 | 0 | 0 | 1 | 0 | 0 | 0 | 1 | 0 | 0 | 0 | 1 | 0 | 0 | 3 |
| 4:15 PM | 0 | 0 | 0 | 0 | 0 | 0 | 0 | 0 | 0 | 0 | 0 | 0 | 0 | 0 | 0 | 0 | 0 | 0 |
| 4:30 PM | 0 | 0 | 0 | 0 | 0 | 0 | 0 | 0 | 0 | 0 | 0 | 0 | 0 | 0 | 0 | 0 | 0 | 0 |
| 4:45 PM | 0 | 0 | 0 | 0 | 0 | 0 | 0 | 0 | 0 | 0 | 0 | 0 | 0 | 0 | 0 | 0 | 0 | 0 |
| 5:00 PM | 0 | 0 | 0 | 0 | 0 | 0 | 0 | 0 | 0 | 0 | 0 | 0 | 0 | 0 | 0 | 0 | 0 | 0 |
| 5:15 PM | 0 | 0 | 0 | 0 | 0 | 0 | 0 | 0 | 0 | 0 | 0 | 0 | 0 | 0 | 0 | 0 | 0 | 0 |
| 5:30 PM | 0 | 0 | 0 | 0 | 0 | 0 | 0 | 0 | 0 | 0 | 0 | 0 | 0 | 0 | 0 | 0 | 0 | 0 |
| 5:45 PM | 0 | 0 | 1 | 0 | 0 | 0 | 0 | 0 | 0 | 0 | 0 | 1 | 0 | 0 | 0 | 0 | 0 | 2 |
| 6:00 PM | 0 | 0 | 0 | 0 | 0 | 0 | 0 | 0 | 0 | 0 | 0 | 0 | 0 | 0 | 0 | 0 | 0 | 0 |
| 6:15 PM | 0 | 0 | 0 | 0 | 0 | 0 | 0 | 0 | 0 | 0 | 0 | 0 | 0 | 0 | 0 | 0 | 0 | 0 |
| 6:30 PM | 0 | 0 | 0 | 0 | 0 | 0 | 0 | 0 | 0 | 0 | 1 | 0 | 0 | 0 | 0 | 0 | 0 | 1 |
| 6:45 PM | 0 | 0 | 0 | 0 | 0 | 0 | 0 | 0 | 0 | 0 | 2 | 0 | 0 | 0 | 0 | 0 | 0 | 2 |
| TOTAL VOLUMES : | NL | NT | NR | NU | SL | ST | SR | SU | EL | ET | ER | EU | WL | WT | WR | WU | TOTAL | |
| APPROACH %'s : | 0 | 0 | 3 | 0 | 0 | 0 | 1 | 0 | 0 | 1 | 3 | 0 | 1 | 1 | 1 | 0 | 11 | |
| APPROACH %'s : | 0.00% | 0.00% | 100.00% | 0.00% | 0.00% | 0.00% | 100.00% | 0.00% | 0.00% | 25.00% | 75.00% | 0.00% | 33.33% | 33.33% | 33.33% | 0.00% | | |
| PEAK HR : | 05:00 PM - 06:00 PM | | | | | | | | | | | | | | | | TOTAL | |
| PEAK HR VOL : | 0 | 0 | 1 | 0 | 0 | 0 | 0 | 0 | 0 | 0 | 0 | 0 | 1 | 0 | 0 | 0 | 2 | |
| PEAK HR FACTOR : | 0.000 | 0.000 | 0.250 | 0.000 | 0.000 | 0.000 | 0.000 | 0.000 | 0.000 | 0.000 | 0.000 | 0.000 | 0.250 | 0.000 | 0.000 | 0.000 | 0.250 | |
| | 0.250 | | | | 0.250 | | | | 0.250 | | | | 0.250 | | | | | |

National Data & Surveying Services Intersection Turning Movement Count

Location: Cagle Mill Rd/Noah Martin Rd & Whitehall Rd
 City: Lula

Project ID: 22-180056-004
 Date: 3/30/2022

Data - Pedestrians (Crosswalks)

| NS/EW Streets: | Cagle Mill Rd/Noah Martin Rd | | Cagle Mill Rd/Noah Martin Rd | | Whitehall Rd | | Whitehall Rd | | TOTAL |
|------------------|------------------------------|----|------------------------------|----|--------------|----|--------------|----|-------|
| | NORTH LEG | | SOUTH LEG | | EAST LEG | | WEST LEG | | |
| | EB | WB | EB | WB | NB | SB | NB | SB | |
| AM | | | | | | | | | |
| 7:00 AM | 0 | 0 | 0 | 0 | 0 | 0 | 0 | 0 | 0 |
| 7:15 AM | 0 | 0 | 0 | 0 | 0 | 0 | 0 | 0 | 0 |
| 7:30 AM | 0 | 0 | 0 | 0 | 0 | 0 | 0 | 0 | 0 |
| 7:45 AM | 0 | 0 | 0 | 0 | 0 | 0 | 0 | 0 | 0 |
| 8:00 AM | 0 | 0 | 0 | 0 | 0 | 0 | 0 | 0 | 0 |
| 8:15 AM | 0 | 0 | 0 | 0 | 0 | 0 | 0 | 0 | 0 |
| 8:30 AM | 0 | 0 | 0 | 0 | 0 | 0 | 0 | 0 | 0 |
| 8:45 AM | 0 | 0 | 0 | 0 | 0 | 0 | 0 | 0 | 0 |
| 9:00 AM | 0 | 0 | 0 | 0 | 0 | 0 | 0 | 0 | 0 |
| 9:15 AM | 0 | 0 | 0 | 0 | 0 | 0 | 0 | 0 | 0 |
| 9:30 AM | 0 | 0 | 0 | 0 | 0 | 0 | 0 | 0 | 0 |
| 9:45 AM | 0 | 0 | 0 | 0 | 0 | 0 | 0 | 0 | 0 |
| TOTAL VOLUMES : | EB | WB | EB | WB | NB | SB | NB | SB | TOTAL |
| APPROACH %'s : | 0 | 0 | 0 | 0 | 0 | 0 | 0 | 0 | 0 |
| PEAK HR : | 07:15 AM - 08:15 AM | | | | | | | | TOTAL |
| PEAK HR VOL : | 0 | 0 | 0 | 0 | 0 | 0 | 0 | 0 | 0 |
| PEAK HR FACTOR : | | | | | | | | | |

| NS/EW Streets: | NORTH LEG | | SOUTH LEG | | EAST LEG | | WEST LEG | | TOTAL |
|------------------|---------------------|----|-----------|----|----------|----|----------|----|-------|
| | EB | WB | EB | WB | NB | SB | NB | SB | |
| | NOON | | | | | | | | |
| 10:00 AM | 0 | 0 | 0 | 0 | 0 | 0 | 0 | 0 | 0 |
| 10:15 AM | 0 | 0 | 0 | 0 | 0 | 0 | 0 | 0 | 0 |
| 10:30 AM | 0 | 0 | 0 | 0 | 0 | 0 | 0 | 0 | 0 |
| 10:45 AM | 0 | 0 | 0 | 0 | 0 | 0 | 0 | 0 | 0 |
| 11:00 AM | 0 | 0 | 0 | 0 | 0 | 0 | 0 | 0 | 0 |
| 11:15 AM | 0 | 0 | 0 | 0 | 0 | 0 | 0 | 0 | 0 |
| 11:30 AM | 0 | 0 | 0 | 0 | 0 | 0 | 0 | 0 | 0 |
| 11:45 AM | 0 | 0 | 0 | 0 | 0 | 0 | 0 | 0 | 0 |
| 12:00 PM | 0 | 0 | 0 | 0 | 0 | 0 | 0 | 0 | 0 |
| 12:15 PM | 0 | 0 | 0 | 0 | 0 | 0 | 0 | 0 | 0 |
| 12:30 PM | 0 | 0 | 0 | 0 | 0 | 0 | 0 | 0 | 0 |
| 12:45 PM | 0 | 0 | 0 | 0 | 0 | 0 | 0 | 0 | 0 |
| 1:00 PM | 0 | 0 | 0 | 0 | 0 | 0 | 0 | 0 | 0 |
| 1:15 PM | 0 | 0 | 0 | 0 | 0 | 0 | 0 | 0 | 0 |
| 1:30 PM | 0 | 0 | 0 | 0 | 0 | 0 | 0 | 0 | 0 |
| 1:45 PM | 0 | 0 | 0 | 0 | 0 | 0 | 0 | 0 | 0 |
| TOTAL VOLUMES : | EB | WB | EB | WB | NB | SB | NB | SB | TOTAL |
| APPROACH %'s : | 0 | 0 | 0 | 0 | 0 | 0 | 0 | 0 | 0 |
| PEAK HR : | 11:30 AM - 12:30 PM | | | | | | | | TOTAL |
| PEAK HR VOL : | 0 | 0 | 0 | 0 | 0 | 0 | 0 | 0 | 0 |
| PEAK HR FACTOR : | | | | | | | | | |

| NS/EW Streets: | NORTH LEG | | SOUTH LEG | | EAST LEG | | WEST LEG | | TOTAL |
|------------------|---------------------|----|-----------|----|----------|----|----------|----|-------|
| | EB | WB | EB | WB | NB | SB | NB | SB | |
| | PM | | | | | | | | |
| 2:00 PM | 0 | 0 | 0 | 0 | 0 | 0 | 0 | 0 | 0 |
| 2:15 PM | 0 | 0 | 0 | 0 | 0 | 0 | 0 | 0 | 0 |
| 2:30 PM | 0 | 0 | 0 | 0 | 0 | 0 | 0 | 0 | 0 |
| 2:45 PM | 0 | 0 | 0 | 0 | 0 | 0 | 0 | 0 | 0 |
| 3:00 PM | 0 | 0 | 0 | 0 | 0 | 0 | 0 | 0 | 0 |
| 3:15 PM | 0 | 0 | 0 | 0 | 0 | 0 | 0 | 0 | 0 |
| 3:30 PM | 0 | 0 | 0 | 0 | 0 | 0 | 0 | 0 | 0 |
| 3:45 PM | 0 | 0 | 0 | 0 | 0 | 0 | 0 | 0 | 0 |
| 4:00 PM | 0 | 0 | 0 | 0 | 0 | 0 | 0 | 0 | 0 |
| 4:15 PM | 0 | 0 | 0 | 0 | 0 | 0 | 0 | 0 | 0 |
| 4:30 PM | 0 | 0 | 0 | 0 | 0 | 0 | 0 | 0 | 0 |
| 4:45 PM | 0 | 0 | 0 | 0 | 0 | 0 | 0 | 0 | 0 |
| 5:00 PM | 0 | 0 | 0 | 0 | 0 | 0 | 0 | 0 | 0 |
| 5:15 PM | 0 | 0 | 0 | 0 | 0 | 0 | 0 | 0 | 0 |
| 5:30 PM | 0 | 0 | 0 | 0 | 0 | 0 | 0 | 0 | 0 |
| 5:45 PM | 0 | 0 | 0 | 0 | 0 | 0 | 0 | 0 | 0 |
| 6:00 PM | 0 | 0 | 0 | 0 | 0 | 0 | 0 | 0 | 0 |
| 6:15 PM | 0 | 0 | 0 | 0 | 0 | 0 | 0 | 0 | 0 |
| 6:30 PM | 0 | 0 | 0 | 0 | 0 | 0 | 0 | 0 | 0 |
| 6:45 PM | 0 | 0 | 0 | 0 | 0 | 0 | 0 | 0 | 0 |
| TOTAL VOLUMES : | EB | WB | EB | WB | NB | SB | NB | SB | TOTAL |
| APPROACH %'s : | 0 | 0 | 0 | 0 | 0 | 0 | 0 | 0 | 0 |
| PEAK HR : | 05:00 PM - 06:00 PM | | | | | | | | TOTAL |
| PEAK HR VOL : | 0 | 0 | 0 | 0 | 0 | 0 | 0 | 0 | 0 |
| PEAK HR FACTOR : | | | | | | | | | |

Cagle Mill Rd/Noah Martin Rd & Whitehall Rd

Peak Hour Turning Movement Count

ID: 22-180056-004
City: Lula

Day: Wednesday
Date: 3/30/2022

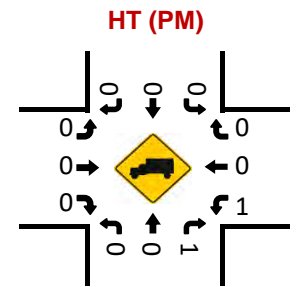
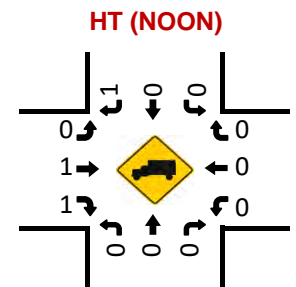
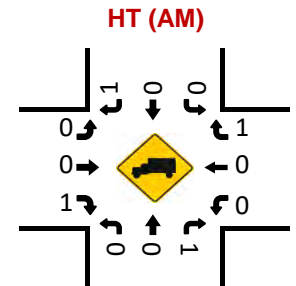
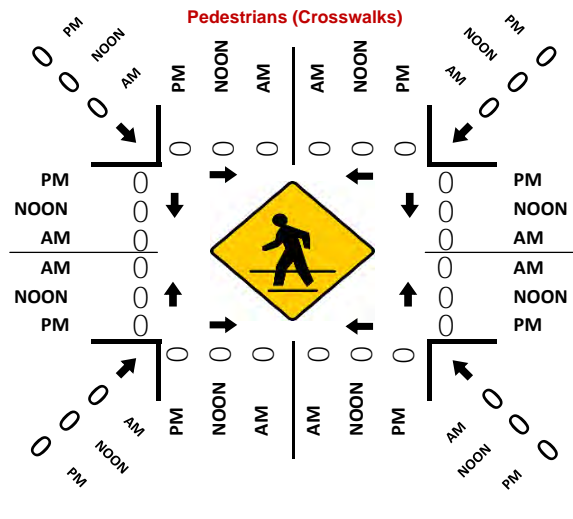
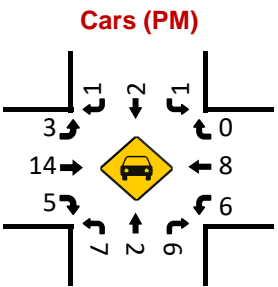
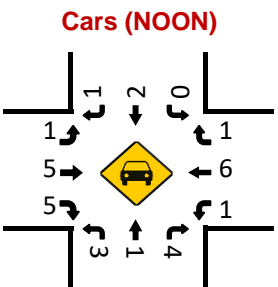
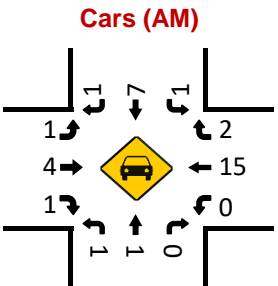
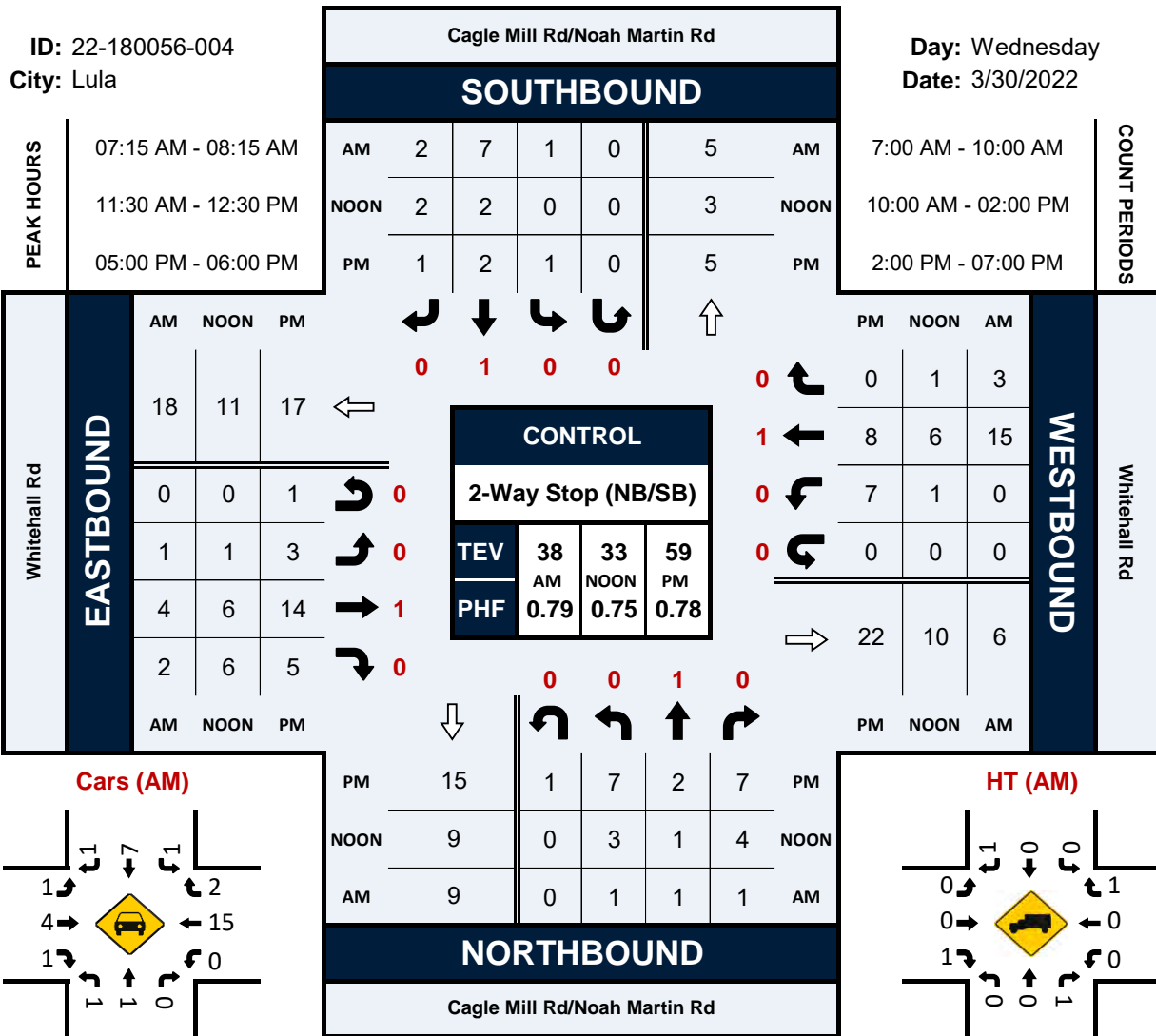

Project ID: 22-180056-004

Location: Cagle Mill Rd/Noah Martin Rd & Whitehall Rd
 City: Lula

Day: Wednesday
 Date: 3/30/2022

Groups Printed - Cars, PU, Vans - Heavy Trucks

| Start Time | Cagle Mill Rd/Noah Martin Rd Northbound | | | | | | Cagle Mill Rd/Noah Martin Rd Southbound | | | | | | Whitehall Rd Eastbound | | | | | | Whitehall Rd Westbound | | | | | | Int. Total |
|------------------|---|-------|------|-------|------|------------|---|-------|------|-------|------|------------|------------------------|------|------|-------|------|------------|------------------------|------|------|-------|------|------------|------------|
| | Left | Thru | Rgt | Utum | Peds | App. Total | Left | Thru | Rgt | Utum | Peds | App. Total | Left | Thru | Rgt | Utum | Peds | App. Total | Left | Thru | Rgt | Utum | Peds | App. Total | |
| 7:00 AM | 0 | 0 | 0 | 0 | 0 | 0 | 0 | 0 | 1 | 0 | 0 | 1 | 0 | 1 | 0 | 0 | 0 | 1 | 0 | 2 | 0 | 0 | 0 | 2 | 4 |
| 7:15 AM | 0 | 0 | 1 | 0 | 0 | 1 | 0 | 2 | 1 | 0 | 0 | 3 | 0 | 3 | 0 | 0 | 0 | 3 | 0 | 1 | 0 | 0 | 0 | 1 | 8 |
| 7:30 AM | 1 | 0 | 0 | 0 | 0 | 1 | 0 | 1 | 1 | 0 | 0 | 2 | 0 | 0 | 1 | 0 | 0 | 1 | 0 | 6 | 2 | 0 | 0 | 8 | 12 |
| 7:45 AM | 0 | 0 | 0 | 0 | 0 | 0 | 1 | 2 | 0 | 0 | 0 | 3 | 0 | 0 | 0 | 0 | 0 | 0 | 0 | 4 | 0 | 0 | 0 | 4 | 7 |
| Total | 1 | 0 | 1 | 0 | 0 | 2 | 1 | 5 | 3 | 0 | 0 | 9 | 0 | 4 | 1 | 0 | 0 | 5 | 0 | 13 | 2 | 0 | 0 | 15 | 31 |
| 8:00 AM | 0 | 1 | 0 | 0 | 0 | 1 | 0 | 2 | 0 | 0 | 0 | 2 | 1 | 1 | 1 | 0 | 0 | 3 | 0 | 4 | 1 | 0 | 0 | 5 | 11 |
| 8:15 AM | 1 | 0 | 0 | 0 | 0 | 1 | 1 | 1 | 1 | 0 | 0 | 3 | 0 | 0 | 1 | 0 | 0 | 1 | 0 | 2 | 0 | 0 | 0 | 2 | 7 |
| 8:30 AM | 0 | 0 | 0 | 0 | 0 | 0 | 0 | 0 | 0 | 0 | 0 | 0 | 0 | 1 | 0 | 0 | 0 | 1 | 0 | 2 | 0 | 0 | 0 | 2 | 3 |
| 8:45 AM | 0 | 0 | 0 | 0 | 0 | 0 | 0 | 1 | 0 | 0 | 0 | 1 | 0 | 3 | 0 | 0 | 0 | 3 | 0 | 1 | 0 | 0 | 0 | 1 | 5 |
| Total | 1 | 1 | 0 | 0 | 0 | 2 | 1 | 4 | 1 | 0 | 0 | 6 | 1 | 5 | 2 | 0 | 0 | 8 | 0 | 9 | 1 | 0 | 0 | 10 | 26 |
| 9:00 AM | 0 | 0 | 1 | 0 | 0 | 1 | 0 | 1 | 0 | 0 | 0 | 1 | 0 | 0 | 0 | 0 | 0 | 0 | 0 | 0 | 0 | 0 | 0 | 0 | 2 |
| 9:15 AM | 1 | 1 | 0 | 0 | 0 | 2 | 0 | 0 | 1 | 0 | 0 | 1 | 1 | 0 | 0 | 0 | 0 | 1 | 0 | 0 | 0 | 0 | 0 | 0 | 4 |
| 9:30 AM | 0 | 0 | 0 | 0 | 0 | 0 | 0 | 1 | 0 | 0 | 0 | 1 | 0 | 1 | 0 | 0 | 0 | 1 | 0 | 1 | 0 | 0 | 0 | 1 | 3 |
| 9:45 AM | 0 | 1 | 0 | 0 | 0 | 1 | 0 | 2 | 0 | 0 | 0 | 2 | 0 | 0 | 0 | 0 | 0 | 0 | 1 | 1 | 1 | 0 | 0 | 3 | 6 |
| Total | 1 | 2 | 1 | 0 | 0 | 4 | 0 | 4 | 1 | 0 | 0 | 5 | 1 | 1 | 0 | 0 | 0 | 2 | 1 | 2 | 1 | 0 | 0 | 4 | 15 |
| ***BREAK*** | | | | | | | | | | | | | | | | | | | | | | | | | |
| 10:00 AM | 0 | 0 | 0 | 0 | 0 | 0 | 0 | 0 | 0 | 0 | 0 | 0 | 0 | 1 | 0 | 0 | 0 | 1 | 0 | 1 | 1 | 0 | 0 | 2 | 3 |
| 10:15 AM | 0 | 0 | 0 | 0 | 0 | 0 | 0 | 2 | 1 | 0 | 0 | 3 | 0 | 1 | 0 | 0 | 0 | 1 | 0 | 0 | 0 | 0 | 0 | 0 | 4 |
| 10:30 AM | 1 | 1 | 0 | 0 | 0 | 2 | 0 | 0 | 0 | 0 | 0 | 0 | 0 | 2 | 1 | 0 | 0 | 3 | 1 | 1 | 0 | 0 | 0 | 2 | 7 |
| 10:45 AM | 1 | 0 | 0 | 0 | 0 | 1 | 0 | 1 | 0 | 0 | 0 | 1 | 1 | 0 | 0 | 0 | 0 | 1 | 1 | 1 | 0 | 0 | 0 | 2 | 5 |
| Total | 2 | 1 | 0 | 0 | 0 | 3 | 0 | 3 | 1 | 0 | 0 | 4 | 1 | 4 | 1 | 0 | 0 | 6 | 2 | 3 | 1 | 0 | 0 | 6 | 19 |
| 11:00 AM | 1 | 0 | 0 | 0 | 0 | 1 | 0 | 0 | 0 | 1 | 0 | 1 | 0 | 1 | 0 | 0 | 0 | 1 | 2 | 1 | 0 | 0 | 0 | 3 | 6 |
| 11:15 AM | 0 | 0 | 0 | 0 | 0 | 0 | 0 | 0 | 0 | 0 | 0 | 0 | 0 | 0 | 1 | 0 | 0 | 1 | 0 | 0 | 0 | 0 | 0 | 0 | 1 |
| 11:30 AM | 1 | 0 | 1 | 0 | 0 | 2 | 0 | 1 | 0 | 0 | 0 | 1 | 1 | 4 | 1 | 0 | 0 | 6 | 0 | 1 | 1 | 0 | 0 | 2 | 11 |
| 11:45 AM | 2 | 0 | 0 | 0 | 0 | 2 | 0 | 0 | 1 | 0 | 0 | 1 | 0 | 0 | 4 | 0 | 0 | 4 | 0 | 1 | 0 | 0 | 0 | 1 | 8 |
| Total | 4 | 0 | 1 | 0 | 0 | 5 | 0 | 1 | 1 | 1 | 0 | 3 | 1 | 5 | 6 | 0 | 0 | 12 | 2 | 3 | 1 | 0 | 0 | 6 | 26 |
| 12:00 PM | 0 | 1 | 1 | 0 | 0 | 2 | 0 | 1 | 0 | 0 | 0 | 1 | 0 | 1 | 1 | 0 | 0 | 2 | 1 | 2 | 0 | 0 | 0 | 3 | 8 |
| 12:15 PM | 0 | 0 | 2 | 0 | 0 | 2 | 0 | 0 | 1 | 0 | 0 | 1 | 0 | 1 | 0 | 0 | 0 | 1 | 0 | 2 | 0 | 0 | 0 | 2 | 6 |
| 12:30 PM | 0 | 0 | 0 | 0 | 0 | 0 | 0 | 1 | 0 | 0 | 0 | 1 | 0 | 2 | 0 | 0 | 0 | 2 | 0 | 2 | 0 | 0 | 0 | 2 | 5 |
| 12:45 PM | 0 | 0 | 1 | 0 | 0 | 1 | 0 | 3 | 0 | 0 | 0 | 3 | 0 | 0 | 2 | 0 | 0 | 2 | 0 | 2 | 0 | 0 | 0 | 2 | 8 |
| Total | 0 | 1 | 4 | 0 | 0 | 5 | 0 | 5 | 1 | 0 | 0 | 6 | 0 | 4 | 3 | 0 | 0 | 7 | 1 | 8 | 0 | 0 | 0 | 9 | 27 |
| 1:00 PM | 0 | 0 | 0 | 0 | 0 | 0 | 0 | 0 | 0 | 0 | 0 | 0 | 0 | 1 | 1 | 0 | 0 | 2 | 0 | 0 | 0 | 0 | 0 | 0 | 2 |
| 1:15 PM | 2 | 0 | 0 | 0 | 0 | 2 | 0 | 0 | 0 | 0 | 0 | 0 | 2 | 2 | 0 | 0 | 0 | 4 | 0 | 0 | 0 | 0 | 0 | 0 | 6 |
| 1:30 PM | 1 | 0 | 1 | 0 | 0 | 2 | 1 | 0 | 0 | 0 | 0 | 1 | 0 | 1 | 1 | 0 | 0 | 2 | 1 | 2 | 0 | 0 | 0 | 3 | 8 |
| 1:45 PM | 1 | 1 | 0 | 0 | 0 | 2 | 0 | 1 | 0 | 0 | 0 | 1 | 0 | 1 | 0 | 0 | 0 | 1 | 1 | 0 | 0 | 0 | 0 | 1 | 5 |
| Total | 4 | 1 | 1 | 0 | 0 | 6 | 1 | 1 | 0 | 0 | 0 | 2 | 2 | 5 | 2 | 0 | 0 | 9 | 2 | 2 | 0 | 0 | 0 | 4 | 21 |
| ***BREAK*** | | | | | | | | | | | | | | | | | | | | | | | | | |
| 2:00 PM | 0 | 0 | 1 | 0 | 0 | 1 | 0 | 0 | 0 | 0 | 0 | 0 | 0 | 2 | 0 | 0 | 0 | 2 | 1 | 1 | 0 | 0 | 0 | 2 | 5 |
| 2:15 PM | 0 | 1 | 3 | 0 | 0 | 4 | 1 | 0 | 0 | 0 | 0 | 1 | 0 | 1 | 1 | 0 | 0 | 2 | 0 | 1 | 0 | 0 | 0 | 1 | 8 |
| 2:30 PM | 0 | 1 | 3 | 0 | 0 | 4 | 0 | 0 | 0 | 0 | 0 | 0 | 0 | 1 | 0 | 0 | 0 | 1 | 1 | 3 | 1 | 0 | 0 | 5 | 10 |
| 2:45 PM | 0 | 0 | 0 | 0 | 0 | 0 | 1 | 2 | 0 | 0 | 0 | 3 | 1 | 1 | 1 | 0 | 0 | 3 | 0 | 3 | 1 | 0 | 0 | 4 | 10 |
| Total | 0 | 2 | 7 | 0 | 0 | 9 | 2 | 2 | 0 | 0 | 0 | 4 | 1 | 5 | 2 | 0 | 0 | 8 | 2 | 8 | 2 | 0 | 0 | 12 | 33 |
| 3:00 PM | 0 | 1 | 0 | 0 | 0 | 1 | 0 | 0 | 0 | 0 | 0 | 0 | 0 | 0 | 0 | 0 | 0 | 0 | 0 | 0 | 0 | 0 | 0 | 0 | 1 |
| 3:15 PM | 1 | 2 | 2 | 0 | 0 | 5 | 0 | 0 | 0 | 0 | 0 | 0 | 0 | 3 | 0 | 0 | 0 | 3 | 0 | 0 | 0 | 0 | 0 | 0 | 8 |
| 3:30 PM | 0 | 0 | 1 | 0 | 0 | 1 | 0 | 1 | 0 | 0 | 0 | 1 | 0 | 4 | 0 | 0 | 0 | 4 | 0 | 3 | 0 | 0 | 0 | 3 | 9 |
| 3:45 PM | 1 | 0 | 1 | 0 | 0 | 2 | 0 | 0 | 1 | 0 | 0 | 1 | 0 | 0 | 1 | 0 | 0 | 1 | 0 | 0 | 0 | 0 | 0 | 0 | 4 |
| Total | 2 | 3 | 4 | 0 | 0 | 9 | 0 | 1 | 1 | 0 | 0 | 2 | 0 | 7 | 1 | 0 | 0 | 8 | 0 | 3 | 0 | 0 | 0 | 3 | 22 |
| 4:00 PM | 2 | 0 | 1 | 0 | 0 | 3 | 1 | 1 | 1 | 0 | 0 | 3 | 1 | 2 | 2 | 0 | 0 | 5 | 0 | 4 | 1 | 0 | 0 | 5 | 16 |
| 4:15 PM | 0 | 0 | 3 | 0 | 0 | 3 | 1 | 0 | 1 | 0 | 0 | 2 | 0 | 2 | 1 | 0 | 0 | 3 | 0 | 2 | 0 | 0 | 0 | 2 | 10 |
| 4:30 PM | 1 | 1 | 0 | 0 | 0 | 2 | 0 | 0 | 0 | 0 | 0 | 0 | 1 | 5 | 2 | 0 | 0 | 8 | 0 | 0 | 4 | 0 | 0 | 4 | 14 |
| 4:45 PM | 2 | 1 | 0 | 0 | 0 | 3 | 0 | 0 | 0 | 0 | 0 | 0 | 1 | 3 | 0 | 0 | 0 | 4 | 2 | 0 | 0 | 0 | 0 | 2 | 9 |
| Total | 5 | 2 | 4 | 0 | 0 | 11 | 2 | 1 | 2 | 0 | 0 | 5 | 3 | 12 | 5 | 0 | 0 | 20 | 2 | 6 | 5 | 0 | 0 | 13 | 49 |
| 5:00 PM | 2 | 0 | 1 | 1 | 0 | 4 | 1 | 2 | 0 | 0 | 0 | 3 | 2 | 3 | 0 | 0 | 0 | 5 | 1 | 2 | 0 | 0 | 0 | 3 | 15 |
| 5:15 PM | 0 | 1 | 2 | 0 | 0 | 3 | 0 | 0 | 0 | 0 | 0 | 0 | 0 | 3 | 1 | 0 | 0 | 4 | 1 | 1 | 0 | 0 | 0 | 2 | 9 |
| 5:30 PM | 5 | 1 | 2 | 0 | 0 | 8 | 0 | 0 | 1 | 0 | 0 | 1 | 0 | 4 | 1 | 1 | 0 | 6 | 1 | 3 | 0 | 0 | 0 | 4 | 19 |
| 5:45 PM | 0 | 0 | 2 | 0 | 0 | 2 | 0 | 0 | 0 | 0 | 0 | 0 | 1 | 4 | 3 | 0 | 0 | 8 | 4 | 2 | 0 | 0 | 0 | 6 | 16 |
| Total | 7 | 2 | 7 | 1 | 0 | 17 | 1 | 2 | 1 | 0 | 0 | 4 | 3 | 14 | 5 | 1 | 0 | 23 | 7 | 8 | 0 | 0 | 0 | 15 | 59 |
| 6:00 PM | 1 | 1 | 1 | 0 | 0 | 3 | 1 | 0 | 0 | 0 | 0 | 1 | 1 | 1 | 1 | 0 | 0 | 3 | 0 | 1 | 0 | 0 | 0 | 1 | 8 |
| 6:15 PM | 2 | 1 | 0 | 0 | 0 | 3 | 0 | 0 | 1 | 0 | 0 | 1 | 0 | 3 | 2 | 0 | 0 | 5 | 0 | 2 | 0 | 0 | 0 | 2 | 11 |
| 6:30 PM | 2 | 1 | 1 | 0 | 0 | 4 | 0 | 1 | 0 | 0 | 0 | 1 | 0 | 3 | 2 | 0 | 0 | 5 | 4 | 0 | 0 | 1 | 0 | 5 | 15 |
| 6:45 PM | 0 | 0 | 3 | 0 | 0 | 3 | 0 | 1 | 0 | 0 | 0 | 1 | 1 | 4 | 2 | 0 | 0 | 7 | 0 | 1 | 1 | 0 | 0 | 2 | 13 |
| Total | 5 | 3 | 5 | 0 | 0 | 13 | 1 | 2 | 1 | 0 | 0 | 4 | 2 | 11 | 7 | 0 | 0 | 20 | 4 | 4 | 1 | 1 | 0 | 10 | 47 |
| Grand Total | 32 | 18 | 35 | 1 | 0 | 86 | 9 | 31 | 13 | 1 | 0 | 54 | 15 | 77 | 35 | 1 | 0 | 128 | 23 | 69 | 14 | 1 | 0 | 107 | 375 |
| Approch % | 37.2 | 20.9 | 40.7 | 1.2 | 0.0 | | 16.7 | 57.4 | 24.1 | 1.9 | 0.0 | | 11.7 | 60.2 | 27.3 | 0.8 | 0.0 | | 21.5 | 64.5 | 13.1 | 0.9 | 0.0 | | |
| Total % | 8.5 | 4.8 | 9.3 | 0.3 | 0.0 | 22.9 | 2.4 | 8.3 | 3.5 | 0.3 | 0.0 | 14.4 | 4.0 | 20.5 | 9.3 | 0.3 | 0.0 | 34.1 | 6.1 | 18.4 | 3.7 | 0.3 | 0.0 | 28.5 | |
| Cars, PU, Vans | 32 | 18 | 31 | 1 | | 82 | 9 | 31 | 9 | 1 | | 50 | 15 | 74 | 30 | 1 | | 120 | 21 | 68 | 12 | 1 | | 102 | 354 |
| % Cars, PU, Vans | 100.0 | 100.0 | 88.6 | 100.0 | | 95.3 | 100.0 | 100.0 | 69.2 | 100.0 | | 92.6 | 100.0 | 96.1 | 85.7 | 100.0 | | 93.8 | 91.3 | 98.6 | 85.7 | 100.0 | | 95.3 | 94.4 |
| Heavy trucks | 0 | 0 | 4 | 0 | | 4 | 0 | 0 | 4 | 0 | | 4 | 0 | 3 | 5 | 0 | | 8 | 2 | 1 | 2 | 0 | | 5 | 21 |

| | | | | | | | | | | | | | | | | | | | | | |
|---------------|-----|-----|------|-----|-----|-----|-----|------|-----|-----|-----|-----|------|-----|-----|-----|-----|------|-----|-----|-----|
| %Heavy trucks | 0.0 | 0.0 | 11.4 | 0.0 | 4.7 | 0.0 | 0.0 | 30.8 | 0.0 | 7.4 | 0.0 | 3.9 | 14.3 | 0.0 | 6.3 | 8.7 | 1.4 | 14.3 | 0.0 | 4.7 | 5.6 |
|---------------|-----|-----|------|-----|-----|-----|-----|------|-----|-----|-----|-----|------|-----|-----|-----|-----|------|-----|-----|-----|

Project ID: 22-180056-004

Location: Cagle Mill Rd/Noah Martin Rd & Whitehall Rd
City: Lula

PEAK HOURS

Day: Wednesday
Date: 3/30/2022

AM

| Start Time | Cagle Mill Rd/Noah Martin Rd Northbound | | | | | Cagle Mill Rd/Noah Martin Rd Southbound | | | | | Whitehall Rd Eastbound | | | | | Whitehall Rd Westbound | | | | | Int. Total |
|--|---|-------|-------|------|------------|---|-------|------|------|------------|------------------------|-------|------|------|------------|------------------------|-------|------|------|------------|------------|
| | Left | Thru | Rgt | Utum | App. Total | Left | Thru | Rgt | Utum | App. Total | Left | Thru | Rgt | Utum | App. Total | Left | Thru | Rgt | Utum | App. Total | |
| Peak Hour Analysis from 07:00 AM - 10:00 AM | | | | | | | | | | | | | | | | | | | | | |
| Peak Hour for Entire Intersection Begins at 07:15 AM | | | | | | | | | | | | | | | | | | | | | |
| 7:15 AM | 0 | 0 | 1 | 0 | 1 | 0 | 2 | 1 | 0 | 3 | 0 | 3 | 0 | 0 | 3 | 0 | 1 | 0 | 0 | 1 | 8 |
| 7:30 AM | 1 | 0 | 0 | 0 | 1 | 0 | 1 | 1 | 0 | 2 | 0 | 0 | 1 | 0 | 1 | 0 | 6 | 2 | 0 | 8 | 12 |
| 7:45 AM | 0 | 0 | 0 | 0 | 0 | 1 | 2 | 0 | 0 | 3 | 0 | 0 | 0 | 0 | 0 | 0 | 4 | 0 | 0 | 4 | 7 |
| 8:00 AM | 0 | 1 | 0 | 0 | 1 | 0 | 2 | 0 | 0 | 2 | 1 | 1 | 1 | 0 | 3 | 0 | 4 | 1 | 0 | 5 | 11 |
| Total Volume | 1 | 1 | 1 | 0 | 3 | 1 | 7 | 2 | 0 | 10 | 1 | 4 | 2 | 0 | 7 | 0 | 15 | 3 | 0 | 18 | 38 |
| % App. Total | 33.3 | 33.3 | 33.3 | 0.0 | 100 | 10.0 | 70.0 | 20.0 | 0.0 | 100 | 14.3 | 57.1 | 28.6 | 0.0 | 100 | 0.0 | 83.3 | 16.7 | 0.0 | 100 | |
| PHF | 0.750 | | | | | 0.833 | | | | | 0.583 | | | | | 0.792 | | | | | |
| Cars, PU, Vans | 1 | 1 | 0 | 0 | 2 | 1 | 7 | 1 | 0 | 9 | 1 | 4 | 1 | 0 | 6 | 0 | 15 | 2 | 0 | 17 | 34 |
| % Cars, PU, Vans | 100.0 | 100.0 | 0.0 | 0.0 | 66.7 | 100.0 | 100.0 | 50.0 | 0.0 | 90.0 | 100.0 | 100.0 | 50.0 | 0.0 | 85.7 | 0.0 | 100.0 | 66.7 | 0.0 | 94.4 | 89.5 |
| Heavy trucks | 0 | 0 | 1 | 0 | 1 | 0 | 0 | 1 | 0 | 1 | 0 | 0 | 1 | 0 | 1 | 0 | 0 | 1 | 0 | 1 | 4 |
| % Heavy trucks | 0.0 | 0.0 | 100.0 | 0.0 | 33.3 | 0.0 | 0.0 | 50.0 | 0.0 | 10.0 | 0.0 | 0.0 | 50.0 | 0.0 | 14.3 | 0.0 | 0.0 | 33.3 | 0.0 | 5.6 | 10.5 |

NOON

| Start Time | Cagle Mill Rd/Noah Martin Rd Northbound | | | | | Cagle Mill Rd/Noah Martin Rd Southbound | | | | | Whitehall Rd Eastbound | | | | | Whitehall Rd Westbound | | | | | Int. Total |
|--|---|-------|-------|------|------------|---|-------|------|------|------------|------------------------|------|------|------|------------|------------------------|-------|-------|------|------------|------------|
| | Left | Thru | Rgt | Utum | App. Total | Left | Thru | Rgt | Utum | App. Total | Left | Thru | Rgt | Utum | App. Total | Left | Thru | Rgt | Utum | App. Total | |
| Peak Hour Analysis from 10:00 AM - 02:00 PM | | | | | | | | | | | | | | | | | | | | | |
| Peak Hour for Entire Intersection Begins at 11:30 AM | | | | | | | | | | | | | | | | | | | | | |
| 11:30 AM | 1 | 0 | 1 | 0 | 2 | 0 | 1 | 0 | 0 | 1 | 1 | 4 | 1 | 0 | 6 | 0 | 1 | 1 | 0 | 2 | 11 |
| 11:45 AM | 2 | 0 | 0 | 0 | 2 | 0 | 0 | 1 | 0 | 1 | 0 | 0 | 4 | 0 | 4 | 0 | 1 | 0 | 0 | 1 | 8 |
| 12:00 PM | 0 | 1 | 1 | 0 | 2 | 0 | 1 | 0 | 0 | 1 | 0 | 1 | 1 | 0 | 2 | 1 | 2 | 0 | 0 | 3 | 8 |
| 12:15 PM | 0 | 0 | 2 | 0 | 2 | 0 | 0 | 1 | 0 | 1 | 0 | 1 | 0 | 0 | 1 | 0 | 2 | 0 | 0 | 2 | 6 |
| Total Volume | 3 | 1 | 4 | 0 | 8 | 0 | 2 | 2 | 0 | 4 | 1 | 6 | 6 | 0 | 13 | 1 | 6 | 1 | 0 | 8 | 33 |
| % App. Total | 37.5 | 12.5 | 50.0 | 0.0 | 100 | 0.0 | 50.0 | 50.0 | 0.0 | 100 | 7.7 | 46.2 | 46.2 | 0.0 | 100 | 12.5 | 75.0 | 12.5 | 0.0 | 100 | |
| PHF | 1.000 | | | | | 1.000 | | | | | 0.542 | | | | | 0.667 | | | | | |
| Cars, PU, Vans | 3 | 1 | 4 | 0 | 8 | 0 | 2 | 1 | 0 | 3 | 1 | 5 | 5 | 0 | 11 | 1 | 6 | 1 | 0 | 8 | 30 |
| % Cars, PU, Vans | 100.0 | 100.0 | 100.0 | 0.0 | 100.0 | 0.0 | 100.0 | 50.0 | 0.0 | 75.0 | 100.0 | 83.3 | 83.3 | 0.0 | 84.6 | 100.0 | 100.0 | 100.0 | 0.0 | 100.0 | 90.9 |
| Heavy trucks | 0 | 0 | 0 | 0 | 0 | 0 | 0 | 1 | 0 | 1 | 0 | 1 | 1 | 0 | 2 | 0 | 0 | 0 | 0 | 0 | 3 |
| % Heavy trucks | 0.0 | 0.0 | 0.0 | 0.0 | 0.0 | 0.0 | 0.0 | 50.0 | 0.0 | 25.0 | 0.0 | 16.7 | 16.7 | 0.0 | 15.4 | 0.0 | 0.0 | 0.0 | 0.0 | 0.0 | 9.1 |

PM

| Start Time | Cagle Mill Rd/Noah Martin Rd Northbound | | | | | Cagle Mill Rd/Noah Martin Rd Southbound | | | | | Whitehall Rd Eastbound | | | | | Whitehall Rd Westbound | | | | | Int. Total |
|--|---|-------|------|-------|------------|---|-------|-------|------|------------|------------------------|-------|-------|-------|------------|------------------------|-------|-----|------|------------|------------|
| | Left | Thru | Rgt | Utum | App. Total | Left | Thru | Rgt | Utum | App. Total | Left | Thru | Rgt | Utum | App. Total | Left | Thru | Rgt | Utum | App. Total | |
| Peak Hour Analysis from 02:00 PM - 07:00 PM | | | | | | | | | | | | | | | | | | | | | |
| Peak Hour for Entire Intersection Begins at 05:00 PM | | | | | | | | | | | | | | | | | | | | | |
| 5:00 PM | 2 | 0 | 1 | 1 | 4 | 1 | 2 | 0 | 0 | 3 | 2 | 3 | 0 | 0 | 5 | 1 | 2 | 0 | 0 | 3 | 15 |
| 5:15 PM | 0 | 1 | 2 | 0 | 3 | 0 | 0 | 0 | 0 | 0 | 0 | 3 | 1 | 0 | 4 | 1 | 1 | 0 | 0 | 2 | 9 |
| 5:30 PM | 5 | 1 | 2 | 0 | 8 | 0 | 0 | 1 | 0 | 1 | 0 | 4 | 1 | 1 | 6 | 1 | 3 | 0 | 0 | 4 | 19 |
| 5:45 PM | 0 | 0 | 2 | 0 | 2 | 0 | 0 | 0 | 0 | 0 | 1 | 4 | 3 | 0 | 8 | 4 | 2 | 0 | 0 | 6 | 16 |
| Total Volume | 7 | 2 | 7 | 1 | 17 | 1 | 2 | 1 | 0 | 4 | 3 | 14 | 5 | 1 | 23 | 7 | 8 | 0 | 0 | 15 | 59 |
| % App. Total | 41.2 | 11.8 | 41.2 | 5.9 | 100 | 25.0 | 50.0 | 25.0 | 0.0 | 100 | 13.0 | 60.9 | 21.7 | 4.3 | 100 | 46.7 | 53.3 | 0.0 | 0.0 | 100 | |
| PHF | 0.531 | | | | | 0.333 | | | | | 0.719 | | | | | 0.625 | | | | | |
| Cars, PU, Vans | 7 | 2 | 6 | 1 | 16 | 1 | 2 | 1 | 0 | 4 | 3 | 14 | 5 | 1 | 23 | 6 | 8 | 0 | 0 | 14 | 57 |
| % Cars, PU, Vans | 100.0 | 100.0 | 85.7 | 100.0 | 94.1 | 100.0 | 100.0 | 100.0 | 0.0 | 100.0 | 100.0 | 100.0 | 100.0 | 100.0 | 100.0 | 85.7 | 100.0 | 0.0 | 0.0 | 93.3 | 96.6 |
| Heavy trucks | 0 | 0 | 1 | 0 | 1 | 0 | 0 | 0 | 0 | 0 | 0 | 0 | 0 | 0 | 0 | 1 | 0 | 0 | 0 | 1 | 2 |
| % Heavy trucks | 0.0 | 0.0 | 14.3 | 0.0 | 5.9 | 0.0 | 0.0 | 0.0 | 0.0 | 0.0 | 0.0 | 0.0 | 0.0 | 0.0 | 0.0 | 14.3 | 0.0 | 0.0 | 0.0 | 6.7 | 3.4 |

National Data & Surveying Services Intersection Turning Movement Count

Location: Noah Martin Rd & Old Cornelia Hwy
 City: Lula
 Control: 1-Way Stop (SB)

Project ID: 22-180056-005
 Date: 3/30/2022

Data - Total

| NS/EW Streets: | Noah Martin Rd | | | | Noah Martin Rd | | | | Old Cornelia Hwy | | | | Old Cornelia Hwy | | | | |
|-----------------|---------------------|-------|-------|-------|----------------|-------|--------|-------|------------------|--------|-------|-------|------------------|--------|-------|-------|-------|
| AM | NORTHBOUND | | | | SOUTHBOUND | | | | EASTBOUND | | | | WESTBOUND | | | | TOTAL |
| | NL | NT | NR | NU | SL | ST | SR | SU | EL | ET | ER | EU | WL | WT | WR | WU | |
| 7:00 AM | 0 | 0 | 0 | 0 | 0 | 0 | 2 | 0 | 0 | 10 | 0 | 0 | 0 | 58 | 0 | 0 | 70 |
| 7:15 AM | 0 | 0 | 0 | 0 | 0 | 0 | 0 | 0 | 0 | 12 | 0 | 0 | 0 | 71 | 1 | 0 | 84 |
| 7:30 AM | 0 | 0 | 0 | 0 | 0 | 0 | 4 | 0 | 0 | 19 | 0 | 0 | 0 | 101 | 0 | 0 | 124 |
| 7:45 AM | 0 | 0 | 0 | 0 | 1 | 0 | 2 | 0 | 0 | 15 | 0 | 0 | 0 | 93 | 1 | 0 | 112 |
| 8:00 AM | 0 | 0 | 0 | 0 | 0 | 0 | 1 | 0 | 0 | 32 | 0 | 0 | 0 | 90 | 0 | 0 | 123 |
| 8:15 AM | 0 | 0 | 0 | 0 | 1 | 0 | 2 | 0 | 0 | 34 | 0 | 0 | 0 | 45 | 1 | 0 | 83 |
| 8:30 AM | 0 | 0 | 0 | 0 | 0 | 0 | 0 | 0 | 0 | 11 | 0 | 0 | 0 | 38 | 0 | 0 | 49 |
| 8:45 AM | 0 | 0 | 0 | 0 | 0 | 0 | 1 | 0 | 0 | 11 | 0 | 0 | 0 | 32 | 1 | 0 | 45 |
| 9:00 AM | 0 | 0 | 0 | 0 | 0 | 0 | 0 | 0 | 0 | 15 | 0 | 0 | 0 | 28 | 0 | 0 | 43 |
| 9:15 AM | 0 | 0 | 0 | 0 | 0 | 0 | 1 | 0 | 1 | 16 | 0 | 0 | 0 | 32 | 0 | 0 | 50 |
| 9:30 AM | 0 | 0 | 0 | 0 | 1 | 0 | 1 | 0 | 0 | 16 | 0 | 0 | 0 | 26 | 1 | 0 | 45 |
| 9:45 AM | 0 | 0 | 0 | 0 | 0 | 0 | 1 | 0 | 0 | 13 | 0 | 0 | 0 | 38 | 0 | 0 | 52 |
| TOTAL VOLUMES: | NL | NT | NR | NU | SL | ST | SR | SU | EL | ET | ER | EU | WL | WT | WR | WU | TOTAL |
| APPROACH %'s: | 0 | 0 | 0 | 0 | 3 | 0 | 15 | 0 | 1 | 204 | 0 | 0 | 0 | 652 | 5 | 0 | 880 |
| | | | | | 16.67% | 0.00% | 83.33% | 0.00% | 0.49% | 99.51% | 0.00% | 0.00% | 0.00% | 99.24% | 0.76% | 0.00% | |
| PEAK HR: | 07:15 AM - 08:15 AM | | | | | | | | | | | | | | | | TOTAL |
| PEAK HR VOL: | 0 | 0 | 0 | 0 | 1 | 0 | 7 | 0 | 0 | 78 | 0 | 0 | 0 | 355 | 2 | 0 | 443 |
| PEAK HR FACTOR: | 0.000 | 0.000 | 0.000 | 0.000 | 0.250 | 0.000 | 0.438 | 0.000 | 0.000 | 0.609 | 0.000 | 0.000 | 0.000 | 0.879 | 0.500 | 0.000 | 0.893 |
| | | | | | | | 0.500 | | | | 0.609 | | | | 0.884 | | |
| NOON | NORTHBOUND | | | | SOUTHBOUND | | | | EASTBOUND | | | | WESTBOUND | | | | TOTAL |
| | NL | NT | NR | NU | SL | ST | SR | SU | EL | ET | ER | EU | WL | WT | WR | WU | |
| 10:00 AM | 0 | 0 | 0 | 0 | 0 | 0 | 1 | 0 | 0 | 12 | 0 | 0 | 0 | 24 | 0 | 0 | 37 |
| 10:15 AM | 0 | 0 | 0 | 0 | 0 | 0 | 1 | 0 | 0 | 20 | 0 | 0 | 0 | 21 | 1 | 0 | 43 |
| 10:30 AM | 0 | 0 | 0 | 0 | 1 | 0 | 2 | 0 | 0 | 22 | 0 | 0 | 0 | 20 | 0 | 0 | 45 |
| 10:45 AM | 0 | 0 | 0 | 0 | 1 | 0 | 2 | 0 | 1 | 17 | 0 | 0 | 0 | 25 | 2 | 0 | 48 |
| 11:00 AM | 0 | 0 | 0 | 0 | 1 | 0 | 1 | 0 | 0 | 19 | 0 | 0 | 0 | 16 | 0 | 0 | 37 |
| 11:15 AM | 0 | 0 | 0 | 0 | 0 | 0 | 0 | 0 | 0 | 28 | 0 | 0 | 0 | 23 | 1 | 0 | 52 |
| 11:30 AM | 0 | 0 | 0 | 0 | 1 | 0 | 0 | 0 | 1 | 29 | 0 | 0 | 0 | 23 | 0 | 0 | 54 |
| 11:45 AM | 0 | 0 | 0 | 0 | 1 | 0 | 2 | 0 | 0 | 17 | 0 | 0 | 0 | 24 | 1 | 0 | 45 |
| 12:00 PM | 0 | 0 | 0 | 0 | 1 | 0 | 1 | 0 | 2 | 29 | 0 | 0 | 0 | 20 | 0 | 0 | 53 |
| 12:15 PM | 0 | 0 | 0 | 0 | 0 | 0 | 2 | 0 | 2 | 24 | 0 | 0 | 0 | 26 | 0 | 0 | 54 |
| 12:30 PM | 0 | 0 | 0 | 0 | 0 | 0 | 1 | 0 | 0 | 28 | 0 | 0 | 0 | 26 | 0 | 0 | 55 |
| 12:45 PM | 0 | 0 | 0 | 0 | 0 | 0 | 4 | 0 | 1 | 38 | 0 | 0 | 0 | 25 | 0 | 0 | 68 |
| 1:00 PM | 0 | 0 | 0 | 0 | 1 | 0 | 1 | 0 | 1 | 29 | 0 | 0 | 0 | 23 | 1 | 0 | 56 |
| 1:15 PM | 0 | 0 | 0 | 0 | 1 | 0 | 0 | 0 | 0 | 22 | 0 | 0 | 0 | 26 | 0 | 0 | 49 |
| 1:30 PM | 0 | 0 | 0 | 0 | 1 | 0 | 1 | 0 | 2 | 25 | 0 | 0 | 0 | 22 | 1 | 0 | 52 |
| 1:45 PM | 0 | 0 | 0 | 0 | 1 | 0 | 2 | 0 | 1 | 47 | 0 | 0 | 0 | 18 | 1 | 0 | 70 |
| TOTAL VOLUMES: | NL | NT | NR | NU | SL | ST | SR | SU | EL | ET | ER | EU | WL | WT | WR | WU | TOTAL |
| APPROACH %'s: | 0 | 0 | 0 | 0 | 10 | 0 | 21 | 0 | 11 | 406 | 0 | 0 | 0 | 362 | 8 | 0 | 818 |
| | | | | | 32.26% | 0.00% | 67.74% | 0.00% | 2.64% | 97.36% | 0.00% | 0.00% | 0.00% | 97.84% | 2.16% | 0.00% | |
| PEAK HR: | 12:15 PM - 01:15 PM | | | | | | | | | | | | | | | | TOTAL |
| PEAK HR VOL: | 0 | 0 | 0 | 0 | 1 | 0 | 8 | 0 | 4 | 119 | 0 | 0 | 0 | 100 | 1 | 0 | 233 |
| PEAK HR FACTOR: | 0.000 | 0.000 | 0.000 | 0.000 | 0.250 | 0.000 | 0.500 | 0.000 | 0.500 | 0.783 | 0.000 | 0.000 | 0.000 | 0.962 | 0.250 | 0.000 | 0.857 |
| | | | | | | | 0.563 | | | | 0.788 | | | | 0.971 | | |
| PM | NORTHBOUND | | | | SOUTHBOUND | | | | EASTBOUND | | | | WESTBOUND | | | | TOTAL |
| | NL | NT | NR | NU | SL | ST | SR | SU | EL | ET | ER | EU | WL | WT | WR | WU | |
| 2:00 PM | 0 | 0 | 0 | 0 | 0 | 0 | 0 | 0 | 0 | 23 | 0 | 0 | 0 | 27 | 0 | 0 | 50 |
| 2:15 PM | 0 | 0 | 0 | 0 | 1 | 0 | 0 | 0 | 2 | 38 | 0 | 0 | 0 | 25 | 0 | 0 | 66 |
| 2:30 PM | 0 | 0 | 0 | 0 | 1 | 0 | 1 | 0 | 3 | 29 | 0 | 0 | 0 | 39 | 0 | 0 | 73 |
| 2:45 PM | 0 | 0 | 0 | 0 | 2 | 0 | 0 | 0 | 0 | 32 | 0 | 0 | 0 | 40 | 0 | 0 | 74 |
| 3:00 PM | 0 | 0 | 0 | 0 | 0 | 0 | 1 | 0 | 1 | 37 | 0 | 0 | 0 | 34 | 1 | 0 | 74 |
| 3:15 PM | 0 | 0 | 0 | 0 | 0 | 0 | 1 | 0 | 3 | 54 | 0 | 0 | 0 | 26 | 1 | 0 | 85 |
| 3:30 PM | 0 | 0 | 0 | 0 | 0 | 0 | 0 | 0 | 1 | 60 | 0 | 0 | 0 | 25 | 0 | 0 | 86 |
| 3:45 PM | 0 | 0 | 0 | 0 | 1 | 0 | 1 | 0 | 4 | 76 | 0 | 0 | 0 | 23 | 0 | 1 | 106 |
| 4:00 PM | 0 | 0 | 0 | 0 | 1 | 0 | 1 | 0 | 3 | 61 | 0 | 0 | 0 | 22 | 0 | 0 | 88 |
| 4:15 PM | 0 | 0 | 0 | 0 | 0 | 0 | 2 | 0 | 1 | 54 | 0 | 0 | 0 | 35 | 1 | 0 | 93 |
| 4:30 PM | 0 | 0 | 0 | 0 | 1 | 0 | 1 | 0 | 2 | 62 | 0 | 0 | 0 | 30 | 1 | 0 | 97 |
| 4:45 PM | 0 | 0 | 0 | 0 | 1 | 0 | 0 | 0 | 1 | 79 | 0 | 0 | 0 | 27 | 1 | 0 | 109 |
| 5:00 PM | 0 | 0 | 0 | 0 | 1 | 0 | 2 | 0 | 3 | 74 | 0 | 0 | 0 | 33 | 2 | 0 | 115 |
| 5:15 PM | 0 | 0 | 0 | 0 | 3 | 0 | 0 | 0 | 4 | 86 | 0 | 0 | 0 | 34 | 3 | 0 | 130 |
| 5:30 PM | 0 | 0 | 0 | 0 | 1 | 0 | 0 | 0 | 2 | 67 | 0 | 0 | 0 | 22 | 0 | 0 | 92 |
| 5:45 PM | 0 | 0 | 0 | 0 | 0 | 0 | 3 | 0 | 1 | 58 | 0 | 0 | 0 | 16 | 1 | 0 | 79 |
| 6:00 PM | 0 | 0 | 0 | 0 | 2 | 0 | 1 | 0 | 4 | 61 | 0 | 0 | 0 | 32 | 1 | 0 | 101 |
| 6:15 PM | 0 | 0 | 0 | 0 | 0 | 0 | 0 | 0 | 4 | 58 | 0 | 0 | 0 | 18 | 1 | 0 | 81 |
| 6:30 PM | 0 | 0 | 0 | 0 | 1 | 0 | 4 | 0 | 2 | 43 | 0 | 0 | 0 | 29 | 0 | 0 | 79 |
| 6:45 PM | 0 | 0 | 0 | 0 | 1 | 0 | 2 | 0 | 1 | 30 | 0 | 0 | 0 | 25 | 0 | 0 | 59 |
| TOTAL VOLUMES: | NL | NT | NR | NU | SL | ST | SR | SU | EL | ET | ER | EU | WL | WT | WR | WU | TOTAL |
| APPROACH %'s: | 0 | 0 | 0 | 0 | 17 | 0 | 20 | 0 | 42 | 1082 | 0 | 0 | 0 | 562 | 13 | 1 | 1737 |
| | | | | | 45.95% | 0.00% | 54.05% | 0.00% | 3.74% | 96.26% | 0.00% | 0.00% | 0.00% | 97.57% | 2.26% | 0.17% | |
| PEAK HR: | 04:30 PM - 05:30 PM | | | | | | | | | | | | | | | | TOTAL |
| PEAK HR VOL: | 0 | 0 | 0 | 0 | 6 | 0 | 3 | 0 | 10 | 301 | 0 | 0 | 0 | 124 | 7 | 0 | 451 |
| PEAK HR FACTOR: | 0.000 | 0.000 | 0.000 | 0.000 | 0.500 | 0.000 | 0.375 | 0.000 | 0.625 | 0.875 | 0.000 | 0.000 | 0.000 | 0.912 | 0.583 | 0.000 | 0.867 |
| | | | | | | | 0.750 | | | | 0.864 | | | | 0.885 | | |

National Data & Surveying Services Intersection Turning Movement Count

Location: Noah Martin Rd & Old Cornelia Hwy
 City: Lula
 Control: 1-Way Stop (SB)

Project ID: 22-180056-005
 Date: 3/30/2022

Data - Cars

| NS/EW Streets: | Noah Martin Rd | | | | Noah Martin Rd | | | | Old Cornelia Hwy | | | | Old Cornelia Hwy | | | | |
|------------------|---------------------|-------|-------|-------|----------------|-------|--------|-------|------------------|--------|-------|-------|------------------|--------|-------|-------|-------|
| AM | NORTHBOUND | | | | SOUTHBOUND | | | | EASTBOUND | | | | WESTBOUND | | | | TOTAL |
| | NL | NT | NR | NU | SL | ST | SR | SU | EL | ET | ER | EU | WL | WT | WR | WU | |
| 7:00 AM | 0 | 0 | 0 | 0 | 0 | 0 | 2 | 0 | 0 | 10 | 0 | 0 | 0 | 58 | 0 | 0 | 70 |
| 7:15 AM | 0 | 0 | 0 | 0 | 0 | 0 | 0 | 0 | 0 | 11 | 0 | 0 | 0 | 69 | 1 | 0 | 81 |
| 7:30 AM | 0 | 0 | 0 | 0 | 0 | 0 | 3 | 0 | 0 | 18 | 0 | 0 | 0 | 101 | 0 | 0 | 122 |
| 7:45 AM | 0 | 0 | 0 | 0 | 1 | 0 | 2 | 0 | 0 | 15 | 0 | 0 | 0 | 90 | 1 | 0 | 109 |
| 8:00 AM | 0 | 0 | 0 | 0 | 0 | 0 | 1 | 0 | 0 | 27 | 0 | 0 | 0 | 85 | 0 | 0 | 113 |
| 8:15 AM | 0 | 0 | 0 | 0 | 1 | 0 | 2 | 0 | 0 | 28 | 0 | 0 | 0 | 45 | 1 | 0 | 77 |
| 8:30 AM | 0 | 0 | 0 | 0 | 0 | 0 | 0 | 0 | 0 | 11 | 0 | 0 | 0 | 38 | 0 | 0 | 49 |
| 8:45 AM | 0 | 0 | 0 | 0 | 0 | 0 | 1 | 0 | 0 | 10 | 0 | 0 | 0 | 30 | 1 | 0 | 42 |
| 9:00 AM | 0 | 0 | 0 | 0 | 0 | 0 | 0 | 0 | 0 | 12 | 0 | 0 | 0 | 27 | 0 | 0 | 39 |
| 9:15 AM | 0 | 0 | 0 | 0 | 0 | 0 | 1 | 0 | 1 | 15 | 0 | 0 | 0 | 30 | 0 | 0 | 47 |
| 9:30 AM | 0 | 0 | 0 | 0 | 1 | 0 | 1 | 0 | 0 | 13 | 0 | 0 | 0 | 26 | 1 | 0 | 42 |
| 9:45 AM | 0 | 0 | 0 | 0 | 0 | 0 | 1 | 0 | 0 | 11 | 0 | 0 | 0 | 36 | 0 | 0 | 48 |
| TOTAL VOLUMES : | NL | NT | NR | NU | SL | ST | SR | SU | EL | ET | ER | EU | WL | WT | WR | WU | TOTAL |
| APPROACH %'s : | 0 | 0 | 0 | 0 | 3 | 0 | 14 | 0 | 1 | 181 | 0 | 0 | 0 | 635 | 5 | 0 | 839 |
| | | | | | 17.65% | 0.00% | 82.35% | 0.00% | 0.55% | 99.45% | 0.00% | 0.00% | 0.00% | 99.22% | 0.78% | 0.00% | |
| PEAK HR : | 07:15 AM - 08:15 AM | | | | | | | | | | | | | | | | TOTAL |
| PEAK HR VOL : | 0 | 0 | 0 | 0 | 1 | 0 | 6 | 0 | 0 | 71 | 0 | 0 | 0 | 345 | 2 | 0 | 425 |
| PEAK HR FACTOR : | 0.000 | 0.000 | 0.000 | 0.000 | 0.250 | 0.000 | 0.500 | 0.000 | 0.000 | 0.657 | 0.000 | 0.000 | 0.000 | 0.854 | 0.500 | 0.000 | 0.871 |
| | | | | | 0.583 | | | | 0.657 | | | | 0.859 | | | | |
| NOON | NORTHBOUND | | | | SOUTHBOUND | | | | EASTBOUND | | | | WESTBOUND | | | | TOTAL |
| | NL | NT | NR | NU | SL | ST | SR | SU | EL | ET | ER | EU | WL | WT | WR | WU | |
| 10:00 AM | 0 | 0 | 0 | 0 | 0 | 0 | 1 | 0 | 0 | 12 | 0 | 0 | 0 | 23 | 0 | 0 | 36 |
| 10:15 AM | 0 | 0 | 0 | 0 | 0 | 0 | 1 | 0 | 0 | 19 | 0 | 0 | 0 | 20 | 1 | 0 | 41 |
| 10:30 AM | 0 | 0 | 0 | 0 | 1 | 0 | 1 | 0 | 0 | 19 | 0 | 0 | 0 | 18 | 0 | 0 | 39 |
| 10:45 AM | 0 | 0 | 0 | 0 | 1 | 0 | 2 | 0 | 1 | 17 | 0 | 0 | 0 | 23 | 2 | 0 | 46 |
| 11:00 AM | 0 | 0 | 0 | 0 | 1 | 0 | 1 | 0 | 0 | 18 | 0 | 0 | 0 | 15 | 0 | 0 | 35 |
| 11:15 AM | 0 | 0 | 0 | 0 | 0 | 0 | 0 | 0 | 0 | 26 | 0 | 0 | 0 | 20 | 1 | 0 | 47 |
| 11:30 AM | 0 | 0 | 0 | 0 | 1 | 0 | 0 | 0 | 1 | 29 | 0 | 0 | 0 | 20 | 0 | 0 | 51 |
| 11:45 AM | 0 | 0 | 0 | 0 | 1 | 0 | 1 | 0 | 0 | 17 | 0 | 0 | 0 | 22 | 1 | 0 | 42 |
| 12:00 PM | 0 | 0 | 0 | 0 | 1 | 0 | 1 | 0 | 2 | 27 | 0 | 0 | 0 | 15 | 0 | 0 | 46 |
| 12:15 PM | 0 | 0 | 0 | 0 | 0 | 0 | 2 | 0 | 2 | 24 | 0 | 0 | 0 | 25 | 0 | 0 | 53 |
| 12:30 PM | 0 | 0 | 0 | 0 | 0 | 0 | 1 | 0 | 0 | 26 | 0 | 0 | 0 | 24 | 0 | 0 | 51 |
| 12:45 PM | 0 | 0 | 0 | 0 | 0 | 0 | 4 | 0 | 1 | 36 | 0 | 0 | 0 | 23 | 0 | 0 | 64 |
| 1:00 PM | 0 | 0 | 0 | 0 | 1 | 0 | 1 | 0 | 0 | 28 | 0 | 0 | 0 | 21 | 1 | 0 | 52 |
| 1:15 PM | 0 | 0 | 0 | 0 | 0 | 0 | 0 | 0 | 0 | 20 | 0 | 0 | 0 | 25 | 0 | 0 | 45 |
| 1:30 PM | 0 | 0 | 0 | 0 | 1 | 0 | 1 | 0 | 2 | 25 | 0 | 0 | 0 | 17 | 1 | 0 | 47 |
| 1:45 PM | 0 | 0 | 0 | 0 | 1 | 0 | 2 | 0 | 1 | 45 | 0 | 0 | 0 | 16 | 1 | 0 | 66 |
| TOTAL VOLUMES : | NL | NT | NR | NU | SL | ST | SR | SU | EL | ET | ER | EU | WL | WT | WR | WU | TOTAL |
| APPROACH %'s : | 0 | 0 | 0 | 0 | 9 | 0 | 19 | 0 | 10 | 388 | 0 | 0 | 0 | 327 | 8 | 0 | 761 |
| | | | | | 32.14% | 0.00% | 67.86% | 0.00% | 2.51% | 97.49% | 0.00% | 0.00% | 0.00% | 97.61% | 2.39% | 0.00% | |
| PEAK HR : | 12:15 PM - 01:15 PM | | | | | | | | | | | | | | | | TOTAL |
| PEAK HR VOL : | 0 | 0 | 0 | 0 | 1 | 0 | 8 | 0 | 3 | 114 | 0 | 0 | 0 | 93 | 1 | 0 | 220 |
| PEAK HR FACTOR : | 0.000 | 0.000 | 0.000 | 0.000 | 0.250 | 0.000 | 0.500 | 0.000 | 0.375 | 0.792 | 0.000 | 0.000 | 0.000 | 0.930 | 0.250 | 0.000 | 0.859 |
| | | | | | 0.563 | | | | 0.791 | | | | 0.940 | | | | |
| PM | NORTHBOUND | | | | SOUTHBOUND | | | | EASTBOUND | | | | WESTBOUND | | | | TOTAL |
| | NL | NT | NR | NU | SL | ST | SR | SU | EL | ET | ER | EU | WL | WT | WR | WU | |
| 2:00 PM | 0 | 0 | 0 | 0 | 0 | 0 | 0 | 0 | 0 | 20 | 0 | 0 | 0 | 25 | 0 | 0 | 45 |
| 2:15 PM | 0 | 0 | 0 | 0 | 1 | 0 | 0 | 0 | 1 | 38 | 0 | 0 | 0 | 22 | 0 | 0 | 62 |
| 2:30 PM | 0 | 0 | 0 | 0 | 1 | 0 | 1 | 0 | 2 | 29 | 0 | 0 | 0 | 37 | 0 | 0 | 70 |
| 2:45 PM | 0 | 0 | 0 | 0 | 2 | 0 | 0 | 0 | 0 | 29 | 0 | 0 | 0 | 36 | 0 | 0 | 67 |
| 3:00 PM | 0 | 0 | 0 | 0 | 0 | 0 | 1 | 0 | 1 | 36 | 0 | 0 | 0 | 28 | 1 | 0 | 67 |
| 3:15 PM | 0 | 0 | 0 | 0 | 0 | 0 | 1 | 0 | 2 | 53 | 0 | 0 | 0 | 26 | 1 | 0 | 83 |
| 3:30 PM | 0 | 0 | 0 | 0 | 0 | 0 | 0 | 0 | 1 | 55 | 0 | 0 | 0 | 25 | 0 | 0 | 81 |
| 3:45 PM | 0 | 0 | 0 | 0 | 1 | 0 | 0 | 0 | 4 | 71 | 0 | 0 | 0 | 22 | 0 | 1 | 99 |
| 4:00 PM | 0 | 0 | 0 | 0 | 1 | 0 | 1 | 0 | 3 | 58 | 0 | 0 | 0 | 20 | 0 | 0 | 83 |
| 4:15 PM | 0 | 0 | 0 | 0 | 0 | 0 | 2 | 0 | 1 | 53 | 0 | 0 | 0 | 35 | 1 | 0 | 92 |
| 4:30 PM | 0 | 0 | 0 | 0 | 1 | 0 | 1 | 0 | 2 | 59 | 0 | 0 | 0 | 26 | 1 | 0 | 90 |
| 4:45 PM | 0 | 0 | 0 | 0 | 1 | 0 | 0 | 0 | 1 | 76 | 0 | 0 | 0 | 26 | 1 | 0 | 105 |
| 5:00 PM | 0 | 0 | 0 | 0 | 1 | 0 | 2 | 0 | 3 | 73 | 0 | 0 | 0 | 33 | 2 | 0 | 114 |
| 5:15 PM | 0 | 0 | 0 | 0 | 3 | 0 | 0 | 0 | 4 | 86 | 0 | 0 | 0 | 33 | 3 | 0 | 129 |
| 5:30 PM | 0 | 0 | 0 | 0 | 1 | 0 | 0 | 0 | 1 | 63 | 0 | 0 | 0 | 21 | 0 | 0 | 86 |
| 5:45 PM | 0 | 0 | 0 | 0 | 0 | 0 | 3 | 0 | 1 | 57 | 0 | 0 | 0 | 16 | 1 | 0 | 78 |
| 6:00 PM | 0 | 0 | 0 | 0 | 2 | 0 | 0 | 0 | 4 | 60 | 0 | 0 | 0 | 31 | 1 | 0 | 98 |
| 6:15 PM | 0 | 0 | 0 | 0 | 0 | 0 | 0 | 0 | 4 | 58 | 0 | 0 | 0 | 18 | 1 | 0 | 81 |
| 6:30 PM | 0 | 0 | 0 | 0 | 1 | 0 | 3 | 0 | 2 | 42 | 0 | 0 | 0 | 29 | 0 | 0 | 77 |
| 6:45 PM | 0 | 0 | 0 | 0 | 0 | 0 | 2 | 0 | 1 | 29 | 0 | 0 | 0 | 25 | 0 | 0 | 57 |
| TOTAL VOLUMES : | NL | NT | NR | NU | SL | ST | SR | SU | EL | ET | ER | EU | WL | WT | WR | WU | TOTAL |
| APPROACH %'s : | 0 | 0 | 0 | 0 | 16 | 0 | 17 | 0 | 38 | 1045 | 0 | 0 | 0 | 534 | 13 | 1 | 1664 |
| | | | | | 48.48% | 0.00% | 51.52% | 0.00% | 3.51% | 96.49% | 0.00% | 0.00% | 0.00% | 97.45% | 2.37% | 0.18% | |
| PEAK HR : | 04:30 PM - 05:30 PM | | | | | | | | | | | | | | | | TOTAL |
| PEAK HR VOL : | 0 | 0 | 0 | 0 | 6 | 0 | 3 | 0 | 10 | 294 | 0 | 0 | 0 | 118 | 7 | 0 | 438 |
| PEAK HR FACTOR : | 0.000 | 0.000 | 0.000 | 0.000 | 0.500 | 0.000 | 0.375 | 0.000 | 0.625 | 0.855 | 0.000 | 0.000 | 0.000 | 0.894 | 0.583 | 0.000 | 0.849 |
| | | | | | 0.750 | | | | 0.844 | | | | 0.868 | | | | |

National Data & Surveying Services Intersection Turning Movement Count

Location: Noah Martin Rd & Old Cornelia Hwy
 City: Lula
 Control: 1-Way Stop (SB)

Project ID: 22-180056-005
 Date: 3/30/2022

Data - HT

| NS/EW Streets: | Noah Martin Rd | | | | Noah Martin Rd | | | | Old Cornelia Hwy | | | | Old Cornelia Hwy | | | | | |
|-----------------|---------------------|-------|-------|-------|----------------|-------|-------|-------|------------------|-------|-------|-------|------------------|-------|-------|-------|-------|---|
| AM | NORTHBOUND | | | | SOUTHBOUND | | | | EASTBOUND | | | | WESTBOUND | | | | TOTAL | |
| | NL | NT | NR | NU | SL | ST | SR | SU | EL | ET | ER | EU | WL | WT | WR | WU | | |
| 7:00 AM | 0 | 0 | 0 | 0 | 0 | 0 | 0 | 0 | 0 | 0 | 0 | 0 | 0 | 0 | 0 | 0 | 0 | 0 |
| 7:15 AM | 0 | 0 | 0 | 0 | 0 | 1 | 0 | 0 | 0 | 0 | 1 | 0 | 0 | 0 | 2 | 0 | 0 | 3 |
| 7:30 AM | 0 | 0 | 0 | 0 | 0 | 0 | 1 | 0 | 0 | 0 | 1 | 0 | 0 | 0 | 0 | 0 | 2 | |
| 7:45 AM | 0 | 0 | 0 | 0 | 0 | 0 | 0 | 0 | 0 | 0 | 0 | 0 | 0 | 3 | 0 | 0 | 3 | |
| 8:00 AM | 0 | 0 | 0 | 0 | 0 | 0 | 0 | 0 | 0 | 5 | 0 | 0 | 0 | 5 | 0 | 0 | 10 | |
| 8:15 AM | 0 | 0 | 0 | 0 | 0 | 0 | 0 | 0 | 0 | 6 | 0 | 0 | 0 | 0 | 0 | 0 | 6 | |
| 8:30 AM | 0 | 0 | 0 | 0 | 0 | 0 | 0 | 0 | 0 | 0 | 0 | 0 | 0 | 0 | 0 | 0 | 0 | |
| 8:45 AM | 0 | 0 | 0 | 0 | 0 | 0 | 0 | 0 | 0 | 1 | 0 | 0 | 0 | 2 | 0 | 0 | 3 | |
| 9:00 AM | 0 | 0 | 0 | 0 | 0 | 0 | 0 | 0 | 0 | 3 | 0 | 0 | 0 | 1 | 0 | 0 | 4 | |
| 9:15 AM | 0 | 0 | 0 | 0 | 0 | 0 | 0 | 0 | 0 | 1 | 0 | 0 | 0 | 2 | 0 | 0 | 3 | |
| 9:30 AM | 0 | 0 | 0 | 0 | 0 | 0 | 0 | 0 | 0 | 3 | 0 | 0 | 0 | 0 | 0 | 0 | 3 | |
| 9:45 AM | 0 | 0 | 0 | 0 | 0 | 0 | 0 | 0 | 0 | 2 | 0 | 0 | 0 | 2 | 0 | 0 | 4 | |
| TOTAL VOLUMES: | NL | NT | NR | NU | SL | ST | SR | SU | EL | ET | ER | EU | WL | WT | WR | WU | TOTAL | |
| APPROACH %'s: | 0 | 0 | 0 | 0 | 0 | 0 | 1 | 0 | 0 | 23 | 0 | 0 | 0 | 17 | 0 | 0 | 41 | |
| PEAK HR: | 07:15 AM - 08:15 AM | | | | 0.00% | | | | 100.00% | | | | 0.00% | | | | | |
| PEAK HR VOL: | 0 | 0 | 0 | 0 | 0 | 0 | 1 | 0 | 0 | 7 | 0 | 0 | 0 | 10 | 0 | 0 | 18 | |
| PEAK HR FACTOR: | 0.000 | 0.000 | 0.000 | 0.000 | 0.000 | 0.000 | 0.250 | 0.000 | 0.000 | 0.350 | 0.000 | 0.000 | 0.000 | 0.500 | 0.000 | 0.000 | 0.450 | |
| | | | | | | | 0.250 | | | | 0.350 | | | | 0.500 | | | |
| NOON | NORTHBOUND | | | | SOUTHBOUND | | | | EASTBOUND | | | | WESTBOUND | | | | TOTAL | |
| | NL | NT | NR | NU | SL | ST | SR | SU | EL | ET | ER | EU | WL | WT | WR | WU | | |
| 10:00 AM | 0 | 0 | 0 | 0 | 0 | 0 | 0 | 0 | 0 | 0 | 0 | 0 | 1 | 0 | 0 | 0 | 1 | |
| 10:15 AM | 0 | 0 | 0 | 0 | 0 | 0 | 0 | 0 | 0 | 1 | 0 | 0 | 0 | 1 | 0 | 0 | 2 | |
| 10:30 AM | 0 | 0 | 0 | 0 | 0 | 0 | 1 | 0 | 0 | 3 | 0 | 0 | 0 | 2 | 0 | 0 | 6 | |
| 10:45 AM | 0 | 0 | 0 | 0 | 0 | 0 | 0 | 0 | 0 | 0 | 0 | 0 | 2 | 0 | 0 | 0 | 2 | |
| 11:00 AM | 0 | 0 | 0 | 0 | 0 | 0 | 0 | 0 | 0 | 1 | 0 | 0 | 0 | 1 | 0 | 0 | 2 | |
| 11:15 AM | 0 | 0 | 0 | 0 | 0 | 0 | 0 | 0 | 0 | 2 | 0 | 0 | 0 | 3 | 0 | 0 | 5 | |
| 11:30 AM | 0 | 0 | 0 | 0 | 0 | 0 | 0 | 0 | 0 | 0 | 0 | 0 | 3 | 0 | 0 | 0 | 3 | |
| 11:45 AM | 0 | 0 | 0 | 0 | 0 | 0 | 1 | 0 | 0 | 0 | 0 | 0 | 2 | 0 | 0 | 0 | 3 | |
| 12:00 PM | 0 | 0 | 0 | 0 | 0 | 0 | 0 | 0 | 0 | 2 | 0 | 0 | 0 | 5 | 0 | 0 | 7 | |
| 12:15 PM | 0 | 0 | 0 | 0 | 0 | 0 | 0 | 0 | 0 | 0 | 0 | 0 | 1 | 0 | 0 | 0 | 1 | |
| 12:30 PM | 0 | 0 | 0 | 0 | 0 | 0 | 0 | 0 | 0 | 2 | 0 | 0 | 0 | 2 | 0 | 0 | 4 | |
| 12:45 PM | 0 | 0 | 0 | 0 | 0 | 0 | 0 | 0 | 0 | 2 | 0 | 0 | 0 | 2 | 0 | 0 | 4 | |
| 1:00 PM | 0 | 0 | 0 | 0 | 0 | 0 | 0 | 0 | 1 | 1 | 0 | 0 | 0 | 2 | 0 | 0 | 4 | |
| 1:15 PM | 0 | 0 | 0 | 0 | 1 | 0 | 0 | 0 | 0 | 2 | 0 | 0 | 0 | 1 | 0 | 0 | 4 | |
| 1:30 PM | 0 | 0 | 0 | 0 | 0 | 0 | 0 | 0 | 0 | 0 | 0 | 0 | 0 | 5 | 0 | 0 | 5 | |
| 1:45 PM | 0 | 0 | 0 | 0 | 0 | 0 | 0 | 0 | 0 | 2 | 0 | 0 | 0 | 2 | 0 | 0 | 4 | |
| TOTAL VOLUMES: | NL | NT | NR | NU | SL | ST | SR | SU | EL | ET | ER | EU | WL | WT | WR | WU | TOTAL | |
| APPROACH %'s: | 0 | 0 | 0 | 0 | 1 | 0 | 2 | 0 | 1 | 18 | 0 | 0 | 0 | 35 | 0 | 0 | 57 | |
| PEAK HR: | 12:15 PM - 01:15 PM | | | | 33.33% | | | | 66.67% | | | | 0.00% | | | | | |
| PEAK HR VOL: | 0 | 0 | 0 | 0 | 0 | 0 | 0 | 0 | 1 | 5 | 0 | 0 | 0 | 7 | 0 | 0 | 13 | |
| PEAK HR FACTOR: | 0.000 | 0.000 | 0.000 | 0.000 | 0.000 | 0.000 | 0.000 | 0.000 | 0.250 | 0.625 | 0.000 | 0.000 | 0.000 | 0.875 | 0.000 | 0.000 | 0.813 | |
| | | | | | | | | | | | 0.750 | | | | 0.875 | | | |
| PM | NORTHBOUND | | | | SOUTHBOUND | | | | EASTBOUND | | | | WESTBOUND | | | | TOTAL | |
| | NL | NT | NR | NU | SL | ST | SR | SU | EL | ET | ER | EU | WL | WT | WR | WU | | |
| 2:00 PM | 0 | 0 | 0 | 0 | 0 | 0 | 0 | 0 | 0 | 3 | 0 | 0 | 0 | 2 | 0 | 0 | 5 | |
| 2:15 PM | 0 | 0 | 0 | 0 | 0 | 0 | 0 | 0 | 1 | 0 | 0 | 0 | 0 | 3 | 0 | 0 | 4 | |
| 2:30 PM | 0 | 0 | 0 | 0 | 0 | 0 | 0 | 0 | 1 | 0 | 0 | 0 | 0 | 2 | 0 | 0 | 3 | |
| 2:45 PM | 0 | 0 | 0 | 0 | 0 | 0 | 0 | 0 | 0 | 3 | 0 | 0 | 0 | 4 | 0 | 0 | 7 | |
| 3:00 PM | 0 | 0 | 0 | 0 | 0 | 0 | 0 | 0 | 0 | 1 | 0 | 0 | 0 | 6 | 0 | 0 | 7 | |
| 3:15 PM | 0 | 0 | 0 | 0 | 0 | 0 | 0 | 0 | 1 | 1 | 0 | 0 | 0 | 0 | 0 | 0 | 2 | |
| 3:30 PM | 0 | 0 | 0 | 0 | 0 | 0 | 0 | 0 | 0 | 5 | 0 | 0 | 0 | 0 | 0 | 0 | 5 | |
| 3:45 PM | 0 | 0 | 0 | 0 | 0 | 0 | 1 | 0 | 0 | 5 | 0 | 0 | 0 | 1 | 0 | 0 | 7 | |
| 4:00 PM | 0 | 0 | 0 | 0 | 0 | 0 | 0 | 0 | 0 | 3 | 0 | 0 | 0 | 2 | 0 | 0 | 5 | |
| 4:15 PM | 0 | 0 | 0 | 0 | 0 | 0 | 0 | 0 | 0 | 1 | 0 | 0 | 0 | 0 | 0 | 0 | 1 | |
| 4:30 PM | 0 | 0 | 0 | 0 | 0 | 0 | 0 | 0 | 0 | 3 | 0 | 0 | 0 | 4 | 0 | 0 | 7 | |
| 4:45 PM | 0 | 0 | 0 | 0 | 0 | 0 | 0 | 0 | 0 | 3 | 0 | 0 | 0 | 1 | 0 | 0 | 4 | |
| 5:00 PM | 0 | 0 | 0 | 0 | 0 | 0 | 0 | 0 | 0 | 1 | 0 | 0 | 0 | 0 | 0 | 0 | 1 | |
| 5:15 PM | 0 | 0 | 0 | 0 | 0 | 0 | 0 | 0 | 0 | 0 | 0 | 0 | 0 | 1 | 0 | 0 | 1 | |
| 5:30 PM | 0 | 0 | 0 | 0 | 0 | 0 | 0 | 0 | 1 | 4 | 0 | 0 | 0 | 1 | 0 | 0 | 6 | |
| 5:45 PM | 0 | 0 | 0 | 0 | 0 | 0 | 0 | 0 | 0 | 1 | 0 | 0 | 0 | 0 | 0 | 0 | 1 | |
| 6:00 PM | 0 | 0 | 0 | 0 | 0 | 0 | 1 | 0 | 0 | 1 | 0 | 0 | 0 | 1 | 0 | 0 | 3 | |
| 6:15 PM | 0 | 0 | 0 | 0 | 0 | 0 | 0 | 0 | 0 | 0 | 0 | 0 | 0 | 0 | 0 | 0 | 0 | |
| 6:30 PM | 0 | 0 | 0 | 0 | 0 | 0 | 1 | 0 | 0 | 1 | 0 | 0 | 0 | 0 | 0 | 0 | 2 | |
| 6:45 PM | 0 | 0 | 0 | 0 | 1 | 0 | 0 | 0 | 0 | 1 | 0 | 0 | 0 | 0 | 0 | 0 | 2 | |
| TOTAL VOLUMES: | NL | NT | NR | NU | SL | ST | SR | SU | EL | ET | ER | EU | WL | WT | WR | WU | TOTAL | |
| APPROACH %'s: | 0 | 0 | 0 | 0 | 1 | 0 | 3 | 0 | 4 | 37 | 0 | 0 | 0 | 28 | 0 | 0 | 73 | |
| PEAK HR: | 04:30 PM - 05:30 PM | | | | 25.00% | | | | 75.00% | | | | 0.00% | | | | | |
| PEAK HR VOL: | 0 | 0 | 0 | 0 | 0 | 0 | 0 | 0 | 0 | 7 | 0 | 0 | 0 | 6 | 0 | 0 | 13 | |
| PEAK HR FACTOR: | 0.000 | 0.000 | 0.000 | 0.000 | 0.000 | 0.000 | 0.000 | 0.000 | 0.000 | 0.583 | 0.000 | 0.000 | 0.000 | 0.375 | 0.000 | 0.000 | 0.464 | |
| | | | | | | | | | | | 0.583 | | | | 0.375 | | | |

National Data & Surveying Services Intersection Turning Movement Count

Location: Noah Martin Rd & Old Cornelia Hwy
 City: Lula
 Control: 1-Way Stop (SB)

Project ID: 22-180056-005
 Date: 3/30/2022

Data - Bikes

| NS/EW Streets: | Noah Martin Rd | | | | Noah Martin Rd | | | | Old Cornelia Hwy | | | | Old Cornelia Hwy | | | | |
|-----------------------------------|---------------------|-------|-------|-------|----------------|-------|-------|-------|------------------|-------|-------|-------|------------------|-------|-------|-------|-------|
| AM | NORTHBOUND | | | | SOUTHBOUND | | | | EASTBOUND | | | | WESTBOUND | | | | TOTAL |
| | NL | NT | NR | NU | SL | ST | SR | SU | EL | ET | ER | EU | WL | WT | WR | WU | |
| 7:00 AM | 0 | 0 | 0 | 0 | 0 | 0 | 0 | 0 | 0 | 0 | 0 | 0 | 0 | 0 | 0 | 0 | 0 |
| 7:15 AM | 0 | 0 | 0 | 0 | 0 | 0 | 0 | 0 | 0 | 0 | 0 | 0 | 0 | 0 | 0 | 0 | 0 |
| 7:30 AM | 0 | 0 | 0 | 0 | 0 | 0 | 0 | 0 | 0 | 0 | 0 | 0 | 0 | 0 | 0 | 0 | 0 |
| 7:45 AM | 0 | 0 | 0 | 0 | 0 | 0 | 0 | 0 | 0 | 0 | 0 | 0 | 0 | 0 | 0 | 0 | 0 |
| 8:00 AM | 0 | 0 | 0 | 0 | 0 | 0 | 0 | 0 | 0 | 0 | 0 | 0 | 0 | 0 | 0 | 0 | 0 |
| 8:15 AM | 0 | 0 | 0 | 0 | 0 | 0 | 0 | 0 | 0 | 0 | 0 | 0 | 0 | 0 | 0 | 0 | 0 |
| 8:30 AM | 0 | 0 | 0 | 0 | 0 | 0 | 0 | 0 | 0 | 0 | 0 | 0 | 0 | 0 | 0 | 0 | 0 |
| 8:45 AM | 0 | 0 | 0 | 0 | 0 | 0 | 0 | 0 | 0 | 0 | 0 | 0 | 0 | 0 | 0 | 0 | 0 |
| 9:00 AM | 0 | 0 | 0 | 0 | 0 | 0 | 0 | 0 | 0 | 0 | 0 | 0 | 0 | 0 | 0 | 0 | 0 |
| 9:15 AM | 0 | 0 | 0 | 0 | 0 | 0 | 0 | 0 | 0 | 0 | 0 | 0 | 0 | 0 | 0 | 0 | 0 |
| 9:30 AM | 0 | 0 | 0 | 0 | 0 | 0 | 0 | 0 | 0 | 0 | 0 | 0 | 0 | 0 | 0 | 0 | 0 |
| 9:45 AM | 0 | 0 | 0 | 0 | 0 | 0 | 0 | 0 | 0 | 0 | 0 | 0 | 0 | 0 | 0 | 0 | 0 |
| TOTAL VOLUMES : APPROACH %'s : | NL | NT | NR | NU | SL | ST | SR | SU | EL | ET | ER | EU | WL | WT | WR | WU | TOTAL |
| | 0 | 0 | 0 | 0 | 0 | 0 | 0 | 0 | 0 | 0 | 0 | 0 | 0 | 0 | 0 | 0 | 0 |
| PEAK HR : | 07:15 AM - 08:15 AM | | | | | | | | | | | | | | | | TOTAL |
| PEAK HR VOL : | 0 | 0 | 0 | 0 | 0 | 0 | 0 | 0 | 0 | 0 | 0 | 0 | 0 | 0 | 0 | 0 | 0 |
| PEAK HR FACTOR : | 0.000 | 0.000 | 0.000 | 0.000 | 0.000 | 0.000 | 0.000 | 0.000 | 0.000 | 0.000 | 0.000 | 0.000 | 0.000 | 0.000 | 0.000 | 0.000 | 0 |
| | | | | | | | | | | | | | | | | | |
| NOON | NORTHBOUND | | | | SOUTHBOUND | | | | EASTBOUND | | | | WESTBOUND | | | | TOTAL |
| | NL | NT | NR | NU | SL | ST | SR | SU | EL | ET | ER | EU | WL | WT | WR | WU | |
| 10:00 AM | 0 | 0 | 0 | 0 | 0 | 0 | 0 | 0 | 0 | 0 | 0 | 0 | 0 | 0 | 0 | 0 | 0 |
| 10:15 AM | 0 | 0 | 0 | 0 | 0 | 0 | 0 | 0 | 0 | 0 | 0 | 0 | 0 | 0 | 0 | 0 | 0 |
| 10:30 AM | 0 | 0 | 0 | 0 | 0 | 0 | 0 | 0 | 0 | 0 | 0 | 0 | 0 | 0 | 0 | 0 | 0 |
| 10:45 AM | 0 | 0 | 0 | 0 | 0 | 0 | 0 | 0 | 0 | 0 | 0 | 0 | 0 | 0 | 0 | 0 | 0 |
| 11:00 AM | 0 | 0 | 0 | 0 | 0 | 0 | 0 | 0 | 0 | 0 | 0 | 0 | 0 | 0 | 0 | 0 | 0 |
| 11:15 AM | 0 | 0 | 0 | 0 | 0 | 0 | 0 | 0 | 0 | 0 | 0 | 0 | 0 | 0 | 0 | 0 | 0 |
| 11:30 AM | 0 | 0 | 0 | 0 | 0 | 0 | 0 | 0 | 0 | 0 | 0 | 0 | 0 | 0 | 0 | 0 | 0 |
| 11:45 AM | 0 | 0 | 0 | 0 | 0 | 0 | 0 | 0 | 0 | 0 | 0 | 0 | 0 | 0 | 0 | 0 | 0 |
| 12:00 PM | 0 | 0 | 0 | 0 | 0 | 0 | 0 | 0 | 0 | 0 | 0 | 0 | 0 | 0 | 0 | 0 | 0 |
| 12:15 PM | 0 | 0 | 0 | 0 | 0 | 0 | 0 | 0 | 0 | 0 | 0 | 0 | 0 | 0 | 0 | 0 | 0 |
| 12:30 PM | 0 | 0 | 0 | 0 | 0 | 0 | 0 | 0 | 0 | 0 | 0 | 0 | 0 | 0 | 0 | 0 | 0 |
| 12:45 PM | 0 | 0 | 0 | 0 | 0 | 0 | 0 | 0 | 0 | 0 | 0 | 0 | 0 | 0 | 0 | 0 | 0 |
| 1:00 PM | 0 | 0 | 0 | 0 | 0 | 0 | 0 | 0 | 0 | 0 | 0 | 0 | 0 | 0 | 0 | 0 | 0 |
| 1:15 PM | 0 | 0 | 0 | 0 | 0 | 0 | 0 | 0 | 0 | 0 | 0 | 0 | 0 | 0 | 0 | 0 | 0 |
| 1:30 PM | 0 | 0 | 0 | 0 | 0 | 0 | 0 | 0 | 0 | 0 | 0 | 0 | 0 | 0 | 0 | 0 | 0 |
| 1:45 PM | 0 | 0 | 0 | 0 | 0 | 0 | 0 | 0 | 0 | 0 | 0 | 0 | 0 | 0 | 0 | 0 | 0 |
| TOTAL VOLUMES : APPROACH %'s : | NL | NT | NR | NU | SL | ST | SR | SU | EL | ET | ER | EU | WL | WT | WR | WU | TOTAL |
| | 0 | 0 | 0 | 0 | 0 | 0 | 0 | 0 | 0 | 0 | 0 | 0 | 0 | 0 | 0 | 0 | 0 |
| PEAK HR : | 12:15 PM - 01:15 PM | | | | | | | | | | | | | | | | TOTAL |
| PEAK HR VOL : | 0 | 0 | 0 | 0 | 0 | 0 | 0 | 0 | 0 | 0 | 0 | 0 | 0 | 0 | 0 | 0 | 0 |
| PEAK HR FACTOR : | 0.000 | 0.000 | 0.000 | 0.000 | 0.000 | 0.000 | 0.000 | 0.000 | 0.000 | 0.000 | 0.000 | 0.000 | 0.000 | 0.000 | 0.000 | 0.000 | 0 |
| | | | | | | | | | | | | | | | | | |
| PM | NORTHBOUND | | | | SOUTHBOUND | | | | EASTBOUND | | | | WESTBOUND | | | | TOTAL |
| | NL | NT | NR | NU | SL | ST | SR | SU | EL | ET | ER | EU | WL | WT | WR | WU | |
| 2:00 PM | 0 | 0 | 0 | 0 | 0 | 0 | 0 | 0 | 0 | 0 | 0 | 0 | 0 | 0 | 0 | 0 | 0 |
| 2:15 PM | 0 | 0 | 0 | 0 | 0 | 0 | 0 | 0 | 0 | 0 | 0 | 0 | 0 | 0 | 0 | 0 | 0 |
| 2:30 PM | 0 | 0 | 0 | 0 | 0 | 0 | 0 | 0 | 0 | 0 | 0 | 0 | 0 | 0 | 0 | 0 | 0 |
| 2:45 PM | 0 | 0 | 0 | 0 | 0 | 0 | 0 | 0 | 0 | 0 | 0 | 0 | 0 | 0 | 0 | 0 | 0 |
| 3:00 PM | 0 | 0 | 0 | 0 | 0 | 0 | 0 | 0 | 0 | 0 | 0 | 0 | 0 | 0 | 0 | 0 | 0 |
| 3:15 PM | 0 | 0 | 0 | 0 | 0 | 0 | 0 | 0 | 0 | 0 | 0 | 0 | 0 | 0 | 0 | 0 | 0 |
| 3:30 PM | 0 | 0 | 0 | 0 | 0 | 0 | 0 | 0 | 0 | 0 | 0 | 0 | 0 | 0 | 0 | 0 | 0 |
| 3:45 PM | 0 | 0 | 0 | 0 | 0 | 0 | 0 | 0 | 0 | 0 | 0 | 0 | 0 | 0 | 0 | 0 | 0 |
| 4:00 PM | 0 | 0 | 0 | 0 | 0 | 0 | 0 | 0 | 0 | 0 | 0 | 0 | 0 | 0 | 0 | 0 | 0 |
| 4:15 PM | 0 | 0 | 0 | 0 | 0 | 0 | 0 | 0 | 0 | 0 | 0 | 0 | 0 | 0 | 0 | 0 | 0 |
| 4:30 PM | 0 | 0 | 0 | 0 | 0 | 0 | 0 | 0 | 0 | 0 | 0 | 0 | 0 | 0 | 0 | 0 | 0 |
| 4:45 PM | 0 | 0 | 0 | 0 | 0 | 0 | 0 | 0 | 0 | 0 | 0 | 0 | 0 | 0 | 0 | 0 | 0 |
| 5:00 PM | 0 | 0 | 0 | 0 | 0 | 0 | 0 | 0 | 0 | 0 | 0 | 0 | 0 | 0 | 0 | 0 | 0 |
| 5:15 PM | 0 | 0 | 0 | 0 | 0 | 0 | 0 | 0 | 0 | 0 | 0 | 0 | 0 | 0 | 0 | 0 | 0 |
| 5:30 PM | 0 | 0 | 0 | 0 | 0 | 0 | 0 | 0 | 0 | 0 | 0 | 0 | 0 | 0 | 0 | 0 | 0 |
| 5:45 PM | 0 | 0 | 0 | 0 | 0 | 0 | 0 | 0 | 0 | 0 | 0 | 0 | 0 | 0 | 0 | 0 | 0 |
| 6:00 PM | 0 | 0 | 0 | 0 | 0 | 0 | 0 | 0 | 0 | 0 | 0 | 0 | 0 | 0 | 0 | 0 | 0 |
| 6:15 PM | 0 | 0 | 0 | 0 | 0 | 0 | 0 | 0 | 0 | 0 | 0 | 0 | 0 | 0 | 0 | 0 | 0 |
| 6:30 PM | 0 | 0 | 0 | 0 | 0 | 0 | 0 | 0 | 0 | 0 | 0 | 0 | 0 | 0 | 0 | 0 | 0 |
| 6:45 PM | 0 | 0 | 0 | 0 | 0 | 0 | 0 | 0 | 0 | 0 | 0 | 0 | 0 | 0 | 0 | 0 | 0 |
| TOTAL VOLUMES : APPROACH %'s : | NL | NT | NR | NU | SL | ST | SR | SU | EL | ET | ER | EU | WL | WT | WR | WU | TOTAL |
| | 0 | 0 | 0 | 0 | 0 | 0 | 0 | 0 | 0 | 0 | 0 | 0 | 0 | 0 | 0 | 0 | 0 |
| PEAK HR : | 04:30 PM - 05:30 PM | | | | | | | | | | | | | | | | TOTAL |
| PEAK HR VOL : | 0 | 0 | 0 | 0 | 0 | 0 | 0 | 0 | 0 | 0 | 0 | 0 | 0 | 0 | 0 | 0 | 0 |
| PEAK HR FACTOR : | 0.000 | 0.000 | 0.000 | 0.000 | 0.000 | 0.000 | 0.000 | 0.000 | 0.000 | 0.000 | 0.000 | 0.000 | 0.000 | 0.000 | 0.000 | 0.000 | 0 |

Noah Martin Rd & Old Cornelia Hwy

Peak Hour Turning Movement Count

ID: 22-180056-005
City: Lula

Day: Wednesday
Date: 3/30/2022

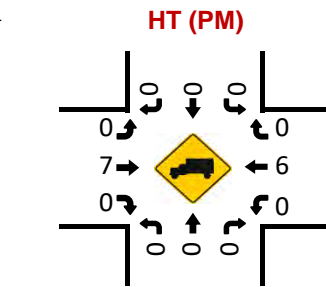
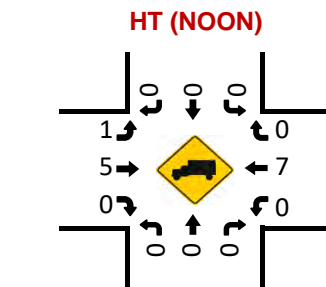
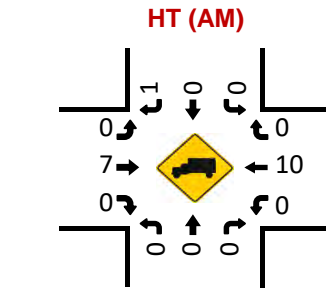
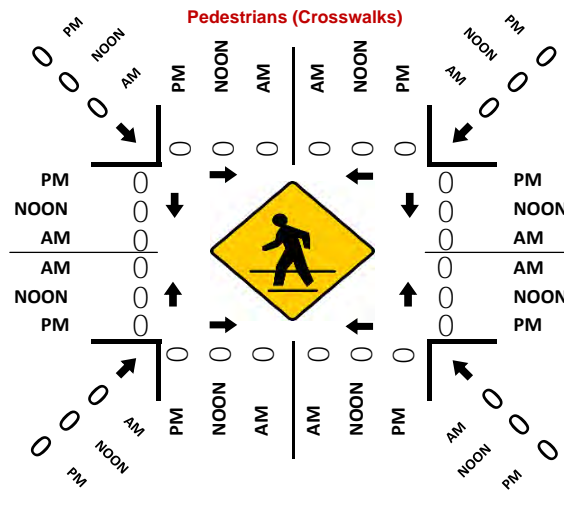
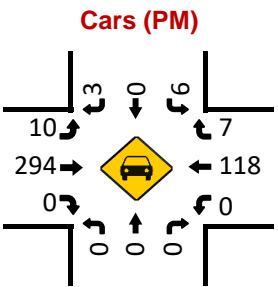
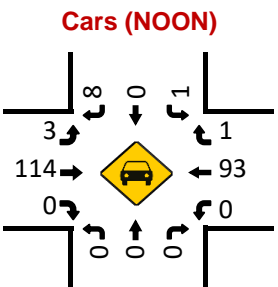
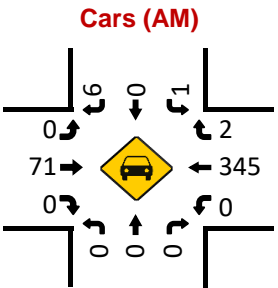
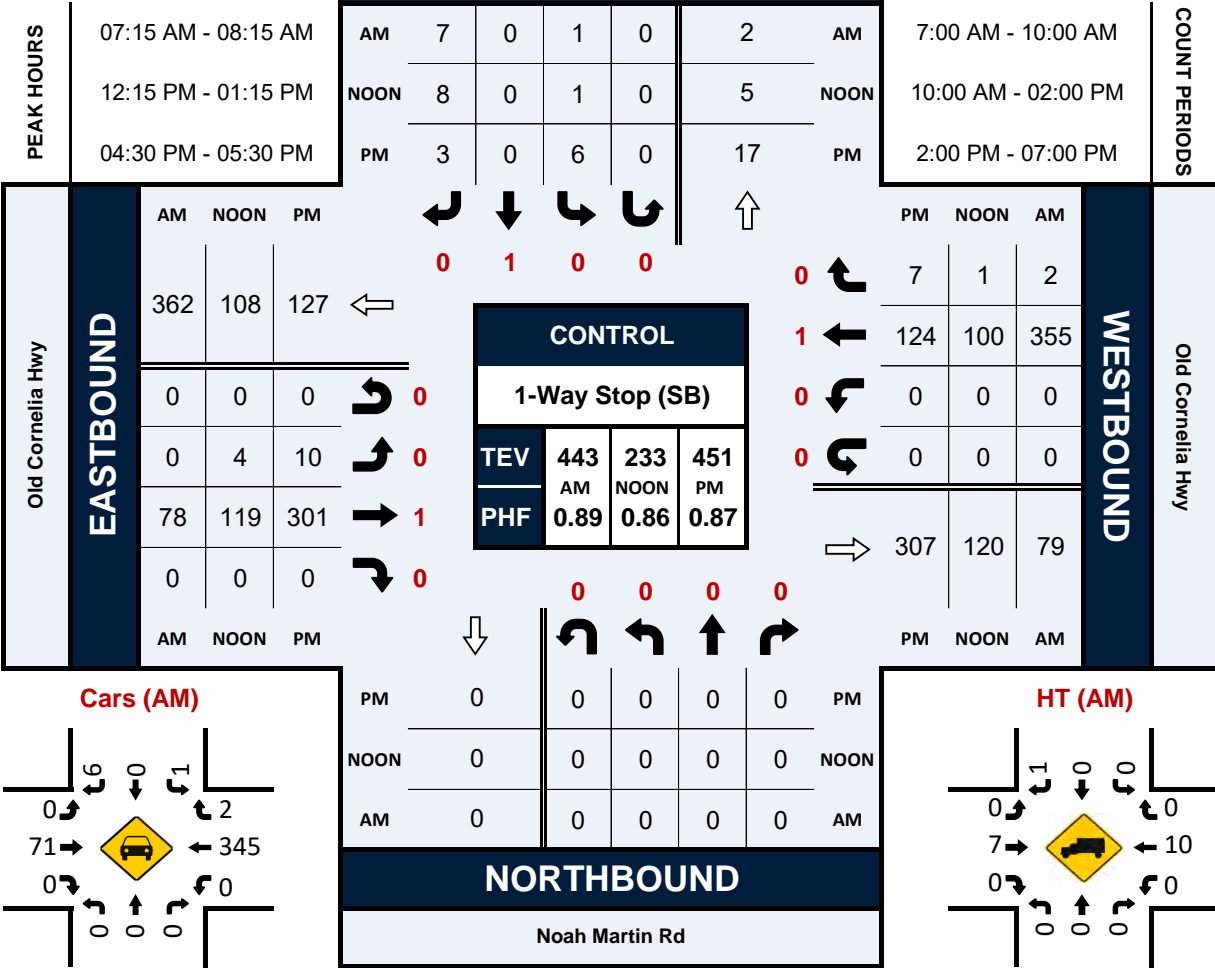

Project ID: 22-180056-005

Location: Noah Martin Rd & Old Cornelia Hwy

City: Lula

Day: Wednesday

Date: 3/30/2022

Groups Printed - Cars, PU, Vans - Heavy Trucks

| Start Time | Noah Martin Rd Northbound | | | | | | Noah Martin Rd Southbound | | | | | | Old Cornelia Hwy Eastbound | | | | | | Old Cornelia Hwy Westbound | | | | | | Int. Total | |
|----------------|---------------------------|------|-----|------|------|------------|---------------------------|------|------|------|------|------------|----------------------------|------|-----|------|------|------------|----------------------------|------|-----|------|------|------------|------------|------|
| | Left | Thru | Rgt | Utum | Peds | App. Total | Left | Thru | Rgt | Utum | Peds | App. Total | Left | Thru | Rgt | Utum | Peds | App. Total | Left | Thru | Rgt | Utum | Peds | App. Total | | |
| 7:00 AM | 0 | 0 | 0 | 0 | 0 | 0 | 0 | 0 | 2 | 0 | 0 | 2 | 0 | 10 | 0 | 0 | 0 | 10 | 0 | 58 | 0 | 0 | 0 | 58 | 0 | 70 |
| 7:15 AM | 0 | 0 | 0 | 0 | 0 | 0 | 0 | 0 | 0 | 0 | 0 | 0 | 0 | 12 | 0 | 0 | 0 | 12 | 0 | 71 | 1 | 0 | 0 | 72 | 0 | 84 |
| 7:30 AM | 0 | 0 | 0 | 0 | 0 | 0 | 0 | 0 | 4 | 0 | 0 | 4 | 0 | 19 | 0 | 0 | 0 | 19 | 0 | 101 | 0 | 0 | 0 | 101 | 0 | 124 |
| 7:45 AM | 0 | 0 | 0 | 0 | 0 | 0 | 1 | 0 | 2 | 0 | 0 | 3 | 0 | 15 | 0 | 0 | 0 | 15 | 0 | 93 | 1 | 0 | 0 | 94 | 0 | 112 |
| Total | 0 | 0 | 0 | 0 | 0 | 0 | 1 | 0 | 8 | 0 | 0 | 9 | 0 | 56 | 0 | 0 | 0 | 56 | 0 | 323 | 2 | 0 | 0 | 325 | 0 | 390 |
| 8:00 AM | 0 | 0 | 0 | 0 | 0 | 0 | 0 | 0 | 1 | 0 | 0 | 1 | 0 | 32 | 0 | 0 | 0 | 32 | 0 | 90 | 0 | 0 | 0 | 90 | 0 | 123 |
| 8:15 AM | 0 | 0 | 0 | 0 | 0 | 0 | 1 | 0 | 2 | 0 | 0 | 3 | 0 | 34 | 0 | 0 | 0 | 34 | 0 | 45 | 1 | 0 | 0 | 46 | 0 | 83 |
| 8:30 AM | 0 | 0 | 0 | 0 | 0 | 0 | 0 | 0 | 0 | 0 | 0 | 0 | 0 | 11 | 0 | 0 | 0 | 11 | 0 | 38 | 0 | 0 | 0 | 38 | 0 | 49 |
| 8:45 AM | 0 | 0 | 0 | 0 | 0 | 0 | 0 | 0 | 1 | 0 | 0 | 1 | 0 | 11 | 0 | 0 | 0 | 11 | 0 | 32 | 1 | 0 | 0 | 33 | 0 | 45 |
| Total | 0 | 0 | 0 | 0 | 0 | 0 | 1 | 0 | 4 | 0 | 0 | 5 | 0 | 88 | 0 | 0 | 0 | 88 | 0 | 205 | 2 | 0 | 0 | 207 | 0 | 300 |
| 9:00 AM | 0 | 0 | 0 | 0 | 0 | 0 | 0 | 0 | 0 | 0 | 0 | 0 | 0 | 15 | 0 | 0 | 0 | 15 | 0 | 28 | 0 | 0 | 0 | 28 | 0 | 43 |
| 9:15 AM | 0 | 0 | 0 | 0 | 0 | 0 | 0 | 0 | 1 | 0 | 0 | 1 | 1 | 16 | 0 | 0 | 0 | 17 | 0 | 32 | 0 | 0 | 0 | 32 | 0 | 50 |
| 9:30 AM | 0 | 0 | 0 | 0 | 0 | 0 | 1 | 0 | 1 | 0 | 0 | 2 | 0 | 16 | 0 | 0 | 0 | 16 | 0 | 26 | 1 | 0 | 0 | 27 | 0 | 45 |
| 9:45 AM | 0 | 0 | 0 | 0 | 0 | 0 | 0 | 0 | 1 | 0 | 0 | 1 | 0 | 13 | 0 | 0 | 0 | 13 | 0 | 38 | 0 | 0 | 0 | 38 | 0 | 52 |
| Total | 0 | 0 | 0 | 0 | 0 | 0 | 1 | 0 | 3 | 0 | 0 | 4 | 1 | 60 | 0 | 0 | 0 | 61 | 0 | 124 | 1 | 0 | 0 | 125 | 0 | 190 |
| ***BREAK*** | | | | | | | | | | | | | | | | | | | | | | | | | | |
| 10:00 AM | 0 | 0 | 0 | 0 | 0 | 0 | 0 | 0 | 1 | 0 | 0 | 1 | 0 | 12 | 0 | 0 | 0 | 12 | 0 | 24 | 0 | 0 | 0 | 24 | 0 | 37 |
| 10:15 AM | 0 | 0 | 0 | 0 | 0 | 0 | 0 | 0 | 1 | 0 | 0 | 1 | 0 | 20 | 0 | 0 | 0 | 20 | 0 | 21 | 1 | 0 | 0 | 22 | 0 | 43 |
| 10:30 AM | 0 | 0 | 0 | 0 | 0 | 0 | 1 | 0 | 2 | 0 | 0 | 3 | 0 | 22 | 0 | 0 | 0 | 22 | 0 | 20 | 0 | 0 | 0 | 20 | 0 | 45 |
| 10:45 AM | 0 | 0 | 0 | 0 | 0 | 0 | 1 | 0 | 2 | 0 | 0 | 3 | 1 | 17 | 0 | 0 | 0 | 18 | 0 | 25 | 2 | 0 | 0 | 27 | 0 | 48 |
| Total | 0 | 0 | 0 | 0 | 0 | 0 | 2 | 0 | 6 | 0 | 0 | 8 | 1 | 71 | 0 | 0 | 0 | 72 | 0 | 90 | 3 | 0 | 0 | 93 | 0 | 173 |
| 11:00 AM | 0 | 0 | 0 | 0 | 0 | 0 | 1 | 0 | 1 | 0 | 0 | 2 | 0 | 19 | 0 | 0 | 0 | 19 | 0 | 16 | 0 | 0 | 0 | 16 | 0 | 37 |
| 11:15 AM | 0 | 0 | 0 | 0 | 0 | 0 | 0 | 0 | 0 | 0 | 0 | 0 | 0 | 28 | 0 | 0 | 0 | 28 | 0 | 23 | 1 | 0 | 0 | 24 | 0 | 52 |
| 11:30 AM | 0 | 0 | 0 | 0 | 0 | 0 | 1 | 0 | 0 | 0 | 0 | 1 | 1 | 29 | 0 | 0 | 0 | 30 | 0 | 23 | 0 | 0 | 0 | 23 | 0 | 54 |
| 11:45 AM | 0 | 0 | 0 | 0 | 0 | 0 | 1 | 0 | 2 | 0 | 0 | 3 | 0 | 17 | 0 | 0 | 0 | 17 | 0 | 24 | 1 | 0 | 0 | 25 | 0 | 45 |
| Total | 0 | 0 | 0 | 0 | 0 | 0 | 3 | 0 | 3 | 0 | 0 | 6 | 1 | 93 | 0 | 0 | 0 | 94 | 0 | 86 | 2 | 0 | 0 | 88 | 0 | 188 |
| 12:00 PM | 0 | 0 | 0 | 0 | 0 | 0 | 1 | 0 | 1 | 0 | 0 | 2 | 2 | 29 | 0 | 0 | 0 | 31 | 0 | 20 | 0 | 0 | 0 | 20 | 0 | 53 |
| 12:15 PM | 0 | 0 | 0 | 0 | 0 | 0 | 0 | 0 | 2 | 0 | 0 | 2 | 2 | 24 | 0 | 0 | 0 | 26 | 0 | 26 | 0 | 0 | 0 | 26 | 0 | 54 |
| 12:30 PM | 0 | 0 | 0 | 0 | 0 | 0 | 0 | 0 | 1 | 0 | 0 | 1 | 0 | 28 | 0 | 0 | 0 | 28 | 0 | 26 | 0 | 0 | 0 | 26 | 0 | 55 |
| 12:45 PM | 0 | 0 | 0 | 0 | 0 | 0 | 0 | 0 | 4 | 0 | 0 | 4 | 1 | 38 | 0 | 0 | 0 | 39 | 0 | 25 | 0 | 0 | 0 | 25 | 0 | 68 |
| Total | 0 | 0 | 0 | 0 | 0 | 0 | 1 | 0 | 8 | 0 | 0 | 9 | 5 | 119 | 0 | 0 | 0 | 124 | 0 | 97 | 0 | 0 | 0 | 97 | 0 | 230 |
| 1:00 PM | 0 | 0 | 0 | 0 | 0 | 0 | 1 | 0 | 1 | 0 | 0 | 2 | 1 | 29 | 0 | 0 | 0 | 30 | 0 | 23 | 1 | 0 | 0 | 24 | 0 | 56 |
| 1:15 PM | 0 | 0 | 0 | 0 | 0 | 0 | 1 | 0 | 0 | 0 | 0 | 1 | 0 | 22 | 0 | 0 | 0 | 22 | 0 | 26 | 0 | 0 | 0 | 26 | 0 | 49 |
| 1:30 PM | 0 | 0 | 0 | 0 | 0 | 0 | 1 | 0 | 1 | 0 | 0 | 2 | 2 | 25 | 0 | 0 | 0 | 27 | 0 | 22 | 1 | 0 | 0 | 23 | 0 | 52 |
| 1:45 PM | 0 | 0 | 0 | 0 | 0 | 0 | 1 | 0 | 2 | 0 | 0 | 3 | 1 | 47 | 0 | 0 | 0 | 48 | 0 | 18 | 1 | 0 | 0 | 19 | 0 | 70 |
| Total | 0 | 0 | 0 | 0 | 0 | 0 | 4 | 0 | 4 | 0 | 0 | 8 | 4 | 123 | 0 | 0 | 0 | 127 | 0 | 89 | 3 | 0 | 0 | 92 | 0 | 227 |
| ***BREAK*** | | | | | | | | | | | | | | | | | | | | | | | | | | |
| 2:00 PM | 0 | 0 | 0 | 0 | 0 | 0 | 0 | 0 | 0 | 0 | 0 | 0 | 0 | 23 | 0 | 0 | 0 | 23 | 0 | 27 | 0 | 0 | 0 | 27 | 0 | 50 |
| 2:15 PM | 0 | 0 | 0 | 0 | 0 | 0 | 1 | 0 | 0 | 0 | 0 | 1 | 2 | 38 | 0 | 0 | 0 | 40 | 0 | 25 | 0 | 0 | 0 | 25 | 0 | 66 |
| 2:30 PM | 0 | 0 | 0 | 0 | 0 | 0 | 1 | 0 | 1 | 0 | 0 | 2 | 3 | 29 | 0 | 0 | 0 | 32 | 0 | 39 | 0 | 0 | 0 | 39 | 0 | 73 |
| 2:45 PM | 0 | 0 | 0 | 0 | 0 | 0 | 2 | 0 | 0 | 0 | 0 | 2 | 0 | 32 | 0 | 0 | 0 | 32 | 0 | 40 | 0 | 0 | 0 | 40 | 0 | 74 |
| Total | 0 | 0 | 0 | 0 | 0 | 0 | 4 | 0 | 1 | 0 | 0 | 5 | 5 | 122 | 0 | 0 | 0 | 127 | 0 | 131 | 0 | 0 | 0 | 131 | 0 | 263 |
| 3:00 PM | 0 | 0 | 0 | 0 | 0 | 0 | 4 | 0 | 1 | 0 | 0 | 5 | 1 | 37 | 0 | 0 | 0 | 38 | 0 | 34 | 1 | 0 | 0 | 35 | 0 | 74 |
| 3:15 PM | 0 | 0 | 0 | 0 | 0 | 0 | 0 | 0 | 1 | 0 | 0 | 1 | 3 | 54 | 0 | 0 | 0 | 57 | 0 | 26 | 1 | 0 | 0 | 27 | 0 | 85 |
| 3:30 PM | 0 | 0 | 0 | 0 | 0 | 0 | 0 | 0 | 0 | 0 | 0 | 0 | 1 | 60 | 0 | 0 | 0 | 61 | 0 | 25 | 0 | 0 | 0 | 25 | 0 | 86 |
| 3:45 PM | 0 | 0 | 0 | 0 | 0 | 0 | 1 | 0 | 1 | 0 | 0 | 2 | 4 | 76 | 0 | 0 | 0 | 80 | 0 | 23 | 0 | 1 | 0 | 24 | 0 | 106 |
| Total | 0 | 0 | 0 | 0 | 0 | 0 | 1 | 0 | 3 | 0 | 0 | 4 | 9 | 227 | 0 | 0 | 0 | 236 | 0 | 108 | 2 | 1 | 0 | 111 | 0 | 351 |
| 4:00 PM | 0 | 0 | 0 | 0 | 0 | 0 | 1 | 0 | 1 | 0 | 0 | 2 | 3 | 61 | 0 | 0 | 0 | 64 | 0 | 22 | 0 | 0 | 0 | 22 | 0 | 88 |
| 4:15 PM | 0 | 0 | 0 | 0 | 0 | 0 | 0 | 0 | 2 | 0 | 0 | 2 | 1 | 54 | 0 | 0 | 0 | 55 | 0 | 35 | 1 | 0 | 0 | 36 | 0 | 93 |
| 4:30 PM | 0 | 0 | 0 | 0 | 0 | 0 | 1 | 0 | 1 | 0 | 0 | 2 | 2 | 62 | 0 | 0 | 0 | 64 | 0 | 30 | 1 | 0 | 0 | 31 | 0 | 97 |
| 4:45 PM | 0 | 0 | 0 | 0 | 0 | 0 | 1 | 0 | 0 | 0 | 0 | 1 | 1 | 79 | 0 | 0 | 0 | 80 | 0 | 27 | 1 | 0 | 0 | 28 | 0 | 109 |
| Total | 0 | 0 | 0 | 0 | 0 | 0 | 3 | 0 | 4 | 0 | 0 | 7 | 7 | 256 | 0 | 0 | 0 | 263 | 0 | 114 | 3 | 0 | 0 | 117 | 0 | 387 |
| 5:00 PM | 0 | 0 | 0 | 0 | 0 | 0 | 1 | 0 | 2 | 0 | 0 | 3 | 3 | 74 | 0 | 0 | 0 | 77 | 0 | 33 | 2 | 0 | 0 | 35 | 0 | 115 |
| 5:15 PM | 0 | 0 | 0 | 0 | 0 | 0 | 3 | 0 | 0 | 0 | 0 | 3 | 4 | 86 | 0 | 0 | 0 | 90 | 0 | 34 | 3 | 0 | 0 | 37 | 0 | 130 |
| 5:30 PM | 0 | 0 | 0 | 0 | 0 | 0 | 1 | 0 | 0 | 0 | 0 | 1 | 2 | 67 | 0 | 0 | 0 | 69 | 0 | 22 | 0 | 0 | 0 | 22 | 0 | 92 |
| 5:45 PM | 0 | 0 | 0 | 0 | 0 | 0 | 0 | 0 | 3 | 0 | 0 | 3 | 1 | 58 | 0 | 0 | 0 | 59 | 0 | 16 | 1 | 0 | 0 | 17 | 0 | 79 |
| Total | 0 | 0 | 0 | 0 | 0 | 0 | 5 | 0 | 5 | 0 | 0 | 10 | 10 | 285 | 0 | 0 | 0 | 295 | 0 | 105 | 6 | 0 | 0 | 111 | 0 | 416 |
| 6:00 PM | 0 | 0 | 0 | 0 | 0 | 0 | 2 | 0 | 1 | 0 | 0 | 3 | 4 | 61 | 0 | 0 | 0 | 65 | 0 | 32 | 1 | 0 | 0 | 33 | 0 | 101 |
| 6:15 PM | 0 | 0 | 0 | 0 | 0 | 0 | 0 | 0 | 0 | 0 | 0 | 0 | 4 | 58 | 0 | 0 | 0 | 62 | 0 | 18 | 1 | 0 | 0 | 19 | 0 | 81 |
| 6:30 PM | 0 | 0 | 0 | 0 | 0 | 0 | 1 | 0 | 4 | 0 | 0 | 5 | 2 | 43 | 0 | 0 | 0 | 45 | 0 | 29 | 0 | 0 | 0 | 29 | 0 | 79 |
| 6:45 PM | 0 | 0 | 0 | 0 | 0 | 0 | 1 | 0 | 2 | 0 | 0 | 3 | 1 | 30 | 0 | 0 | 0 | 31 | 0 | 25 | 0 | 0 | 0 | 25 | 0 | 59 |
| Total | 0 | 0 | 0 | 0 | 0 | 0 | 4 | 0 | 7 | 0 | 0 | 11 | 11 | 192 | 0 | 0 | 0 | 203 | 0 | 104 | 2 | 0 | 0 | 106 | 0 | 320 |
| Grand Total | 0 | 0 | 0 | 0 | 0 | 0 | 30 | 0 | 56 | 0 | 0 | 86 | 54 | 1692 | 0 | 0 | 0 | 1746 | 0 | 1576 | 26 | 1 | 0 | 1603 | 0 | 3435 |
| Apprch % | 0.0 | 0.0 | 0.0 | 0.0 | 0.0 | 0.0 | 34.9 | 0.0 | 65.1 | 0.0 | 0.0 | 0.0 | 3.1 | 96.9 | 0.0 | 0.0 | 0.0 | 0.0 | 98.3 | 1.6 | 0.1 | 0.0 | 0.0 | 0.0 | 0.0 | |
| Total % | 0.0 | 0.0 | 0.0 | 0.0 | 0.0 | 0.0 | 0.9 | 0.0 | 1.6 | 0.0 | 0.0 | 2.5 | 1.6 | 49.3 | 0.0 | 0.0 | 0.0 | 50.8 | 45.9 | 0.8 | 0.0 | 0.0 | 46.7 | 0.0 | 0.0 | |
| Cars, PU, Vans | 0 | 0 | 0 | | | | | | | | | | | | | | | | | | | | | | | |

%Heavy trucks | 0.0 0.0 0.0 0.0 0.0 | 6.7 0.0 10.7 0.0 9.3 | 9.3 4.6 0.0 0.0 4.8 | 0.0 5.1 0.0 0.0 5.0 | 5.0

Project ID: 22-180056-005

Location: Noah Martin Rd & Old Cornelia Hwy

City: Lula

PEAK HOURS

Day: Wednesday

Date: 3/30/2022

AM

| Start Time | Noah Martin Rd Northbound | | | | | Noah Martin Rd Southbound | | | | | Old Cornelia Hwy Eastbound | | | | | Old Cornelia Hwy Westbound | | | | | Int. Total |
|--|---------------------------|------|-----|------|------------|---------------------------|------|------|------|------------|----------------------------|-------|-----|------|------------|----------------------------|------|-------|------|------------|------------|
| | Left | Thru | Rgt | Utum | App. Total | Left | Thru | Rgt | Utum | App. Total | Left | Thru | Rgt | Utum | App. Total | Left | Thru | Rgt | Utum | App. Total | |
| Peak Hour Analysis from 07:00 AM - 10:00 AM | | | | | | | | | | | | | | | | | | | | | |
| Peak Hour for Entire Intersection Begins at 07:15 AM | | | | | | | | | | | | | | | | | | | | | |
| 7:15 AM | 0 | 0 | 0 | 0 | 0 | 0 | 0 | 0 | 0 | 0 | 0 | 12 | 0 | 0 | 12 | 0 | 71 | 1 | 0 | 72 | 84 |
| 7:30 AM | 0 | 0 | 0 | 0 | 0 | 0 | 0 | 4 | 0 | 4 | 0 | 19 | 0 | 0 | 19 | 0 | 101 | 0 | 0 | 101 | 124 |
| 7:45 AM | 0 | 0 | 0 | 0 | 0 | 1 | 0 | 2 | 0 | 3 | 0 | 15 | 0 | 0 | 15 | 0 | 93 | 1 | 0 | 94 | 112 |
| 8:00 AM | 0 | 0 | 0 | 0 | 0 | 0 | 0 | 1 | 0 | 1 | 0 | 32 | 0 | 0 | 32 | 0 | 90 | 0 | 0 | 90 | 123 |
| Total Volume | 0 | 0 | 0 | 0 | 0 | 1 | 0 | 7 | 0 | 8 | 0 | 78 | 0 | 0 | 78 | 0 | 355 | 2 | 0 | 357 | 443 |
| % App. Total | 0.0 | 0.0 | 0.0 | 0.0 | 0.0 | 12.5 | 0.0 | 87.5 | 0.0 | 100 | 0.0 | 100.0 | 0.0 | 0.0 | 100 | 0.0 | 99.4 | 0.6 | 0.0 | 100 | |
| PHF | 0.500 | | | | | | | | | | 0.609 | | | | | 0.884 | | | | | 0.893 |
| Cars, PU, Vans | 0 | 0 | 0 | 0 | 0 | 1 | 0 | 6 | 0 | 7 | 0 | 71 | 0 | 0 | 71 | 0 | 345 | 2 | 0 | 347 | 425 |
| % Cars, PU, Vans | 0.0 | 0.0 | 0.0 | 0.0 | 0.0 | 100.0 | 0.0 | 85.7 | 0.0 | 87.5 | 0.0 | 91.0 | 0.0 | 0.0 | 91.0 | 0.0 | 97.2 | 100.0 | 0.0 | 97.2 | 95.9 |
| Heavy trucks | 0 | 0 | 0 | 0 | 0 | 0 | 0 | 1 | 0 | 1 | 0 | 7 | 0 | 0 | 7 | 0 | 10 | 0 | 0 | 10 | 18 |
| % Heavy trucks | 0.0 | 0.0 | 0.0 | 0.0 | 0.0 | 0.0 | 0.0 | 14.3 | 0.0 | 12.5 | 0.0 | 9.0 | 0.0 | 0.0 | 9.0 | 0.0 | 2.8 | 0.0 | 0.0 | 2.8 | 4.1 |

NOON

| Start Time | Noah Martin Rd Northbound | | | | | Noah Martin Rd Southbound | | | | | Old Cornelia Hwy Eastbound | | | | | Old Cornelia Hwy Westbound | | | | | Int. Total |
|--|---------------------------|------|-----|------|------------|---------------------------|------|-------|------|------------|----------------------------|------|-----|------|------------|----------------------------|------|-------|------|------------|------------|
| | Left | Thru | Rgt | Utum | App. Total | Left | Thru | Rgt | Utum | App. Total | Left | Thru | Rgt | Utum | App. Total | Left | Thru | Rgt | Utum | App. Total | |
| Peak Hour Analysis from 10:00 AM - 02:00 PM | | | | | | | | | | | | | | | | | | | | | |
| Peak Hour for Entire Intersection Begins at 12:15 PM | | | | | | | | | | | | | | | | | | | | | |
| 12:15 PM | 0 | 0 | 0 | 0 | 0 | 0 | 0 | 2 | 0 | 2 | 2 | 24 | 0 | 0 | 26 | 0 | 26 | 0 | 0 | 26 | 54 |
| 12:30 PM | 0 | 0 | 0 | 0 | 0 | 0 | 0 | 1 | 0 | 1 | 0 | 28 | 0 | 0 | 28 | 0 | 26 | 0 | 0 | 26 | 55 |
| 12:45 PM | 0 | 0 | 0 | 0 | 0 | 0 | 0 | 4 | 0 | 4 | 1 | 38 | 0 | 0 | 39 | 0 | 25 | 0 | 0 | 25 | 68 |
| 1:00 PM | 0 | 0 | 0 | 0 | 0 | 1 | 0 | 1 | 0 | 2 | 1 | 29 | 0 | 0 | 30 | 0 | 23 | 1 | 0 | 24 | 56 |
| Total Volume | 0 | 0 | 0 | 0 | 0 | 1 | 0 | 8 | 0 | 9 | 4 | 119 | 0 | 0 | 123 | 0 | 100 | 1 | 0 | 101 | 233 |
| % App. Total | 0.0 | 0.0 | 0.0 | 0.0 | 0.0 | 11.1 | 0.0 | 88.9 | 0.0 | 100 | 3.3 | 96.7 | 0.0 | 0.0 | 100 | 0.0 | 99.0 | 1.0 | 0.0 | 100 | |
| PHF | 0.563 | | | | | | | | | | 0.788 | | | | | 0.971 | | | | | 0.857 |
| Cars, PU, Vans | 0 | 0 | 0 | 0 | 0 | 1 | 0 | 8 | 0 | 9 | 3 | 114 | 0 | 0 | 117 | 0 | 93 | 1 | 0 | 94 | 220 |
| % Cars, PU, Vans | 0.0 | 0.0 | 0.0 | 0.0 | 0.0 | 100.0 | 0.0 | 100.0 | 0.0 | 100.0 | 75.0 | 95.8 | 0.0 | 0.0 | 95.1 | 0.0 | 93.0 | 100.0 | 0.0 | 93.1 | 94.4 |
| Heavy trucks | 0 | 0 | 0 | 0 | 0 | 0 | 0 | 0 | 0 | 0 | 1 | 5 | 0 | 0 | 6 | 0 | 7 | 0 | 0 | 7 | 13 |
| % Heavy trucks | 0.0 | 0.0 | 0.0 | 0.0 | 0.0 | 0.0 | 0.0 | 0.0 | 0.0 | 0.0 | 25.0 | 4.2 | 0.0 | 0.0 | 4.9 | 0.0 | 7.0 | 0.0 | 0.0 | 6.9 | 5.6 |

PM

| Start Time | Noah Martin Rd Northbound | | | | | Noah Martin Rd Southbound | | | | | Old Cornelia Hwy Eastbound | | | | | Old Cornelia Hwy Westbound | | | | | Int. Total |
|--|---------------------------|------|-----|------|------------|---------------------------|------|-------|------|------------|----------------------------|------|-----|------|------------|----------------------------|------|-------|------|------------|------------|
| | Left | Thru | Rgt | Utum | App. Total | Left | Thru | Rgt | Utum | App. Total | Left | Thru | Rgt | Utum | App. Total | Left | Thru | Rgt | Utum | App. Total | |
| Peak Hour Analysis from 02:00 PM - 07:00 PM | | | | | | | | | | | | | | | | | | | | | |
| Peak Hour for Entire Intersection Begins at 04:30 PM | | | | | | | | | | | | | | | | | | | | | |
| 4:30 PM | 0 | 0 | 0 | 0 | 0 | 1 | 0 | 1 | 0 | 2 | 2 | 62 | 0 | 0 | 64 | 0 | 30 | 1 | 0 | 31 | 97 |
| 4:45 PM | 0 | 0 | 0 | 0 | 0 | 1 | 0 | 0 | 0 | 1 | 1 | 79 | 0 | 0 | 80 | 0 | 27 | 1 | 0 | 28 | 109 |
| 5:00 PM | 0 | 0 | 0 | 0 | 0 | 1 | 0 | 2 | 0 | 3 | 3 | 74 | 0 | 0 | 77 | 0 | 33 | 2 | 0 | 35 | 115 |
| 5:15 PM | 0 | 0 | 0 | 0 | 0 | 3 | 0 | 0 | 0 | 3 | 4 | 86 | 0 | 0 | 90 | 0 | 34 | 3 | 0 | 37 | 130 |
| Total Volume | 0 | 0 | 0 | 0 | 0 | 6 | 0 | 3 | 0 | 9 | 10 | 301 | 0 | 0 | 311 | 0 | 124 | 7 | 0 | 131 | 451 |
| % App. Total | 0.0 | 0.0 | 0.0 | 0.0 | 0.0 | 66.7 | 0.0 | 33.3 | 0.0 | 100 | 3.2 | 96.8 | 0.0 | 0.0 | 100 | 0.0 | 94.7 | 5.3 | 0.0 | 100 | |
| PHF | 0.750 | | | | | | | | | | 0.864 | | | | | 0.885 | | | | | 0.867 |
| Cars, PU, Vans | 0 | 0 | 0 | 0 | 0 | 6 | 0 | 3 | 0 | 9 | 10 | 294 | 0 | 0 | 304 | 0 | 118 | 7 | 0 | 125 | 438 |
| % Cars, PU, Vans | 0.0 | 0.0 | 0.0 | 0.0 | 0.0 | 100.0 | 0.0 | 100.0 | 0.0 | 100.0 | 100.0 | 97.7 | 0.0 | 0.0 | 97.7 | 0.0 | 95.2 | 100.0 | 0.0 | 95.4 | 97.1 |
| Heavy trucks | 0 | 0 | 0 | 0 | 0 | 0 | 0 | 0 | 0 | 0 | 0 | 7 | 0 | 0 | 7 | 0 | 6 | 0 | 0 | 6 | 13 |
| % Heavy trucks | 0.0 | 0.0 | 0.0 | 0.0 | 0.0 | 0.0 | 0.0 | 0.0 | 0.0 | 0.0 | 0.0 | 2.3 | 0.0 | 0.0 | 2.3 | 0.0 | 4.8 | 0.0 | 0.0 | 4.6 | 2.9 |

National Data & Surveying Services Intersection Turning Movement Count

Location: US 23/SR 365/Cornelia Hwy & Cagle Rd
 City: Lula
 Control: 2-Way Stop (EB/WB)

Project ID: 22-180056-006
 Date: 3/30/2022

Data - Total

| NS/EW Streets: | US 23/SR 365/Cornelia Hwy | | | | US 23/SR 365/Cornelia Hwy | | | | Cagle Rd | | | | Cagle Rd | | | | TOTAL |
|------------------|---------------------------|---------|---------|---------|---------------------------|---------|---------|---------|-----------|---------|---------|---------|-----------|---------|---------|---------|-------|
| AM | NORTHBOUND | | | | SOUTHBOUND | | | | EASTBOUND | | | | WESTBOUND | | | | |
| | 1 NL | 2 NT | 1 NR | 0 NU | 1 SL | 2 ST | 1 SR | 0 SU | 0 EL | 1 ET | 1 ER | 0 EU | 0 WL | 1 WT | 1 WR | 0 WU | |
| 7:00 AM | 1 | 149 | 0 | 1 | 0 | 418 | 2 | 0 | 1 | 0 | 0 | 0 | 0 | 0 | 1 | 0 | |
| 7:15 AM | 0 | 191 | 0 | 0 | 0 | 564 | 0 | 0 | 1 | 0 | 1 | 0 | 2 | 0 | 0 | 0 | |
| 7:30 AM | 0 | 246 | 0 | 0 | 0 | 605 | 1 | 0 | 1 | 2 | 0 | 0 | 8 | 0 | 0 | 0 | |
| 7:45 AM | 0 | 170 | 0 | 0 | 0 | 476 | 0 | 0 | 0 | 0 | 0 | 0 | 8 | 0 | 0 | 0 | |
| 8:00 AM | 0 | 221 | 0 | 0 | 0 | 429 | 1 | 0 | 1 | 0 | 0 | 0 | 3 | 2 | 1 | 0 | |
| 8:15 AM | 3 | 211 | 6 | 0 | 0 | 378 | 2 | 0 | 0 | 1 | 1 | 0 | 1 | 1 | 0 | 0 | |
| 8:30 AM | 0 | 182 | 2 | 0 | 0 | 336 | 0 | 0 | 2 | 0 | 0 | 0 | 5 | 0 | 0 | 0 | |
| 8:45 AM | 0 | 221 | 0 | 0 | 1 | 303 | 1 | 0 | 0 | 0 | 0 | 0 | 4 | 0 | 0 | 0 | |
| 9:00 AM | 1 | 187 | 1 | 0 | 1 | 296 | 1 | 0 | 0 | 0 | 0 | 0 | 2 | 0 | 0 | 0 | |
| 9:15 AM | 2 | 193 | 2 | 0 | 1 | 264 | 1 | 0 | 1 | 1 | 3 | 0 | 2 | 1 | 1 | 0 | |
| 9:30 AM | 0 | 207 | 1 | 0 | 1 | 248 | 0 | 0 | 1 | 0 | 1 | 0 | 1 | 1 | 0 | 0 | |
| 9:45 AM | 1 | 168 | 0 | 0 | 0 | 282 | 0 | 0 | 0 | 0 | 0 | 0 | 3 | 0 | 0 | 0 | |
| TOTAL VOLUMES : | NL | NT | NR | NU | SL | ST | SR | SU | EL | ET | ER | EU | WL | WT | WR | WU | |
| APPROACH %'s : | 0.34% | 99.11% | 0.51% | 0.04% | 0.09% | 99.72% | 0.20% | 0.00% | 44.44% | 22.22% | 33.33% | 0.00% | 82.98% | 10.64% | 6.38% | 0.00% | |
| PEAK HR : | 07:15 AM - 08:15 AM | | | | | | | | | | | | | | | | |
| PEAK HR VOL : | 0 | 828 | 0 | 0 | 0 | 2074 | 2 | 0 | 3 | 2 | 1 | 0 | 21 | 2 | 1 | 0 | |
| PEAK HR FACTOR : | 0.000 | 0.841 | 0.000 | 0.000 | 0.000 | 0.857 | 0.500 | 0.000 | 0.750 | 0.250 | 0.250 | 0.000 | 0.656 | 0.250 | 0.250 | 0.000 | |
| | 0.841 | | | | 0.856 | | | | 0.500 | | | | 0.750 | | | | 0.850 |
| PM | NORTHBOUND | | | | SOUTHBOUND | | | | EASTBOUND | | | | WESTBOUND | | | | TOTAL |
| | 1 NL | 2 NT | 1 NR | 0 NU | 1 SL | 2 ST | 1 SR | 0 SU | 0 EL | 1 ET | 1 ER | 0 EU | 0 WL | 1 WT | 1 WR | 0 WU | |
| 4:00 PM | 0 | 456 | 4 | 0 | 0 | 235 | 2 | 0 | 0 | 0 | 0 | 0 | 4 | 0 | 0 | 0 | |
| 4:15 PM | 0 | 556 | 5 | 0 | 0 | 264 | 1 | 0 | 1 | 0 | 0 | 0 | 3 | 2 | 0 | 0 | |
| 4:30 PM | 0 | 487 | 10 | 0 | 2 | 239 | 0 | 0 | 2 | 0 | 1 | 0 | 4 | 0 | 1 | 0 | |
| 4:45 PM | 0 | 560 | 7 | 0 | 0 | 250 | 3 | 0 | 2 | 0 | 0 | 0 | 3 | 0 | 0 | 0 | |
| 5:00 PM | 1 | 567 | 1 | 0 | 1 | 228 | 1 | 0 | 1 | 1 | 0 | 1 | 3 | 0 | 3 | 0 | |
| 5:15 PM | 1 | 596 | 8 | 0 | 0 | 267 | 0 | 0 | 0 | 0 | 2 | 0 | 4 | 0 | 0 | 0 | |
| 5:30 PM | 0 | 623 | 8 | 0 | 0 | 242 | 0 | 0 | 2 | 0 | 2 | 0 | 2 | 0 | 1 | 0 | |
| 5:45 PM | 1 | 505 | 6 | 0 | 0 | 216 | 1 | 0 | 0 | 0 | 0 | 0 | 3 | 0 | 0 | 0 | |
| 6:00 PM | 0 | 417 | 3 | 0 | 1 | 220 | 3 | 0 | 1 | 0 | 0 | 0 | 2 | 0 | 0 | 0 | |
| 6:15 PM | 0 | 323 | 3 | 0 | 1 | 221 | 1 | 0 | 0 | 1 | 0 | 0 | 2 | 0 | 1 | 0 | |
| 6:30 PM | 0 | 323 | 5 | 1 | 1 | 208 | 1 | 0 | 0 | 0 | 0 | 0 | 1 | 0 | 0 | 0 | |
| 6:45 PM | 0 | 265 | 4 | 0 | 1 | 159 | 0 | 0 | 0 | 0 | 0 | 0 | 0 | 1 | 0 | 0 | |
| TOTAL VOLUMES : | NL | NT | NR | NU | SL | ST | SR | SU | EL | ET | ER | EU | WL | WT | WR | WU | |
| APPROACH %'s : | 0.05% | 98.82% | 1.11% | 0.02% | 0.25% | 99.28% | 0.47% | 0.00% | 52.94% | 11.76% | 29.41% | 5.88% | 77.50% | 7.50% | 15.00% | 0.00% | |
| PEAK HR : | 04:45 PM - 05:45 PM | | | | | | | | | | | | | | | | |
| PEAK HR VOL : | 2 | 2346 | 24 | 0 | 1 | 987 | 4 | 0 | 5 | 1 | 4 | 1 | 12 | 0 | 4 | 0 | |
| PEAK HR FACTOR : | 0.500 | 0.941 | 0.750 | 0.000 | 0.250 | 0.924 | 0.333 | 0.000 | 0.625 | 0.250 | 0.500 | 0.250 | 0.750 | 0.000 | 0.333 | 0.000 | |
| | 0.940 | | | | 0.929 | | | | 0.688 | | | | 0.667 | | | | 0.963 |

National Data & Surveying Services Intersection Turning Movement Count

Location: US 23/SR 365/Cornelia Hwy & Cagle Rd
 City: Lula
 Control: 2-Way Stop (EB/WB)

Project ID: 22-180056-006
 Date: 3/30/2022

Data - Cars

| NS/EW Streets: | US 23/SR 365/Cornelia Hwy | | | | US 23/SR 365/Cornelia Hwy | | | | Cagle Rd | | | | Cagle Rd | | | | |
|------------------|---------------------------|---------|---------|---------|---------------------------|---------|---------|---------|-----------|---------|---------|---------|-----------|---------|---------|---------|-------|
| AM | NORTHBOUND | | | | SOUTHBOUND | | | | EASTBOUND | | | | WESTBOUND | | | | TOTAL |
| | 1 NL | 2 NT | 1 NR | 0 NU | 1 SL | 2 ST | 1 SR | 0 SU | 0 EL | 1 ET | 1 ER | 0 EU | 0 WL | 1 WT | 1 WR | 0 WU | |
| 7:00 AM | 1 | 130 | 0 | 0 | 0 | 401 | 2 | 0 | 1 | 0 | 0 | 0 | 0 | 0 | 0 | 0 | 535 |
| 7:15 AM | 0 | 167 | 0 | 0 | 0 | 545 | 0 | 0 | 0 | 0 | 1 | 0 | 2 | 0 | 0 | 0 | 715 |
| 7:30 AM | 0 | 230 | 0 | 0 | 0 | 581 | 1 | 0 | 1 | 0 | 0 | 0 | 8 | 0 | 0 | 0 | 821 |
| 7:45 AM | 0 | 155 | 0 | 0 | 0 | 450 | 0 | 0 | 0 | 0 | 0 | 0 | 8 | 0 | 0 | 0 | 613 |
| 8:00 AM | 0 | 189 | 0 | 0 | 0 | 406 | 1 | 0 | 1 | 0 | 0 | 0 | 3 | 2 | 1 | 0 | 603 |
| 8:15 AM | 3 | 182 | 6 | 0 | 0 | 347 | 2 | 0 | 0 | 1 | 1 | 0 | 1 | 1 | 0 | 0 | 544 |
| 8:30 AM | 0 | 154 | 2 | 0 | 0 | 314 | 0 | 0 | 2 | 0 | 0 | 0 | 5 | 0 | 0 | 0 | 477 |
| 8:45 AM | 0 | 190 | 0 | 0 | 1 | 273 | 1 | 0 | 0 | 0 | 0 | 0 | 4 | 0 | 0 | 0 | 469 |
| 9:00 AM | 1 | 165 | 1 | 0 | 1 | 273 | 1 | 0 | 0 | 0 | 0 | 0 | 2 | 0 | 0 | 0 | 444 |
| 9:15 AM | 2 | 164 | 2 | 0 | 1 | 246 | 1 | 0 | 1 | 1 | 3 | 0 | 2 | 1 | 1 | 0 | 425 |
| 9:30 AM | 0 | 176 | 1 | 0 | 1 | 230 | 0 | 0 | 1 | 0 | 1 | 0 | 1 | 1 | 0 | 0 | 412 |
| 9:45 AM | 1 | 143 | 0 | 0 | 0 | 247 | 0 | 0 | 0 | 0 | 0 | 0 | 3 | 0 | 0 | 0 | 394 |
| TOTAL VOLUMES : | NL | NT | NR | NU | SL | ST | SR | SU | EL | ET | ER | EU | WL | WT | WR | WU | TOTAL |
| APPROACH %'s : | 8 | 2045 | 12 | 0 | 4 | 4313 | 9 | 0 | 7 | 2 | 6 | 0 | 39 | 5 | 2 | 0 | 6452 |
| | 0.39% | 99.03% | 0.58% | 0.00% | 0.09% | 99.70% | 0.21% | 0.00% | 46.67% | 13.33% | 40.00% | 0.00% | 84.78% | 10.87% | 4.35% | 0.00% | |
| PEAK HR : | 07:15 AM - 08:15 AM | | | | | | | | | | | | | | | | TOTAL |
| PEAK HR VOL : | 0 | 741 | 0 | 0 | 0 | 1982 | 2 | 0 | 2 | 0 | 1 | 0 | 21 | 2 | 1 | 0 | 2752 |
| PEAK HR FACTOR : | 0.000 | 0.805 | 0.000 | 0.000 | 0.000 | 0.853 | 0.500 | 0.000 | 0.500 | 0.000 | 0.250 | 0.000 | 0.656 | 0.250 | 0.250 | 0.000 | 0.838 |
| | 0.805 | | | | 0.852 | | | | 0.750 | | | | 0.750 | | | | |
| PM | NORTHBOUND | | | | SOUTHBOUND | | | | EASTBOUND | | | | WESTBOUND | | | | TOTAL |
| | 1 NL | 2 NT | 1 NR | 0 NU | 1 SL | 2 ST | 1 SR | 0 SU | 0 EL | 1 ET | 1 ER | 0 EU | 0 WL | 1 WT | 1 WR | 0 WU | |
| 4:00 PM | 0 | 430 | 4 | 0 | 0 | 216 | 2 | 0 | 0 | 0 | 0 | 0 | 4 | 0 | 0 | 0 | 656 |
| 4:15 PM | 0 | 534 | 5 | 0 | 0 | 237 | 1 | 0 | 1 | 0 | 0 | 0 | 3 | 1 | 0 | 0 | 782 |
| 4:30 PM | 0 | 473 | 10 | 0 | 2 | 215 | 0 | 0 | 2 | 0 | 1 | 0 | 4 | 0 | 1 | 0 | 708 |
| 4:45 PM | 0 | 529 | 7 | 0 | 0 | 228 | 3 | 0 | 2 | 0 | 0 | 0 | 3 | 0 | 0 | 0 | 772 |
| 5:00 PM | 1 | 541 | 1 | 0 | 1 | 204 | 1 | 0 | 1 | 1 | 0 | 1 | 3 | 0 | 3 | 0 | 758 |
| 5:15 PM | 1 | 573 | 8 | 0 | 0 | 252 | 0 | 0 | 0 | 0 | 2 | 0 | 4 | 0 | 0 | 0 | 840 |
| 5:30 PM | 0 | 603 | 8 | 0 | 0 | 224 | 0 | 0 | 2 | 0 | 2 | 0 | 2 | 0 | 1 | 0 | 842 |
| 5:45 PM | 1 | 494 | 6 | 0 | 0 | 201 | 1 | 0 | 0 | 0 | 0 | 0 | 3 | 0 | 0 | 0 | 706 |
| 6:00 PM | 0 | 403 | 3 | 0 | 1 | 198 | 3 | 0 | 1 | 0 | 0 | 0 | 2 | 0 | 0 | 0 | 611 |
| 6:15 PM | 0 | 317 | 3 | 0 | 1 | 202 | 1 | 0 | 0 | 1 | 0 | 0 | 2 | 0 | 1 | 0 | 528 |
| 6:30 PM | 0 | 315 | 5 | 0 | 0 | 194 | 1 | 0 | 0 | 0 | 0 | 0 | 1 | 0 | 0 | 0 | 516 |
| 6:45 PM | 0 | 256 | 4 | 0 | 1 | 142 | 0 | 0 | 0 | 0 | 0 | 0 | 0 | 1 | 0 | 0 | 404 |
| TOTAL VOLUMES : | NL | NT | NR | NU | SL | ST | SR | SU | EL | ET | ER | EU | WL | WT | WR | WU | TOTAL |
| APPROACH %'s : | 3 | 5468 | 64 | 0 | 6 | 2513 | 13 | 0 | 9 | 2 | 5 | 1 | 31 | 2 | 6 | 0 | 8123 |
| | 0.05% | 98.79% | 1.16% | 0.00% | 0.24% | 99.25% | 0.51% | 0.00% | 52.94% | 11.76% | 29.41% | 5.88% | 79.49% | 5.13% | 15.38% | 0.00% | |
| PEAK HR : | 04:45 PM - 05:45 PM | | | | | | | | | | | | | | | | TOTAL |
| PEAK HR VOL : | 2 | 2246 | 24 | 0 | 1 | 908 | 4 | 0 | 5 | 1 | 4 | 1 | 12 | 0 | 4 | 0 | 3212 |
| PEAK HR FACTOR : | 0.500 | 0.931 | 0.750 | 0.000 | 0.250 | 0.901 | 0.333 | 0.000 | 0.625 | 0.250 | 0.500 | 0.250 | 0.750 | 0.000 | 0.333 | 0.000 | 0.954 |
| | 0.930 | | | | 0.906 | | | | 0.688 | | | | 0.667 | | | | |

National Data & Surveying Services Intersection Turning Movement Count

Location: US 23/SR 365/Cornelia Hwy & Cagle Rd
 City: Lula
 Control: 2-Way Stop (EB/WB)

Project ID: 22-180056-006
 Date: 3/30/2022

Data - HT

| NS/EW Streets: | US 23/SR 365/Cornelia Hwy | | | | US 23/SR 365/Cornelia Hwy | | | | Cagle Rd | | | | Cagle Rd | | | | |
|------------------|---------------------------|---------|---------|---------|---------------------------|---------|---------|---------|-----------|---------|---------|---------|-----------|---------|---------|---------|-------|
| AM | NORTHBOUND | | | | SOUTHBOUND | | | | EASTBOUND | | | | WESTBOUND | | | | TOTAL |
| | 1 NL | 2 NT | 1 NR | 0 NU | 1 SL | 2 ST | 1 SR | 0 SU | 0 EL | 1 ET | 1 ER | 0 EU | 0 WL | 1 WT | 1 WR | 0 WU | |
| 7:00 AM | 0 | 19 | 0 | 1 | 0 | 17 | 0 | 0 | 0 | 0 | 0 | 0 | 0 | 0 | 1 | 0 | 38 |
| 7:15 AM | 0 | 24 | 0 | 0 | 0 | 19 | 0 | 0 | 1 | 0 | 0 | 0 | 0 | 0 | 0 | 0 | 44 |
| 7:30 AM | 0 | 16 | 0 | 0 | 0 | 24 | 0 | 0 | 0 | 2 | 0 | 0 | 0 | 0 | 0 | 0 | 42 |
| 7:45 AM | 0 | 15 | 0 | 0 | 0 | 26 | 0 | 0 | 0 | 0 | 0 | 0 | 0 | 0 | 0 | 0 | 41 |
| 8:00 AM | 0 | 32 | 0 | 0 | 0 | 23 | 0 | 0 | 0 | 0 | 0 | 0 | 0 | 0 | 0 | 0 | 55 |
| 8:15 AM | 0 | 29 | 0 | 0 | 0 | 31 | 0 | 0 | 0 | 0 | 0 | 0 | 0 | 0 | 0 | 0 | 60 |
| 8:30 AM | 0 | 28 | 0 | 0 | 0 | 22 | 0 | 0 | 0 | 0 | 0 | 0 | 0 | 0 | 0 | 0 | 50 |
| 8:45 AM | 0 | 31 | 0 | 0 | 0 | 30 | 0 | 0 | 0 | 0 | 0 | 0 | 0 | 0 | 0 | 0 | 61 |
| 9:00 AM | 0 | 22 | 0 | 0 | 0 | 23 | 0 | 0 | 0 | 0 | 0 | 0 | 0 | 0 | 0 | 0 | 45 |
| 9:15 AM | 0 | 29 | 0 | 0 | 0 | 18 | 0 | 0 | 0 | 0 | 0 | 0 | 0 | 0 | 0 | 0 | 47 |
| 9:30 AM | 0 | 31 | 0 | 0 | 0 | 18 | 0 | 0 | 0 | 0 | 0 | 0 | 0 | 0 | 0 | 0 | 49 |
| 9:45 AM | 0 | 25 | 0 | 0 | 0 | 35 | 0 | 0 | 0 | 0 | 0 | 0 | 0 | 0 | 0 | 0 | 60 |
| TOTAL VOLUMES : | NL | NT | NR | NU | SL | ST | SR | SU | EL | ET | ER | EU | WL | WT | WR | WU | TOTAL |
| APPROACH %'s : | 0.00% | 99.67% | 0.00% | 0.33% | 0.00% | 100.00% | 0.00% | 0.00% | 33.33% | 66.67% | 0.00% | 0.00% | 0.00% | 0.00% | 100.00% | 0.00% | 592 |
| PEAK HR : | 07:15 AM - 08:15 AM | | | | | | | | | | | | | | | | TOTAL |
| PEAK HR VOL : | 0 | 87 | 0 | 0 | 0 | 92 | 0 | 0 | 1 | 2 | 0 | 0 | 0 | 0 | 0 | 0 | 182 |
| PEAK HR FACTOR : | 0.000 | 0.680 | 0.000 | 0.000 | 0.000 | 0.885 | 0.000 | 0.000 | 0.250 | 0.250 | 0.000 | 0.000 | 0.000 | 0.000 | 0.000 | 0.000 | 0.827 |
| | 0.680 | | | | 0.885 | | | | 0.375 | | | | | | | | |
| PM | NORTHBOUND | | | | SOUTHBOUND | | | | EASTBOUND | | | | WESTBOUND | | | | TOTAL |
| | 1 NL | 2 NT | 1 NR | 0 NU | 1 SL | 2 ST | 1 SR | 0 SU | 0 EL | 1 ET | 1 ER | 0 EU | 0 WL | 1 WT | 1 WR | 0 WU | |
| 4:00 PM | 0 | 26 | 0 | 0 | 0 | 19 | 0 | 0 | 0 | 0 | 0 | 0 | 0 | 0 | 0 | 0 | 45 |
| 4:15 PM | 0 | 22 | 0 | 0 | 0 | 27 | 0 | 0 | 0 | 0 | 0 | 0 | 0 | 1 | 0 | 0 | 50 |
| 4:30 PM | 0 | 14 | 0 | 0 | 0 | 24 | 0 | 0 | 0 | 0 | 0 | 0 | 0 | 0 | 0 | 0 | 38 |
| 4:45 PM | 0 | 31 | 0 | 0 | 0 | 22 | 0 | 0 | 0 | 0 | 0 | 0 | 0 | 0 | 0 | 0 | 53 |
| 5:00 PM | 0 | 26 | 0 | 0 | 0 | 24 | 0 | 0 | 0 | 0 | 0 | 0 | 0 | 0 | 0 | 0 | 50 |
| 5:15 PM | 0 | 23 | 0 | 0 | 0 | 15 | 0 | 0 | 0 | 0 | 0 | 0 | 0 | 0 | 0 | 0 | 38 |
| 5:30 PM | 0 | 20 | 0 | 0 | 0 | 18 | 0 | 0 | 0 | 0 | 0 | 0 | 0 | 0 | 0 | 0 | 38 |
| 5:45 PM | 0 | 11 | 0 | 0 | 0 | 15 | 0 | 0 | 0 | 0 | 0 | 0 | 0 | 0 | 0 | 0 | 26 |
| 6:00 PM | 0 | 14 | 0 | 0 | 0 | 22 | 0 | 0 | 0 | 0 | 0 | 0 | 0 | 0 | 0 | 0 | 36 |
| 6:15 PM | 0 | 6 | 0 | 0 | 0 | 19 | 0 | 0 | 0 | 0 | 0 | 0 | 0 | 0 | 0 | 0 | 25 |
| 6:30 PM | 0 | 8 | 0 | 1 | 1 | 14 | 0 | 0 | 0 | 0 | 0 | 0 | 0 | 0 | 0 | 0 | 24 |
| 6:45 PM | 0 | 9 | 0 | 0 | 0 | 17 | 0 | 0 | 0 | 0 | 0 | 0 | 0 | 0 | 0 | 0 | 26 |
| TOTAL VOLUMES : | NL | NT | NR | NU | SL | ST | SR | SU | EL | ET | ER | EU | WL | WT | WR | WU | TOTAL |
| APPROACH %'s : | 0.00% | 99.53% | 0.00% | 0.47% | 0.42% | 99.58% | 0.00% | 0.00% | 0 | 0 | 0 | 0 | 0.00% | 100.00% | 0.00% | 0.00% | 449 |
| PEAK HR : | 04:45 PM - 05:45 PM | | | | | | | | | | | | | | | | TOTAL |
| PEAK HR VOL : | 0 | 100 | 0 | 0 | 0 | 79 | 0 | 0 | 0 | 0 | 0 | 0 | 0 | 0 | 0 | 0 | 179 |
| PEAK HR FACTOR : | 0.000 | 0.806 | 0.000 | 0.000 | 0.000 | 0.823 | 0.000 | 0.000 | 0.000 | 0.000 | 0.000 | 0.000 | 0.000 | 0.000 | 0.000 | 0.000 | 0.844 |
| | 0.806 | | | | 0.823 | | | | | | | | | | | | |

National Data & Surveying Services Intersection Turning Movement Count

Location: US 23/SR 365/Cornelia Hwy & Cagle Rd
 City: Lula
 Control: 2-Way Stop (EB/WB)

Project ID: 22-180056-006
 Date: 3/30/2022

Data - Bikes

| NS/EW Streets: | US 23/SR 365/Cornelia Hwy | | | | US 23/SR 365/Cornelia Hwy | | | | Cagle Rd | | | | Cagle Rd | | | | | |
|-----------------------------------|---------------------------|---------|---------|---------|---------------------------|---------|---------|---------|-----------|---------|---------|---------|-----------|---------|---------|---------|------------|-------|
| AM | NORTHBOUND | | | | SOUTHBOUND | | | | EASTBOUND | | | | WESTBOUND | | | | TOTAL | |
| | 1 NL | 2 NT | 1 NR | 0 NU | 1 SL | 2 ST | 1 SR | 0 SU | 0 EL | 1 ET | 1 ER | 0 EU | 0 WL | 1 WT | 1 WR | 0 WU | | |
| 7:00 AM | 0 | 0 | 0 | 0 | 0 | 0 | 0 | 0 | 0 | 0 | 0 | 0 | 0 | 0 | 0 | 0 | 0 | |
| 7:15 AM | 0 | 0 | 0 | 0 | 0 | 0 | 0 | 0 | 0 | 0 | 0 | 0 | 0 | 0 | 0 | 0 | 0 | |
| 7:30 AM | 0 | 0 | 0 | 0 | 0 | 0 | 0 | 0 | 0 | 0 | 0 | 0 | 0 | 0 | 0 | 0 | 0 | |
| 7:45 AM | 0 | 0 | 0 | 0 | 0 | 0 | 0 | 0 | 0 | 0 | 0 | 0 | 0 | 0 | 0 | 0 | 0 | |
| 8:00 AM | 0 | 0 | 0 | 0 | 0 | 0 | 0 | 0 | 0 | 0 | 0 | 0 | 0 | 0 | 0 | 0 | 0 | |
| 8:15 AM | 0 | 0 | 0 | 0 | 0 | 0 | 0 | 0 | 0 | 0 | 0 | 0 | 0 | 0 | 0 | 0 | 0 | |
| 8:30 AM | 0 | 0 | 0 | 0 | 0 | 0 | 0 | 0 | 0 | 0 | 0 | 0 | 0 | 0 | 0 | 0 | 0 | |
| 8:45 AM | 0 | 0 | 0 | 0 | 0 | 0 | 0 | 0 | 0 | 0 | 0 | 0 | 0 | 0 | 0 | 0 | 0 | |
| 9:00 AM | 0 | 0 | 0 | 0 | 0 | 0 | 0 | 0 | 0 | 0 | 0 | 0 | 0 | 0 | 0 | 0 | 0 | |
| 9:15 AM | 0 | 0 | 0 | 0 | 0 | 0 | 0 | 0 | 0 | 0 | 0 | 0 | 0 | 0 | 0 | 0 | 0 | |
| 9:30 AM | 0 | 0 | 0 | 0 | 0 | 0 | 0 | 0 | 0 | 0 | 0 | 0 | 0 | 0 | 0 | 0 | 0 | |
| 9:45 AM | 0 | 0 | 0 | 0 | 0 | 0 | 0 | 0 | 0 | 0 | 0 | 0 | 0 | 0 | 0 | 0 | 0 | |
| TOTAL VOLUMES : APPROACH %'s : | NL 0 | NT 0 | NR 0 | NU 0 | SL 0 | ST 0 | SR 0 | SU 0 | EL 0 | ET 0 | ER 0 | EU 0 | WL 0 | WT 0 | WR 0 | WU 0 | TOTAL 0 | |
| PEAK HR : | 07:15 AM - 08:15 AM | | | | | | | | | | | | | | | | TOTAL | |
| PEAK HR VOL : | 0 | 0 | 0 | 0 | 0 | 0 | 0 | 0 | 0 | 0 | 0 | 0 | 0 | 0 | 0 | 0 | 0 | 0 |
| PEAK HR FACTOR : | 0.000 | 0.000 | 0.000 | 0.000 | 0.000 | 0.000 | 0.000 | 0.000 | 0.000 | 0.000 | 0.000 | 0.000 | 0.000 | 0.000 | 0.000 | 0.000 | 0.000 | 0.000 |

| PM | NORTHBOUND | | | | SOUTHBOUND | | | | EASTBOUND | | | | WESTBOUND | | | | TOTAL | |
|-----------------------------------|---------------------|---------|---------|---------|------------|---------|---------|---------|-----------|---------|---------|---------|-----------|---------|---------|---------|------------|-------|
| | 1 NL | 2 NT | 1 NR | 0 NU | 1 SL | 2 ST | 1 SR | 0 SU | 0 EL | 1 ET | 1 ER | 0 EU | 0 WL | 1 WT | 1 WR | 0 WU | | |
| 4:00 PM | 0 | 0 | 0 | 0 | 0 | 0 | 0 | 0 | 0 | 0 | 0 | 0 | 0 | 0 | 0 | 0 | 0 | |
| 4:15 PM | 0 | 0 | 0 | 0 | 0 | 0 | 0 | 0 | 0 | 0 | 0 | 0 | 0 | 0 | 0 | 0 | 0 | |
| 4:30 PM | 0 | 0 | 0 | 0 | 0 | 0 | 0 | 0 | 0 | 0 | 0 | 0 | 0 | 0 | 0 | 0 | 0 | |
| 4:45 PM | 0 | 0 | 0 | 0 | 0 | 0 | 0 | 0 | 0 | 0 | 0 | 0 | 0 | 0 | 0 | 0 | 0 | |
| 5:00 PM | 0 | 0 | 0 | 0 | 0 | 0 | 0 | 0 | 0 | 0 | 0 | 0 | 0 | 0 | 0 | 0 | 0 | |
| 5:15 PM | 0 | 0 | 0 | 0 | 0 | 0 | 0 | 0 | 0 | 0 | 0 | 0 | 0 | 0 | 0 | 0 | 0 | |
| 5:30 PM | 0 | 0 | 0 | 0 | 0 | 0 | 0 | 0 | 0 | 0 | 0 | 0 | 0 | 0 | 0 | 0 | 0 | |
| 5:45 PM | 0 | 0 | 0 | 0 | 0 | 0 | 0 | 0 | 0 | 0 | 0 | 0 | 0 | 0 | 0 | 0 | 0 | |
| 6:00 PM | 0 | 0 | 0 | 0 | 0 | 0 | 0 | 0 | 0 | 0 | 0 | 0 | 0 | 0 | 0 | 0 | 0 | |
| 6:15 PM | 0 | 0 | 0 | 0 | 0 | 0 | 0 | 0 | 0 | 0 | 0 | 0 | 0 | 0 | 0 | 0 | 0 | |
| 6:30 PM | 0 | 0 | 0 | 0 | 0 | 0 | 0 | 0 | 0 | 0 | 0 | 0 | 0 | 0 | 0 | 0 | 0 | |
| 6:45 PM | 0 | 0 | 0 | 0 | 0 | 0 | 0 | 0 | 0 | 0 | 0 | 0 | 0 | 0 | 0 | 0 | 0 | |
| TOTAL VOLUMES : APPROACH %'s : | NL 0 | NT 0 | NR 0 | NU 0 | SL 0 | ST 0 | SR 0 | SU 0 | EL 0 | ET 0 | ER 0 | EU 0 | WL 0 | WT 0 | WR 0 | WU 0 | TOTAL 0 | |
| PEAK HR : | 04:45 PM - 05:45 PM | | | | | | | | | | | | | | | | TOTAL | |
| PEAK HR VOL : | 0 | 0 | 0 | 0 | 0 | 0 | 0 | 0 | 0 | 0 | 0 | 0 | 0 | 0 | 0 | 0 | 0 | 0 |
| PEAK HR FACTOR : | 0.000 | 0.000 | 0.000 | 0.000 | 0.000 | 0.000 | 0.000 | 0.000 | 0.000 | 0.000 | 0.000 | 0.000 | 0.000 | 0.000 | 0.000 | 0.000 | 0.000 | 0.000 |

US 23/SR 365/Cornelia Hwy & Cagle Rd

Peak Hour Turning Movement Count

ID: 22-180056-006
City: Lula

Day: Wednesday
Date: 3/30/2022

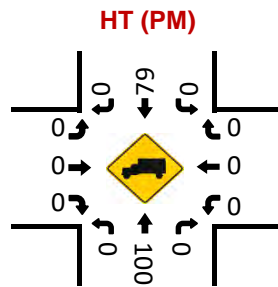
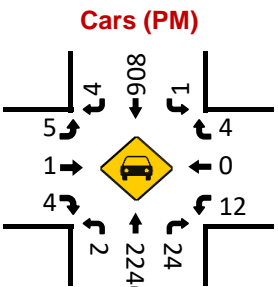
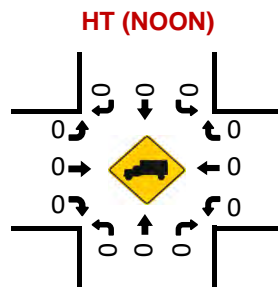
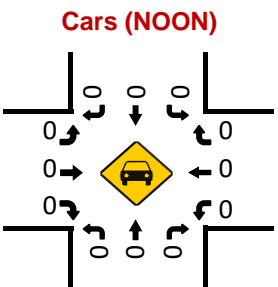
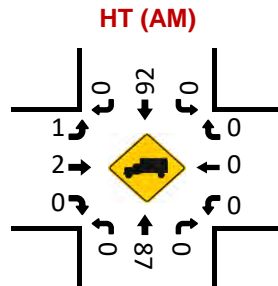
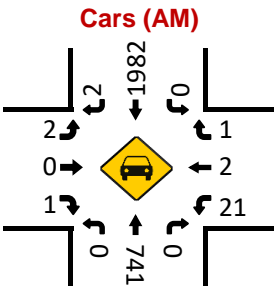
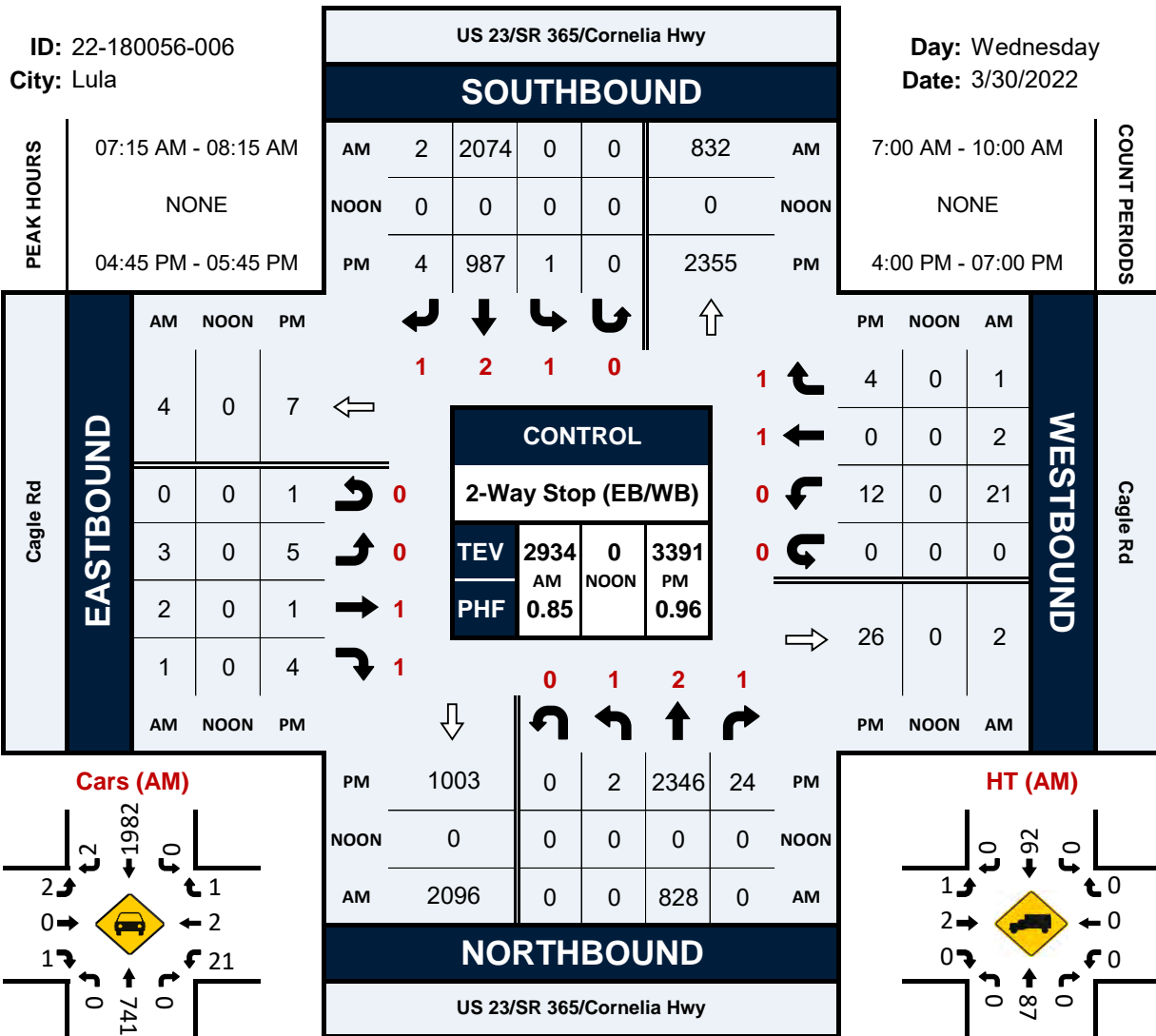

Project ID: 22-180056-006
 Location: US 23/SR 365/Cornelia Hwy & Cagle Rd
 City: Lula

Day: Wednesday
 Date: 3/30/2022

Groups Printed - Cars, PU, Vans - Heavy Trucks

| Start Time | US 23/SR 365/Cornelia Hwy Northbound | | | | | | US 23/SR 365/Cornelia Hwy Southbound | | | | | | Cagle Rd Eastbound | | | | | | Cagle Rd Westbound | | | | | | Int. Total |
|------------------|--------------------------------------|------|-------|-------|------|------------|--------------------------------------|------|-------|------|------|------------|--------------------|-------|-------|------|-------|------------|--------------------|------|------|------|------|------------|------------|
| | Left | Thru | Rgt | Utum | Peds | App. Total | Left | Thru | Rgt | Utum | Peds | App. Total | Left | Thru | Rgt | Utum | Peds | App. Total | Left | Thru | Rgt | Utum | Peds | App. Total | |
| 7:00 AM | 1 | 149 | 0 | 1 | 0 | 151 | 0 | 418 | 2 | 0 | 0 | 420 | 1 | 0 | 0 | 0 | 0 | 1 | 0 | 0 | 1 | 0 | 0 | 1 | 573 |
| 7:15 AM | 0 | 191 | 0 | 0 | 0 | 191 | 0 | 564 | 0 | 0 | 0 | 564 | 1 | 0 | 1 | 0 | 0 | 2 | 2 | 0 | 0 | 0 | 0 | 2 | 759 |
| 7:30 AM | 0 | 246 | 0 | 0 | 0 | 246 | 0 | 605 | 1 | 0 | 0 | 606 | 1 | 2 | 0 | 0 | 0 | 3 | 8 | 0 | 0 | 0 | 0 | 8 | 863 |
| 7:45 AM | 0 | 170 | 0 | 0 | 0 | 170 | 0 | 476 | 0 | 0 | 0 | 476 | 0 | 0 | 0 | 0 | 0 | 0 | 8 | 0 | 0 | 0 | 0 | 8 | 654 |
| Total | 1 | 756 | 0 | 1 | 0 | 758 | 0 | 2063 | 3 | 0 | 0 | 2066 | 3 | 2 | 1 | 0 | 0 | 6 | 18 | 0 | 1 | 0 | 0 | 19 | 2849 |
| 8:00 AM | 0 | 221 | 0 | 0 | 0 | 221 | 0 | 429 | 1 | 0 | 0 | 430 | 1 | 0 | 0 | 0 | 0 | 1 | 3 | 2 | 1 | 0 | 0 | 6 | 658 |
| 8:15 AM | 3 | 211 | 6 | 0 | 0 | 220 | 0 | 378 | 2 | 0 | 0 | 380 | 0 | 1 | 1 | 0 | 0 | 2 | 1 | 1 | 0 | 0 | 0 | 2 | 604 |
| 8:30 AM | 0 | 182 | 2 | 0 | 0 | 184 | 0 | 336 | 0 | 0 | 0 | 336 | 2 | 0 | 0 | 0 | 0 | 2 | 5 | 0 | 0 | 0 | 0 | 5 | 527 |
| 8:45 AM | 0 | 221 | 0 | 0 | 0 | 221 | 1 | 303 | 1 | 0 | 0 | 305 | 0 | 0 | 0 | 0 | 0 | 0 | 4 | 0 | 0 | 0 | 0 | 4 | 530 |
| Total | 3 | 835 | 8 | 0 | 0 | 846 | 1 | 1446 | 4 | 0 | 0 | 1451 | 3 | 1 | 1 | 0 | 0 | 5 | 13 | 3 | 1 | 0 | 0 | 17 | 2319 |
| 9:00 AM | 1 | 187 | 1 | 0 | 0 | 189 | 1 | 296 | 1 | 0 | 0 | 298 | 0 | 0 | 0 | 0 | 0 | 0 | 2 | 0 | 0 | 0 | 0 | 2 | 489 |
| 9:15 AM | 2 | 193 | 2 | 0 | 0 | 197 | 1 | 264 | 1 | 0 | 0 | 266 | 1 | 1 | 3 | 0 | 0 | 5 | 2 | 1 | 1 | 0 | 0 | 4 | 472 |
| 9:30 AM | 0 | 207 | 1 | 0 | 0 | 208 | 1 | 248 | 0 | 0 | 0 | 249 | 1 | 0 | 1 | 0 | 0 | 2 | 1 | 1 | 0 | 0 | 0 | 2 | 461 |
| 9:45 AM | 1 | 168 | 0 | 0 | 0 | 169 | 0 | 282 | 0 | 0 | 0 | 282 | 0 | 0 | 0 | 0 | 0 | 0 | 3 | 0 | 0 | 0 | 0 | 3 | 454 |
| Total | 4 | 755 | 4 | 0 | 0 | 763 | 3 | 1090 | 2 | 0 | 0 | 1095 | 2 | 1 | 4 | 0 | 0 | 7 | 8 | 2 | 1 | 0 | 0 | 11 | 1876 |
| ***BREAK*** | | | | | | | | | | | | | | | | | | | | | | | | | |
| 4:00 PM | 0 | 456 | 4 | 0 | 0 | 460 | 0 | 235 | 2 | 0 | 0 | 237 | 0 | 0 | 0 | 0 | 0 | 0 | 4 | 0 | 0 | 0 | 0 | 4 | 701 |
| 4:15 PM | 0 | 556 | 5 | 0 | 0 | 561 | 0 | 264 | 1 | 0 | 0 | 265 | 1 | 0 | 0 | 0 | 0 | 1 | 3 | 2 | 0 | 0 | 0 | 5 | 832 |
| 4:30 PM | 0 | 487 | 10 | 0 | 0 | 497 | 2 | 239 | 0 | 0 | 0 | 241 | 2 | 0 | 1 | 0 | 0 | 3 | 4 | 0 | 1 | 0 | 0 | 5 | 746 |
| 4:45 PM | 0 | 560 | 7 | 0 | 0 | 567 | 0 | 250 | 3 | 0 | 0 | 253 | 2 | 0 | 0 | 0 | 0 | 2 | 3 | 0 | 0 | 0 | 0 | 3 | 825 |
| Total | 0 | 2059 | 26 | 0 | 0 | 2085 | 2 | 988 | 6 | 0 | 0 | 996 | 5 | 0 | 1 | 0 | 0 | 6 | 14 | 2 | 1 | 0 | 0 | 17 | 3104 |
| 5:00 PM | 1 | 567 | 1 | 0 | 0 | 569 | 1 | 228 | 1 | 0 | 0 | 230 | 1 | 1 | 1 | 0 | 1 | 3 | 3 | 0 | 3 | 0 | 0 | 6 | 808 |
| 5:15 PM | 1 | 596 | 8 | 0 | 0 | 605 | 0 | 267 | 0 | 0 | 0 | 267 | 0 | 0 | 2 | 0 | 0 | 2 | 4 | 0 | 0 | 0 | 0 | 4 | 878 |
| 5:30 PM | 0 | 623 | 8 | 0 | 0 | 631 | 0 | 242 | 0 | 0 | 0 | 242 | 2 | 0 | 2 | 0 | 0 | 4 | 2 | 0 | 1 | 0 | 0 | 3 | 880 |
| 5:45 PM | 1 | 505 | 6 | 0 | 0 | 512 | 0 | 216 | 1 | 0 | 0 | 217 | 0 | 0 | 0 | 0 | 0 | 0 | 3 | 0 | 0 | 0 | 0 | 3 | 732 |
| Total | 3 | 2291 | 23 | 0 | 0 | 2317 | 1 | 953 | 2 | 0 | 0 | 956 | 3 | 1 | 4 | 1 | 0 | 9 | 12 | 0 | 4 | 0 | 0 | 16 | 3298 |
| 6:00 PM | 0 | 417 | 3 | 0 | 0 | 420 | 1 | 220 | 3 | 0 | 0 | 224 | 1 | 0 | 0 | 0 | 0 | 1 | 2 | 0 | 0 | 0 | 0 | 2 | 647 |
| 6:15 PM | 0 | 323 | 3 | 0 | 0 | 326 | 1 | 221 | 1 | 0 | 0 | 223 | 0 | 1 | 0 | 0 | 0 | 1 | 2 | 0 | 1 | 0 | 0 | 3 | 553 |
| 6:30 PM | 0 | 323 | 5 | 1 | 0 | 329 | 1 | 208 | 1 | 0 | 0 | 210 | 0 | 0 | 0 | 0 | 0 | 0 | 1 | 0 | 0 | 0 | 0 | 1 | 540 |
| 6:45 PM | 0 | 265 | 4 | 0 | 0 | 269 | 1 | 159 | 0 | 0 | 0 | 160 | 0 | 0 | 0 | 0 | 0 | 0 | 0 | 1 | 0 | 0 | 0 | 1 | 430 |
| Total | 0 | 1328 | 15 | 1 | 0 | 1344 | 4 | 808 | 5 | 0 | 0 | 817 | 1 | 1 | 0 | 0 | 0 | 2 | 5 | 1 | 1 | 0 | 0 | 7 | 2170 |
| Grand Total | 11 | 8024 | 76 | 2 | 0 | 8113 | 11 | 7348 | 22 | 0 | 0 | 7381 | 17 | 6 | 11 | 1 | 0 | 35 | 70 | 8 | 9 | 0 | 0 | 87 | 15616 |
| Apprch % | 0.1 | 98.9 | 0.9 | 0.0 | 0.0 | | 0.1 | 99.6 | 0.3 | 0.0 | 0.0 | | 48.6 | 17.1 | 31.4 | 2.9 | 0.0 | | 80.5 | 9.2 | 10.3 | 0.0 | 0.0 | | |
| Total % | 0.1 | 51.4 | 0.5 | 0.0 | 0.0 | 52.0 | 0.1 | 47.1 | 0.1 | 0.0 | 0.0 | 47.3 | 0.1 | 0.0 | 0.1 | 0.0 | 0.0 | 0.2 | 0.4 | 0.1 | 0.1 | 0.0 | 0.0 | 0.6 | |
| Cars, PU, Vans | 11 | 7513 | 76 | 0 | 0 | 7600 | 10 | 6826 | 22 | 0 | 0 | 6858 | 16 | 4 | 11 | 1 | 0 | 32 | 70 | 7 | 8 | 0 | 0 | 85 | 14575 |
| % Cars, PU, Vans | 100.0 | 93.6 | 100.0 | 0.0 | 0.0 | 93.7 | 90.9 | 92.9 | 100.0 | 0.0 | 92.9 | 94.1 | 66.7 | 100.0 | 100.0 | 91.4 | 100.0 | 87.5 | 87.5 | 88.9 | 0.0 | 0.0 | 0.0 | 97.7 | 93.3 |
| Heavy trucks | 0 | 511 | 0 | 2 | 0 | 513 | 1 | 522 | 0 | 0 | 0 | 523 | 1 | 2 | 0 | 0 | 0 | 3 | 0 | 1 | 1 | 0 | 0 | 2 | 1041 |
| % Heavy trucks | 0.0 | 6.4 | 0.0 | 100.0 | 0.0 | 6.3 | 9.1 | 7.1 | 0.0 | 0.0 | 7.1 | 5.9 | 33.3 | 0.0 | 0.0 | 8.6 | 0.0 | 12.5 | 11.1 | 0.0 | 0.0 | 0.0 | 2.3 | 6.7 | |

CLASSIFICATION

US 23/SR 365/Cornelia Hwy S/O Cagle Rd

Day: Wednesday
Date: 3/30/2022

City: Lula
Project #: GA22_180057_001

Summary

Table with columns: Time, #1-#13, Total. Rows show hourly and 15-minute volume data from 00:00 AM to 23:45.

Classification Definitions table listing vehicle types (e.g., Motorcycles, Buses, Passenger Cars) and their corresponding volume codes.

CLASSIFICATION

US 23/SR 365/Cornelia Hwy S/O Cagle Rd

Day: Wednesday

Date: 3/30/2022

City: Lula

Project #: GA22_180057_001n

North Bound

| Time | # 1 | # 2 | # 3 | # 4 | # 5 | # 6 | # 7 | # 8 | # 9 | # 10 | # 11 | # 12 | # 13 | Total |
|--------------------|-----------|--------------|-------------|-----------|------------|------------|-----------|------------|------------|-----------|-----------|------|------|--------------|
| 00:00 AM | 1 | 122 | 12 | 0 | 3 | 1 | 0 | 5 | 8 | 0 | 0 | 0 | 0 | 152 |
| 01:00 | 0 | 82 | 10 | 0 | 1 | 2 | 0 | 1 | 17 | 0 | 2 | 0 | 0 | 115 |
| 02:00 | 0 | 73 | 6 | 0 | 2 | 2 | 0 | 1 | 13 | 0 | 3 | 0 | 0 | 100 |
| 03:00 | 0 | 61 | 3 | 0 | 6 | 4 | 0 | 3 | 8 | 0 | 0 | 0 | 0 | 85 |
| 04:00 | 0 | 54 | 6 | 0 | 8 | 0 | 0 | 3 | 27 | 0 | 0 | 0 | 0 | 98 |
| 05:00 | 0 | 109 | 16 | 0 | 10 | 0 | 0 | 9 | 19 | 0 | 1 | 0 | 0 | 164 |
| 06:00 | 0 | 235 | 46 | 0 | 17 | 1 | 0 | 3 | 29 | 0 | 0 | 0 | 0 | 331 |
| 07:00 | 0 | 486 | 208 | 2 | 31 | 2 | 0 | 3 | 40 | 0 | 0 | 0 | 0 | 772 |
| 08:00 | 0 | 410 | 273 | 5 | 60 | 4 | 0 | 13 | 60 | 0 | 0 | 0 | 0 | 825 |
| 09:00 | 1 | 383 | 250 | 3 | 57 | 12 | 0 | 14 | 44 | 1 | 0 | 0 | 0 | 765 |
| 10:00 | 0 | 453 | 242 | 2 | 57 | 6 | 1 | 10 | 54 | 0 | 1 | 0 | 0 | 826 |
| 11:00 | 0 | 577 | 287 | 3 | 49 | 10 | 0 | 8 | 57 | 3 | 0 | 0 | 0 | 994 |
| 12:00 PM | 4 | 676 | 244 | 2 | 33 | 5 | 0 | 8 | 67 | 0 | 0 | 0 | 0 | 1039 |
| 13:00 | 2 | 800 | 284 | 4 | 35 | 11 | 0 | 5 | 54 | 0 | 0 | 0 | 0 | 1195 |
| 14:00 | 1 | 939 | 326 | 3 | 28 | 13 | 3 | 9 | 48 | 2 | 0 | 0 | 0 | 1372 |
| 15:00 | 1 | 1183 | 495 | 3 | 28 | 11 | 1 | 8 | 57 | 2 | 2 | 0 | 0 | 1791 |
| 16:00 | 3 | 1446 | 548 | 3 | 42 | 8 | 0 | 6 | 27 | 2 | 0 | 0 | 0 | 2085 |
| 17:00 | 1 | 1687 | 562 | 2 | 28 | 3 | 0 | 11 | 41 | 0 | 0 | 0 | 0 | 2335 |
| 18:00 | 1 | 938 | 360 | 1 | 14 | 2 | 0 | 3 | 18 | 1 | 0 | 0 | 0 | 1338 |
| 19:00 | 2 | 724 | 225 | 0 | 11 | 2 | 0 | 3 | 23 | 0 | 0 | 0 | 0 | 990 |
| 20:00 | 1 | 609 | 99 | 3 | 3 | 1 | 0 | 11 | 15 | 0 | 0 | 0 | 0 | 742 |
| 21:00 | 0 | 552 | 55 | 0 | 5 | 2 | 0 | 7 | 9 | 0 | 1 | 0 | 0 | 631 |
| 22:00 | 0 | 353 | 13 | 0 | 1 | 0 | 0 | 6 | 15 | 0 | 2 | 0 | 0 | 390 |
| 23:00 | 0 | 260 | 3 | 0 | 3 | 0 | 0 | 1 | 14 | 0 | 2 | 0 | 0 | 283 |
| Totals | 18 | 13212 | 4573 | 36 | 532 | 102 | 5 | 151 | 764 | 11 | 14 | | | 19418 |
| % of Totals | 0% | 68% | 24% | 0% | 3% | 1% | 0% | 1% | 4% | 0% | 0% | | | 100% |

| | | | | | | | | | | | | | | |
|---------------------------------|-------|---------------|-------|-------|-------|------------------|-------|-------|---------------|-------|-------|-------------------------|---|-------|
| AM Volumes | 2 | 3045 | 1359 | 15 | 301 | 44 | 1 | 73 | 376 | 4 | 7 | 0 | 0 | 5227 |
| % AM | 0% | 16% | 7% | 0% | 2% | 0% | 0% | 0% | 2% | 0% | 0% | | | 27% |
| AM Peak Hour | | 11:00 | 11:00 | 08:00 | 08:00 | 09:00 | 10:00 | 09:00 | 08:00 | 11:00 | 02:00 | | | 11:00 |
| Volume | 1 | 577 | 287 | 5 | 60 | 12 | 1 | 14 | 60 | 3 | 3 | | | 994 |
| PM Volumes | 16 | 10167 | 3214 | 21 | 231 | 58 | 4 | 78 | 388 | 7 | 7 | 0 | 0 | 14191 |
| % PM | 0% | 52% | 17% | 0% | 1% | 0% | 0% | 0% | 2% | 0% | 0% | | | 73% |
| PM Peak Hour | 12:00 | 17:00 | 17:00 | 13:00 | 16:00 | 14:00 | 14:00 | 17:00 | 12:00 | 14:00 | 15:00 | | | 17:00 |
| Volume | 4 | 1687 | 562 | 4 | 42 | 13 | 3 | 11 | 67 | 2 | 2 | | | 2335 |
| Directional Peak Periods | | AM 7-9 | | | | NOON 12-2 | | | PM 4-6 | | | Off Peak Volumes | | |
| All Classes | | Volume | | % | | Volume | | % | Volume | | % | Volume | | % |
| | | 1597 | ↔ | 8% | | 2234 | ↔ | 12% | 4420 | ↔ | 23% | 11167 | ↔ | 58% |

| Classification Definitions | | | | |
|-------------------------------|-------------------------------|----------------------------|-----------------------------|----------------------------|
| 1 Motorcycles | 4 Buses | 7 >=4-Axle Single Units | 10 >=6-Axle Single Trailers | 13 >=7-Axle Multi-Trailers |
| 2 Passenger Cars | 5 2-Axle, 6-Tire Single Units | 8 <=4-Axle Single Trailers | 11 <=5-Axle Multi-Trailers | |
| 3 2-Axle, 4-Tire Single Units | 6 3-Axle Single Units | 9 5-Axle Single Trailers | 12 6-Axle Multi-Trailers | |

CLASSIFICATION

US 23/SR 365/Cornelia Hwy S/O Cagle Rd

Day: Wednesday

Date: 3/30/2022

City: Lula

Project #: GA22_180057_001s

South Bound

| Time | # 1 | # 2 | # 3 | # 4 | # 5 | # 6 | # 7 | # 8 | # 9 | # 10 | # 11 | # 12 | # 13 | Total |
|--------------------|-----------|--------------|-------------|-----------|------------|-----------|-----|-----------|------------|-----------|-----------|-----------|------|--------------|
| 00:00 AM | 0 | 60 | 2 | 0 | 3 | 0 | 0 | 2 | 11 | 0 | 0 | 0 | 0 | 78 |
| 01:00 | 0 | 45 | 2 | 0 | 1 | 0 | 0 | 0 | 13 | 0 | 1 | 0 | 0 | 62 |
| 02:00 | 0 | 54 | 3 | 0 | 2 | 0 | 0 | 1 | 17 | 0 | 0 | 0 | 0 | 77 |
| 03:00 | 0 | 111 | 2 | 0 | 4 | 0 | 0 | 1 | 13 | 0 | 0 | 0 | 0 | 131 |
| 04:00 | 0 | 319 | 4 | 0 | 5 | 0 | 0 | 5 | 19 | 0 | 0 | 0 | 0 | 352 |
| 05:00 | 0 | 869 | 18 | 0 | 11 | 0 | 0 | 3 | 11 | 0 | 0 | 0 | 0 | 912 |
| 06:00 | 0 | 1531 | 13 | 5 | 14 | 0 | 0 | 3 | 27 | 0 | 1 | 0 | 0 | 1594 |
| 07:00 | 0 | 1671 | 377 | 1 | 32 | 1 | 0 | 1 | 30 | 0 | 0 | 0 | 0 | 2113 |
| 08:00 | 0 | 1026 | 299 | 6 | 38 | 4 | 0 | 5 | 43 | 0 | 0 | 1 | 0 | 1422 |
| 09:00 | 1 | 778 | 232 | 0 | 28 | 3 | 0 | 5 | 53 | 0 | 0 | 0 | 0 | 1100 |
| 10:00 | 1 | 743 | 258 | 1 | 26 | 8 | 0 | 2 | 54 | 0 | 0 | 0 | 0 | 1093 |
| 11:00 | 2 | 630 | 232 | 0 | 31 | 11 | 0 | 5 | 61 | 0 | 0 | 0 | 0 | 972 |
| 12:00 PM | 2 | 743 | 203 | 3 | 27 | 5 | 0 | 4 | 53 | 1 | 0 | 0 | 0 | 1041 |
| 13:00 | 2 | 795 | 171 | 5 | 25 | 4 | 0 | 7 | 54 | 0 | 0 | 0 | 0 | 1063 |
| 14:00 | 3 | 761 | 202 | 3 | 32 | 4 | 0 | 3 | 48 | 0 | 0 | 0 | 0 | 1056 |
| 15:00 | 1 | 691 | 225 | 3 | 26 | 3 | 0 | 4 | 61 | 2 | 0 | 0 | 0 | 1016 |
| 16:00 | 3 | 746 | 188 | 1 | 33 | 1 | 0 | 7 | 38 | 0 | 0 | 0 | 0 | 1017 |
| 17:00 | 0 | 742 | 181 | 2 | 25 | 1 | 0 | 9 | 31 | 0 | 0 | 0 | 0 | 991 |
| 18:00 | 3 | 567 | 185 | 1 | 31 | 2 | 0 | 3 | 30 | 0 | 0 | 0 | 0 | 822 |
| 19:00 | 6 | 401 | 146 | 1 | 11 | 6 | 0 | 1 | 28 | 0 | 0 | 0 | 0 | 600 |
| 20:00 | 0 | 366 | 27 | 0 | 15 | 2 | 0 | 7 | 16 | 0 | 1 | 0 | 0 | 434 |
| 21:00 | 0 | 297 | 3 | 1 | 5 | 0 | 0 | 4 | 18 | 0 | 0 | 0 | 0 | 328 |
| 22:00 | 0 | 185 | 1 | 0 | 0 | 0 | 0 | 5 | 8 | 0 | 0 | 0 | 0 | 199 |
| 23:00 | 0 | 110 | 0 | 0 | 2 | 0 | 0 | 6 | 5 | 0 | 0 | 0 | 0 | 123 |
| Totals | 24 | 14241 | 2974 | 33 | 427 | 55 | | 93 | 742 | 3 | 3 | 1 | | 18596 |
| % of Totals | 0% | 77% | 16% | 0% | 2% | 0% | | 1% | 4% | 0% | 0% | 0% | | 100% |

| | | | | | | | | | | | | | | |
|---------------------------------|--------|-------|---------------|-------|--------|------------------|-----|--------|---------------|-------|--------|-------------------------|-----|-------|
| AM Volumes | 4 | 7837 | 1442 | 13 | 195 | 27 | 0 | 33 | 352 | 0 | 2 | 1 | 0 | 9906 |
| % AM | 0% | 42% | 8% | 0% | 1% | 0% | | 0% | 2% | | 0% | 0% | | 53% |
| AM Peak Hour | 11:00 | 07:00 | 07:00 | 08:00 | 08:00 | 11:00 | | 04:00 | 11:00 | | 01:00 | 08:00 | | 07:00 |
| Volume | 2 | 1671 | 377 | 6 | 38 | 11 | | 5 | 61 | | 1 | 1 | | 2113 |
| PM Volumes | 20 | 6404 | 1532 | 20 | 232 | 28 | 0 | 60 | 390 | 3 | 1 | 0 | 0 | 8690 |
| % PM | 0% | 34% | 8% | 0% | 1% | 0% | | 0% | 2% | 0% | 0% | | | 47% |
| PM Peak Hour | 19:00 | 13:00 | 15:00 | 13:00 | 16:00 | 19:00 | | 17:00 | 15:00 | 15:00 | 20:00 | | | 13:00 |
| Volume | 6 | 795 | 225 | 5 | 33 | 6 | | 9 | 61 | 2 | 1 | | | 1063 |
| Directional Peak Periods | | | AM 7-9 | | | NOON 12-2 | | | PM 4-6 | | | Off Peak Volumes | | |
| All Classes | Volume | | % | | Volume | | % | Volume | | % | Volume | | % | |
| | 3535 | ↔ | 19% | | 2104 | ↔ | 11% | 2008 | ↔ | 11% | 10949 | ↔ | 59% | |

Classification Definitions

| | | | | |
|-------------------------------|-------------------------------|----------------------------|-----------------------------|----------------------------|
| 1 Motorcycles | 4 Buses | 7 >=4-Axle Single Units | 10 >=6-Axle Single Trailers | 13 >=7-Axle Multi-Trailers |
| 2 Passenger Cars | 5 2-Axle, 6-Tire Single Units | 8 <=4-Axle Single Trailers | 11 <=5-Axle Multi-Trailers | |
| 3 2-Axle, 4-Tire Single Units | 6 3-Axle Single Units | 9 5-Axle Single Trailers | 12 6-Axle Multi-Trailers | |

CLASSIFICATION

US 23/SR 365/Cornelia Hwy S/O Cagle Rd

Day: Wednesday

Date: 3/30/2022

City: Lula

Project #: GA22_180057_001

Summary

| Time | # 1 | # 2 | # 3 | # 4 | # 5 | # 6 | # 7 | # 8 | # 9 | # 10 | # 11 | # 12 | # 13 | Total |
|--------------------|-----------|--------------|-------------|-----------|------------|------------|-----------|------------|-------------|-----------|-----------|-----------|------|--------------|
| 00:00 AM | 1 | 182 | 14 | 0 | 6 | 1 | 0 | 7 | 19 | 0 | 0 | 0 | 0 | 230 |
| 01:00 | 0 | 127 | 12 | 0 | 2 | 2 | 0 | 1 | 30 | 0 | 3 | 0 | 0 | 177 |
| 02:00 | 0 | 127 | 9 | 0 | 4 | 2 | 0 | 2 | 30 | 0 | 3 | 0 | 0 | 177 |
| 03:00 | 0 | 172 | 5 | 0 | 10 | 4 | 0 | 4 | 21 | 0 | 0 | 0 | 0 | 216 |
| 04:00 | 0 | 373 | 10 | 0 | 13 | 0 | 0 | 8 | 46 | 0 | 0 | 0 | 0 | 450 |
| 05:00 | 0 | 978 | 34 | 0 | 21 | 0 | 0 | 12 | 30 | 0 | 1 | 0 | 0 | 1076 |
| 06:00 | 0 | 1766 | 59 | 5 | 31 | 1 | 0 | 6 | 56 | 0 | 1 | 0 | 0 | 1925 |
| 07:00 | 0 | 2157 | 585 | 3 | 63 | 3 | 0 | 4 | 70 | 0 | 0 | 0 | 0 | 2885 |
| 08:00 | 0 | 1436 | 572 | 11 | 98 | 8 | 0 | 18 | 103 | 0 | 0 | 1 | 0 | 2247 |
| 09:00 | 2 | 1161 | 482 | 3 | 85 | 15 | 0 | 19 | 97 | 1 | 0 | 0 | 0 | 1865 |
| 10:00 | 1 | 1196 | 500 | 3 | 83 | 14 | 1 | 12 | 108 | 0 | 1 | 0 | 0 | 1919 |
| 11:00 | 2 | 1207 | 519 | 3 | 80 | 21 | 0 | 13 | 118 | 3 | 0 | 0 | 0 | 1966 |
| 12:00 PM | 6 | 1419 | 447 | 5 | 60 | 10 | 0 | 12 | 120 | 1 | 0 | 0 | 0 | 2080 |
| 13:00 | 4 | 1595 | 455 | 9 | 60 | 15 | 0 | 12 | 108 | 0 | 0 | 0 | 0 | 2258 |
| 14:00 | 4 | 1700 | 528 | 6 | 60 | 17 | 3 | 12 | 96 | 2 | 0 | 0 | 0 | 2428 |
| 15:00 | 2 | 1874 | 720 | 6 | 54 | 14 | 1 | 12 | 118 | 4 | 2 | 0 | 0 | 2807 |
| 16:00 | 6 | 2192 | 736 | 4 | 75 | 9 | 0 | 13 | 65 | 2 | 0 | 0 | 0 | 3102 |
| 17:00 | 1 | 2429 | 743 | 4 | 53 | 4 | 0 | 20 | 72 | 0 | 0 | 0 | 0 | 3326 |
| 18:00 | 4 | 1505 | 545 | 2 | 45 | 4 | 0 | 6 | 48 | 1 | 0 | 0 | 0 | 2160 |
| 19:00 | 8 | 1125 | 371 | 1 | 22 | 8 | 0 | 4 | 51 | 0 | 0 | 0 | 0 | 1590 |
| 20:00 | 1 | 975 | 126 | 3 | 18 | 3 | 0 | 18 | 31 | 0 | 1 | 0 | 0 | 1176 |
| 21:00 | 0 | 849 | 58 | 1 | 10 | 2 | 0 | 11 | 27 | 0 | 1 | 0 | 0 | 959 |
| 22:00 | 0 | 538 | 14 | 0 | 1 | 0 | 0 | 11 | 23 | 0 | 2 | 0 | 0 | 589 |
| 23:00 | 0 | 370 | 3 | 0 | 5 | 0 | 0 | 7 | 19 | 0 | 2 | 0 | 0 | 406 |
| Totals | 42 | 27453 | 7547 | 69 | 959 | 157 | 5 | 244 | 1506 | 14 | 17 | 1 | | 38014 |
| % of Totals | 0% | 72% | 20% | 0% | 3% | 0% | 0% | 1% | 4% | 0% | 0% | 0% | | 100% |

| | | | | | | | | | | | | | | | |
|---------------------------------|---------------|-------|-------|-------|------------------|-------|-------|-------|---------------|-------|-------|-------|-------------------------|-------|--|
| AM Volumes | 6 | 10882 | 2801 | 28 | 496 | 71 | 1 | 106 | 728 | 4 | 9 | 1 | 0 | 15133 | |
| % AM | 0% | 29% | 7% | 0% | 1% | 0% | 0% | 0% | 2% | 0% | 0% | 0% | | 40% | |
| AM Peak Hour | 09:00 | 07:00 | 07:00 | 08:00 | 08:00 | 11:00 | 10:00 | 09:00 | 11:00 | 11:00 | 01:00 | 08:00 | | 07:00 | |
| Volume | 2 | 2157 | 585 | 11 | 98 | 21 | 1 | 19 | 118 | 3 | 3 | 1 | | 2885 | |
| PM Volumes | 36 | 16571 | 4746 | 41 | 463 | 86 | 4 | 138 | 778 | 10 | 8 | 0 | 0 | 22881 | |
| % PM | 0% | 44% | 12% | 0% | 1% | 0% | 0% | 0% | 2% | 0% | 0% | | | 60% | |
| PM Peak Hour | 19:00 | 17:00 | 17:00 | 13:00 | 16:00 | 14:00 | 14:00 | 17:00 | 12:00 | 15:00 | 15:00 | | | 17:00 | |
| Volume | 8 | 2429 | 743 | 9 | 75 | 17 | 3 | 20 | 120 | 4 | 2 | | | 3326 | |
| Directional Peak Periods | AM 7-9 | | | | NOON 12-2 | | | | PM 4-6 | | | | Off Peak Volumes | | |
| All Classes | Volume | ↔ | | % | Volume | ↔ | | % | Volume | ↔ | | % | Volume | ↔ | |
| | 5132 | | | 14% | 4338 | | | 11% | 6428 | | | 17% | 22116 | | |

| Classification Definitions | | | | |
|-------------------------------|-------------------------------|----------------------------|-----------------------------|----------------------------|
| 1 Motorcycles | 4 Buses | 7 >=4-Axle Single Units | 10 >=6-Axle Single Trailers | 13 >=7-Axle Multi-Trailers |
| 2 Passenger Cars | 5 2-Axle, 6-Tire Single Units | 8 <=4-Axle Single Trailers | 11 <=5-Axle Multi-Trailers | |
| 3 2-Axle, 4-Tire Single Units | 6 3-Axle Single Units | 9 5-Axle Single Trailers | 12 6-Axle Multi-Trailers | |

VOLUME

US 23/SR 365/Cornelia Hwy S/O Cagle Rd

Day: Wednesday
 Date: 3/30/2022

City: Lula
 Project #: GA22_180057_001

| DAILY TOTALS | | | | | | NB | SB | EB | WB | Total | |
|----------------|-------|-------|-----|------|-------|----------------|--------|-------|-----|--------|-------|
| | | | | | | 19,418 | 18,596 | 0 | 0 | 38,014 | |
| AM Period | NB | SB | EB | WB | TOTAL | PM Period | NB | SB | EB | WB | TOTAL |
| 00:00 | 43 | 17 | 0 | 0 | 60 | 12:00 | 259 | 261 | 0 | 0 | 520 |
| 00:15 | 28 | 26 | 0 | 0 | 54 | 12:15 | 248 | 271 | 0 | 0 | 519 |
| 00:30 | 43 | 26 | 0 | 0 | 69 | 12:30 | 247 | 241 | 0 | 0 | 488 |
| 00:45 | 38 | 152 | 9 | 78 | 47 | 12:45 | 285 | 1039 | 268 | 1041 | 553 |
| 01:00 | 26 | 24 | 0 | 0 | 50 | 13:00 | 296 | 271 | 0 | 0 | 567 |
| 01:15 | 28 | 13 | 0 | 0 | 41 | 13:15 | 299 | 274 | 0 | 0 | 573 |
| 01:30 | 29 | 14 | 0 | 0 | 43 | 13:30 | 295 | 271 | 0 | 0 | 566 |
| 01:45 | 32 | 115 | 11 | 62 | 43 | 13:45 | 305 | 1195 | 247 | 1063 | 552 |
| 02:00 | 22 | 15 | 0 | 0 | 37 | 14:00 | 288 | 248 | 0 | 0 | 536 |
| 02:15 | 27 | 23 | 0 | 0 | 50 | 14:15 | 344 | 273 | 0 | 0 | 617 |
| 02:30 | 21 | 18 | 0 | 0 | 39 | 14:30 | 356 | 286 | 0 | 0 | 642 |
| 02:45 | 30 | 100 | 21 | 77 | 51 | 14:45 | 384 | 1372 | 249 | 1056 | 633 |
| 03:00 | 16 | 23 | 0 | 0 | 39 | 15:00 | 399 | 242 | 0 | 0 | 641 |
| 03:15 | 29 | 23 | 0 | 0 | 52 | 15:15 | 426 | 267 | 0 | 0 | 693 |
| 03:30 | 22 | 42 | 0 | 0 | 64 | 15:30 | 468 | 247 | 0 | 0 | 715 |
| 03:45 | 18 | 85 | 43 | 131 | 61 | 15:45 | 498 | 1791 | 260 | 1016 | 758 |
| 04:00 | 18 | 48 | 0 | 0 | 66 | 16:00 | 464 | 239 | 0 | 0 | 703 |
| 04:15 | 17 | 74 | 0 | 0 | 91 | 16:15 | 553 | 268 | 0 | 0 | 821 |
| 04:30 | 35 | 121 | 0 | 0 | 156 | 16:30 | 494 | 243 | 0 | 0 | 737 |
| 04:45 | 28 | 98 | 109 | 352 | 137 | 16:45 | 574 | 2085 | 267 | 1017 | 841 |
| 05:00 | 25 | 133 | 0 | 0 | 158 | 17:00 | 576 | 239 | 0 | 0 | 815 |
| 05:15 | 35 | 209 | 0 | 0 | 244 | 17:15 | 599 | 286 | 0 | 0 | 885 |
| 05:30 | 52 | 286 | 0 | 0 | 338 | 17:30 | 630 | 245 | 0 | 0 | 875 |
| 05:45 | 52 | 164 | 284 | 912 | 336 | 17:45 | 530 | 2335 | 221 | 991 | 751 |
| 06:00 | 73 | 361 | 0 | 0 | 434 | 18:00 | 410 | 229 | 0 | 0 | 639 |
| 06:15 | 80 | 426 | 0 | 0 | 506 | 18:15 | 318 | 221 | 0 | 0 | 539 |
| 06:30 | 83 | 432 | 0 | 0 | 515 | 18:30 | 339 | 210 | 0 | 0 | 549 |
| 06:45 | 95 | 331 | 375 | 1594 | 470 | 18:45 | 271 | 1338 | 162 | 822 | 433 |
| 07:00 | 154 | 428 | 0 | 0 | 582 | 19:00 | 260 | 168 | 0 | 0 | 428 |
| 07:15 | 204 | 618 | 0 | 0 | 822 | 19:15 | 258 | 160 | 0 | 0 | 418 |
| 07:30 | 240 | 605 | 0 | 0 | 845 | 19:30 | 248 | 149 | 0 | 0 | 397 |
| 07:45 | 174 | 772 | 462 | 2113 | 636 | 19:45 | 224 | 990 | 123 | 600 | 347 |
| 08:00 | 219 | 393 | 0 | 0 | 612 | 20:00 | 214 | 120 | 0 | 0 | 334 |
| 08:15 | 212 | 395 | 0 | 0 | 607 | 20:15 | 197 | 118 | 0 | 0 | 315 |
| 08:30 | 181 | 337 | 0 | 0 | 518 | 20:30 | 179 | 115 | 0 | 0 | 294 |
| 08:45 | 213 | 825 | 297 | 1422 | 510 | 20:45 | 152 | 742 | 81 | 434 | 233 |
| 09:00 | 193 | 292 | 0 | 0 | 485 | 21:00 | 172 | 88 | 0 | 0 | 260 |
| 09:15 | 193 | 268 | 0 | 0 | 461 | 21:15 | 172 | 88 | 0 | 0 | 260 |
| 09:30 | 201 | 257 | 0 | 0 | 458 | 21:30 | 157 | 78 | 0 | 0 | 235 |
| 09:45 | 178 | 765 | 283 | 1100 | 461 | 21:45 | 130 | 631 | 74 | 328 | 204 |
| 10:00 | 183 | 262 | 0 | 0 | 445 | 22:00 | 115 | 64 | 0 | 0 | 179 |
| 10:15 | 205 | 283 | 0 | 0 | 488 | 22:15 | 103 | 57 | 0 | 0 | 160 |
| 10:30 | 224 | 282 | 0 | 0 | 506 | 22:30 | 106 | 47 | 0 | 0 | 153 |
| 10:45 | 214 | 826 | 266 | 1093 | 480 | 22:45 | 66 | 390 | 31 | 199 | 97 |
| 11:00 | 222 | 245 | 0 | 0 | 467 | 23:00 | 78 | 33 | 0 | 0 | 111 |
| 11:15 | 247 | 244 | 0 | 0 | 491 | 23:15 | 85 | 32 | 0 | 0 | 117 |
| 11:30 | 268 | 264 | 0 | 0 | 532 | 23:30 | 66 | 32 | 0 | 0 | 98 |
| 11:45 | 257 | 994 | 219 | 972 | 476 | 23:45 | 54 | 283 | 26 | 123 | 80 |
| TOTALS | 5227 | 9906 | | | 15133 | TOTALS | 14191 | 8690 | | | 22881 |
| SPLIT % | 34.5% | 65.5% | | | 39.8% | SPLIT % | 62.0% | 38.0% | | | 60.2% |

| DAILY TOTALS | | | | | | NB | SB | EB | WB | Total |
|-----------------|-------|-------|-------|-------|-------|-----------------|--------|-------|-------|--------|
| | | | | | | 19,418 | 18,596 | 0 | 0 | 38,014 |
| AM Peak Hour | 11:30 | 07:00 | | | 07:15 | PM Peak Hour | 16:45 | 12:45 | | 16:45 |
| AM Pk Volume | 1032 | 2113 | | | 2915 | PM Pk Volume | 2379 | 1084 | | 3416 |
| Pk Hr Factor | 0.963 | 0.855 | | | 0.862 | Pk Hr Factor | 0.944 | 0.989 | | 0.965 |
| 7 - 9 Volume | 1597 | 3535 | 0 | 0 | 5132 | 4 - 6 Volume | 4420 | 2008 | 0 | 6428 |
| 7 - 9 Peak Hour | 07:30 | 07:00 | | | 07:15 | 4 - 6 Peak Hour | 16:45 | 16:45 | | 16:45 |
| 7 - 9 Pk Volume | 845 | 2113 | 0 | 0 | 2915 | 4 - 6 Pk Volume | 2379 | 1037 | 0 | 3416 |
| Pk Hr Factor | 0.880 | 0.855 | 0.000 | 0.000 | 0.862 | Pk Hr Factor | 0.944 | 0.906 | 0.000 | 0.965 |

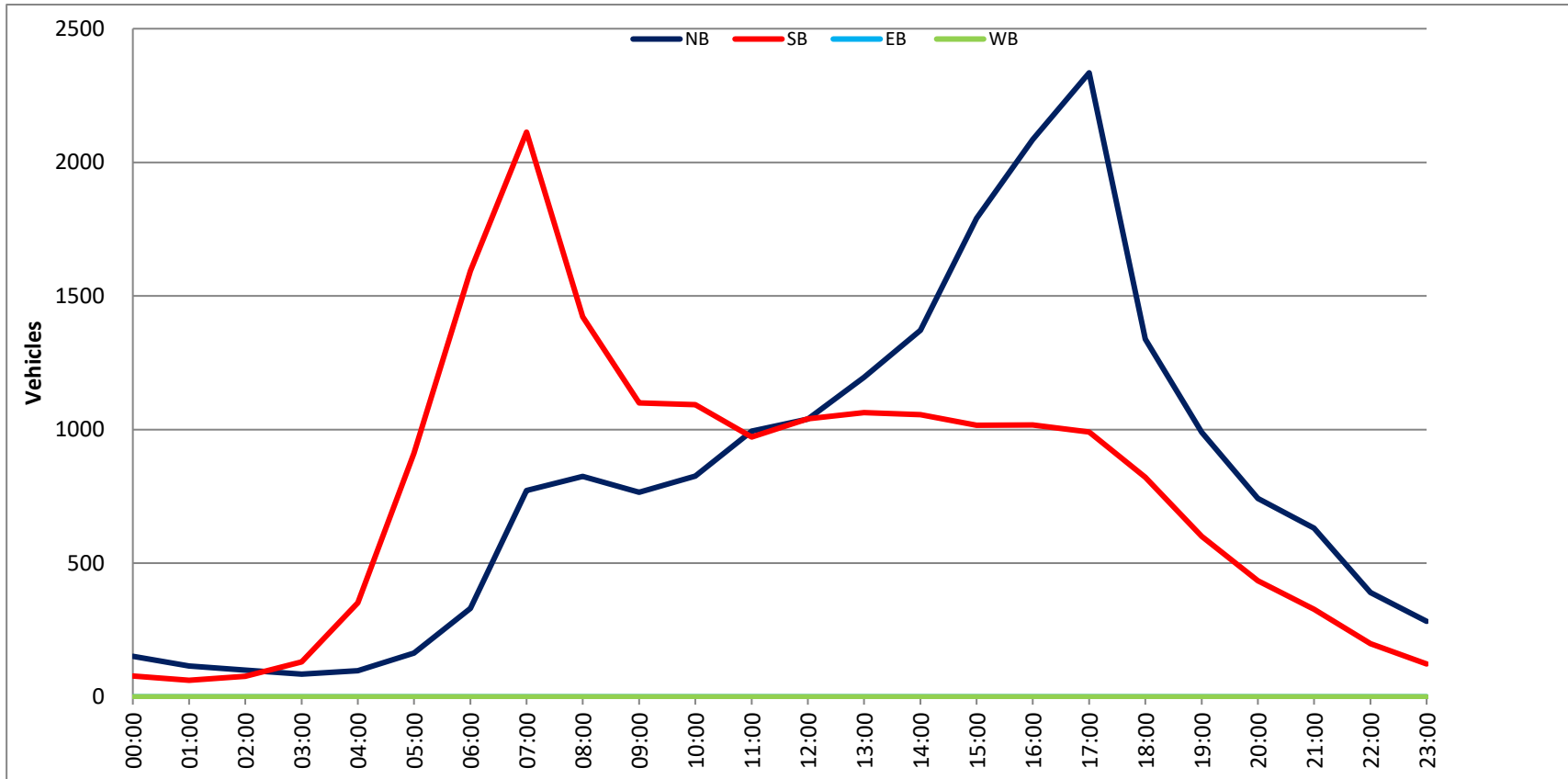

CLASSIFICATION

Old Cornelia Hwy W/O Hyde Mill Rd

Day: Wednesday

Date: 3/30/2022

City: Lula

Project #: GA22_180057_002e

East Bound

| Time | # 1 | # 2 | # 3 | # 4 | # 5 | # 6 | # 7 | # 8 | # 9 | # 10 | # 11 | # 12 | # 13 | Total |
|--------------------|-----------|-------------|------------|-----------|-----------|-----------|-----|-----------|-----------|-----------|------|------|------|-------------|
| 00:00 AM | 0 | 14 | 0 | 0 | 0 | 0 | 0 | 0 | 0 | 0 | 0 | 0 | 0 | 14 |
| 01:00 | 0 | 5 | 2 | 0 | 0 | 0 | 0 | 0 | 2 | 0 | 0 | 0 | 0 | 9 |
| 02:00 | 0 | 6 | 1 | 0 | 0 | 0 | 0 | 0 | 0 | 0 | 0 | 0 | 0 | 7 |
| 03:00 | 0 | 5 | 2 | 0 | 0 | 0 | 0 | 0 | 2 | 0 | 0 | 0 | 0 | 9 |
| 04:00 | 0 | 3 | 1 | 0 | 0 | 0 | 0 | 0 | 0 | 0 | 0 | 0 | 0 | 4 |
| 05:00 | 1 | 3 | 2 | 0 | 0 | 0 | 0 | 0 | 1 | 0 | 0 | 0 | 0 | 7 |
| 06:00 | 0 | 26 | 3 | 0 | 3 | 0 | 0 | 0 | 0 | 0 | 0 | 0 | 0 | 32 |
| 07:00 | 0 | 45 | 12 | 0 | 4 | 0 | 0 | 1 | 1 | 0 | 0 | 0 | 0 | 63 |
| 08:00 | 0 | 72 | 19 | 0 | 7 | 0 | 0 | 0 | 0 | 0 | 0 | 0 | 0 | 98 |
| 09:00 | 0 | 44 | 14 | 0 | 3 | 0 | 0 | 0 | 0 | 0 | 0 | 0 | 0 | 61 |
| 10:00 | 0 | 48 | 17 | 0 | 4 | 0 | 0 | 0 | 0 | 0 | 0 | 0 | 0 | 69 |
| 11:00 | 0 | 70 | 25 | 0 | 3 | 0 | 0 | 1 | 0 | 0 | 0 | 0 | 0 | 99 |
| 12:00 PM | 0 | 100 | 23 | 0 | 2 | 2 | 0 | 0 | 2 | 0 | 0 | 0 | 0 | 129 |
| 13:00 | 2 | 106 | 30 | 0 | 2 | 2 | 0 | 2 | 0 | 0 | 0 | 0 | 0 | 144 |
| 14:00 | 2 | 91 | 29 | 1 | 6 | 0 | 0 | 0 | 0 | 0 | 0 | 0 | 0 | 129 |
| 15:00 | 2 | 166 | 58 | 2 | 6 | 0 | 0 | 1 | 0 | 1 | 0 | 0 | 0 | 236 |
| 16:00 | 0 | 210 | 48 | 2 | 5 | 2 | 0 | 0 | 0 | 0 | 0 | 0 | 0 | 267 |
| 17:00 | 3 | 234 | 50 | 0 | 3 | 1 | 0 | 1 | 2 | 0 | 0 | 0 | 0 | 294 |
| 18:00 | 2 | 162 | 34 | 0 | 1 | 1 | 0 | 0 | 0 | 0 | 0 | 0 | 0 | 200 |
| 19:00 | 0 | 90 | 17 | 0 | 1 | 0 | 0 | 0 | 0 | 0 | 0 | 0 | 0 | 108 |
| 20:00 | 0 | 103 | 26 | 0 | 0 | 1 | 0 | 0 | 1 | 0 | 0 | 0 | 0 | 131 |
| 21:00 | 0 | 52 | 10 | 0 | 1 | 0 | 0 | 0 | 0 | 0 | 0 | 0 | 0 | 63 |
| 22:00 | 0 | 42 | 6 | 0 | 1 | 0 | 0 | 0 | 0 | 0 | 0 | 0 | 0 | 49 |
| 23:00 | 0 | 27 | 1 | 0 | 1 | 0 | 0 | 0 | 0 | 0 | 0 | 0 | 0 | 29 |
| Totals | 12 | 1724 | 430 | 5 | 53 | 9 | | 6 | 11 | 1 | | | | 2251 |
| % of Totals | 1% | 77% | 19% | 0% | 2% | 0% | | 0% | 0% | 0% | | | | 100% |

| | | | | | | | | | | | | | | |
|---------------------------------|---------------|-------|-------|-------|--------|------------------|-----|--------|---------------|-------|--------|-------------------------|---|-------|
| AM Volumes | 1 | 341 | 98 | 0 | 24 | 0 | 0 | 2 | 6 | 0 | 0 | 0 | 0 | 472 |
| % AM | 0% | 15% | 4% | | 1% | | | 0% | 0% | | | | | 21% |
| AM Peak Hour | 05:00 | 08:00 | 11:00 | | 08:00 | | | 07:00 | 01:00 | | | | | 11:00 |
| Volume | 1 | 72 | 25 | | 7 | | | 1 | 2 | | | | | 99 |
| PM Volumes | 11 | 1383 | 332 | 5 | 29 | 9 | 0 | 4 | 5 | 1 | 0 | 0 | 0 | 1779 |
| % PM | 0% | 61% | 15% | 0% | 1% | 0% | | 0% | 0% | 0% | | | | 79% |
| PM Peak Hour | 17:00 | 17:00 | 15:00 | 15:00 | 14:00 | 12:00 | | 13:00 | 12:00 | 15:00 | | | | 17:00 |
| Volume | 3 | 234 | 58 | 2 | 6 | 2 | | 2 | 2 | 1 | | | | 294 |
| Directional Peak Periods | AM 7-9 | | | | | NOON 12-2 | | | PM 4-6 | | | Off Peak Volumes | | |
| All Classes | Volume | | | % | Volume | | % | Volume | | % | Volume | | % | |
| | 161 | ↔ | 7% | 273 | ↔ | 12% | 561 | ↔ | 25% | 1256 | ↔ | 56% | | |

Classification Definitions

| | | | | |
|-------------------------------|-------------------------------|----------------------------|-----------------------------|----------------------------|
| 1 Motorcycles | 4 Buses | 7 >=4-Axle Single Units | 10 >=6-Axle Single Trailers | 13 >=7-Axle Multi-Trailers |
| 2 Passenger Cars | 5 2-Axle, 6-Tire Single Units | 8 <=4-Axle Single Trailers | 11 <=5-Axle Multi-Trailers | |
| 3 2-Axle, 4-Tire Single Units | 6 3-Axle Single Units | 9 5-Axle Single Trailers | 12 6-Axle Multi-Trailers | |

CLASSIFICATION

Old Cornelia Hwy W/O Hyde Mill Rd

Day: Wednesday

Date: 3/30/2022

City: Lula

Project #: GA22_180057_002w

West Bound

| Time | # 1 | # 2 | # 3 | # 4 | # 5 | # 6 | # 7 | # 8 | # 9 | # 10 | # 11 | # 12 | # 13 | Total |
|--------------------|-----------|-------------|------------|-----------|-----------|-----------|-----|-----------|-----------|-----------|------|------|------|-------------|
| 00:00 AM | 0 | 6 | 0 | 0 | 0 | 0 | 0 | 0 | 0 | 0 | 0 | 0 | 0 | 6 |
| 01:00 | 0 | 3 | 1 | 0 | 0 | 0 | 0 | 0 | 1 | 0 | 0 | 0 | 0 | 5 |
| 02:00 | 0 | 2 | 1 | 0 | 0 | 0 | 0 | 1 | 1 | 0 | 0 | 0 | 0 | 5 |
| 03:00 | 0 | 4 | 4 | 0 | 0 | 1 | 0 | 0 | 1 | 0 | 0 | 0 | 0 | 10 |
| 04:00 | 0 | 13 | 10 | 0 | 1 | 0 | 0 | 1 | 0 | 0 | 0 | 0 | 0 | 25 |
| 05:00 | 1 | 59 | 22 | 0 | 3 | 1 | 0 | 0 | 1 | 0 | 0 | 0 | 0 | 87 |
| 06:00 | 2 | 134 | 40 | 2 | 7 | 1 | 0 | 0 | 0 | 0 | 0 | 0 | 0 | 186 |
| 07:00 | 0 | 270 | 59 | 3 | 5 | 0 | 0 | 0 | 0 | 0 | 0 | 0 | 0 | 337 |
| 08:00 | 0 | 166 | 42 | 2 | 4 | 0 | 0 | 1 | 1 | 0 | 0 | 0 | 0 | 216 |
| 09:00 | 0 | 96 | 27 | 1 | 2 | 1 | 0 | 1 | 1 | 0 | 0 | 0 | 0 | 129 |
| 10:00 | 0 | 71 | 23 | 0 | 4 | 0 | 0 | 0 | 1 | 0 | 0 | 0 | 0 | 99 |
| 11:00 | 0 | 57 | 26 | 2 | 7 | 0 | 0 | 0 | 0 | 0 | 0 | 0 | 0 | 92 |
| 12:00 PM | 0 | 78 | 31 | 0 | 6 | 1 | 0 | 2 | 3 | 0 | 0 | 0 | 0 | 121 |
| 13:00 | 1 | 63 | 24 | 1 | 5 | 0 | 0 | 2 | 0 | 0 | 0 | 0 | 0 | 96 |
| 14:00 | 1 | 116 | 24 | 1 | 4 | 1 | 0 | 0 | 1 | 0 | 0 | 0 | 0 | 148 |
| 15:00 | 1 | 74 | 27 | 2 | 6 | 0 | 0 | 1 | 0 | 1 | 0 | 0 | 0 | 112 |
| 16:00 | 0 | 96 | 23 | 1 | 3 | 0 | 0 | 0 | 1 | 0 | 0 | 0 | 0 | 124 |
| 17:00 | 1 | 88 | 25 | 0 | 1 | 0 | 0 | 0 | 0 | 0 | 0 | 0 | 0 | 115 |
| 18:00 | 1 | 80 | 28 | 0 | 1 | 0 | 0 | 0 | 0 | 0 | 0 | 0 | 0 | 110 |
| 19:00 | 1 | 61 | 17 | 0 | 2 | 0 | 0 | 0 | 0 | 0 | 0 | 0 | 0 | 81 |
| 20:00 | 0 | 50 | 15 | 0 | 2 | 0 | 0 | 0 | 0 | 0 | 0 | 0 | 0 | 67 |
| 21:00 | 0 | 31 | 12 | 0 | 1 | 0 | 0 | 0 | 0 | 0 | 0 | 0 | 0 | 44 |
| 22:00 | 0 | 23 | 5 | 0 | 1 | 0 | 0 | 0 | 2 | 0 | 0 | 0 | 0 | 31 |
| 23:00 | 0 | 7 | 2 | 0 | 0 | 0 | 0 | 0 | 0 | 0 | 0 | 0 | 0 | 9 |
| Totals | 9 | 1648 | 488 | 15 | 65 | 6 | | 9 | 14 | 1 | | | | 2255 |
| % of Totals | 0% | 73% | 22% | 1% | 3% | 0% | | 0% | 1% | 0% | | | | 100% |

| | | | | | | | | | | | | | | | |
|---------------------------------|---------------|-------|-------|-------|--------|------------------|---|-------|---------------|-------|---|-------------------------|--------|-------|--|
| AM Volumes | 3 | 881 | 255 | 10 | 33 | 4 | 0 | 4 | 7 | 0 | 0 | 0 | 0 | 1197 | |
| % AM | 0% | 39% | 11% | 0% | 1% | 0% | | 0% | 0% | | | | | 53% | |
| AM Peak Hour | 06:00 | 07:00 | 07:00 | 07:00 | 06:00 | 03:00 | | 02:00 | 01:00 | | | | | 07:00 | |
| Volume | 2 | 270 | 59 | 3 | 7 | 1 | | 1 | 1 | | | | | 337 | |
| PM Volumes | 6 | 767 | 233 | 5 | 32 | 2 | 0 | 5 | 7 | 1 | 0 | 0 | 0 | 1058 | |
| % PM | 0% | 34% | 10% | 0% | 1% | 0% | | 0% | 0% | 0% | | | | 47% | |
| PM Peak Hour | 13:00 | 14:00 | 12:00 | 15:00 | 12:00 | 12:00 | | 12:00 | 12:00 | 15:00 | | | | 14:00 | |
| Volume | 1 | 116 | 31 | 2 | 6 | 1 | | 2 | 3 | 1 | | | | 148 | |
| Directional Peak Periods | AM 7-9 | | | | | NOON 12-2 | | | PM 4-6 | | | Off Peak Volumes | | | |
| All Classes | Volume | ↔ | | % | Volume | ↔ | | % | Volume | ↔ | | % | Volume | ↔ | |
| | 553 | | | 25% | 217 | | | 10% | 239 | | | 11% | 1246 | | |

| Classification Definitions | | | | |
|-------------------------------|-------------------------------|----------------------------|-----------------------------|----------------------------|
| 1 Motorcycles | 4 Buses | 7 >=4-Axle Single Units | 10 >=6-Axle Single Trailers | 13 >=7-Axle Multi-Trailers |
| 2 Passenger Cars | 5 2-Axle, 6-Tire Single Units | 8 <=4-Axle Single Trailers | 11 <=5-Axle Multi-Trailers | |
| 3 2-Axle, 4-Tire Single Units | 6 3-Axle Single Units | 9 5-Axle Single Trailers | 12 6-Axle Multi-Trailers | |

CLASSIFICATION

Old Cornelia Hwy W/O Hyde Mill Rd

Day: Wednesday
Date: 3/30/2022

City: Lula
Project #: GA22_180057_002

Summary

| Time | # 1 | # 2 | # 3 | # 4 | # 5 | # 6 | # 7 | # 8 | # 9 | # 10 | # 11 | # 12 | # 13 | Total |
|--------------------|-----------|-------------|------------|-----------|------------|-----------|-----|-----------|-----------|-----------|------|------|------|-------------|
| 00:00 AM | 0 | 20 | 0 | 0 | 0 | 0 | 0 | 0 | 0 | 0 | 0 | 0 | 0 | 20 |
| 01:00 | 0 | 8 | 3 | 0 | 0 | 0 | 0 | 0 | 3 | 0 | 0 | 0 | 0 | 14 |
| 02:00 | 0 | 8 | 2 | 0 | 0 | 0 | 0 | 1 | 1 | 0 | 0 | 0 | 0 | 12 |
| 03:00 | 0 | 9 | 6 | 0 | 0 | 1 | 0 | 0 | 3 | 0 | 0 | 0 | 0 | 19 |
| 04:00 | 0 | 16 | 11 | 0 | 1 | 0 | 0 | 1 | 0 | 0 | 0 | 0 | 0 | 29 |
| 05:00 | 2 | 62 | 24 | 0 | 3 | 1 | 0 | 0 | 2 | 0 | 0 | 0 | 0 | 94 |
| 06:00 | 2 | 160 | 43 | 2 | 10 | 1 | 0 | 0 | 0 | 0 | 0 | 0 | 0 | 218 |
| 07:00 | 0 | 315 | 71 | 3 | 9 | 0 | 0 | 1 | 1 | 0 | 0 | 0 | 0 | 400 |
| 08:00 | 0 | 238 | 61 | 2 | 11 | 0 | 0 | 1 | 1 | 0 | 0 | 0 | 0 | 314 |
| 09:00 | 0 | 140 | 41 | 1 | 5 | 1 | 0 | 1 | 1 | 0 | 0 | 0 | 0 | 190 |
| 10:00 | 0 | 119 | 40 | 0 | 8 | 0 | 0 | 0 | 1 | 0 | 0 | 0 | 0 | 168 |
| 11:00 | 0 | 127 | 51 | 2 | 10 | 0 | 0 | 1 | 0 | 0 | 0 | 0 | 0 | 191 |
| 12:00 PM | 0 | 178 | 54 | 0 | 8 | 3 | 0 | 2 | 5 | 0 | 0 | 0 | 0 | 250 |
| 13:00 | 3 | 169 | 54 | 1 | 7 | 2 | 0 | 4 | 0 | 0 | 0 | 0 | 0 | 240 |
| 14:00 | 3 | 207 | 53 | 2 | 10 | 1 | 0 | 0 | 1 | 0 | 0 | 0 | 0 | 277 |
| 15:00 | 3 | 240 | 85 | 4 | 12 | 0 | 0 | 2 | 0 | 2 | 0 | 0 | 0 | 348 |
| 16:00 | 0 | 306 | 71 | 3 | 8 | 2 | 0 | 0 | 1 | 0 | 0 | 0 | 0 | 391 |
| 17:00 | 4 | 322 | 75 | 0 | 4 | 1 | 0 | 1 | 2 | 0 | 0 | 0 | 0 | 409 |
| 18:00 | 3 | 242 | 62 | 0 | 2 | 1 | 0 | 0 | 0 | 0 | 0 | 0 | 0 | 310 |
| 19:00 | 1 | 151 | 34 | 0 | 3 | 0 | 0 | 0 | 0 | 0 | 0 | 0 | 0 | 189 |
| 20:00 | 0 | 153 | 41 | 0 | 2 | 1 | 0 | 0 | 1 | 0 | 0 | 0 | 0 | 198 |
| 21:00 | 0 | 83 | 22 | 0 | 2 | 0 | 0 | 0 | 0 | 0 | 0 | 0 | 0 | 107 |
| 22:00 | 0 | 65 | 11 | 0 | 2 | 0 | 0 | 0 | 2 | 0 | 0 | 0 | 0 | 80 |
| 23:00 | 0 | 34 | 3 | 0 | 1 | 0 | 0 | 0 | 0 | 0 | 0 | 0 | 0 | 38 |
| Totals | 21 | 3372 | 918 | 20 | 118 | 15 | | 15 | 25 | 2 | | | | 4506 |
| % of Totals | 0% | 75% | 20% | 0% | 3% | 0% | | 0% | 1% | 0% | | | | 100% |

| | | | | | | | | | | | | | | |
|---------------------|-------|-------|-------|-------|-------|-------|---|-------|-------|-------|---|---|---|-------|
| AM Volumes | 4 | 1222 | 353 | 10 | 57 | 4 | 0 | 6 | 13 | 0 | 0 | 0 | 0 | 1669 |
| % AM | 0% | 27% | 8% | 0% | 1% | 0% | | 0% | 0% | | | | | 37% |
| AM Peak Hour | 05:00 | 07:00 | 07:00 | 07:00 | 08:00 | 03:00 | | 02:00 | 01:00 | | | | | 07:00 |
| Volume | 2 | 315 | 71 | 3 | 11 | 1 | | 1 | 3 | | | | | 400 |
| PM Volumes | 17 | 2150 | 565 | 10 | 61 | 11 | 0 | 9 | 12 | 2 | 0 | 0 | 0 | 2837 |
| % PM | 0% | 48% | 13% | 0% | 1% | 0% | | 0% | 0% | 0% | | | | 63% |
| PM Peak Hour | 17:00 | 17:00 | 15:00 | 15:00 | 15:00 | 12:00 | | 13:00 | 12:00 | 15:00 | | | | 17:00 |
| Volume | 4 | 322 | 85 | 4 | 12 | 3 | | 4 | 5 | 2 | | | | 409 |

| Directional Peak Periods All Classes | AM 7-9 | | NOON 12-2 | | PM 4-6 | | Off Peak Volumes | |
|---|--------|-----|-----------|-----|--------|-----|------------------|-----|
| | Volume | % | Volume | % | Volume | % | Volume | % |
| | 714 | 16% | 490 | 11% | 800 | 18% | 2502 | 56% |

| Classification Definitions | | | | |
|-------------------------------|-------------------------------|----------------------------|-----------------------------|----------------------------|
| 1 Motorcycles | 4 Buses | 7 >=4-Axle Single Units | 10 >=6-Axle Single Trailers | 13 >=7-Axle Multi-Trailers |
| 2 Passenger Cars | 5 2-Axle, 6-Tire Single Units | 8 <=4-Axle Single Trailers | 11 <=5-Axle Multi-Trailers | |
| 3 2-Axle, 4-Tire Single Units | 6 3-Axle Single Units | 9 5-Axle Single Trailers | 12 6-Axle Multi-Trailers | |

VOLUME

Old Cornelia Hwy W/O Hyde Mill Rd

Day: Wednesday
 Date: 3/30/2022

City: Lula
 Project #: GA22_180057_002

| DAILY TOTALS | | | | | | NB | SB | EB | WB | Total | | | | |
|----------------|----|----|-------|-------|-------|----------------|----|-------|-------|-------|-------|-----|-----|-----|
| | | | | | | 0 | 0 | 2,251 | 2,255 | 4,506 | | | | |
| AM Period | NB | SB | EB | WB | TOTAL | PM Period | NB | SB | EB | WB | TOTAL | | | |
| 00:00 | 0 | 0 | 4 | 0 | 4 | 12:00 | 0 | 0 | 35 | 23 | 58 | | | |
| 00:15 | 0 | 0 | 6 | 3 | 9 | 12:15 | 0 | 0 | 32 | 31 | 63 | | | |
| 00:30 | 0 | 0 | 2 | 2 | 4 | 12:30 | 0 | 0 | 32 | 32 | 64 | | | |
| 00:45 | 0 | 0 | 2 | 14 | 1 | 12:45 | 0 | 0 | 30 | 129 | 35 | 121 | 65 | 250 |
| 01:00 | 0 | 0 | 3 | 0 | 3 | 13:00 | 0 | 0 | 34 | 23 | 57 | | | |
| 01:15 | 0 | 0 | 3 | 2 | 5 | 13:15 | 0 | 0 | 27 | 27 | 54 | | | |
| 01:30 | 0 | 0 | 1 | 2 | 3 | 13:30 | 0 | 0 | 32 | 24 | 56 | | | |
| 01:45 | 0 | 0 | 2 | 9 | 1 | 13:45 | 0 | 0 | 51 | 144 | 22 | 96 | 73 | 240 |
| 02:00 | 0 | 0 | 1 | 0 | 1 | 14:00 | 0 | 0 | 21 | 34 | 55 | | | |
| 02:15 | 0 | 0 | 3 | 3 | 6 | 14:15 | 0 | 0 | 36 | 22 | 58 | | | |
| 02:30 | 0 | 0 | 0 | 0 | 0 | 14:30 | 0 | 0 | 38 | 45 | 83 | | | |
| 02:45 | 0 | 0 | 3 | 7 | 2 | 14:45 | 0 | 0 | 34 | 129 | 47 | 148 | 81 | 277 |
| 03:00 | 0 | 0 | 2 | 1 | 3 | 15:00 | 0 | 0 | 41 | 31 | 72 | | | |
| 03:15 | 0 | 0 | 3 | 4 | 7 | 15:15 | 0 | 0 | 53 | 28 | 81 | | | |
| 03:30 | 0 | 0 | 3 | 4 | 7 | 15:30 | 0 | 0 | 66 | 28 | 94 | | | |
| 03:45 | 0 | 0 | 1 | 9 | 1 | 15:45 | 0 | 0 | 76 | 236 | 25 | 112 | 101 | 348 |
| 04:00 | 0 | 0 | 2 | 3 | 5 | 16:00 | 0 | 0 | 66 | 26 | 92 | | | |
| 04:15 | 0 | 0 | 0 | 6 | 6 | 16:15 | 0 | 0 | 61 | 33 | 94 | | | |
| 04:30 | 0 | 0 | 1 | 6 | 7 | 16:30 | 0 | 0 | 62 | 34 | 96 | | | |
| 04:45 | 0 | 0 | 1 | 4 | 10 | 16:45 | 0 | 0 | 78 | 267 | 31 | 124 | 109 | 391 |
| 05:00 | 0 | 0 | 2 | 14 | 16 | 17:00 | 0 | 0 | 79 | 38 | 117 | | | |
| 05:15 | 0 | 0 | 0 | 23 | 23 | 17:15 | 0 | 0 | 91 | 31 | 122 | | | |
| 05:30 | 0 | 0 | 2 | 23 | 25 | 17:30 | 0 | 0 | 73 | 27 | 100 | | | |
| 05:45 | 0 | 0 | 3 | 7 | 27 | 17:45 | 0 | 0 | 51 | 294 | 19 | 115 | 70 | 409 |
| 06:00 | 0 | 0 | 8 | 37 | 45 | 18:00 | 0 | 0 | 60 | 35 | 95 | | | |
| 06:15 | 0 | 0 | 9 | 40 | 49 | 18:15 | 0 | 0 | 66 | 22 | 88 | | | |
| 06:30 | 0 | 0 | 4 | 57 | 61 | 18:30 | 0 | 0 | 48 | 29 | 77 | | | |
| 06:45 | 0 | 0 | 11 | 32 | 52 | 18:45 | 0 | 0 | 26 | 200 | 24 | 110 | 50 | 310 |
| 07:00 | 0 | 0 | 9 | 63 | 72 | 19:00 | 0 | 0 | 26 | 27 | 53 | | | |
| 07:15 | 0 | 0 | 16 | 75 | 91 | 19:15 | 0 | 0 | 27 | 23 | 50 | | | |
| 07:30 | 0 | 0 | 22 | 100 | 122 | 19:30 | 0 | 0 | 31 | 12 | 43 | | | |
| 07:45 | 0 | 0 | 16 | 63 | 99 | 19:45 | 0 | 0 | 24 | 108 | 19 | 81 | 43 | 189 |
| 08:00 | 0 | 0 | 38 | 94 | 132 | 20:00 | 0 | 0 | 37 | 20 | 57 | | | |
| 08:15 | 0 | 0 | 29 | 50 | 79 | 20:15 | 0 | 0 | 39 | 19 | 58 | | | |
| 08:30 | 0 | 0 | 16 | 37 | 53 | 20:30 | 0 | 0 | 26 | 16 | 42 | | | |
| 08:45 | 0 | 0 | 15 | 98 | 35 | 20:45 | 0 | 0 | 29 | 131 | 12 | 67 | 41 | 198 |
| 09:00 | 0 | 0 | 16 | 31 | 47 | 21:00 | 0 | 0 | 24 | 10 | 34 | | | |
| 09:15 | 0 | 0 | 17 | 34 | 51 | 21:15 | 0 | 0 | 19 | 7 | 26 | | | |
| 09:30 | 0 | 0 | 12 | 23 | 35 | 21:30 | 0 | 0 | 11 | 16 | 27 | | | |
| 09:45 | 0 | 0 | 16 | 61 | 41 | 21:45 | 0 | 0 | 9 | 63 | 11 | 44 | 20 | 107 |
| 10:00 | 0 | 0 | 13 | 30 | 43 | 22:00 | 0 | 0 | 19 | 6 | 25 | | | |
| 10:15 | 0 | 0 | 19 | 23 | 42 | 22:15 | 0 | 0 | 15 | 11 | 26 | | | |
| 10:30 | 0 | 0 | 19 | 21 | 40 | 22:30 | 0 | 0 | 4 | 9 | 13 | | | |
| 10:45 | 0 | 0 | 18 | 69 | 25 | 22:45 | 0 | 0 | 11 | 49 | 5 | 31 | 16 | 80 |
| 11:00 | 0 | 0 | 25 | 16 | 41 | 23:00 | 0 | 0 | 8 | 3 | 11 | | | |
| 11:15 | 0 | 0 | 28 | 21 | 49 | 23:15 | 0 | 0 | 8 | 4 | 12 | | | |
| 11:30 | 0 | 0 | 30 | 26 | 56 | 23:30 | 0 | 0 | 6 | 2 | 8 | | | |
| 11:45 | 0 | 0 | 16 | 99 | 29 | 23:45 | 0 | 0 | 7 | 29 | 0 | 9 | 7 | 38 |
| TOTALS | | | 472 | 1197 | 1669 | TOTALS | | | 1779 | 1058 | 2837 | | | |
| SPLIT % | | | 28.3% | 71.7% | 37.0% | SPLIT % | | | 62.7% | 37.3% | 63.0% | | | |

| DAILY TOTALS | | | | | | NB | SB | EB | WB | Total | |
|-----------------|-------|-------|-------|-------|-------|-----------------|-------|-------|-------|-------|-------|
| | | | | | | 0 | 0 | 2,251 | 2,255 | 4,506 | |
| AM Peak Hour | | | 11:45 | 07:15 | 07:15 | PM Peak Hour | | | 16:45 | 14:30 | 16:45 |
| AM Pk Volume | | | 115 | 368 | 460 | PM Pk Volume | | | 321 | 151 | 448 |
| Pk Hr Factor | | | 0.821 | 0.920 | 0.871 | Pk Hr Factor | | | 0.882 | 0.803 | 0.918 |
| 7 - 9 Volume | 0 | 0 | 161 | 553 | 714 | 4 - 6 Volume | 0 | 0 | 561 | 239 | 800 |
| 7 - 9 Peak Hour | | | 07:30 | 07:15 | 07:15 | 4 - 6 Peak Hour | | | 16:45 | 16:15 | 16:45 |
| 7 - 9 Pk Volume | 0 | 0 | 105 | 368 | 460 | 4 - 6 Pk Volume | 0 | 0 | 321 | 136 | 448 |
| Pk Hr Factor | 0.000 | 0.000 | 0.691 | 0.920 | 0.871 | Pk Hr Factor | 0.000 | 0.000 | 0.882 | 0.895 | 0.918 |

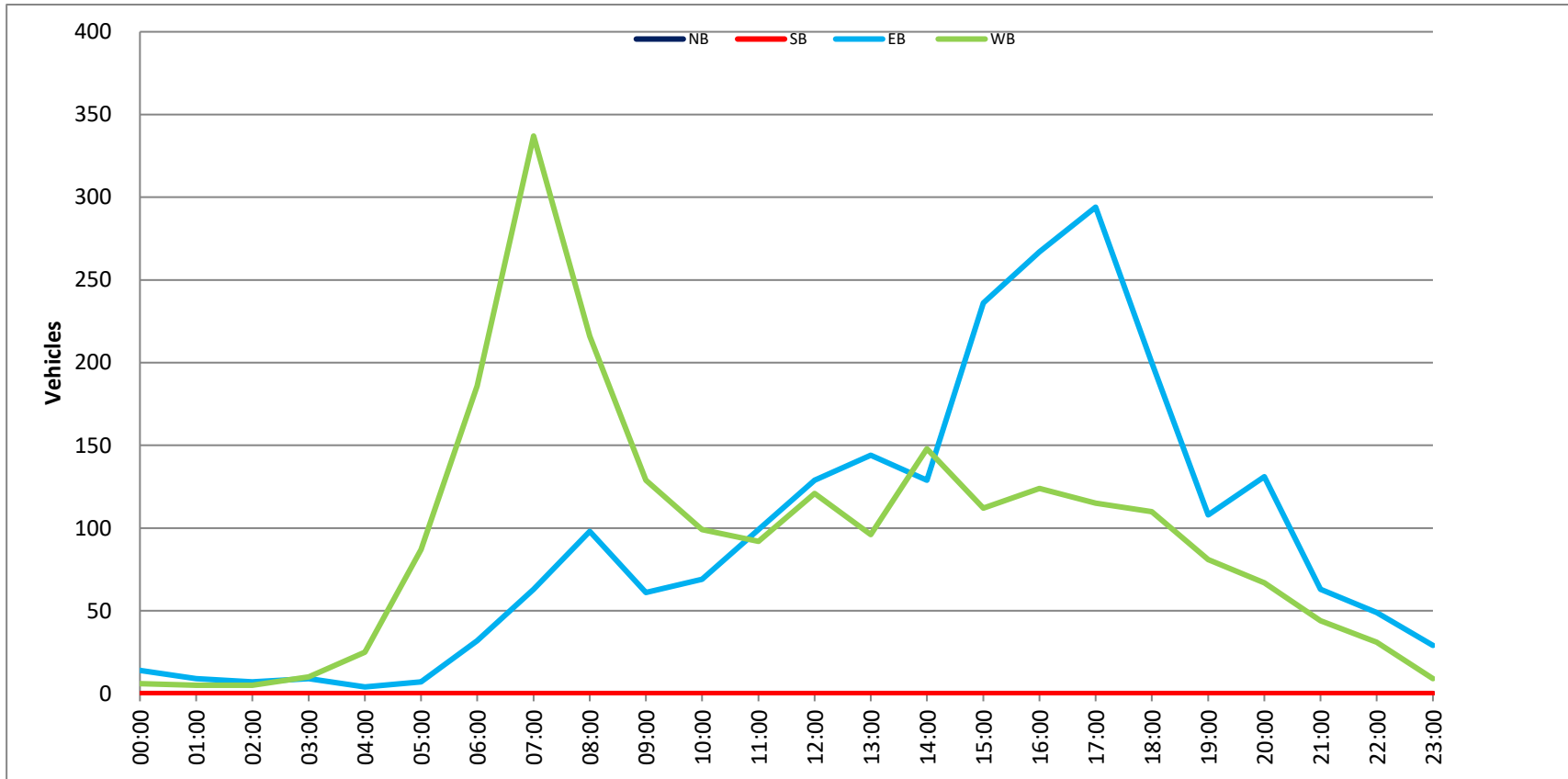

CLASSIFICATION

Cagle Mill Rd S/O Julian Baugh Rd

Day: Wednesday
Date: 4/12/2022

City: Lula
Project #: GA22_180057_003n

North Bound

Table with columns: Time, #1, #2, #3, #4, #5, #6, #7, #8, #9, #10, #11, #12, #13, Total. Rows include time intervals from 00:00 AM to 23:45 PM, with data values for each classification category.

Summary tables including: AM Volumes (% AM, Peak Hour), PM Volumes (% PM, Peak Hour), Directional Peak Periods, and All Classes (Volume, %). Includes classification definitions at the bottom.

Classification Definitions

- 1 Motorcycles 2 Passenger Cars 3 2-Axle, 4-Tire Single Units 4 Buses 5 2-Axle, 6-Tire Single Units 6 3-Axle Single Units 7 >=4-Axle Single Units 8 <=4-Axle Single Trailers 9 5-Axle Single Trailers 10 >>=6-Axle Single Trailers 11 <=5-Axle Multi-Trailers 12 6-Axle Multi-Trailers 13 >>=7-Axle Multi-Trailers

CLASSIFICATION

Cagle Mill Rd S/O Julian Baugh Rd

Day: Wednesday

Date: 3/30/2022

City: Lula

Project #: GA22_180057_003n

North Bound

| Time | # 1 | # 2 | # 3 | # 4 | # 5 | # 6 | # 7 | # 8 | # 9 | # 10 | # 11 | # 12 | # 13 | Total |
|--------------------|-----------|------------|------------|-----|-----------|-----|-----|-----|-----|------|------|------|------|-------------|
| 00:00 AM | 1 | 0 | 0 | 0 | 0 | 0 | 0 | 0 | 0 | 0 | 0 | 0 | 0 | 1 |
| 01:00 | 0 | 0 | 0 | 0 | 0 | 0 | 0 | 0 | 0 | 0 | 0 | 0 | 0 | 0 |
| 02:00 | 0 | 0 | 0 | 0 | 0 | 0 | 0 | 0 | 0 | 0 | 0 | 0 | 0 | 0 |
| 03:00 | 0 | 0 | 0 | 0 | 0 | 0 | 0 | 0 | 0 | 0 | 0 | 0 | 0 | 0 |
| 04:00 | 0 | 0 | 1 | 0 | 0 | 0 | 0 | 0 | 0 | 0 | 0 | 0 | 0 | 1 |
| 05:00 | 0 | 3 | 2 | 0 | 0 | 0 | 0 | 0 | 0 | 0 | 0 | 0 | 0 | 5 |
| 06:00 | 0 | 4 | 2 | 0 | 0 | 0 | 0 | 0 | 0 | 0 | 0 | 0 | 0 | 6 |
| 07:00 | 0 | 2 | 1 | 0 | 0 | 0 | 0 | 0 | 0 | 0 | 0 | 0 | 0 | 3 |
| 08:00 | 0 | 2 | 1 | 0 | 0 | 0 | 0 | 0 | 0 | 0 | 0 | 0 | 0 | 3 |
| 09:00 | 0 | 4 | 1 | 0 | 1 | 0 | 0 | 0 | 0 | 0 | 0 | 0 | 0 | 6 |
| 10:00 | 0 | 7 | 2 | 0 | 0 | 0 | 0 | 0 | 0 | 0 | 0 | 0 | 0 | 9 |
| 11:00 | 0 | 2 | 1 | 0 | 0 | 0 | 0 | 0 | 0 | 0 | 0 | 0 | 0 | 3 |
| 12:00 PM | 0 | 3 | 1 | 0 | 0 | 0 | 0 | 0 | 0 | 0 | 0 | 0 | 0 | 4 |
| 13:00 | 0 | 3 | 1 | 0 | 0 | 0 | 0 | 0 | 0 | 0 | 0 | 0 | 0 | 4 |
| 14:00 | 0 | 3 | 1 | 0 | 0 | 0 | 0 | 0 | 0 | 0 | 0 | 0 | 0 | 4 |
| 15:00 | 0 | 2 | 2 | 0 | 1 | 0 | 0 | 0 | 0 | 0 | 0 | 0 | 0 | 5 |
| 16:00 | 0 | 2 | 0 | 0 | 0 | 0 | 0 | 0 | 0 | 0 | 0 | 0 | 0 | 2 |
| 17:00 | 0 | 2 | 0 | 0 | 0 | 0 | 0 | 0 | 0 | 0 | 0 | 0 | 0 | 2 |
| 18:00 | 0 | 2 | 1 | 0 | 0 | 0 | 0 | 0 | 0 | 0 | 0 | 0 | 0 | 3 |
| 19:00 | 0 | 2 | 0 | 0 | 0 | 0 | 0 | 0 | 0 | 0 | 0 | 0 | 0 | 2 |
| 20:00 | 0 | 0 | 0 | 0 | 0 | 0 | 0 | 0 | 0 | 0 | 0 | 0 | 0 | 0 |
| 21:00 | 0 | 1 | 1 | 0 | 0 | 0 | 0 | 0 | 0 | 0 | 0 | 0 | 0 | 2 |
| 22:00 | 0 | 0 | 0 | 0 | 0 | 0 | 0 | 0 | 0 | 0 | 0 | 0 | 0 | 0 |
| 23:00 | 0 | 0 | 0 | 0 | 0 | 0 | 0 | 0 | 0 | 0 | 0 | 0 | 0 | 0 |
| Totals | 1 | 44 | 18 | | 2 | | | | | | | | | 65 |
| % of Totals | 2% | 68% | 28% | | 3% | | | | | | | | | 100% |

| | | | | | | | | | | | | | | | | |
|---------------------------------|----|---------------|-------|---|-------|------------------|---|---|-----|---------------|---|---|----|-------------------------|---|--|
| AM Volumes | 1 | 24 | 11 | 0 | 1 | 0 | 0 | 0 | 0 | 0 | 0 | 0 | 0 | 37 | | |
| % AM | 2% | 37% | 17% | | 2% | | | | | | | | | 57% | | |
| AM Peak Hour | | 10:00 | 05:00 | | 09:00 | | | | | | | | | 10:00 | | |
| Volume | 1 | 7 | 2 | | 1 | | | | | | | | | 9 | | |
| PM Volumes | 0 | 20 | 7 | 0 | 1 | 0 | 0 | 0 | 0 | 0 | 0 | 0 | 0 | 28 | | |
| % PM | | 31% | 11% | | 2% | | | | | | | | | 43% | | |
| PM Peak Hour | | 12:00 | 15:00 | | 15:00 | | | | | | | | | 15:00 | | |
| Volume | | 3 | 2 | | 1 | | | | | | | | | 5 | | |
| Directional Peak Periods | | AM 7-9 | | | | NOON 12-2 | | | | PM 4-6 | | | | Off Peak Volumes | | |
| All Classes | | Volume | ↔ | | % | Volume | ↔ | | % | Volume | ↔ | | % | Volume | ↔ | |
| | | 6 | | | 9% | 8 | | | 12% | 4 | | | 6% | 47 | | |

| Classification Definitions | | | | |
|-------------------------------|-------------------------------|----------------------------|-----------------------------|----------------------------|
| 1 Motorcycles | 4 Buses | 7 >=4-Axle Single Units | 10 >=6-Axle Single Trailers | 13 >=7-Axle Multi-Trailers |
| 2 Passenger Cars | 5 2-Axle, 6-Tire Single Units | 8 <=4-Axle Single Trailers | 11 <=5-Axle Multi-Trailers | |
| 3 2-Axle, 4-Tire Single Units | 6 3-Axle Single Units | 9 5-Axle Single Trailers | 12 6-Axle Multi-Trailers | |

CLASSIFICATION

Cagle Mill Rd S/O Julian Baugh Rd

Day: Wednesday

Date: 3/30/2022

City: Lula

Project #: GA22_180057_003s

South Bound

| Time | # 1 | # 2 | # 3 | # 4 | # 5 | # 6 | # 7 | # 8 | # 9 | # 10 | # 11 | # 12 | # 13 | Total |
|--------------------|-----------|------------|------------|-----|-----------|-----------|-----|-----|-----|------|------|------|------|-------------|
| 00:00 AM | 0 | 0 | 0 | 0 | 0 | 0 | 0 | 0 | 0 | 0 | 0 | 0 | 0 | 0 |
| 01:00 | 0 | 0 | 0 | 0 | 0 | 0 | 0 | 0 | 0 | 0 | 0 | 0 | 0 | 0 |
| 02:00 | 1 | 0 | 0 | 0 | 0 | 0 | 0 | 0 | 0 | 0 | 0 | 0 | 0 | 1 |
| 03:00 | 0 | 0 | 0 | 0 | 0 | 0 | 0 | 0 | 0 | 0 | 0 | 0 | 0 | 0 |
| 04:00 | 0 | 0 | 0 | 0 | 0 | 0 | 0 | 0 | 0 | 0 | 0 | 0 | 0 | 0 |
| 05:00 | 0 | 1 | 1 | 0 | 0 | 0 | 0 | 0 | 0 | 0 | 0 | 0 | 0 | 2 |
| 06:00 | 0 | 1 | 0 | 0 | 0 | 0 | 0 | 0 | 0 | 0 | 0 | 0 | 0 | 1 |
| 07:00 | 0 | 1 | 1 | 0 | 0 | 1 | 0 | 0 | 0 | 0 | 0 | 0 | 0 | 3 |
| 08:00 | 0 | 1 | 4 | 0 | 0 | 0 | 0 | 0 | 0 | 0 | 0 | 0 | 0 | 5 |
| 09:00 | 0 | 3 | 0 | 0 | 0 | 0 | 0 | 0 | 0 | 0 | 0 | 0 | 0 | 3 |
| 10:00 | 0 | 3 | 0 | 0 | 0 | 0 | 0 | 0 | 0 | 0 | 0 | 0 | 0 | 3 |
| 11:00 | 0 | 3 | 0 | 0 | 1 | 0 | 0 | 0 | 0 | 0 | 0 | 0 | 0 | 4 |
| 12:00 PM | 0 | 1 | 1 | 0 | 0 | 0 | 0 | 0 | 0 | 0 | 0 | 0 | 0 | 2 |
| 13:00 | 0 | 3 | 1 | 0 | 0 | 0 | 0 | 0 | 0 | 0 | 0 | 0 | 0 | 4 |
| 14:00 | 0 | 4 | 0 | 0 | 0 | 1 | 0 | 0 | 0 | 0 | 0 | 0 | 0 | 5 |
| 15:00 | 0 | 5 | 2 | 0 | 0 | 0 | 0 | 0 | 0 | 0 | 0 | 0 | 0 | 7 |
| 16:00 | 0 | 4 | 1 | 0 | 0 | 0 | 0 | 0 | 0 | 0 | 0 | 0 | 0 | 5 |
| 17:00 | 0 | 1 | 1 | 0 | 0 | 0 | 0 | 0 | 0 | 0 | 0 | 0 | 0 | 2 |
| 18:00 | 0 | 4 | 1 | 0 | 0 | 0 | 0 | 0 | 0 | 0 | 0 | 0 | 0 | 5 |
| 19:00 | 0 | 7 | 2 | 0 | 0 | 0 | 0 | 0 | 0 | 0 | 0 | 0 | 0 | 9 |
| 20:00 | 0 | 1 | 0 | 0 | 0 | 0 | 0 | 0 | 0 | 0 | 0 | 0 | 0 | 1 |
| 21:00 | 0 | 4 | 2 | 0 | 0 | 0 | 0 | 0 | 0 | 0 | 0 | 0 | 0 | 6 |
| 22:00 | 0 | 1 | 0 | 0 | 0 | 0 | 0 | 0 | 0 | 0 | 0 | 0 | 0 | 1 |
| 23:00 | 0 | 0 | 0 | 0 | 0 | 0 | 0 | 0 | 0 | 0 | 0 | 0 | 0 | 0 |
| Totals | 1 | 48 | 17 | | 1 | 2 | | | | | | | | 69 |
| % of Totals | 1% | 70% | 25% | | 1% | 3% | | | | | | | | 100% |

| | | | | | | | | | | | | | | | | |
|---------------------------------|-------|---------------|-------|---|-------|------------------|---|---|---------------|--------|---|-------------------------|-----|--------|-------|--|
| AM Volumes | 1 | 13 | 6 | 0 | 1 | 1 | 0 | 0 | 0 | 0 | 0 | 0 | 0 | 22 | | |
| % AM | 1% | 19% | 9% | | 1% | 1% | | | | | | | | 32% | | |
| AM Peak Hour | 02:00 | 09:00 | 08:00 | | 11:00 | 07:00 | | | | | | | | 08:00 | | |
| Volume | 1 | 3 | 4 | | 1 | 1 | | | | | | | | 5 | | |
| PM Volumes | 0 | 35 | 11 | 0 | 0 | 1 | 0 | 0 | 0 | 0 | 0 | 0 | 0 | 47 | | |
| % PM | | 51% | 16% | | | 1% | | | | | | | | 68% | | |
| PM Peak Hour | | 19:00 | 15:00 | | | 14:00 | | | | | | | | 19:00 | | |
| Volume | | 7 | 2 | | | 1 | | | | | | | | 9 | | |
| Directional Peak Periods | | AM 7-9 | | | | NOON 12-2 | | | PM 4-6 | | | Off Peak Volumes | | | | |
| All Classes | | Volume | | | % | Volume | | | % | Volume | | | % | Volume | | |
| | | 8 | ↔ | | 12% | 6 | ↔ | | 9% | 7 | ↔ | | 10% | 48 | ↔ 70% | |

| Classification Definitions | | | | |
|-------------------------------|-------------------------------|----------------------------|-----------------------------|----------------------------|
| 1 Motorcycles | 4 Buses | 7 >=4-Axle Single Units | 10 >=6-Axle Single Trailers | 13 >=7-Axle Multi-Trailers |
| 2 Passenger Cars | 5 2-Axle, 6-Tire Single Units | 8 <=4-Axle Single Trailers | 11 <=5-Axle Multi-Trailers | |
| 3 2-Axle, 4-Tire Single Units | 6 3-Axle Single Units | 9 5-Axle Single Trailers | 12 6-Axle Multi-Trailers | |

CLASSIFICATION

Cagle Mill Rd S/O Julian Baugh Rd

Day: Wednesday

Date: 3/30/2022

City: Lula

Project #: GA22_180057_003

Summary

| Time | # 1 | # 2 | # 3 | # 4 | # 5 | # 6 | # 7 | # 8 | # 9 | # 10 | # 11 | # 12 | # 13 | Total |
|--------------------|-----------|------------|------------|-----|-----------|-----------|-----|-----|-----|------|------|------|------|-------------|
| 00:00 AM | 1 | 0 | 0 | 0 | 0 | 0 | 0 | 0 | 0 | 0 | 0 | 0 | 0 | 1 |
| 01:00 | 0 | 0 | 0 | 0 | 0 | 0 | 0 | 0 | 0 | 0 | 0 | 0 | 0 | 0 |
| 02:00 | 1 | 0 | 0 | 0 | 0 | 0 | 0 | 0 | 0 | 0 | 0 | 0 | 0 | 1 |
| 03:00 | 0 | 0 | 0 | 0 | 0 | 0 | 0 | 0 | 0 | 0 | 0 | 0 | 0 | 0 |
| 04:00 | 0 | 0 | 1 | 0 | 0 | 0 | 0 | 0 | 0 | 0 | 0 | 0 | 0 | 1 |
| 05:00 | 0 | 4 | 3 | 0 | 0 | 0 | 0 | 0 | 0 | 0 | 0 | 0 | 0 | 7 |
| 06:00 | 0 | 5 | 2 | 0 | 0 | 0 | 0 | 0 | 0 | 0 | 0 | 0 | 0 | 7 |
| 07:00 | 0 | 3 | 2 | 0 | 0 | 1 | 0 | 0 | 0 | 0 | 0 | 0 | 0 | 6 |
| 08:00 | 0 | 3 | 5 | 0 | 0 | 0 | 0 | 0 | 0 | 0 | 0 | 0 | 0 | 8 |
| 09:00 | 0 | 7 | 1 | 0 | 1 | 0 | 0 | 0 | 0 | 0 | 0 | 0 | 0 | 9 |
| 10:00 | 0 | 10 | 2 | 0 | 0 | 0 | 0 | 0 | 0 | 0 | 0 | 0 | 0 | 12 |
| 11:00 | 0 | 5 | 1 | 0 | 1 | 0 | 0 | 0 | 0 | 0 | 0 | 0 | 0 | 7 |
| 12:00 PM | 0 | 4 | 2 | 0 | 0 | 0 | 0 | 0 | 0 | 0 | 0 | 0 | 0 | 6 |
| 13:00 | 0 | 6 | 2 | 0 | 0 | 0 | 0 | 0 | 0 | 0 | 0 | 0 | 0 | 8 |
| 14:00 | 0 | 7 | 1 | 0 | 0 | 1 | 0 | 0 | 0 | 0 | 0 | 0 | 0 | 9 |
| 15:00 | 0 | 7 | 4 | 0 | 1 | 0 | 0 | 0 | 0 | 0 | 0 | 0 | 0 | 12 |
| 16:00 | 0 | 6 | 1 | 0 | 0 | 0 | 0 | 0 | 0 | 0 | 0 | 0 | 0 | 7 |
| 17:00 | 0 | 3 | 1 | 0 | 0 | 0 | 0 | 0 | 0 | 0 | 0 | 0 | 0 | 4 |
| 18:00 | 0 | 6 | 2 | 0 | 0 | 0 | 0 | 0 | 0 | 0 | 0 | 0 | 0 | 8 |
| 19:00 | 0 | 9 | 2 | 0 | 0 | 0 | 0 | 0 | 0 | 0 | 0 | 0 | 0 | 11 |
| 20:00 | 0 | 1 | 0 | 0 | 0 | 0 | 0 | 0 | 0 | 0 | 0 | 0 | 0 | 1 |
| 21:00 | 0 | 5 | 3 | 0 | 0 | 0 | 0 | 0 | 0 | 0 | 0 | 0 | 0 | 8 |
| 22:00 | 0 | 1 | 0 | 0 | 0 | 0 | 0 | 0 | 0 | 0 | 0 | 0 | 0 | 1 |
| 23:00 | 0 | 0 | 0 | 0 | 0 | 0 | 0 | 0 | 0 | 0 | 0 | 0 | 0 | 0 |
| Totals | 2 | 92 | 35 | | 3 | 2 | | | | | | | | 134 |
| % of Totals | 1% | 69% | 26% | | 2% | 1% | | | | | | | | 100% |

| | | | | | | | | | | | | | | | | |
|---------------------------------|--------|-------|-------|---|---------------|-------|-----|------------------|--------|---|---------------|---|-------------------------|-------|-----|--|
| AM Volumes | 2 | 37 | 17 | 0 | 2 | 1 | 0 | 0 | 0 | 0 | 0 | 0 | 0 | 59 | | |
| % AM | 1% | 28% | 13% | | 1% | 1% | | | | | | | | 44% | | |
| AM Peak Hour | | 10:00 | 08:00 | | 09:00 | 07:00 | | | | | | | | 10:00 | | |
| Volume | 1 | 10 | 5 | | 1 | 1 | | | | | | | | 12 | | |
| PM Volumes | 0 | 55 | 18 | 0 | 1 | 1 | 0 | 0 | 0 | 0 | 0 | 0 | 0 | 75 | | |
| % PM | | 41% | 13% | | 1% | 1% | | | | | | | | 56% | | |
| PM Peak Hour | | 19:00 | 15:00 | | 15:00 | 14:00 | | | | | | | | 15:00 | | |
| Volume | | 9 | 4 | | 1 | 1 | | | | | | | | 12 | | |
| Directional Peak Periods | | | | | AM 7-9 | | | NOON 12-2 | | | PM 4-6 | | Off Peak Volumes | | | |
| All Classes | Volume | | % | | Volume | | % | | Volume | | % | | Volume | | % | |
| | 14 | | 10% | | 14 | | 10% | | 11 | | 8% | | 95 | | 71% | |

Classification Definitions

| | | | | |
|-------------------------------|-------------------------------|----------------------------|-----------------------------|----------------------------|
| 1 Motorcycles | 4 Buses | 7 >=4-Axle Single Units | 10 >=6-Axle Single Trailers | 13 >=7-Axle Multi-Trailers |
| 2 Passenger Cars | 5 2-Axle, 6-Tire Single Units | 8 <=4-Axle Single Trailers | 11 <=5-Axle Multi-Trailers | |
| 3 2-Axle, 4-Tire Single Units | 6 3-Axle Single Units | 9 5-Axle Single Trailers | 12 6-Axle Multi-Trailers | |

VOLUME

Cagle Mill Rd S/O Julian Baugh Rd

Day: Wednesday
 Date: 3/30/2022

City: Lula
 Project #: GA22_180057_003

| DAILY TOTALS | | | | | NB | SB | EB | WB | Total | | |
|----------------|-------|-------|----|----|-------|----------------|-------|-------|-------|----|-------|
| | | | | | 65 | 69 | 0 | 0 | 134 | | |
| AM Period | NB | SB | EB | WB | TOTAL | PM Period | NB | SB | EB | WB | TOTAL |
| 00:00 | 0 | 0 | 0 | 0 | | 12:00 | 0 | 0 | 0 | 0 | |
| 00:15 | 1 | 0 | 0 | 0 | 1 | 12:15 | 1 | 1 | 0 | 0 | 2 |
| 00:30 | 0 | 0 | 0 | 0 | | 12:30 | 3 | 1 | 0 | 0 | 4 |
| 00:45 | 0 | 1 | 0 | 0 | 1 | 12:45 | 0 | 4 | 0 | 2 | 6 |
| 01:00 | 0 | 0 | 0 | 0 | | 13:00 | 2 | 1 | 0 | 0 | 3 |
| 01:15 | 0 | 0 | 0 | 0 | | 13:15 | 0 | 1 | 0 | 0 | 1 |
| 01:30 | 0 | 0 | 0 | 0 | | 13:30 | 0 | 1 | 0 | 0 | 1 |
| 01:45 | 0 | 0 | 0 | 0 | | 13:45 | 2 | 4 | 1 | 4 | 8 |
| 02:00 | 0 | 1 | 0 | 0 | 1 | 14:00 | 1 | 1 | 0 | 0 | 2 |
| 02:15 | 0 | 0 | 0 | 0 | | 14:15 | 1 | 1 | 0 | 0 | 2 |
| 02:30 | 0 | 0 | 0 | 0 | | 14:30 | 1 | 0 | 0 | 0 | 1 |
| 02:45 | 0 | 0 | 1 | 0 | 1 | 14:45 | 1 | 4 | 3 | 5 | 9 |
| 03:00 | 0 | 0 | 0 | 0 | | 15:00 | 0 | 0 | 0 | 0 | |
| 03:15 | 0 | 0 | 0 | 0 | | 15:15 | 1 | 1 | 0 | 0 | 2 |
| 03:30 | 0 | 0 | 0 | 0 | | 15:30 | 2 | 1 | 0 | 0 | 3 |
| 03:45 | 0 | 0 | 0 | 0 | | 15:45 | 2 | 5 | 7 | 0 | 12 |
| 04:00 | 0 | 0 | 0 | 0 | | 16:00 | 0 | 2 | 0 | 0 | 2 |
| 04:15 | 0 | 0 | 0 | 0 | | 16:15 | 1 | 1 | 0 | 0 | 2 |
| 04:30 | 0 | 0 | 0 | 0 | | 16:30 | 1 | 0 | 0 | 0 | 1 |
| 04:45 | 1 | 1 | 0 | 0 | 1 | 16:45 | 0 | 2 | 2 | 5 | 7 |
| 05:00 | 1 | 1 | 0 | 0 | 2 | 17:00 | 2 | 0 | 0 | 0 | 2 |
| 05:15 | 0 | 0 | 0 | 0 | | 17:15 | 0 | 0 | 0 | 0 | |
| 05:30 | 2 | 0 | 0 | 0 | 2 | 17:30 | 0 | 1 | 0 | 0 | 1 |
| 05:45 | 2 | 5 | 1 | 2 | 3 | 17:45 | 0 | 2 | 1 | 2 | 4 |
| 06:00 | 1 | 0 | 0 | 0 | 1 | 18:00 | 2 | 0 | 0 | 0 | 2 |
| 06:15 | 4 | 0 | 0 | 0 | 4 | 18:15 | 0 | 2 | 0 | 0 | 2 |
| 06:30 | 1 | 0 | 0 | 0 | 1 | 18:30 | 0 | 2 | 0 | 0 | 2 |
| 06:45 | 0 | 6 | 1 | 1 | 1 | 18:45 | 1 | 3 | 1 | 5 | 8 |
| 07:00 | 1 | 0 | 0 | 0 | 1 | 19:00 | 1 | 6 | 0 | 0 | 7 |
| 07:15 | 1 | 1 | 0 | 0 | 2 | 19:15 | 0 | 1 | 0 | 0 | 1 |
| 07:30 | 0 | 0 | 0 | 0 | | 19:30 | 0 | 1 | 0 | 0 | 1 |
| 07:45 | 1 | 3 | 2 | 3 | 3 | 19:45 | 1 | 2 | 1 | 9 | 11 |
| 08:00 | 0 | 1 | 0 | 0 | 1 | 20:00 | 0 | 1 | 0 | 0 | 1 |
| 08:15 | 1 | 1 | 0 | 0 | 2 | 20:15 | 0 | 0 | 0 | 0 | |
| 08:30 | 2 | 1 | 0 | 0 | 3 | 20:30 | 0 | 0 | 0 | 0 | |
| 08:45 | 0 | 3 | 2 | 5 | 2 | 20:45 | 0 | 0 | 1 | 0 | 1 |
| 09:00 | 0 | 1 | 0 | 0 | 1 | 21:00 | 1 | 2 | 0 | 0 | 3 |
| 09:15 | 2 | 0 | 0 | 0 | 2 | 21:15 | 0 | 1 | 0 | 0 | 1 |
| 09:30 | 2 | 2 | 0 | 0 | 4 | 21:30 | 1 | 1 | 0 | 0 | 2 |
| 09:45 | 2 | 6 | 0 | 3 | 2 | 21:45 | 0 | 2 | 2 | 6 | 8 |
| 10:00 | 0 | 0 | 0 | 0 | | 22:00 | 0 | 0 | 0 | 0 | |
| 10:15 | 3 | 1 | 0 | 0 | 4 | 22:15 | 0 | 1 | 0 | 0 | 1 |
| 10:30 | 2 | 2 | 0 | 0 | 4 | 22:30 | 0 | 0 | 0 | 0 | |
| 10:45 | 4 | 9 | 0 | 3 | 4 | 22:45 | 0 | 0 | 1 | 0 | 1 |
| 11:00 | 0 | 1 | 0 | 0 | 1 | 23:00 | 0 | 0 | 0 | 0 | |
| 11:15 | 1 | 3 | 0 | 0 | 4 | 23:15 | 0 | 0 | 0 | 0 | |
| 11:30 | 0 | 0 | 0 | 0 | | 23:30 | 0 | 0 | 0 | 0 | |
| 11:45 | 2 | 3 | 0 | 4 | 2 | 23:45 | 0 | 0 | 0 | 0 | |
| TOTALS | 37 | 22 | | | 59 | TOTALS | 28 | 47 | | | 75 |
| SPLIT % | 62.7% | 37.3% | | | 44.0% | SPLIT % | 37.3% | 62.7% | | | 56.0% |

| DAILY TOTALS | | | | | NB | SB | EB | WB | Total |
|-----------------|-------|-------|-------|-------|-----------------|-------|-------|-------|-------|
| | | | | | 65 | 69 | 0 | 0 | 134 |
| AM Peak Hour | 05:30 | 10:30 | | 10:15 | PM Peak Hour | 12:15 | 18:15 | 15:15 | |
| AM Pk Volume | 9 | 6 | | 13 | PM Pk Volume | 6 | 11 | 14 | |
| Pk Hr Factor | 0.563 | 0.500 | | 0.813 | Pk Hr Factor | 0.500 | 0.458 | 0.500 | |
| 7 - 9 Volume | 6 | 8 | 0 | 14 | 4 - 6 Volume | 4 | 7 | 0 | 11 |
| 7 - 9 Peak Hour | 07:45 | 07:45 | | 07:45 | 4 - 6 Peak Hour | 16:15 | 16:00 | | 16:00 |
| 7 - 9 Pk Volume | 4 | 5 | 0 | 9 | 4 - 6 Pk Volume | 4 | 5 | 0 | 7 |
| Pk Hr Factor | 0.500 | 0.625 | 0.000 | 0.750 | Pk Hr Factor | 0.500 | 0.625 | 0.000 | 0.875 |

Appendix E: Historic Traffic Counts

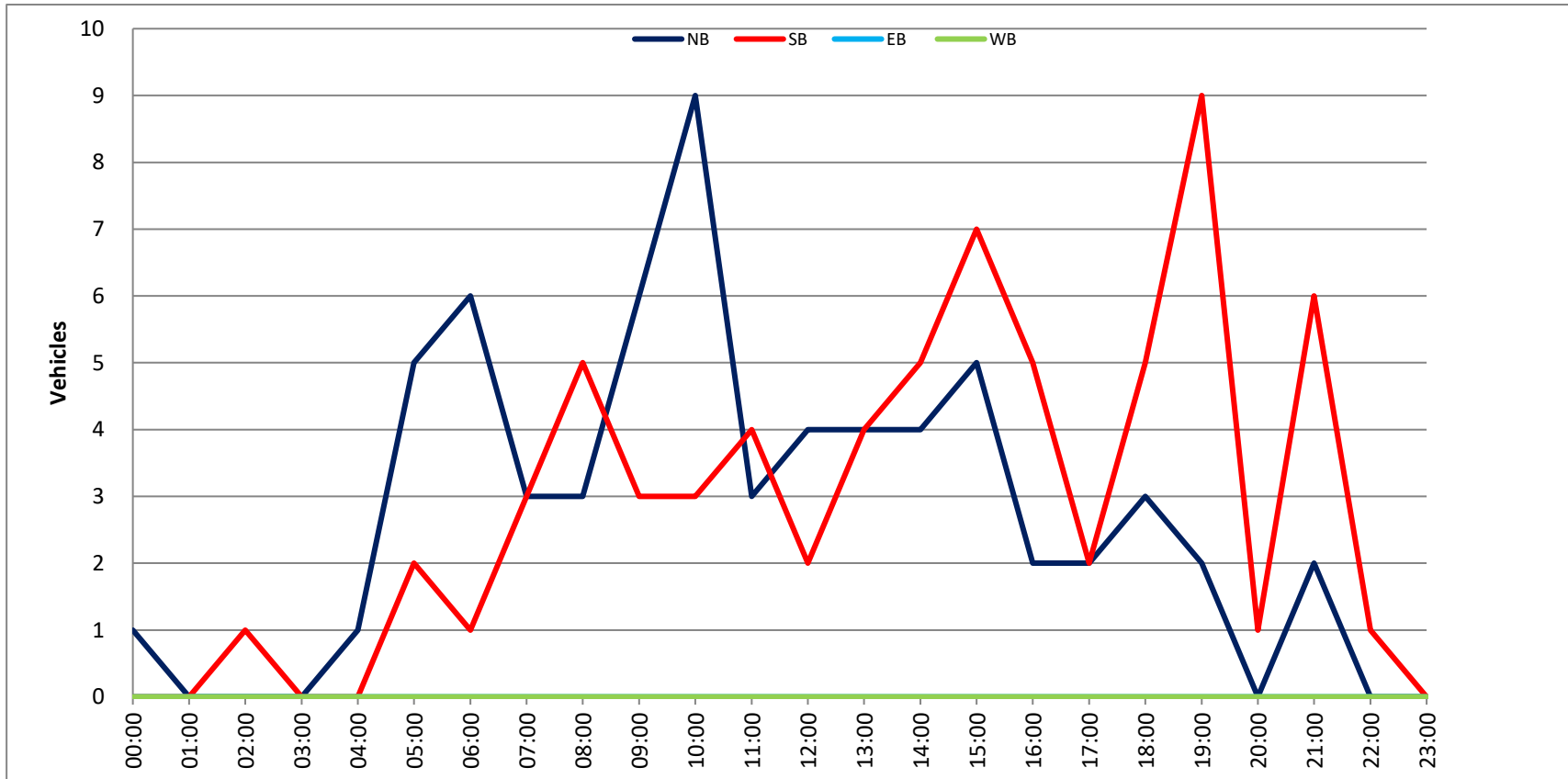



0000139_0225 - 139-0225
 Description: CRT 084900 R
 County: Hall
 Route number: 00145700
 LRS section: 1392145700
 Functional class: 5R - Major Collector (Rural)
 Coordinates: 34.3478044, -83.72471714

Site Data



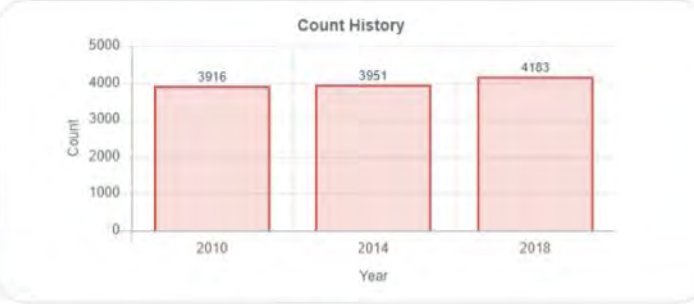
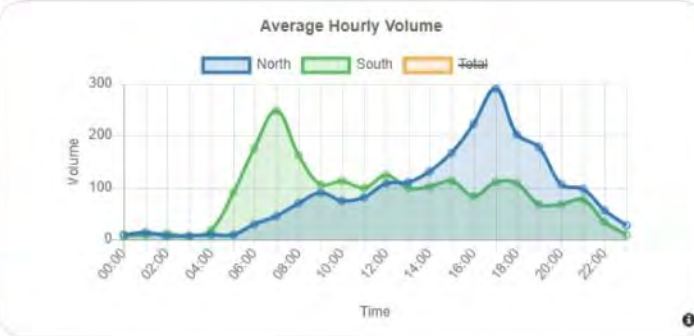

Count History

| Year | Month | Count type | Duration | Count |
|------|---------|------------|----------|-------|
| 2018 | July | Class | 48 hours | 4183 |
| 2014 | April | Volume | 48 hours | 3951 |
| 2010 | January | Volume | 48 hours | 3916 |

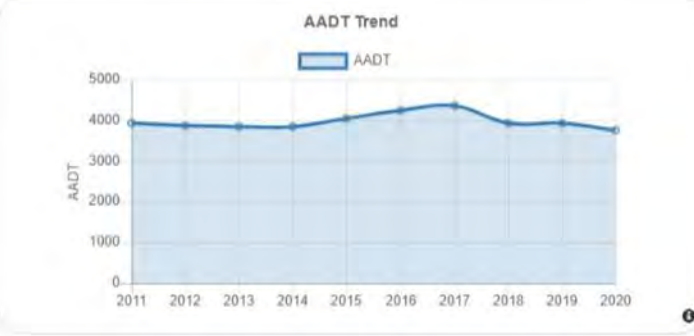

Annual Statistics

| Data Item | 2011 | 2012 | 2013 | 2014 | 2015 | 2016 | 2017 | 2018 | 2019 | 2020 |
|-----------------|------|------|------|-------|-----------|-----------|-----------|--------|-----------|-----------|
| Statistics type | - | - | - | - | Estimated | Estimated | Estimated | Actual | Estimated | Estimated |
| AADT | 3940 | 3880 | 3860 | 3850 | 4040 | 4250 | 4380 | 3930 | 3930 | 3770 |
| K-Factor | - | - | - | 0.104 | 0.104 | 0.104 | - | 0.104 | 0.104 | 0.104 |
| D-Factor | - | - | - | 0.500 | 0.500 | 0.500 | - | 0.720 | 0.720 | 0.720 |
| Future AADT | - | - | - | - | - | 4790 | 5520 | 4960 | 4950 | 4950 |



FHWA Vehicle Classification

| | | |
|--|--|--------|
| 1. Motorcycles 2 axes, 2 or 3 wheels. |  | 0.91% |
| 2. Passenger cars 2 axes. Can have 1- or 2-axle trailers. |  | 72.17% |
| 3. Pickups, panels, vans 2-axle, 4-tire single units. Can have 1- or 2-axle trailers. |  | 21.31% |
| 4. Buses 2- or 3-axle, full length. |  | 0.18% |
| 5. Single-unit trucks 2-axle, 6-tire, (dual rear tires), single-unit trucks. |  | 3.01% |
| 6. Single-unit trucks 3-axle, single-unit trucks. |  | 0.50% |
| 7. Single-unit trucks 4 or more axle, single-unit trucks. |  | 0% |
| 8. Single-trailer trucks 3- or 4-axle, single-trailer trucks. |  | 0.71% |
| 9. Single-trailer trucks 5-axle, single-trailer trucks. |  | 1.16% |
| 10. Single-trailer trucks 6 or more axle, single-trailer trucks. |  | 0.04% |
| 11. Multi-trailer trucks 5 or less axle, multi-trailer trucks. |  | 0% |
| 12. Multi-trailer trucks 6-axle, multi-trailer trucks. |  | 0% |
| 13. Multi-trailer trucks 7 or more axle, multi-trailer trucks. |  | 0.01% |



0000139_8201 - 139-8201
Description: CRY 092800 L
County: Hall
Route number: 00092400
LRS section: 1392092400
Functional class: 7R - Local (Rural)
Coordinates: 34.3604089054467, -83.7324372906166

Site Data



Count History

| Year | Month | Count type | Duration | Count |
|------|---------|------------|----------|-------|
| 2019 | July | Class | 48 hours | 482 |
| 2016 | July | Class | 72 hours | 295 |
| 2010 | October | Class | 48 hours | 361 |

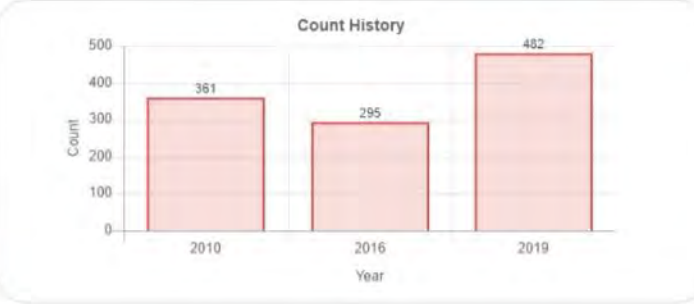

Annual Statistics

| Data Item | 2011 | 2012 | 2013 | 2014 | 2015 | 2016 | 2017 | 2018 | 2019 | 2020 |
|-----------------|------|------|------|------|-----------|--------|-----------|-----------|--------|-----------|
| Statistics type | - | - | - | - | Estimated | Actual | Estimated | Estimated | Actual | Estimated |
| AADT | 330 | 330 | 330 | 330 | 350 | 400 | 410 | 400 | 470 | 450 |
| K-Factor | - | - | - | - | - | 0.096 | - | - | 0.103 | 0.103 |
| D-Factor | - | - | - | - | - | 0.700 | - | - | 0.650 | 0.650 |
| Future AADT | - | - | - | - | - | 530 | 630 | 620 | 710 | 710 |



FHWA Vehicle Classification

- Motorcycles**
2 axes, 2 or 3 wheels.  0.41%
- Passenger cars**
2 axes. Can have 1- or 2-axle trailers.  66.63%
- Pickups, panels, vans**
2-axle, 4-tire single units. Can have 1- or 2-axle trailers.  27.36%
- Buses**
2- or 3-axle, full length.  0.83%
- Single-unit trucks**
2-axle, 6-tire, (dual rear tires), single-unit trucks.  3.73%
- Single-unit trucks**
3-axle, single-unit trucks.  0.10%
- Single-unit trucks**
4 or more axle, single-unit trucks.  0%
- Single-trailer trucks**
3- or 4-axle, single-trailer trucks.  0.52%
- Single-trailer trucks**
5-axle, single-trailer trucks.  0.41%
- Single-trailer trucks**
6 or more axle, single-trailer trucks.  0%
- Multi-trailer trucks**
5 or less axle, multi-trailer trucks.  0%
- Multi-trailer trucks**
6-axle, multi-trailer trucks.  0%
- Multi-trailer trucks**
7 or more axle, multi-trailer trucks.  0%



0000139_0215 - 139-0215
 Description: CRX 087600
 County: Hall
 Route number: 00041900
 LRS section: 1391041900
 Functional class: 3R - Principal Arterial - Other (Rural)
 Coordinates: 34.3939327144585, -83.6928845977857

Site Data



Count History

| Year | Month | Count type | Duration | Count |
|------|-----------|------------|----------|-------|
| 2019 | January | Class | 48 hours | 28906 |
| 2015 | June | Class | 48 hours | 31210 |
| 2013 | March | Class | 48 hours | 27163 |
| 2011 | September | Class | 48 hours | 27398 |
| 2010 | March | Volume | 48 hours | 28969 |

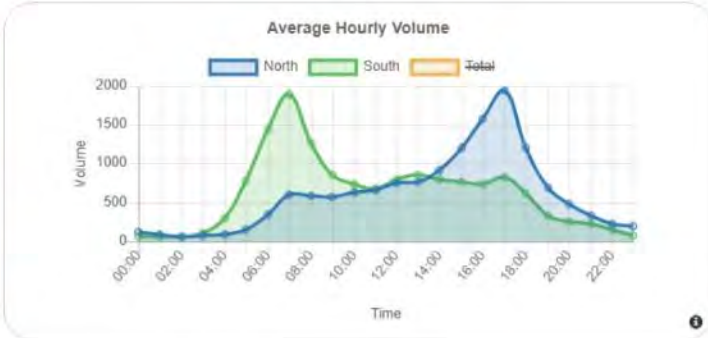

Annual Statistics

| Data Item | 2011 | 2012 | 2013 | 2014 | 2015 | 2016 | 2017 | 2018 | 2019 | 2020 |
|-----------------|-------|-------|-------|-------|--------|-----------|-----------|-----------|--------|-----------|
| Statistics type | - | - | - | - | Actual | Estimated | Estimated | Estimated | Actual | Estimated |
| AADT | 27200 | 26900 | 27300 | 30000 | 30000 | 31200 | 32200 | 32400 | 31700 | 30100 |
| K-Factor | - | - | 0.090 | 0.090 | 0.093 | 0.093 | - | - | 0.099 | 0.099 |
| D-Factor | - | - | 0.700 | 0.700 | 0.700 | 0.700 | - | - | 0.690 | 0.690 |
| Future AADT | - | - | - | - | - | 40100 | 43900 | 47400 | 46600 | 46600 |



| | | |
|---|--|--------|
| 1. Motorcycles 2 axes, 2 or 3 wheels. | | 0.07% |
| 2. Passenger cars 2 axes. Can have 1- or 2- axle trailers. | | 64.13% |
| 3. Pickups, panels, vans 2-axis, 4-tire single units. Can have 1- or 2-axle trailers. | | 24.66% |
| 4. Buses 2- or 3-axle, full length. | | 0.83% |
| 5. Single-unit trucks 2-axis, 6-tire, (dual rear tires), single-unit trucks. | | 4.83% |
| 6. Single-unit trucks 3-axle, single-unit trucks. | | 0.66% |
| 7. Single-unit trucks 4 or more axle, single-unit trucks. | | 0.01% |
| 8. Single-trailer trucks 3- or 4-axle, single-trailer trucks. | | 0.91% |
| 9. Single-trailer trucks 5-axle, single-trailer trucks. | | 3.73% |
| 10. Single-trailer trucks 6 or more axle, single-trailer trucks. | | 0.15% |
| 11. Multi-trailer trucks 5 or less axle, multi-trailer trucks. | | 0% |
| 12. Multi-trailer trucks 6-axle, multi-trailer trucks. | | 0% |
| 13. Multi-trailer trucks 7 or more axle, multi-trailer trucks. | | 0.02% |



0000139_0249 - 139-0249
Description: LULA
County: Hall
Route number: 00005200
LRS section: 1391005200
Functional class: 4R - Minor Arterial (Rural)
Coordinates: 34.38950853, -83.68435217

Site Data



Count History

| Year | Month | Count type | Duration | Count |
|------|----------|------------|----------|-------|
| 2020 | January | Volume | 48 hours | 2498 |
| 2018 | June | Class | 48 hours | 2468 |
| 2016 | July | Volume | 48 hours | 3136 |
| 2014 | April | Volume | 48 hours | 2524 |
| 2012 | February | Volume | 48 hours | 2446 |

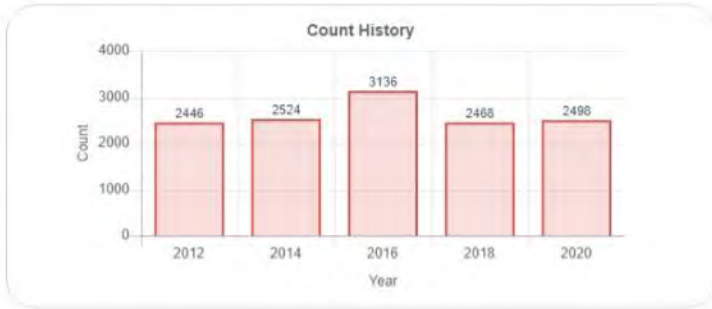

Annual Statistics

| Data Item | 2011 | 2012 | 2013 | 2014 | 2015 | 2016 | 2017 | 2018 | 2019 | 2020 |
|-----------------|------|------|------|-------|-----------|--------|-----------|--------|-----------|--------|
| Statistics type | - | - | - | - | Estimated | Actual | Estimated | Actual | Estimated | Actual |
| AADT | 2160 | 2200 | 2200 | 2430 | 2550 | 2700 | 2780 | 2380 | 2450 | 2170 |
| K-Factor | - | - | - | 0.098 | 0.098 | 0.101 | - | 0.102 | 0.102 | 0.096 |
| D-Factor | - | - | - | 0.500 | 0.500 | 0.500 | - | 0.520 | 0.520 | 0.520 |
| Future AADT | - | - | - | - | - | 2940 | 3550 | 3790 | 3640 | 3640 |





0000139_0248 - 139-0248
 County: Hall
 Route number: 00005200
 LRS section: 1391005200
 Functional class: 4R - Minor Arterial (Rural)
 Coordinates: 34.3756288365924, -83.6786885028939

Site Data



Count History

| Year | Month | Count type | Duration | Count |
|------|-----------|------------|----------|-------|
| 2021 | April | Class | 48 hours | 4050 |
| 2019 | January | Class | 48 hours | 3140 |
| 2015 | June | Class | 48 hours | 3348 |
| 2013 | March | Volume | 48 hours | 3621 |
| 2011 | September | Class | 48 hours | 3870 |
| 2010 | January | Class | 48 hours | 3574 |

Annual Statistics

| Data Item | 2011 | 2012 | 2013 | 2014 | 2015 | 2016 | 2017 | 2018 | 2019 | 2020 |
|-----------------|------|------|-------|-------|--------|-----------|-----------|-----------|--------|-----------|
| Statistics type | - | - | - | - | Actual | Estimated | Estimated | Estimated | Actual | Estimated |
| AADT | 3630 | 3610 | 3210 | 3210 | 3230 | 3360 | 3460 | 3480 | 3450 | 3270 |
| K-Factor | - | - | 0.110 | 0.110 | 0.115 | 0.115 | - | - | 0.109 | 0.109 |
| D-Factor | - | - | - | - | 0.600 | 0.600 | - | - | 0.540 | 0.540 |
| Future AADT | - | - | - | - | - | 4020 | 4360 | 4380 | 4350 | 4350 |

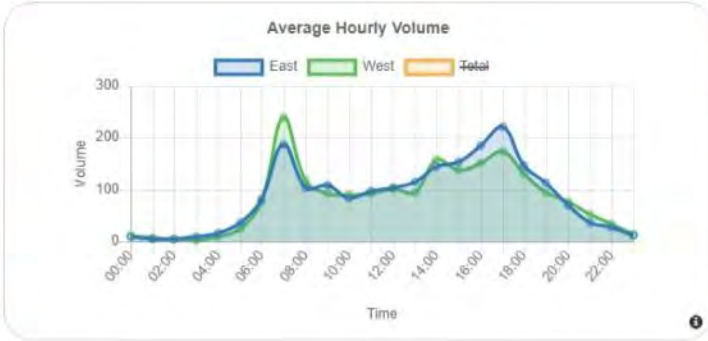

FHWA Vehicle Classification

| | | |
|--|--|--------|
| 1. Motorcycles 2 axes, 2 or 3 wheels. | | 0.69% |
| 2. Passenger cars 2 axes. Can have 1- or 2-axle trailers. | | 64.86% |
| 3. Pickups, panels, vans 2-axle, 4-tire single units. Can have 1- or 2-axle trailers. | | 25.68% |
| 4. Buses 2- or 3-axle, full length. | | 0.58% |
| 5. Single-unit trucks 2-axle, 6-tire, (dual rear tires), single-unit trucks. | | 3.79% |
| 6. Single-unit trucks 3-axle, single-unit trucks. | | 0.63% |
| 7. Single-unit trucks 4 or more axle, single-unit trucks. | | 0% |
| 8. Single-trailer trucks 3- or 4-axle, single-trailer trucks. | | 1.07% |
| 9. Single-trailer trucks 5-axle, single-trailer trucks. | | 2.67% |
| 10. Single-trailer trucks 6 or more axle, single-trailer trucks. | | 0.02% |
| 11. Multi-trailer trucks 5 or less axle, multi-trailer trucks. | | 0% |
| 12. Multi-trailer trucks 6-axle, multi-trailer trucks. | | 0% |
| 13. Multi-trailer trucks 7 or more axle, multi-trailer trucks. | | 0% |

0000139_0214 - 139-0214
 Description: CRX 129800
 County: Hall
 Route number: 00041900
 LRS section: 1391041900
 Functional class: 3R - Principal Arterial - Other (Rural)
 Coordinates: 34.3777272, -83.71739246

Site Data



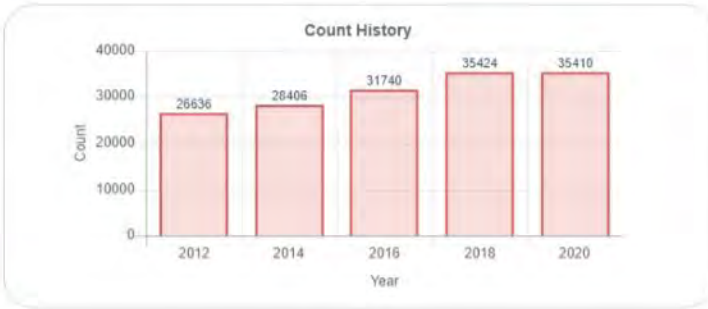
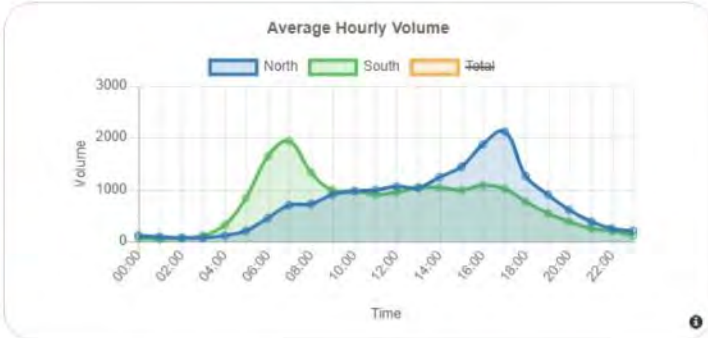

Count History

| Year | Month | Count type | Duration | Count |
|------|-----------|------------|----------|-------|
| 2020 | September | Class | 48 hours | 35410 |
| 2018 | July | Class | 48 hours | 35424 |
| 2016 | December | Class | 48 hours | 31740 |
| 2014 | April | Class | 48 hours | 28406 |
| 2012 | February | Class | 48 hours | 26636 |

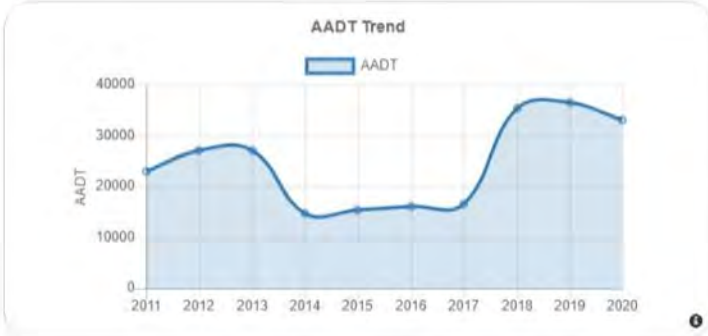

Annual Statistics

| Data Item | 2011 | 2012 | 2013 | 2014 | 2015 | 2016 | 2017 | 2018 | 2019 | 2020 |
|-----------------|-------|-------|-------|-------|-----------|-----------|-----------|--------|-----------|--------|
| Statistics type | - | - | - | - | Estimated | Estimated | Estimated | Actual | Estimated | Actual |
| AADT | 23000 | 27100 | 27100 | 14700 | 15400 | 16000 | 16500 | 35500 | 36500 | 33200 |
| K-Factor | - | - | - | 0.172 | 0.172 | 0.172 | - | 0.088 | 0.088 | 0.096 |
| D-Factor | - | - | - | 0.800 | 0.800 | 0.800 | - | 0.690 | 0.690 | 0.680 |
| Future AADT | - | - | - | - | - | 20700 | 20800 | 44700 | 46000 | 46000 |



FHWA Vehicle Classification

| | | |
|--|--|--------|
| 1. Motorcycles 2 axes, 2 or 3 wheels. |  | 0.25% |
| 2. Passenger cars 2 axes. Can have 1- or 2-axle trailers. |  | 48.74% |
| 3. Pickups, panels, vans 2-axle, 4-tire single units. Can have 1- or 2-axle trailers. |  | 35.64% |
| 4. Buses 2- or 3-axle, full length. |  | 1.67% |
| 5. Single-unit trucks 2-axle, 6-tire, (dual rear tires), single-unit trucks. |  | 10.23% |
| 6. Single-unit trucks 3-axle, single-unit trucks. |  | 0.61% |
| 7. Single-unit trucks 4 or more axle, single-unit trucks. |  | 0.01% |
| 8. Single-trailer trucks 3- or 4-axle, single-trailer trucks. |  | 0.61% |
| 9. Single-trailer trucks 5-axle, single-trailer trucks. |  | 2.14% |
| 10. Single-trailer trucks 6 or more axle, single-trailer trucks. |  | 0.08% |
| 11. Multi-trailer trucks 5 or less axle, multi-trailer trucks. |  | 0.01% |
| 12. Multi-trailer trucks 6-axle, multi-trailer trucks. |  | 0% |
| 13. Multi-trailer trucks 7 or more axle, multi-trailer trucks. |  | 0.01% |

Appendix F:
Existing Year and Future Year
Build and No-Build Volumes

AM

Existing COVID Adj

| INTID | NBL | NBT | NBR | SBU | SBL | SBT | SBR | EBL | EBT | EBR | WBL | WBT | WBR |
|-------|-----|-----|-----|-----|-----|------|-----|-----|-----|-----|-----|-----|-----|
| 1 | 57 | 864 | 0 | 1 | 0 | 2167 | 33 | 6 | 0 | 18 | 0 | 0 | 0 |
| 2 | 14 | 0 | 1 | 0 | 0 | 0 | 0 | 0 | 3 | 6 | 2 | 7 | 0 |
| 3 | 1 | 11 | 0 | 0 | 0 | 5 | 3 | 4 | 0 | 0 | 0 | 0 | 0 |
| 4 | 1 | 1 | 1 | 0 | 1 | 7 | 2 | 1 | 4 | 2 | 0 | 16 | 2 |
| 5 | 0 | 0 | 0 | 0 | 1 | 0 | 7 | 0 | 82 | 0 | 0 | 373 | 2 |
| 6 | 0 | 778 | 0 | 0 | 0 | 2178 | 2 | 2 | 0 | 1 | 22 | 2 | 1 |

No Build

2023

| INTID | NBL | NBT | NBR | SBU | SBL | SBT | SBR | EBL | EBT | EBR | WBL | WBT | WBR |
|-------|-----|-----|-----|-----|-----|------|-----|-----|-----|-----|-----|-----|-----|
| 1 | 59 | 892 | 0 | 1 | 0 | 2237 | 34 | 6 | 0 | 19 | 0 | 0 | 0 |
| 2 | 14 | 0 | 1 | 0 | 0 | 0 | 0 | 0 | 3 | 6 | 2 | 7 | 0 |
| 3 | 1 | 11 | 0 | 0 | 0 | 5 | 3 | 4 | 0 | 0 | 0 | 0 | 0 |
| 4 | 1 | 1 | 1 | 0 | 1 | 7 | 2 | 1 | 4 | 2 | 0 | 17 | 2 |
| 5 | 0 | 0 | 0 | 0 | 1 | 0 | 7 | 0 | 85 | 0 | 0 | 385 | 2 |
| 6 | 0 | 803 | 0 | 0 | 0 | 2249 | 2 | 2 | 0 | 1 | 23 | 2 | 1 |

No Build

2028

| INTID | NBL | NBT | NBR | SBU | SBL | SBT | SBR | EBL | EBT | EBR | WBL | WBT | WBR |
|-------|-----|------|-----|-----|-----|------|-----|-----|-----|-----|-----|-----|-----|
| 1 | 69 | 1047 | 0 | 1 | 0 | 2625 | 40 | 7 | 0 | 22 | 0 | 0 | 0 |
| 2 | 16 | 0 | 1 | 0 | 0 | 0 | 0 | 0 | 4 | 7 | 2 | 8 | 0 |
| 3 | 1 | 13 | 0 | 0 | 0 | 6 | 4 | 5 | 0 | 0 | 0 | 0 | 0 |
| 4 | 1 | 1 | 1 | 0 | 1 | 8 | 2 | 1 | 5 | 2 | 0 | 20 | 2 |
| 5 | 0 | 0 | 0 | 0 | 1 | 0 | 8 | 0 | 100 | 0 | 0 | 452 | 2 |
| 6 | 0 | 942 | 0 | 0 | 0 | 2639 | 2 | 2 | 0 | 1 | 27 | 2 | 1 |

Build

2023

| INTID | NBL | NBT | NBR | SBU | SBL | SBT | SBR | EBL | EBT | EBR | WBL | WBT | WBR |
|-------|-----|-----|-----|-----|-----|------|-----|-----|-----|-----|-----|-----|-----|
| 1 | 59 | 892 | 35 | 1 | 19 | 2237 | 34 | 6 | 0 | 19 | 105 | 0 | 55 |
| 2 | 14 | 0 | 1 | 0 | 0 | 0 | 0 | 0 | 3 | 6 | 2 | 7 | 0 |
| 3 | 2 | 11 | 0 | 0 | 0 | 5 | 5 | 10 | 0 | 0 | 0 | 0 | 0 |
| 4 | 1 | 2 | 1 | 0 | 2 | 15 | 4 | 2 | 4 | 2 | 0 | 17 | 4 |
| 5 | 0 | 0 | 0 | 0 | 2 | 0 | 14 | 0 | 85 | 0 | 0 | 385 | 3 |
| 6 | 0 | 858 | 0 | 0 | 0 | 2268 | 2 | 2 | 0 | 1 | 23 | 2 | 1 |
| 7 | 4 | 0 | 0 | 0 | 0 | 0 | 2 | 6 | 0 | 12 | 0 | 0 | 0 |
| 8 | 0 | 0 | 0 | 0 | 1 | 0 | 0 | 0 | 8 | 0 | 0 | 22 | 1 |

Build

2028

| INTID | NBL | NBT | NBR | SBU | SBL | SBT | SBR | EBL | EBT | EBR | WBL | WBT | WBR |
|-------|-----|------|-----|-----|-----|------|-----|-----|-----|-----|-----|-----|-----|
| 1 | 69 | 1047 | 35 | 1 | 19 | 2625 | 40 | 7 | 0 | 22 | 105 | 0 | 55 |
| 2 | 16 | 0 | 1 | 0 | 0 | 0 | 0 | 0 | 4 | 7 | 2 | 8 | 0 |
| 3 | 2 | 13 | 0 | 0 | 0 | 6 | 6 | 11 | 0 | 0 | 0 | 0 | 0 |
| 4 | 1 | 2 | 1 | 0 | 2 | 16 | 4 | 2 | 5 | 2 | 0 | 20 | 4 |
| 5 | 0 | 0 | 0 | 0 | 2 | 0 | 15 | 0 | 100 | 0 | 0 | 452 | 3 |
| 6 | 0 | 997 | 0 | 0 | 0 | 2658 | 2 | 2 | 0 | 1 | 27 | 2 | 1 |
| 7 | 4 | 0 | 0 | 0 | 0 | 0 | 2 | 6 | 0 | 12 | 0 | 0 | 0 |
| 8 | 0 | 0 | 0 | 0 | 1 | 0 | 0 | 0 | 9 | 0 | 0 | 25 | 1 |

PM

Existing COVID Adj

| INTID | NBL | NBT | NBR | SBU | SBL | SBT | SBR | EBL | EBT | EBR | WBL | WBT | WBR |
|-------|-----|------|-----|-----|-----|------|-----|-----|-----|-----|-----|-----|-----|
| 1 | 6 | 2475 | 0 | 2 | 0 | 1035 | 8 | 19 | 0 | 25 | 0 | 0 | 0 |
| 2 | 11 | 0 | 5 | 0 | 0 | 0 | 0 | 0 | 16 | 15 | 2 | 6 | 0 |
| 3 | 1 | 11 | 0 | 0 | 0 | 22 | 2 | 2 | 0 | 0 | 0 | 0 | 0 |
| 4 | 8 | 2 | 7 | 0 | 1 | 2 | 1 | 4 | 15 | 5 | 7 | 8 | 0 |
| 5 | 0 | 0 | 0 | 0 | 6 | 0 | 3 | 11 | 316 | 0 | 0 | 130 | 7 |
| 6 | 2 | 2463 | 25 | 0 | 1 | 1036 | 4 | 6 | 1 | 4 | 13 | 0 | 4 |

No Build

2023

| INTID | NBL | NBT | NBR | SBU | SBL | SBT | SBR | EBL | EBT | EBR | WBL | WBT | WBR |
|-------|-----|------|-----|-----|-----|------|-----|-----|-----|-----|-----|-----|-----|
| 1 | 6 | 2555 | 0 | 2 | 0 | 1069 | 8 | 20 | 0 | 26 | 0 | 0 | 0 |
| 2 | 11 | 0 | 5 | 0 | 0 | 0 | 0 | 0 | 17 | 15 | 2 | 6 | 0 |
| 3 | 1 | 11 | 0 | 0 | 0 | 23 | 2 | 2 | 0 | 0 | 0 | 0 | 0 |
| 4 | 8 | 2 | 7 | 0 | 1 | 2 | 1 | 4 | 15 | 5 | 7 | 8 | 0 |
| 5 | 0 | 0 | 0 | 0 | 6 | 0 | 3 | 11 | 326 | 0 | 0 | 134 | 7 |
| 6 | 2 | 2543 | 26 | 0 | 1 | 1070 | 4 | 6 | 1 | 4 | 13 | 0 | 4 |

No Build

2028

| INTID | NBL | NBT | NBR | SBU | SBL | SBT | SBR | EBL | EBT | EBR | WBL | WBT | WBR |
|-------|-----|------|-----|-----|-----|------|-----|-----|-----|-----|-----|-----|-----|
| 1 | 7 | 2998 | 0 | 2 | 0 | 1254 | 9 | 23 | 0 | 31 | 0 | 0 | 0 |
| 2 | 13 | 0 | 6 | 0 | 0 | 0 | 0 | 0 | 20 | 18 | 2 | 7 | 0 |
| 3 | 1 | 13 | 0 | 0 | 0 | 27 | 2 | 2 | 0 | 0 | 0 | 0 | 0 |
| 4 | 9 | 2 | 8 | 0 | 1 | 2 | 1 | 5 | 18 | 6 | 8 | 9 | 0 |
| 5 | 0 | 0 | 0 | 0 | 7 | 0 | 4 | 13 | 383 | 0 | 0 | 157 | 8 |
| 6 | 2 | 2984 | 31 | 0 | 1 | 1256 | 5 | 7 | 1 | 5 | 15 | 0 | 5 |

Build

2023

| INTID | NBL | NBT | NBR | SBU | SBL | SBT | SBR | EBL | EBT | EBR | WBL | WBT | WBR |
|-------|-----|------|-----|-----|-----|------|-----|-----|-----|-----|-----|-----|-----|
| 1 | 6 | 2555 | 110 | 2 | 68 | 1069 | 8 | 20 | 0 | 26 | 65 | 0 | 40 |
| 2 | 11 | 0 | 5 | 0 | 0 | 0 | 0 | 0 | 17 | 15 | 2 | 6 | 0 |
| 3 | 9 | 11 | 0 | 0 | 0 | 23 | 7 | 7 | 0 | 0 | 0 | 0 | 0 |
| 4 | 8 | 6 | 7 | 0 | 3 | 6 | 3 | 12 | 15 | 5 | 7 | 8 | 0 |
| 5 | 0 | 0 | 0 | 0 | 9 | 0 | 4 | 16 | 326 | 0 | 0 | 134 | 10 |
| 6 | 2 | 2583 | 26 | 0 | 1 | 1139 | 4 | 6 | 1 | 4 | 13 | 0 | 4 |
| 7 | 12 | 0 | 0 | 0 | 0 | 0 | 8 | 5 | 0 | 7 | 0 | 0 | 0 |
| 8 | 0 | 0 | 0 | 0 | 1 | 0 | 0 | 0 | 33 | 0 | 0 | 19 | 2 |

Build

2028

| INTID | NBL | NBT | NBR | SBU | SBL | SBT | SBR | EBL | EBT | EBR | WBL | WBT | WBR |
|-------|-----|------|-----|-----|-----|------|-----|-----|-----|-----|-----|-----|-----|
| 1 | 7 | 2998 | 110 | 2 | 68 | 1254 | 9 | 23 | 0 | 31 | 65 | 0 | 40 |
| 2 | 13 | 0 | 6 | 0 | 0 | 0 | 0 | 0 | 20 | 18 | 2 | 7 | 0 |
| 3 | 9 | 13 | 0 | 0 | 0 | 27 | 7 | 7 | 0 | 0 | 0 | 0 | 0 |
| 4 | 9 | 6 | 8 | 0 | 3 | 6 | 3 | 13 | 18 | 6 | 8 | 9 | 0 |
| 5 | 0 | 0 | 0 | 0 | 10 | 0 | 5 | 18 | 383 | 0 | 0 | 157 | 11 |
| 6 | 2 | 3024 | 31 | 0 | 1 | 1325 | 5 | 7 | 1 | 5 | 15 | 0 | 5 |
| 7 | 12 | 0 | 0 | 0 | 0 | 0 | 8 | 5 | 0 | 7 | 0 | 0 | 0 |
| 8 | 0 | 0 | 0 | 0 | 0 | 1 | 0 | 0 | 38 | 0 | 0 | 21 | 0 |

Appendix G: Truck Percentage Calculation Chart

| Old Cornelia Hwy W/O Hyde Mill Rd | | Truck Percentage Calculation | | | | | | |
|-----------------------------------|------------------------|------------------------------|-------------------------|-------------------------------|--|---------------------------------------|--|-----------------|
| | | Total | Class 1: Motorcycles | Class 2: Passenger Cars | Class 3: Pickups, Panels, Trucks | Classes 4-7: Single Unit Trucks | Classes 8-15: Combination Trucks | Total Trucks |
| | 24 hr T | | | | | | | |
| | Volume | 4506 | 21 | 3372 | 918 | 153 | 42 | |
| | Percentage | | 0% | 100% | 0% | 0% | 0% | 0.0% |
| | 7:15 AM-8:15 AM | | | | | | | |
| | Volume | 15430 | 354 | 87 | 5 | 12 | 2 | |
| | Percentage | | 0% | 0% | 0% | 0% | 0% | 0.0% |
| | 4:45 PM-5:45 PM | | | | | | | |
| | Volume | 448 | 2 | 355 | 80 | 9 | 2 | |
| | Percentage | | 0% | 100% | 0% | 0% | 0% | 0.0% |

| US 23/SR 365/Cornelia Hwy S/O Cagle Rd | | Truck Percentage Calculation | | | | | | |
|--|------------------------|------------------------------|-------------------------|-------------------------------|--|---------------------------------------|--|-----------------|
| | | Total | Class 1: Motorcycles | Class 2: Passenger Cars | Class 3: Pickups, Panels, Trucks | Classes 4-7: Single Unit Trucks | Classes 8-15: Combination Trucks | Total Trucks |
| | 24 hr T | | | | | | | |
| | Volume | 38014 | 42 | 27453 | 7547 | 1190 | 1782 | |
| | Percentage | | 0% | 100% | 0% | 0% | 0% | 0.0% |
| | 7:15 AM-8:15 AM | | | | | | | |
| | Volume | 2915 | 0 | 2087 | 672 | 81 | 75 | |
| | Percentage | | 0% | 100% | 0% | 0% | 0% | 0.0% |
| | 4:45 PM-5:45 PM | | | | | | | |
| | Volume | 3416 | 0 | 2504 | 742 | 75 | 95 | |
| | Percentage | | 0% | 100% | 0% | 0% | 0% | 0.0% |

| Cagle Mill Rd S/O Julian Baugh Rd | | Truck Percentage Calculation | | | | | | |
|-----------------------------------|--------------------------|------------------------------|-------------------------|-------------------------------|--|---------------------------------------|--|-----------------|
| | | Total | Class 1: Motorcycles | Class 2: Passenger Cars | Class 3: Pickups, Panels, Trucks | Classes 4-7: Single Unit Trucks | Classes 8-15: Combination Trucks | Total Trucks |
| | 24 hr T | | | | | | | |
| | Volume | 134 | 2 | 92 | 35 | 5 | 0 | |
| | Percentage | | 0% | 100% | 0% | 0% | 0% | 0.0% |
| | 10:15 AM-11:15 AM | | | | | | | |
| | Volume | 13 | 0 | 10 | 2 | 1 | 0 | |
| | Percentage | | 0% | 100% | 0% | 0% | 0% | 0.0% |
| | 3:15 PM-4:15 PM | | | | | | | |
| | Volume | 14 | 0 | 8 | 5 | 1 | 0 | |
| | Percentage | | 0% | 100% | 0% | 0% | 0% | 0.0% |

| Roadway | Truck Percentages | | | | | | | | |
|--|-------------------|--------------|-------------|-----------------|--------------|-------------|-----------------|--------------|-------------|
| | 24 hr T | | | 7:15 AM-8:15 AM | | | 4:45 PM-5:45 PM | | |
| | Light Trucks | Heavy Trucks | Total | Light Trucks | Heavy Trucks | Total | Light Trucks | Heavy Trucks | Total |
| US 23/SR 365/Cornelia Hwy S/O Cagle Rd | 0.0% | 0.0% | 0.0% | 0.0% | 0.0% | 0.0% | 0.0% | 0.0% | 0.0% |
| Old Cornelia Hwy W/O Hyde Mill Rd | 0.0% | 0.0% | 0.0% | 0.0% | 0.0% | 0.0% | 0.0% | 0.0% | 0.0% |
| Cagle Mill Rd S/O Julian Baugh Rd | 0.0% | 0.0% | 0.0% | 0.0% | 0.0% | 0.0% | 0.0% | 0.0% | 0.0% |

Appendix H: COVID-19 Factor Calculation

| TC Station | Location | Year of Most Recent GDOT Count | GDOT Historical ADT | Growth Rate | Theoretical 2022 ADT | Collected 2022 ADT | COVID-19 Factor |
|-------------------------|--|--------------------------------|---------------------|-------------|----------------------|--------------------|-----------------|
| 139-0214 | US 23/SR 365/Cornelia Hwy S/O Cagle Rd | 2018 | 35,216 | 3.25% | 40,022 | 38,014 | 1.05 |
| 139-8204 | Cagle Mill Rd S/O Cagle Rd | 2019 | 38 | 3.25% | 42 | 134 | 0.31 |
| 139-0225 | Old Cornelia Hwy S/O Country Lane | 2018 | 4,260 | 3.25% | 4,841 | 4,506 | 1.07 |
| Weighted Average | | | | | | | 1.05 |



Multi-Day Volume Report 139-8204 Wednesday, July 24, 2019

Multi-Day Volume Report 139-8204 Wednesday, July 24, 2019

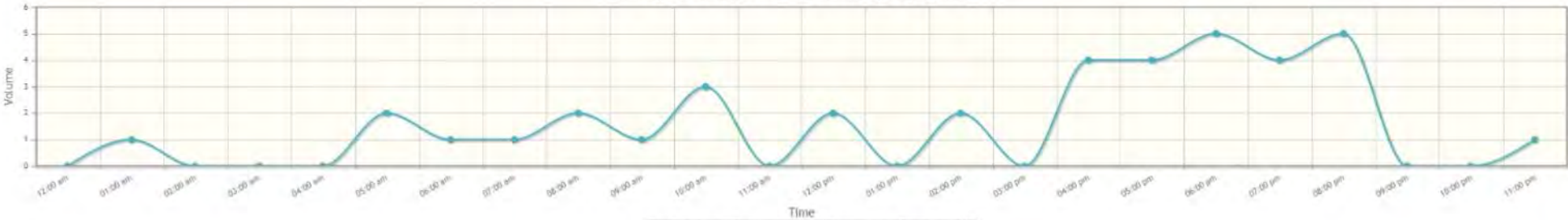

Toggle All
 Wed Jul 24
 Average Weekday
 Average 7 Day

Switch chart type | Open in new window | Export as image | Hide graph

Site Name: 139-8204 Site ID: 0000139_8204 Description: CR 092800 BEG AT

All Lanes ▾ Time Period: 1 hour ▾ Class: Any ▾ Exclude data: None ▾

| | Wed Jul 24 | Average Weekday | Average 7 Day | Total Count |
|-------------|------------|-----------------|---------------|-------------|
| 12:00 am | 0 | - | - | 0 |
| 01:00 am | 1 | - | - | 1 |
| 02:00 am | 0 | - | - | 0 |
| 03:00 am | 0 | - | - | 0 |
| 04:00 am | 0 | - | - | 0 |
| 05:00 am | 2 | - | - | 2 |
| 06:00 am | 1 | - | - | 1 |
| 07:00 am | 1 | - | - | 1 |
| 08:00 am | 2 | - | - | 2 |
| 09:00 am | 1 | - | - | 1 |
| 10:00 am | 3 | - | - | 3 |
| 11:00 am | 0 | - | - | 0 |
| 12:00 pm | 2 | - | - | 2 |
| 01:00 pm | 0 | - | - | 0 |
| 02:00 pm | 2 | - | - | 2 |
| 03:00 pm | 0 | - | - | 0 |
| 04:00 pm | 4 | - | - | 4 |
| 05:00 pm | 4 | - | - | 4 |
| 06:00 pm | 5 | - | - | 5 |
| 07:00 pm | 4 | - | - | 4 |
| 08:00 pm | 5 | - | - | 5 |
| 09:00 pm | 0 | - | - | 0 |
| 10:00 pm | 0 | - | - | 0 |
| 11:00 pm | 1 | - | - | 1 |
| 7am-7pm | 34 | - | - | 34 |
| 6am-10pm | 34 | - | - | 34 |
| 6am-12am | 35 | - | - | 35 |
| 12am-12am | 38 | - | - | 38 |
| am Peak | 10:00 am | - | - | - |
| Peak Volume | 3 | - | - | - |
| pm Peak | 08:00 pm | - | - | - |
| Peak Volume | 5 | - | - | - |

Event key: ■ QC failure ■ Atypical (QC) ■ Events ■ Special ■ Holiday ■ Other
■ Weekends and defined holidays

Notes on data:
 Weekly (7-day) averages are weighted by each day of the week.
 Holidays & Events:
 None

Data prepared by Drakewell US 01N - Nevada May 13, 2022 4:15:57 PM



Multi-Day Volume Report 139-0214 Tuesday, July 24, 2018

Multi-Day Volume Report 139-0214 Tuesday, July 24, 2018

Toggle All
 Tue Jul 24
 Average Workday
 Average 7 Day

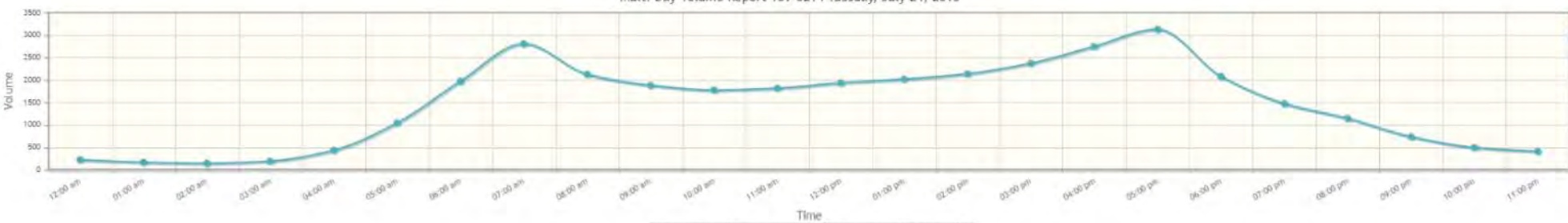

Switch chart type | Open in new window | Export as image | Hide graph

Site Name: 139-0214 | Site ID: 0000139_0214 | Description: CRX 129800

All Lanes | Time Period: 1 hour | Class: Any | Exclude data: None

| | Tue Jul 24 | Average Workday | Total |
|-------------|------------|-----------------|-------|
| 12:00 am | 222 | - | 222 |
| 01:00 am | 165 | - | 165 |
| 02:00 am | 143 | - | 143 |
| 03:00 am | 191 | - | 191 |
| 04:00 am | 433 | - | 433 |
| 05:00 am | 1041 | - | 1041 |
| 06:00 am | 1968 | - | 1968 |
| 07:00 am | 2804 | - | 2804 |
| 08:00 am | 2125 | - | 2125 |
| 09:00 am | 1879 | - | 1879 |
| 10:00 am | 1774 | - | 1774 |
| 11:00 am | 1815 | - | 1815 |
| 12:00 pm | 1933 | - | 1933 |
| 01:00 pm | 2018 | - | 2018 |
| 02:00 pm | 2136 | - | 2136 |
| 03:00 pm | 2371 | - | 2371 |
| 04:00 pm | 2745 | - | 2745 |
| 05:00 pm | 3126 | - | 3126 |
| 06:00 pm | 2078 | - | 2078 |
| 07:00 pm | 1472 | - | 1472 |
| 08:00 pm | 1141 | - | 1141 |
| 09:00 pm | 734 | - | 734 |
| 10:00 pm | 494 | - | 494 |
| 11:00 pm | 468 | - | 468 |
| 7am-7pm | 26804 | - | 26804 |
| 6am-10pm | 32119 | - | 32119 |
| 6am-12am | 33021 | - | 33021 |
| 12am-12am | 35216 | - | 35216 |
| am Peak | 07:00 am | - | - |
| Peak Volume | 2804 | - | - |
| pm Peak | 05:00 pm | - | - |
| Peak Volume | 3126 | - | - |

Event key: ■ QC failure ■ Atypical (QC) ■ Events ■ Special ■ Holiday ■ Other
■ Weekends and defined holidays

Notes on data:
 Weekly (7-day) averages are weighted by each day of the week.
 Holidays & Events:
 None

Data prepared by Drakewell US 01N - Nevada May 13, 2022 4:18:48 PM

C2 > GDOT_PORTABLES > Sites > 0000139_0214 (139-0214) > Multi-Day Volume Report 139-0214 Tuesday, July 24, 2018 Report

C2-Cloud Traffic Data ©2003-2022 Drakewell Ltd

Version 22.04.28.190328



Multi-Day Volume Report 139-0225 Wednesday, July 25, 2018

Multi-Day Volume Report 139-0225 Wednesday, July 25, 2018



Toggle All

Wed Jul 25

Average Weekday

Average 7 Day

Switch chart type | Open in new window | Export as image | Hide graph

Site Name: 139-0225 Site ID: 0000139_0225 Description: CRT 084900 R

All Lanes | Time Period: 1 hour | Class: Any | Exclude data: None

| | Wed Jul 25 | Average Weekday | Total Count |
|-------------|------------|-----------------|-------------|
| 12:00 am | 10 | - | 10 |
| 01:00 am | 20 | - | 20 |
| 02:00 am | 17 | - | 17 |
| 03:00 am | 8 | - | 8 |
| 04:00 am | 29 | - | 29 |
| 05:00 am | 95 | - | 95 |
| 06:00 am | 210 | - | 210 |
| 07:00 am | 290 | - | 290 |
| 08:00 am | 239 | - | 239 |
| 09:00 am | 191 | - | 191 |
| 10:00 am | 184 | - | 184 |
| 11:00 am | 193 | - | 193 |
| 12:00 pm | 210 | - | 210 |
| 01:00 pm | 203 | - | 203 |
| 02:00 pm | 238 | - | 238 |
| 03:00 pm | 291 | - | 291 |
| 04:00 pm | 324 | - | 324 |
| 05:00 pm | 411 | - | 411 |
| 06:00 pm | 322 | - | 322 |
| 07:00 pm | 256 | - | 256 |
| 08:00 pm | 171 | - | 171 |
| 09:00 pm | 186 | - | 186 |
| 10:00 pm | 93 | - | 93 |
| 11:00 pm | 39 | - | 39 |
| 7am-7pm | 3126 | - | 3126 |
| 6am-10pm | 3949 | - | 3949 |
| 6am-12am | 4081 | - | 4081 |
| 12am-12am | 1260 | - | 1260 |
| am Peak | 07:00 am | - | - |
| Peak Volume | 290 | - | - |
| pm Peak | 05:00 pm | - | - |
| Peak Volume | 411 | - | - |

Event key: QC failure, Atypical (QC), Events, Special, Holiday, Other, Weekends and defined holidays

Notes on data: Weekly (7-day) averages are weighted by each day of the week.

Holidays & Events: None

Appendix I: Trip Generation

ADT-001 ADT-002 TC-139_8203
 38014 4506 94 42614
 0.89205425 0.1057399 0.002205848

| | |
|--------|--------|
| Gate 1 | 89.00% |
| Gate 2 | 10.00% |
| Gate 3 | 1.00% |

Total
 Gate 1
 Gate 2
 Gate 3

| Trip Generation: Combined | | | | | | |
|---------------------------------|-------|------|---------------------------------|-------|------|--|
| AM Peak Hour of Adjacent Street | | | PM Peak Hour of Adjacent Street | | | |
| Total | Enter | Exit | Total | Enter | Exit | |
| 240 | 61 | 179 | 318 | 200 | 118 | |
| 214 | 54 | 160 | 283 | 178 | 105 | |
| 24 | 6 | 18 | 32 | 20 | 12 | |
| 2 | 1 | 1 | 3 | 2 | 1 | |

next, adt for each gate
 am peak hour
 calc percent for each direction
 will tell you percent traveling n and s
 which will tell you percent entering
 which is sbi and nbr

| AM | | | PM | | |
|------|-------|--------|------|-------|--------|
| N | 5227 | 34.5% | N | 14191 | 62.0% |
| S | 9906 | 65.5% | S | 8690 | 38.0% |
| Sum: | 15133 | 100.0% | Sum: | 22881 | 100.0% |

Gate 2
 ADT 3

| AM | | | PM | | |
|------|----|--------|------|----|--------|
| N | 37 | 62.7% | N | 28 | 37.3% |
| S | 22 | 37.3% | S | 47 | 62.7% |
| Sum: | 59 | 100.0% | Sum: | 75 | 100.0% |

Distribute through Entering and Exiting Volume

Gate 1

| Scenario | Trip Distribution Along US 23/SR 365/Cornelia Hwy | | | | |
|----------|---|--------------|----------------|--------------|----------------|
| | Total | To the North | From the North | To the South | From the South |
| AM | 214 | 55 | 19 | 105 | 35 |
| PM | 283 | 40 | 68 | 65 | 110 |

Gate 2

| Scenario | Trip Distribution Along Cagle Mill Rd | | | | |
|----------|---------------------------------------|--------------|----------------|--------------|----------------|
| | Total | To the North | From the North | To the South | From the South |
| AM | 24 | 6 | 2 | 12 | 4 |
| PM | 32 | 5 | 8 | 7 | 12 |

Gate 3

| Scenario | Trip Distribution Along Whitehall Rd | | | | |
|----------|--------------------------------------|-------------|---------------|-------------|---------------|
| | Total | To the East | From the East | To the West | From the West |
| AM | N | 1 | 1 | 0 | 0 |
| PM | N | 1 | 2 | 0 | 0 |

Appendix J: Trip Distribution

From US 23/SR 365/Cornelia Highway Driveway

| Peak Hr | Gate 1/TMC 1 | | | | | | | | | | | | | | Sum | | |
|---------|--------------|-----|-----|----|-----|-----|-----|----|-----|-----|-----|----|-----|-----|-----|-----|----|
| | NB | | | | SB | | | | EB | | | | WB | | | | |
| | NBL | NBT | NBR | NB | SBL | SBT | SBR | SB | EBL | EBT | EBR | EB | WBL | WBT | | WBR | WB |
| AM | | | 22 | | 12 | | | | | | | | 66 | | 35 | | |
| PM | | | 68 | | 41 | | | | | | | | 39 | | 24 | | |

Add above to TMC 1

SBL comes from TMC 6 north of TMC 1
So add volume to TMC 6, that can make the movement to the south

| | AM | PM |
|-------|----|----|
| Enter | 35 | 24 |
| Exit | 12 | 41 |

Enter

| Feeder | SBL: To South, From TMC 6, to TMC 1 | | | | | |
|--------|-------------------------------------|---------|-------|-------|---------|-------|
| | AM | | | PM | | |
| | Value | Percent | Distr | Value | Percent | Distr |
| WBL | 21 | 1.00% | 0 | 12 | 1.20% | 0 |
| EBR | 1 | 0.05% | 0 | 4 | 0.40% | 0 |
| SBT | 2074 | 98.95% | 12 | 987 | 98.40% | 41 |
| Total | 2096 | 100% | 12 | 1003 | 100% | 41 |

Add 12 to SBT TMC 6 in AM
Add 41 to SBT TMC 6 in PM

Done
SBT do not come from anywhere else

WBR feeds into TMC 6

Exit

| Feeder | WBR: To North, From TMC 1 | | | | | |
|--------|---------------------------|---------|-------|-------|---------|-------|
| | AM | | | PM | | |
| | Value | Percent | Distr | Value | Percent | Distr |
| NBL | 0 | 0.00% | 0 | 2 | 0.08% | 0 |
| NBT | 828 | 100.00% | 35 | 2346 | 98.90% | 24 |
| NBR | 0 | 0.00% | 0 | 24 | 1.01% | 0 |
| Total | 828 | 100% | 35 | 2372 | 100% | 24 |

Add 35 to NBT in TMC 6 in AM
Add 24 to NBT in TMC 6 in PM

Add 22 to NBR in TMC 1 in AM
Add 12 to SBL in TMC 1 in AM
Add 66 to WBL in TMC 1 in AM
Add 35 to WBR in TMC 1 in AM

Add 68 to NBR in TMC 1 in PM
Add 41 to SBL in TMC 1 in PM
Add 39 to WBL in TMC 1 in PM
Add 24 to WBR in TMC 1 in PM













| Peak Hr | TMC 6 | | | | | | | | | | | | | | Sum | | | |
|---------|---------|-------|--------|-------|--------|-------|--------|-------|--------|-------|-------|-------|-------|-------|-------|-------|-------|------|
| | NB | | | | SB | | | | EB | | | | WB | | | | | |
| | NBL | NBT | NBR | NB | SBL | SBT | SBR | SB | EBL | EBT | EBR | EB | WBL | WBT | | WBR | WB | |
| AM | AM Vol | 0 | 828 | 0 | 828 | 0 | 2074 | 2 | 2076 | 3 | 2 | 1 | 6 | 21 | 2 | 1 | 24 | 2934 |
| | Percent | 0.00% | 28.22% | 0.00% | 28.22% | 0.00% | 70.69% | 0.07% | 70.76% | 0.10% | 0.07% | 0.03% | 0.20% | 0.72% | 0.07% | 0.03% | 0.82% | 1 |
| PM | PM Vol | 2 | 2346 | 24 | 2372 | 1 | 987 | 4 | 992 | 6 | 1 | 4 | 11 | 12 | 0 | 4 | 16 | 3391 |
| | Percent | 0.06% | 69.18% | 0.71% | 69.95% | 0.03% | 29.11% | 0.12% | 29.25% | 0.18% | 0.03% | 0.12% | 0.32% | 0.35% | 0.00% | 0.12% | 0.47% | 1 |

| Peak Hr | TMC 6 | | | | | | | | | | | | | | Sum | | | |
|---------|---------|-------|--------|-------|--------|-------|--------|-------|--------|-------|-------|-------|-------|-------|-------|-------|-------|------|
| | NB | | | | SB | | | | EB | | | | WB | | | | | |
| | NBL | NBT | NBR | NB | SBL | SBT | SBR | SB | EBL | EBT | EBR | EB | WBL | WBT | | WBR | WB | |
| AM | AM Vol | 0 | 828 | 0 | 828 | 0 | 2074 | 2 | 2076 | 3 | 2 | 1 | 6 | 21 | 2 | 1 | 24 | 2934 |
| | Percent | 0.00% | 28.22% | 0.00% | 28.22% | 0.00% | 70.69% | 0.07% | 70.76% | 0.10% | 0.07% | 0.03% | 0.20% | 0.72% | 0.07% | 0.03% | 0.82% | 1 |
| PM | PM Vol | 2 | 2346 | 24 | 2372 | 1 | 987 | 4 | 992 | 6 | 1 | 4 | 11 | 12 | 0 | 4 | 16 | 3391 |
| | Percent | 0.06% | 69.18% | 0.71% | 69.95% | 0.03% | 29.11% | 0.12% | 29.25% | 0.18% | 0.03% | 0.12% | 0.32% | 0.35% | 0.00% | 0.12% | 0.47% | 1 |

Appendix K: Capacity Analysis

HCM Unsignalized Intersection Capacity Analysis
 1: US 23/Cornelia Hwy & Americold Logistics Driveway

05/13/2022

| |  |  |  |  |  |  |  | |
|------------------------|---|---|---|---|---|---|---|------|
| Movement | EBL | EBR | NBL | NBT | SBU | SBT | SBR | |
| Lane Configurations |  | |  |  |  |  |  | |
| Traffic Volume (veh/h) | 6 | 18 | 57 | 864 | 1 | 2167 | 33 | |
| Future Volume (Veh/h) | 6 | 18 | 57 | 864 | 1 | 2167 | 33 | |
| Sign Control | Stop | | | Free | | Free | | |
| Grade | 0% | | | 0% | | 0% | | |
| Peak Hour Factor | 0.86 | 0.86 | 0.86 | 0.86 | 0.86 | 0.86 | 0.86 | |
| Hourly flow rate (vph) | 7 | 21 | 66 | 1005 | 0 | 2520 | 38 | |
| Pedestrians | | | | | | | | |
| Lane Width (ft) | | | | | | | | |
| Walking Speed (ft/s) | | | | | | | | |
| Percent Blockage | | | | | | | | |
| Right turn flare (veh) | | | | | | | | |
| Median type | | | | None | None | | | |
| Median storage (veh) | | | | | | | | |
| Upstream signal (ft) | | | | | | | | |
| pX, platoon unblocked | | | | | 0.00 | | | |
| vC, conflicting volume | 3154 | 1260 | 2558 | 0 | | | | |
| vC1, stage 1 conf vol | | | | | | | | |
| vC2, stage 2 conf vol | | | | | | | | |
| vCu, unblocked vol | 3154 | 1260 | 2558 | 0 | | | | |
| tC, single (s) | 7.1 | 7.2 | 4.3 | 0.0 | | | | |
| tC, 2 stage (s) | | | | | | | | |
| tF (s) | 3.7 | 3.5 | 2.3 | 0.0 | | | | |
| p0 queue free % | 0 | 85 | 55 | 0 | | | | |
| cM capacity (veh/h) | 3 | 142 | 147 | 0 | | | | |
| Direction, Lane # | EB 1 | NB 1 | NB 2 | NB 3 | SB 1 | SB 2 | SB 3 | SB 4 |
| Volume Total | 28 | 66 | 502 | 502 | 1260 | 1260 | 38 | 0 |
| Volume Left | 7 | 66 | 0 | 0 | 0 | 0 | 0 | 0 |
| Volume Right | 21 | 0 | 0 | 0 | 0 | 0 | 38 | 0 |
| cSH | 13 | 147 | 1700 | 1700 | 1700 | 1700 | 1700 | 1700 |
| Volume to Capacity | 2.16 | 0.45 | 0.30 | 0.30 | 0.74 | 0.74 | 0.02 | 0.00 |
| Queue Length 95th (ft) | 108 | 51 | 0 | 0 | 0 | 0 | 0 | 0 |
| Control Delay (s) | 1124.7 | 47.9 | 0.0 | 0.0 | 0.0 | 0.0 | 0.0 | 0.0 |

HCM Unsignalized Intersection Capacity Analysis

1: US 23/Cornelia Hwy & Americold Logistics Driveway

05/13/2022

| | | | |
|--------------------|--------|-----|-----|
| Lane LOS | F | E | |
| Approach Delay (s) | 1124.7 | 3.0 | 0.0 |
| Approach LOS | F | | |

| | | | |
|-----------------------------------|--|-------|------------------------|
| Intersection Summary | | | |
| Average Delay | | 9.5 | |
| Intersection Capacity Utilization | | 69.9% | ICU Level of Service C |
| Analysis Period (min) | | 15 | |

HCM Unsignalized Intersection Capacity Analysis

3: Cagle Mill Rd & Julian Baugh Rd

05/13/2022

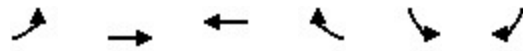

| Movement | EBL | EBT | WBT | WBR | SBL | SBR |
|------------------------|------|------|------|------|------|------|
| Lane Configurations | ↰ | | ↱ | | | ↰ |
| Traffic Volume (veh/h) | 4 | 0 | 1 | 11 | 5 | 3 |
| Future Volume (Veh/h) | 4 | 0 | 1 | 11 | 5 | 3 |
| Sign Control | | Stop | Stop | | Free | |
| Grade | | 0% | 0% | | 0% | |
| Peak Hour Factor | 0.72 | 0.72 | 0.72 | 0.72 | 0.72 | 0.72 |
| Hourly flow rate (vph) | 6 | 0 | 1 | 15 | 7 | 4 |
| Pedestrians | | | | | | |
| Lane Width (ft) | | | | | | |
| Walking Speed (ft/s) | | | | | | |
| Percent Blockage | | | | | | |
| Right turn flare (veh) | | | | | | |
| Median type | | | | None | | |
| Median storage (veh) | | | | | | |
| Upstream signal (ft) | | | | | | |
| pX, platoon unblocked | | | | | | |
| vC, conflicting volume | 30 | 14 | 18 | 0 | 0 | |
| vC1, stage 1 conf vol | | | | | | |
| vC2, stage 2 conf vol | | | | | | |
| vCu, unblocked vol | 30 | 14 | 18 | 0 | 0 | |
| tC, single (s) | 7.1 | 6.5 | 6.5 | 6.2 | 4.1 | |
| tC, 2 stage (s) | | | | | | |
| tF (s) | 3.5 | 4.0 | 4.0 | 3.3 | 2.2 | |
| p0 queue free % | 99 | 100 | 100 | 99 | 100 | |
| cM capacity (veh/h) | 967 | 881 | 876 | 1091 | 1636 | |
| Direction, Lane # | EB 1 | WB 1 | SB 1 | | | |
| Volume Total | 6 | 16 | 11 | | | |
| Volume Left | 6 | 0 | 7 | | | |
| Volume Right | 0 | 15 | 4 | | | |
| cSH | 967 | 1074 | 1636 | | | |
| Volume to Capacity | 0.01 | 0.01 | 0.00 | | | |
| Queue Length 95th (ft) | 0 | 1 | 0 | | | |
| Control Delay (s) | 8.7 | 8.4 | 4.6 | | | |

HCM Unsignalized Intersection Capacity Analysis

3: Cagle Mill Rd & Julian Baugh Rd

05/13/2022

| | | | |
|--------------------|-----|-----|-----|
| Lane LOS | A | A | A |
| Approach Delay (s) | 8.7 | 8.4 | 4.6 |
| Approach LOS | A | A | |

Intersection Summary

| | | | | |
|-----------------------------------|--|------|----------------------|---|
| Average Delay | | 7.2 | | |
| Intersection Capacity Utilization | | Err% | ICU Level of Service | H |
| Analysis Period (min) | | 15 | | |

HCM 6th TWSC
2: Julian Baugh Rd & Cagle Rd

05/13/2022

| Intersection | | | | | | |
|--------------------------|------|------|------|------|------|------|
| Int Delay, s/veh | 4.4 | | | | | |
| Movement | EBT | EBR | WBL | WBT | NBL | NBR |
| Lane Configurations | ↑ | | | ↑ | ↑ | |
| Traffic Vol, veh/h | 3 | 6 | 2 | 7 | 14 | 1 |
| Future Vol, veh/h | 3 | 6 | 2 | 7 | 14 | 1 |
| Conflicting Peds, #/hr | 0 | 0 | 0 | 0 | 0 | 0 |
| Sign Control | Free | Free | Free | Free | Stop | Stop |
| RT Channelized | - | None | - | None | - | None |
| Storage Length | - | - | - | - | 0 | - |
| Veh in Median Storage, # | 0 | - | - | 0 | 0 | - |
| Grade, % | 0 | - | - | 0 | 0 | - |
| Peak Hour Factor | 62 | 62 | 62 | 62 | 62 | 62 |
| Heavy Vehicles, % | 0 | 0 | 0 | 0 | 0 | 0 |
| Mvmt Flow | 5 | 10 | 3 | 11 | 23 | 2 |

| Major/Minor | Major1 | Major2 | Minor1 | Minor2 | Minor3 |
|----------------------|--------|--------|--------|--------|--------|
| Conflicting Flow All | 0 | 0 | 15 | 0 | 27 |
| Stage 1 | - | - | - | - | 10 |
| Stage 2 | - | - | - | - | 17 |
| Critical Hdwy | - | - | 4.1 | - | 6.4 |
| Critical Hdwy Stg 1 | - | - | - | - | 5.4 |
| Critical Hdwy Stg 2 | - | - | - | - | 5.4 |
| Follow-up Hdwy | - | - | 2.2 | - | 3.5 |
| Pot Cap-1 Maneuver | - | - | 1616 | - | 993 |
| Stage 1 | - | - | - | - | 1018 |
| Stage 2 | - | - | - | - | 1011 |
| Platoon blocked, % | - | - | - | - | - |
| Mov Cap-1 Maneuver | - | - | 1616 | - | 991 |
| Mov Cap-2 Maneuver | - | - | - | - | 991 |
| Stage 1 | - | - | - | - | 1018 |
| Stage 2 | - | - | - | - | 1009 |

HCM 6th TWSC

2: Julian Baugh Rd & Cagle Rd

05/13/2022

| Approach | EB | WB | NB | | |
|-----------------------|-------|-----|-----|-------|-----|
| HCM Control Delay, s | 0 | 1.6 | 8.7 | | |
| HCM LOS | | | A | | |
| | | | | | |
| Minor Lane/Major Mvmt | NBLn1 | EBT | EBR | WBL | WBT |
| Capacity (veh/h) | 996 | - | - | 1616 | - |
| HCM Lane V/C Ratio | 0.024 | - | - | 0.002 | - |
| HCM Control Delay (s) | 8.7 | - | - | 7.2 | 0 |
| HCM Lane LOS | A | - | - | A | A |
| HCM 95th %tile Q(veh) | 0.1 | - | - | 0 | - |

HCM 6th TWSC
4: Noah Martin Rd & Whitehall Rd

05/13/2022

| Intersection | | | | | | | | | | | | |
|--------------------------|------|------|------|------|------|------|------|------|------|------|------|------|
| Int Delay, s/veh | 6.4 | | | | | | | | | | | |
| Movement | EBL | EBT | EBR | WBL | WBT | WBR | NBL | NBT | NBR | SBL | SBT | SBR |
| Lane Configurations | | ↕ | | | ↕ | | | ↕ | | | ↕ | |
| Traffic Vol, veh/h | 1 | 4 | 2 | 0 | 16 | 2 | 1 | 1 | 1 | 1 | 7 | 2 |
| Future Vol, veh/h | 1 | 4 | 2 | 0 | 16 | 2 | 1 | 1 | 1 | 1 | 7 | 2 |
| Conflicting Peds, #/hr | 0 | 0 | 0 | 0 | 0 | 0 | 0 | 0 | 0 | 0 | 0 | 0 |
| Sign Control | Stop | Stop | Stop | Stop | Stop | Stop | Free | Free | Free | Free | Free | Free |
| RT Channelized | - | - | None | - | - | None | - | - | None | - | - | None |
| Storage Length | - | - | - | - | - | - | - | - | - | - | - | - |
| Veh in Median Storage, # | - | 0 | - | - | 0 | - | - | 0 | - | - | 0 | - |
| Grade, % | - | 0 | - | - | 0 | - | - | 0 | - | - | 0 | - |
| Peak Hour Factor | 79 | 79 | 79 | 79 | 79 | 79 | 79 | 79 | 79 | 79 | 79 | 79 |
| Heavy Vehicles, % | 14 | 14 | 14 | 6 | 6 | 6 | 33 | 33 | 33 | 10 | 10 | 10 |
| Mvmt Flow | 1 | 5 | 3 | 0 | 20 | 3 | 1 | 1 | 1 | 1 | 9 | 3 |

| Major/Minor | Minor2 | | | Minor1 | | | Major1 | | | Major2 | | |
|----------------------|--------|-------|-------|--------|-------|-------|--------|---|---|--------|---|---|
| Conflicting Flow All | 28 | 17 | 11 | 21 | 18 | 2 | 12 | 0 | 0 | 2 | 0 | 0 |
| Stage 1 | 13 | 13 | - | 4 | 4 | - | - | - | - | - | - | - |
| Stage 2 | 15 | 4 | - | 17 | 14 | - | - | - | - | - | - | - |
| Critical Hdwy | 7.24 | 6.64 | 6.34 | 7.16 | 6.56 | 6.26 | 4.43 | - | - | 4.2 | - | - |
| Critical Hdwy Stg 1 | 6.24 | 5.64 | - | 6.16 | 5.56 | - | - | - | - | - | - | - |
| Critical Hdwy Stg 2 | 6.24 | 5.64 | - | 6.16 | 5.56 | - | - | - | - | - | - | - |
| Follow-up Hdwy | 3.626 | 4.126 | 3.426 | 3.554 | 4.054 | 3.354 | 2.497 | - | - | 2.29 | - | - |
| Pot Cap-1 Maneuver | 952 | 854 | 1036 | 982 | 868 | 1071 | 1427 | - | - | 1569 | - | - |
| Stage 1 | 977 | 861 | - | 1008 | 885 | - | - | - | - | - | - | - |
| Stage 2 | 975 | 869 | - | 992 | 876 | - | - | - | - | - | - | - |
| Platoon blocked, % | | | | | | | | | | | | |
| Mov Cap-1 Maneuver | 931 | 852 | 1036 | 974 | 866 | 1071 | 1427 | - | - | 1569 | - | - |
| Mov Cap-2 Maneuver | 931 | 852 | - | 974 | 866 | - | - | - | - | - | - | - |
| Stage 1 | 976 | 860 | - | 1007 | 884 | - | - | - | - | - | - | - |
| Stage 2 | 949 | 868 | - | 983 | 875 | - | - | - | - | - | - | - |

HCM 6th TWSC

4: Noah Martin Rd & Whitehall Rd

05/13/2022

| Approach | EB | WB | | NB | | SB | | |
|-----------------------|-------|-----|-----|-------|-------|-------|-----|-----|
| HCM Control Delay, s | 9 | 9.2 | | 2.5 | | 0.7 | | |
| HCM LOS | A | A | | | | | | |
| | | | | | | | | |
| Minor Lane/Major Mvmt | NBL | NBT | NBR | EBLn1 | WBLn1 | SBL | SBT | SBR |
| Capacity (veh/h) | 1427 | - | - | 909 | 885 | 1569 | - | - |
| HCM Lane V/C Ratio | 0.001 | - | - | 0.01 | 0.026 | 0.001 | - | - |
| HCM Control Delay (s) | 7.5 | 0 | - | 9 | 9.2 | 7.3 | 0 | - |
| HCM Lane LOS | A | A | - | A | A | A | A | - |
| HCM 95th %tile Q(veh) | 0 | - | - | 0 | 0.1 | 0 | - | - |

HCM 6th TWSC
 5: Old Cornelia Hwy & Noah Martin Rd

05/13/2022

| Intersection | | | | | | |
|--------------------------|------|------|------|------|------|------|
| Int Delay, s/veh | 0.2 | | | | | |
| Movement | EBL | EBT | WBT | WBR | SBL | SBR |
| Lane Configurations | | ← | ← | | ← | |
| Traffic Vol, veh/h | 0 | 82 | 373 | 2 | 1 | 7 |
| Future Vol, veh/h | 0 | 82 | 373 | 2 | 1 | 7 |
| Conflicting Peds, #/hr | 0 | 0 | 0 | 0 | 0 | 0 |
| Sign Control | Free | Free | Free | Free | Stop | Stop |
| RT Channelized | - | None | - | None | - | None |
| Storage Length | - | - | - | - | 0 | - |
| Veh in Median Storage, # | - | 0 | 0 | - | 0 | - |
| Grade, % | - | 0 | 0 | - | 0 | - |
| Peak Hour Factor | 89 | 89 | 89 | 89 | 89 | 89 |
| Heavy Vehicles, % | 9 | 9 | 3 | 3 | 13 | 13 |
| Mvmt Flow | 0 | 92 | 419 | 2 | 1 | 8 |

| Major/Minor | Major1 | Major2 | Minor2 |
|----------------------|--------|--------|--------|
| Conflicting Flow All | 421 | 0 | 512 |
| Stage 1 | - | - | 420 |
| Stage 2 | - | - | 92 |
| Critical Hdwy | 4.19 | - | 6.53 |
| Critical Hdwy Stg 1 | - | - | 5.53 |
| Critical Hdwy Stg 2 | - | - | 5.53 |
| Follow-up Hdwy | 2.281 | - | 3.617 |
| Pot Cap-1 Maneuver | 1102 | - | 503 |
| Stage 1 | - | - | 640 |
| Stage 2 | - | - | 905 |
| Platoon blocked, % | - | - | - |
| Mov Cap-1 Maneuver | 1102 | - | 503 |
| Mov Cap-2 Maneuver | - | - | 503 |
| Stage 1 | - | - | 640 |
| Stage 2 | - | - | 905 |

HCM 6th TWSC

5: Old Cornelia Hwy & Noah Martin Rd

05/13/2022

| Approach | EB | WB | SB |
|----------------------|----|----|------|
| HCM Control Delay, s | 0 | 0 | 11.2 |
| HCM LOS | | | B |

| Minor Lane/Major Mvmt | EBL | EBT | WBT | WBR | SBLn1 |
|-----------------------|------|-----|-----|-----|-------|
| Capacity (veh/h) | 1102 | - | - | - | 594 |
| HCM Lane V/C Ratio | - | - | - | - | 0.015 |
| HCM Control Delay (s) | 0 | - | - | - | 11.2 |
| HCM Lane LOS | A | - | - | - | B |
| HCM 95th %tile Q(veh) | 0 | - | - | - | 0 |

HCM 6th TWSC
6: US 23/Cornelia Hwy & Cagle Rd

05/13/2022

| Intersection | | | | | | | | | | | | |
|--------------------------|------|------|------|------|------|------|------|------|------|------|------|------|
| Int Delay, s/veh | 11.4 | | | | | | | | | | | |
| Movement | EBL | EBT | EBR | WBL | WBT | WBR | NBL | NBT | NBR | SBL | SBT | SBR |
| Lane Configurations | | ↔ | | | ↔ | | ↑ | ↑↑ | ↑ | ↑ | ↑↑ | ↑ |
| Traffic Vol, veh/h | 2 | 0 | 1 | 22 | 2 | 1 | 0 | 778 | 0 | 0 | 2178 | 2 |
| Future Vol, veh/h | 2 | 0 | 1 | 22 | 2 | 1 | 0 | 778 | 0 | 0 | 2178 | 2 |
| Conflicting Peds, #/hr | 0 | 0 | 0 | 0 | 0 | 0 | 0 | 0 | 0 | 0 | 0 | 0 |
| Sign Control | Stop | Stop | Stop | Stop | Stop | Stop | Free | Free | Free | Free | Free | Free |
| RT Channelized | - | - | None | - | - | None | - | - | None | - | - | None |
| Storage Length | - | - | - | - | - | - | 315 | - | 280 | 517 | - | - |
| Veh in Median Storage, # | - | 0 | - | - | 0 | - | - | 0 | - | - | 0 | - |
| Grade, % | - | 0 | - | - | 0 | - | - | 0 | - | - | 0 | - |
| Peak Hour Factor | 85 | 85 | 85 | 85 | 85 | 85 | 85 | 85 | 85 | 85 | 85 | 85 |
| Heavy Vehicles, % | 50 | 50 | 50 | 0 | 0 | 0 | 11 | 11 | 11 | 4 | 4 | 4 |
| Mvmt Flow | 2 | 0 | 1 | 26 | 2 | 1 | 0 | 915 | 0 | 0 | 2562 | 2 |

| Major/Minor | Minor2 | | Minor1 | | | Major1 | | Major2 | | | | |
|----------------------|--------|------|--------|------|------|--------|------|--------|---|------|---|---|
| Conflicting Flow All | 3021 | 3477 | 1281 | 2196 | 3479 | 458 | 2564 | 0 | 0 | 915 | 0 | 0 |
| Stage 1 | 2562 | 2562 | - | 915 | 915 | - | - | - | - | - | - | - |
| Stage 2 | 459 | 915 | - | 1281 | 2564 | - | - | - | - | - | - | - |
| Critical Hdwy | 8.5 | 7.5 | 7.9 | 7.5 | 6.5 | 6.9 | 4.32 | - | - | 4.18 | - | - |
| Critical Hdwy Stg 1 | 7.5 | 6.5 | - | 6.5 | 5.5 | - | - | - | - | - | - | - |
| Critical Hdwy Stg 2 | 7.5 | 6.5 | - | 6.5 | 5.5 | - | - | - | - | - | - | - |
| Follow-up Hdwy | 4 | 4.5 | 3.8 | 3.5 | 4 | 3.3 | 2.31 | - | - | 2.24 | - | - |
| Pot Cap-1 Maneuver | ~ 2 | 3 | 104 | 26 | 7 | 555 | 146 | - | - | 729 | - | - |
| Stage 1 | 13 | 26 | - | 298 | 354 | - | - | - | - | - | - | - |
| Stage 2 | 442 | 257 | - | 178 | 54 | - | - | - | - | - | - | - |
| Platoon blocked, % | | | | | | | | - | - | - | - | - |
| Mov Cap-1 Maneuver | ~ 1 | 3 | 104 | 26 | 7 | 555 | 146 | - | - | 729 | - | - |
| Mov Cap-2 Maneuver | ~ 1 | 3 | - | 26 | 7 | - | - | - | - | - | - | - |
| Stage 1 | 13 | 26 | - | 298 | 354 | - | - | - | - | - | - | - |
| Stage 2 | 438 | 257 | - | 176 | 54 | - | - | - | - | - | - | - |

HCM 6th TWSC
6: US 23/Cornelia Hwy & Cagle Rd

05/13/2022

| Approach | EB | WB | | NB | | SB | | |
|-----------------------|-----------|----------|-----|-----------|----------|-----|-----|-----|
| HCM Control Delay, s | \$ 6632.1 | \$ 567.2 | | 0 | | 0 | | |
| HCM LOS | F | F | | | | | | |
| | | | | | | | | |
| Minor Lane/Major Mvmt | NBL | NBT | NBR | EBLn1 | WBLn1 | SBL | SBT | SBR |
| Capacity (veh/h) | 146 | - | - | 1 | 22 | 729 | - | - |
| HCM Lane V/C Ratio | - | - | - | 3.529 | 1.337 | - | - | - |
| HCM Control Delay (s) | 0 | - | - | \$ 6632.1 | \$ 567.2 | 0 | - | - |
| HCM Lane LOS | A | - | - | F | F | A | - | - |
| HCM 95th %tile Q(veh) | 0 | - | - | 1.3 | 3.8 | 0 | - | - |

Notes

~: Volume exceeds capacity \$: Delay exceeds 300s +: Computation Not Defined *: All major volume in platoon

HCM Unsignalized Intersection Capacity Analysis
 1: US 23/Cornelia Hwy & Americold Logistics Driveway

05/13/2022



| Movement | EBL | EBR | NBL | NBT | SBU | SBT | SBR | |
|------------------------|-------|------|------|------|------|------|------|------|
| Lane Configurations | ↔ | | ↔ | ↑↑ | ↔ | ↑↑ | ↔ | |
| Traffic Volume (veh/h) | 19 | 25 | 6 | 2475 | 2 | 1035 | 8 | |
| Future Volume (Veh/h) | 19 | 25 | 6 | 2475 | 2 | 1035 | 8 | |
| Sign Control | Stop | | | Free | | Free | | |
| Grade | 0% | | | 0% | | 0% | | |
| Peak Hour Factor | 0.95 | 0.95 | 0.95 | 0.95 | 0.95 | 0.95 | 0.95 | |
| Hourly flow rate (vph) | 20 | 26 | 6 | 2605 | 0 | 1089 | 8 | |
| Pedestrians | | | | | | | | |
| Lane Width (ft) | | | | | | | | |
| Walking Speed (ft/s) | | | | | | | | |
| Percent Blockage | | | | | | | | |
| Right turn flare (veh) | | | | | | | | |
| Median type | | | | None | None | | | |
| Median storage (veh) | | | | | | | | |
| Upstream signal (ft) | | | | | | | | |
| pX, platoon unblocked | | | | | 0.00 | | | |
| vC, conflicting volume | 2404 | 544 | 1097 | 0 | | | | |
| vC1, stage 1 conf vol | | | | | | | | |
| vC2, stage 2 conf vol | | | | | | | | |
| vCu, unblocked vol | 2404 | 544 | 1097 | 0 | | | | |
| tC, single (s) | 7.2 | 7.3 | 4.2 | 0.0 | | | | |
| tC, 2 stage (s) | | | | | | | | |
| tF (s) | 3.7 | 3.5 | 2.2 | 0.0 | | | | |
| p0 queue free % | 7 | 94 | 99 | 0 | | | | |
| cM capacity (veh/h) | 22 | 441 | 620 | 0 | | | | |
| Direction, Lane # | EB 1 | NB 1 | NB 2 | NB 3 | SB 1 | SB 2 | SB 3 | SB 4 |
| Volume Total | 46 | 6 | 1302 | 1302 | 544 | 544 | 8 | 0 |
| Volume Left | 20 | 6 | 0 | 0 | 0 | 0 | 0 | 0 |
| Volume Right | 26 | 0 | 0 | 0 | 0 | 0 | 8 | 0 |
| cSH | 47 | 620 | 1700 | 1700 | 1700 | 1700 | 1700 | 1700 |
| Volume to Capacity | 0.99 | 0.01 | 0.77 | 0.77 | 0.32 | 0.32 | 0.00 | 0.00 |
| Queue Length 95th (ft) | 103 | 1 | 0 | 0 | 0 | 0 | 0 | 0 |
| Control Delay (s) | 264.6 | 10.9 | 0.0 | 0.0 | 0.0 | 0.0 | 0.0 | 0.0 |

HCM Unsignalized Intersection Capacity Analysis

1: US 23/Cornelia Hwy & Americold Logistics Driveway

05/13/2022

| | | | |
|--------------------|-------|-----|-----|
| Lane LOS | F | B | |
| Approach Delay (s) | 264.6 | 0.0 | 0.0 |
| Approach LOS | F | | |

| | | | |
|-----------------------------------|-------|----------------------|---|
| Intersection Summary | | | |
| Average Delay | | 3.3 | |
| Intersection Capacity Utilization | 78.4% | ICU Level of Service | D |
| Analysis Period (min) | 15 | | |

HCM Unsignalized Intersection Capacity Analysis
 3: Cagle Mill Rd & Julian Baugh Rd

05/13/2022

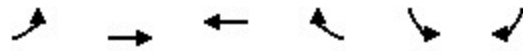

| Movement | EBL | EBT | WBT | WBR | SBL | SBR |
|------------------------|------|------|------|------|------|------|
| Lane Configurations | ↖ | | ↗ | | | ↖ |
| Traffic Volume (veh/h) | 2 | 0 | 1 | 11 | 22 | 2 |
| Future Volume (Veh/h) | 2 | 0 | 1 | 11 | 22 | 2 |
| Sign Control | | Stop | Stop | | Free | |
| Grade | | 0% | 0% | | 0% | |
| Peak Hour Factor | 0.75 | 0.75 | 0.75 | 0.75 | 0.75 | 0.75 |
| Hourly flow rate (vph) | 3 | 0 | 1 | 15 | 29 | 3 |
| Pedestrians | | | | | | |
| Lane Width (ft) | | | | | | |
| Walking Speed (ft/s) | | | | | | |
| Percent Blockage | | | | | | |
| Right turn flare (veh) | | | | | | |
| Median type | | | | None | | |
| Median storage (veh) | | | | | | |
| Upstream signal (ft) | | | | | | |
| pX, platoon unblocked | | | | | | |
| vC, conflicting volume | 74 | 58 | 61 | 0 | 0 | |
| vC1, stage 1 conf vol | | | | | | |
| vC2, stage 2 conf vol | | | | | | |
| vCu, unblocked vol | 74 | 58 | 61 | 0 | 0 | |
| tC, single (s) | 7.1 | 6.5 | 6.5 | 6.2 | 4.1 | |
| tC, 2 stage (s) | | | | | | |
| tF (s) | 3.5 | 4.0 | 4.0 | 3.3 | 2.2 | |
| p0 queue free % | 100 | 100 | 100 | 99 | 98 | |
| cM capacity (veh/h) | 896 | 822 | 819 | 1091 | 1636 | |
| Direction, Lane # | EB 1 | WB 1 | SB 1 | | | |
| Volume Total | 3 | 16 | 32 | | | |
| Volume Left | 3 | 0 | 29 | | | |
| Volume Right | 0 | 15 | 3 | | | |
| cSH | 896 | 1069 | 1636 | | | |
| Volume to Capacity | 0.00 | 0.01 | 0.02 | | | |
| Queue Length 95th (ft) | 0 | 1 | 1 | | | |
| Control Delay (s) | 9.0 | 8.4 | 6.6 | | | |

HCM Unsignalized Intersection Capacity Analysis

3: Cagle Mill Rd & Julian Baugh Rd

05/13/2022

| | | | |
|--------------------|-----|-----|-----|
| Lane LOS | A | A | A |
| Approach Delay (s) | 9.0 | 8.4 | 6.6 |
| Approach LOS | A | A | |

Intersection Summary

| | | | | |
|-----------------------------------|--|------|----------------------|---|
| Average Delay | | 7.3 | | |
| Intersection Capacity Utilization | | Err% | ICU Level of Service | H |
| Analysis Period (min) | | 15 | | |

HCM 6th TWSC
2: Julian Baugh Rd & Cagle Rd

05/13/2022

| Intersection | | | | | | |
|--------------------------|------|------|------|------|------|------|
| Int Delay, s/veh | 2.8 | | | | | |
| Movement | EBT | EBR | WBL | WBT | NBL | NBR |
| Lane Configurations | ↑ | | | ↑ | ↑ | |
| Traffic Vol, veh/h | 16 | 15 | 2 | 6 | 11 | 5 |
| Future Vol, veh/h | 16 | 15 | 2 | 6 | 11 | 5 |
| Conflicting Peds, #/hr | 0 | 0 | 0 | 0 | 0 | 0 |
| Sign Control | Free | Free | Free | Free | Stop | Stop |
| RT Channelized | - | None | - | None | - | None |
| Storage Length | - | - | - | - | 0 | - |
| Veh in Median Storage, # | 0 | - | - | 0 | 0 | - |
| Grade, % | 0 | - | - | 0 | 0 | - |
| Peak Hour Factor | 87 | 87 | 87 | 87 | 87 | 87 |
| Heavy Vehicles, % | 0 | 0 | 0 | 0 | 0 | 0 |
| Mvmt Flow | 18 | 17 | 2 | 7 | 13 | 6 |

| Major/Minor | Major1 | Major2 | Minor1 | Minor2 | Minor3 |
|----------------------|--------|--------|--------|--------|--------|
| Conflicting Flow All | 0 | 0 | 35 | 0 | 38 |
| Stage 1 | - | - | - | - | 27 |
| Stage 2 | - | - | - | - | 11 |
| Critical Hdwy | - | - | 4.1 | - | 6.4 |
| Critical Hdwy Stg 1 | - | - | - | - | 5.4 |
| Critical Hdwy Stg 2 | - | - | - | - | 5.4 |
| Follow-up Hdwy | - | - | 2.2 | - | 3.5 |
| Pot Cap-1 Maneuver | - | - | 1589 | - | 979 |
| Stage 1 | - | - | - | - | 1001 |
| Stage 2 | - | - | - | - | 1017 |
| Platoon blocked, % | - | - | - | - | - |
| Mov Cap-1 Maneuver | - | - | 1589 | - | 978 |
| Mov Cap-2 Maneuver | - | - | - | - | 978 |
| Stage 1 | - | - | - | - | 1001 |
| Stage 2 | - | - | - | - | 1016 |

HCM 6th TWSC

2: Julian Baugh Rd & Cagle Rd

05/13/2022

| Approach | EB | WB | NB | | | |
|-----------------------|-------|-----|-----|-------|-----|--|
| HCM Control Delay, s | 0 | 1.8 | 8.7 | | | |
| HCM LOS | | | | A | | |
| | | | | | | |
| Minor Lane/Major Mvmt | NBLn1 | EBT | EBR | WBL | WBT | |
| Capacity (veh/h) | 1001 | - | - | 1589 | - | |
| HCM Lane V/C Ratio | 0.018 | - | - | 0.001 | - | |
| HCM Control Delay (s) | 8.7 | - | - | 7.3 | 0 | |
| HCM Lane LOS | A | - | - | A | A | |
| HCM 95th %tile Q(veh) | 0.1 | - | - | 0 | - | |

HCM 6th TWSC
4: Noah Martin Rd & Whitehall Rd

05/13/2022

| Intersection | | | | | | | | | | | | |
|--------------------------|------|------|------|------|------|------|------|------|------|------|------|------|
| Int Delay, s/veh | 7 | | | | | | | | | | | |
| Movement | EBL | EBT | EBR | WBL | WBT | WBR | NBL | NBT | NBR | SBL | SBT | SBR |
| Lane Configurations | | ↕ | | | ↕ | | | ↕ | | | ↕ | |
| Traffic Vol, veh/h | 4 | 15 | 5 | 7 | 8 | 0 | 8 | 2 | 7 | 1 | 2 | 1 |
| Future Vol, veh/h | 4 | 15 | 5 | 7 | 8 | 0 | 8 | 2 | 7 | 1 | 2 | 1 |
| Conflicting Peds, #/hr | 0 | 0 | 0 | 0 | 0 | 0 | 0 | 0 | 0 | 0 | 0 | 0 |
| Sign Control | Stop | Stop | Stop | Stop | Stop | Stop | Free | Free | Free | Free | Free | Free |
| RT Channelized | - | - | None | - | - | None | - | - | None | - | - | None |
| Storage Length | - | - | - | - | - | - | - | - | - | - | - | - |
| Veh in Median Storage, # | - | 0 | - | - | 0 | - | - | 0 | - | - | 0 | - |
| Grade, % | - | 0 | - | - | 0 | - | - | 0 | - | - | 0 | - |
| Peak Hour Factor | 78 | 78 | 78 | 78 | 78 | 78 | 78 | 78 | 78 | 78 | 78 | 78 |
| Heavy Vehicles, % | 0 | 0 | 0 | 7 | 7 | 7 | 6 | 6 | 6 | 0 | 0 | 0 |
| Mvmt Flow | 5 | 19 | 6 | 9 | 10 | 0 | 10 | 3 | 9 | 1 | 3 | 1 |

| Major/Minor | Minor2 | | Minor1 | | Major1 | | Major2 | | | | | |
|----------------------|--------|-----|--------|-------|--------|-------|--------|---|---|------|---|---|
| Conflicting Flow All | 39 | 38 | 4 | 46 | 34 | 8 | 4 | 0 | 0 | 12 | 0 | 0 |
| Stage 1 | 6 | 6 | - | 28 | 28 | - | - | - | - | - | - | - |
| Stage 2 | 33 | 32 | - | 18 | 6 | - | - | - | - | - | - | - |
| Critical Hdwy | 7.1 | 6.5 | 6.2 | 7.17 | 6.57 | 6.27 | 4.16 | - | - | 4.1 | - | - |
| Critical Hdwy Stg 1 | 6.1 | 5.5 | - | 6.17 | 5.57 | - | - | - | - | - | - | - |
| Critical Hdwy Stg 2 | 6.1 | 5.5 | - | 6.17 | 5.57 | - | - | - | - | - | - | - |
| Follow-up Hdwy | 3.5 | 4 | 3.3 | 3.563 | 4.063 | 3.363 | 2.254 | - | - | 2.2 | - | - |
| Pot Cap-1 Maneuver | 971 | 858 | 1085 | 943 | 849 | 1060 | 1592 | - | - | 1620 | - | - |
| Stage 1 | 1021 | 895 | - | 976 | 862 | - | - | - | - | - | - | - |
| Stage 2 | 988 | 872 | - | 988 | 881 | - | - | - | - | - | - | - |
| Platoon blocked, % | | | | | | | | | | | | |
| Mov Cap-1 Maneuver | 956 | 852 | 1085 | 917 | 843 | 1060 | 1592 | - | - | 1620 | - | - |
| Mov Cap-2 Maneuver | 956 | 852 | - | 917 | 843 | - | - | - | - | - | - | - |
| Stage 1 | 1015 | 894 | - | 970 | 857 | - | - | - | - | - | - | - |
| Stage 2 | 970 | 867 | - | 960 | 880 | - | - | - | - | - | - | - |

HCM 6th TWSC

4: Noah Martin Rd & Whitehall Rd

05/13/2022

| Approach | EB | WB | | NB | | SB | | |
|-----------------------|-------|-----|-----|-------|-------|-------|-----|-----|
| HCM Control Delay, s | 9.1 | 9.2 | | 3.4 | | 1.8 | | |
| HCM LOS | A | A | | | | | | |
| | | | | | | | | |
| Minor Lane/Major Mvmt | NBL | NBT | NBR | EBLn1 | WBLn1 | SBL | SBT | SBR |
| Capacity (veh/h) | 1592 | - | - | 909 | 876 | 1620 | - | - |
| HCM Lane V/C Ratio | 0.006 | - | - | 0.034 | 0.022 | 0.001 | - | - |
| HCM Control Delay (s) | 7.3 | 0 | - | 9.1 | 9.2 | 7.2 | 0 | - |
| HCM Lane LOS | A | A | - | A | A | A | A | - |
| HCM 95th %tile Q(veh) | 0 | - | - | 0.1 | 0.1 | 0 | - | - |

HCM 6th TWSC
 5: Old Cornelia Hwy & Noah Martin Rd

05/13/2022

| Intersection | | | | | | |
|--------------------------|------|------|------|------|------|------|
| Int Delay, s/veh | 0.4 | | | | | |
| Movement | EBL | EBT | WBT | WBR | SBL | SBR |
| Lane Configurations | | ← | ← | | ← | |
| Traffic Vol, veh/h | 11 | 316 | 130 | 7 | 6 | 3 |
| Future Vol, veh/h | 11 | 316 | 130 | 7 | 6 | 3 |
| Conflicting Peds, #/hr | 0 | 0 | 0 | 0 | 0 | 0 |
| Sign Control | Free | Free | Free | Free | Stop | Stop |
| RT Channelized | - | None | - | None | - | None |
| Storage Length | - | - | - | - | 0 | - |
| Veh in Median Storage, # | - | 0 | 0 | - | 0 | - |
| Grade, % | - | 0 | 0 | - | 0 | - |
| Peak Hour Factor | 87 | 87 | 87 | 87 | 87 | 87 |
| Heavy Vehicles, % | 2 | 2 | 5 | 5 | 0 | 0 |
| Mvmt Flow | 13 | 363 | 149 | 8 | 7 | 3 |

| Major/Minor | Major1 | Major2 | Minor2 | | |
|----------------------|--------|--------|--------|-----|-----|
| Conflicting Flow All | 157 | 0 | 0 | 542 | 153 |
| Stage 1 | - | - | - | 153 | - |
| Stage 2 | - | - | - | 389 | - |
| Critical Hdwy | 4.12 | - | - | 6.4 | 6.2 |
| Critical Hdwy Stg 1 | - | - | - | 5.4 | - |
| Critical Hdwy Stg 2 | - | - | - | 5.4 | - |
| Follow-up Hdwy | 2.218 | - | - | 3.5 | 3.3 |
| Pot Cap-1 Maneuver | 1423 | - | - | 505 | 898 |
| Stage 1 | - | - | - | 880 | - |
| Stage 2 | - | - | - | 689 | - |
| Platoon blocked, % | - | - | - | - | - |
| Mov Cap-1 Maneuver | 1423 | - | - | 499 | 898 |
| Mov Cap-2 Maneuver | - | - | - | 499 | - |
| Stage 1 | - | - | - | 870 | - |
| Stage 2 | - | - | - | 689 | - |

HCM 6th TWSC

5: Old Cornelia Hwy & Noah Martin Rd

05/13/2022

| Approach | EB | WB | SB | | | |
|-----------------------|-------|-----|------|-----|-------|--|
| HCM Control Delay, s | 0.3 | 0 | 11.3 | | | |
| HCM LOS | | | | B | | |
| | | | | | | |
| Minor Lane/Major Mvmt | EBL | EBT | WBT | WBR | SBLn1 | |
| Capacity (veh/h) | 1423 | - | - | - | 586 | |
| HCM Lane V/C Ratio | 0.009 | - | - | - | 0.018 | |
| HCM Control Delay (s) | 7.6 | 0 | - | - | 11.3 | |
| HCM Lane LOS | A | A | - | - | B | |
| HCM 95th %tile Q(veh) | 0 | - | - | - | 0.1 | |

HCM 6th TWSC
6: US 23/Cornelia Hwy & Cagle Rd

05/13/2022

| Intersection | | | | | | | | | | | | |
|--------------------------|------|------|------|------|------|------|------|------|------|------|------|------|
| Int Delay, s/veh | 13 | | | | | | | | | | | |
| Movement | EBL | EBT | EBR | WBL | WBT | WBR | NBL | NBT | NBR | SBL | SBT | SBR |
| Lane Configurations | | ↕ | | | ↕ | | ↕ | ↑↑ | ↕ | ↑↑ | ↕ | ↑↑ |
| Traffic Vol, veh/h | 6 | 1 | 4 | 13 | 0 | 4 | 2 | 2463 | 25 | 1 | 1036 | 4 |
| Future Vol, veh/h | 6 | 1 | 4 | 13 | 0 | 4 | 2 | 2463 | 25 | 1 | 1036 | 4 |
| Conflicting Peds, #/hr | 0 | 0 | 0 | 0 | 0 | 0 | 0 | 0 | 0 | 0 | 0 | 0 |
| Sign Control | Stop | Stop | Stop | Stop | Stop | Stop | Free | Free | Free | Free | Free | Free |
| RT Channelized | - | - | None | - | - | None | - | - | None | - | - | None |
| Storage Length | - | - | - | - | - | - | 315 | - | 280 | 517 | - | - |
| Veh in Median Storage, # | - | 0 | - | - | 0 | - | - | 0 | - | - | 0 | - |
| Grade, % | - | 0 | - | - | 0 | - | - | 0 | - | - | 0 | - |
| Peak Hour Factor | 96 | 96 | 96 | 96 | 96 | 96 | 96 | 96 | 96 | 96 | 96 | 96 |
| Heavy Vehicles, % | 0 | 0 | 0 | 0 | 0 | 0 | 4 | 4 | 4 | 8 | 8 | 8 |
| Mvmt Flow | 6 | 1 | 4 | 14 | 0 | 4 | 2 | 2566 | 26 | 1 | 1079 | 4 |

| Major/Minor | Minor2 | | Minor1 | | Major1 | | Major2 | | | | | |
|----------------------|--------|------|--------|------|--------|------|--------|---|---|------|---|---|
| Conflicting Flow All | 2368 | 3677 | 540 | 3112 | 3655 | 1283 | 1083 | 0 | 0 | 2592 | 0 | 0 |
| Stage 1 | 1081 | 1081 | - | 2570 | 2570 | - | - | - | - | - | - | - |
| Stage 2 | 1287 | 2596 | - | 542 | 1085 | - | - | - | - | - | - | - |
| Critical Hdwy | 7.5 | 6.5 | 6.9 | 7.5 | 6.5 | 6.9 | 4.18 | - | - | 4.26 | - | - |
| Critical Hdwy Stg 1 | 6.5 | 5.5 | - | 6.5 | 5.5 | - | - | - | - | - | - | - |
| Critical Hdwy Stg 2 | 6.5 | 5.5 | - | 6.5 | 5.5 | - | - | - | - | - | - | - |
| Follow-up Hdwy | 3.5 | 4 | 3.3 | 3.5 | 4 | 3.3 | 2.24 | - | - | 2.28 | - | - |
| Pot Cap-1 Maneuver | 19 | 5 | 491 | ~ 5 | 5 | 159 | 628 | - | - | 150 | - | - |
| Stage 1 | 236 | 296 | - | 27 | 54 | - | - | - | - | - | - | - |
| Stage 2 | 177 | 52 | - | 497 | 295 | - | - | - | - | - | - | - |
| Platoon blocked, % | | | | | | | | | | | | |
| Mov Cap-1 Maneuver | 18 | 5 | 491 | ~ 4 | 5 | 159 | 628 | - | - | 150 | - | - |
| Mov Cap-2 Maneuver | 18 | 5 | - | ~ 4 | 5 | - | - | - | - | - | - | - |
| Stage 1 | 235 | 294 | - | 27 | 54 | - | - | - | - | - | - | - |
| Stage 2 | 172 | 52 | - | 488 | 293 | - | - | - | - | - | - | - |

HCM 6th TWSC
6: US 23/Cornelia Hwy & Cagle Rd

05/13/2022

| Approach | EB | WB | | NB | | SB | | |
|-----------------------|----------|-----------|-----|----------|-----------|-------|-----|-----|
| HCM Control Delay, s | \$ 324.8 | \$ 2511.2 | | 0 | | 0 | | |
| HCM LOS | F | F | | | | | | |
| | | | | | | | | |
| Minor Lane/Major Mvmt | NBL | NBT | NBR | EBLn1 | WBLn1 | SBL | SBT | SBR |
| Capacity (veh/h) | 628 | - | - | 20 | 5 | 150 | - | - |
| HCM Lane V/C Ratio | 0.003 | - | - | 0.573 | 3.542 | 0.007 | - | - |
| HCM Control Delay (s) | 10.8 | - | - | \$ 324.8 | \$ 2511.2 | 29.2 | - | - |
| HCM Lane LOS | B | - | - | F | F | D | - | - |
| HCM 95th %tile Q(veh) | 0 | - | - | 1.6 | 3.5 | 0 | - | - |

Notes

~: Volume exceeds capacity \$: Delay exceeds 300s +: Computation Not Defined *: All major volume in platoon

HCM Unsignalized Intersection Capacity Analysis
 1: US 23/Cornelia Hwy & Americold Logistics Driveway

2023 AM Peak Hour
 2023 AM Peak Hour No-Build Conditions



| Movement | EBL | EBR | NBL | NBT | SBU | SBT | SBR | |
|-----------------------------------|-------------|-------------|-------------|----------------------|-------------|-------------|-------------|-------------|
| Lane Configurations | | | | | | | | |
| Traffic Volume (veh/h) | 6 | 19 | 59 | 892 | 1 | 2237 | 34 | |
| Future Volume (Veh/h) | 6 | 19 | 59 | 892 | 1 | 2237 | 34 | |
| Sign Control | Stop | | | Free | | Free | | |
| Grade | 0% | | | 0% | | 0% | | |
| Peak Hour Factor | 0.86 | 0.86 | 0.86 | 0.86 | 0.86 | 0.86 | 0.86 | |
| Hourly flow rate (vph) | 7 | 22 | 69 | 1037 | 0 | 2601 | 40 | |
| Pedestrians | | | | | | | | |
| Lane Width (ft) | | | | | | | | |
| Walking Speed (ft/s) | | | | | | | | |
| Percent Blockage | | | | | | | | |
| Right turn flare (veh) | | | | | | | | |
| Median type | | | | None | None | | | |
| Median storage (veh) | | | | | | | | |
| Upstream signal (ft) | | | | | | | | |
| pX, platoon unblocked | | | | | 0.00 | | | |
| vC, conflicting volume | 3258 | 1300 | 2641 | 0 | | | | |
| vC1, stage 1 conf vol | | | | | | | | |
| vC2, stage 2 conf vol | | | | | | | | |
| vCu, unblocked vol | 3258 | 1300 | 2641 | 0 | | | | |
| tC, single (s) | 7.1 | 7.2 | 4.3 | 0.0 | | | | |
| tC, 2 stage (s) | | | | | | | | |
| tF (s) | 3.7 | 3.5 | 2.3 | 0.0 | | | | |
| p0 queue free % | 0 | 83 | 49 | 0 | | | | |
| cM capacity (veh/h) | 3 | 133 | 136 | 0 | | | | |
| Direction, Lane # | EB 1 | NB 1 | NB 2 | NB 3 | SB 1 | SB 2 | SB 3 | SB 4 |
| Volume Total | 29 | 69 | 518 | 518 | 1300 | 1300 | 40 | 0 |
| Volume Left | 7 | 69 | 0 | 0 | 0 | 0 | 0 | 0 |
| Volume Right | 22 | 0 | 0 | 0 | 0 | 0 | 40 | 0 |
| cSH | 10 | 136 | 1700 | 1700 | 1700 | 1700 | 1700 | 1700 |
| Volume to Capacity | 2.85 | 0.51 | 0.30 | 0.30 | 0.77 | 0.77 | 0.02 | 0.00 |
| Queue Length 95th (ft) | 117 | 60 | 0 | 0 | 0 | 0 | 0 | 0 |
| Control Delay (s) | 1569.6 | 56.0 | 0.0 | 0.0 | 0.0 | 0.0 | 0.0 | 0.0 |
| Lane LOS | F | F | | | | | | |
| Approach Delay (s) | 1569.6 | 3.5 | 0.0 | | | | | |
| Approach LOS | F | | | | | | | |
| Intersection Summary | | | | | | | | |
| Average Delay | | | 13.1 | | | | | |
| Intersection Capacity Utilization | | | 71.8% | ICU Level of Service | C | | | |
| Analysis Period (min) | | | 15 | | | | | |

HCM Unsignalized Intersection Capacity Analysis
 3: Cagle Mill Rd & Julian Baugh Rd

2023 AM Peak Hour
 2023 AM Peak Hour No-Build Conditions

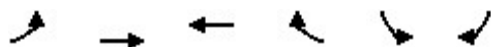

| Movement | EBL | EBT | WBT | WBR | SBL | SBR |
|-----------------------------------|------|------|------|----------------------|------|------|
| Lane Configurations | | | | | | |
| Traffic Volume (veh/h) | 4 | 0 | 1 | 11 | 5 | 3 |
| Future Volume (Veh/h) | 4 | 0 | 1 | 11 | 5 | 3 |
| Sign Control | | Stop | Stop | | Free | |
| Grade | | 0% | 0% | | 0% | |
| Peak Hour Factor | 0.72 | 0.72 | 0.72 | 0.72 | 0.72 | 0.72 |
| Hourly flow rate (vph) | 6 | 0 | 1 | 15 | 7 | 4 |
| Pedestrians | | | | | | |
| Lane Width (ft) | | | | | | |
| Walking Speed (ft/s) | | | | | | |
| Percent Blockage | | | | | | |
| Right turn flare (veh) | | | | | | |
| Median type | | | | | | |
| None | | | | | | |
| Median storage (veh) | | | | | | |
| Upstream signal (ft) | | | | | | |
| pX, platoon unblocked | | | | | | |
| vC, conflicting volume | 30 | 14 | 18 | 0 | 0 | |
| vC1, stage 1 conf vol | | | | | | |
| vC2, stage 2 conf vol | | | | | | |
| vCu, unblocked vol | 30 | 14 | 18 | 0 | 0 | |
| tC, single (s) | 7.1 | 6.5 | 6.5 | 6.2 | 4.1 | |
| tC, 2 stage (s) | | | | | | |
| tF (s) | 3.5 | 4.0 | 4.0 | 3.3 | 2.2 | |
| p0 queue free % | 99 | 100 | 100 | 99 | 100 | |
| cM capacity (veh/h) | 967 | 881 | 876 | 1091 | 1636 | |
| Direction, Lane # | EB 1 | WB 1 | SB 1 | | | |
| Volume Total | 6 | 16 | 11 | | | |
| Volume Left | 6 | 0 | 7 | | | |
| Volume Right | 0 | 15 | 4 | | | |
| cSH | 967 | 1074 | 1636 | | | |
| Volume to Capacity | 0.01 | 0.01 | 0.00 | | | |
| Queue Length 95th (ft) | 0 | 1 | 0 | | | |
| Control Delay (s) | 8.7 | 8.4 | 4.6 | | | |
| Lane LOS | A | A | A | | | |
| Approach Delay (s) | 8.7 | 8.4 | 4.6 | | | |
| Approach LOS | A | A | | | | |
| Intersection Summary | | | | | | |
| Average Delay | | | 7.2 | | | |
| Intersection Capacity Utilization | | | Err% | ICU Level of Service | | H |
| Analysis Period (min) | | | 15 | | | |

| Intersection | | | | | | |
|--------------------------|------|------|------|------|------|------|
| Int Delay, s/veh | 4.4 | | | | | |
| Movement | EBT | EBR | WBL | WBT | NBL | NBR |
| Lane Configurations | ↔ | | | ↔ | | ↔ |
| Traffic Vol, veh/h | 3 | 6 | 2 | 7 | 14 | 1 |
| Future Vol, veh/h | 3 | 6 | 2 | 7 | 14 | 1 |
| Conflicting Peds, #/hr | 0 | 0 | 0 | 0 | 0 | 0 |
| Sign Control | Free | Free | Free | Free | Stop | Stop |
| RT Channelized | - | None | - | None | - | None |
| Storage Length | - | - | - | - | 0 | - |
| Veh in Median Storage, # | 0 | - | - | 0 | 0 | - |
| Grade, % | 0 | - | - | 0 | 0 | - |
| Peak Hour Factor | 62 | 62 | 62 | 62 | 62 | 62 |
| Heavy Vehicles, % | 0 | 0 | 0 | 0 | 0 | 0 |
| Mvmt Flow | 5 | 10 | 3 | 11 | 23 | 2 |

| Major/Minor | Major1 | Major2 | Minor1 | Minor2 | Minor3 |
|----------------------|--------|--------|--------|--------|--------|
| Conflicting Flow All | 0 | 0 | 15 | 0 | 27 |
| Stage 1 | - | - | - | - | 10 |
| Stage 2 | - | - | - | - | 17 |
| Critical Hdwy | - | - | 4.1 | - | 6.4 |
| Critical Hdwy Stg 1 | - | - | - | - | 5.4 |
| Critical Hdwy Stg 2 | - | - | - | - | 5.4 |
| Follow-up Hdwy | - | - | 2.2 | - | 3.5 |
| Pot Cap-1 Maneuver | - | - | 1616 | - | 993 |
| Stage 1 | - | - | - | - | 1018 |
| Stage 2 | - | - | - | - | 1011 |
| Platoon blocked, % | - | - | - | - | - |
| Mov Cap-1 Maneuver | - | - | 1616 | - | 991 |
| Mov Cap-2 Maneuver | - | - | - | - | 991 |
| Stage 1 | - | - | - | - | 1018 |
| Stage 2 | - | - | - | - | 1009 |

| Approach | EB | WB | NB |
|----------------------|----|-----|-----|
| HCM Control Delay, s | 0 | 1.6 | 8.7 |
| HCM LOS | | | A |

| Minor Lane/Major Mvmt | NBLn1 | EBT | EBR | WBL | WBT |
|-----------------------|-------|-----|-----|-------|-----|
| Capacity (veh/h) | 996 | - | - | 1616 | - |
| HCM Lane V/C Ratio | 0.024 | - | - | 0.002 | - |
| HCM Control Delay (s) | 8.7 | - | - | 7.2 | 0 |
| HCM Lane LOS | A | - | - | A | A |
| HCM 95th %tile Q(veh) | 0.1 | - | - | 0 | - |

| Intersection | | | | | | | | | | | | |
|--------------------------|------|------|------|------|------|------|------|------|------|------|------|------|
| Int Delay, s/veh | 6.5 | | | | | | | | | | | |
| Movement | EBL | EBT | EBR | WBL | WBT | WBR | NBL | NBT | NBR | SBL | SBT | SBR |
| Lane Configurations | | ↕ | | | ↕ | | | ↕ | | | ↕ | |
| Traffic Vol, veh/h | 1 | 4 | 2 | 0 | 17 | 2 | 1 | 1 | 1 | 1 | 7 | 2 |
| Future Vol, veh/h | 1 | 4 | 2 | 0 | 17 | 2 | 1 | 1 | 1 | 1 | 7 | 2 |
| Conflicting Peds, #/hr | 0 | 0 | 0 | 0 | 0 | 0 | 0 | 0 | 0 | 0 | 0 | 0 |
| Sign Control | Stop | Stop | Stop | Stop | Stop | Stop | Free | Free | Free | Free | Free | Free |
| RT Channelized | - | - | None | - | - | None | - | - | None | - | - | None |
| Storage Length | - | - | - | - | - | - | - | - | - | - | - | - |
| Veh in Median Storage, # | - | 0 | - | - | 0 | - | - | 0 | - | - | 0 | - |
| Grade, % | - | 0 | - | - | 0 | - | - | 0 | - | - | 0 | - |
| Peak Hour Factor | 79 | 79 | 79 | 79 | 79 | 79 | 79 | 79 | 79 | 79 | 79 | 79 |
| Heavy Vehicles, % | 14 | 14 | 14 | 6 | 6 | 6 | 33 | 33 | 33 | 10 | 10 | 10 |
| Mvmt Flow | 1 | 5 | 3 | 0 | 22 | 3 | 1 | 1 | 1 | 1 | 9 | 3 |

| Major/Minor | Minor2 | | Minor1 | | Major1 | | | Major2 | | | | |
|----------------------|--------|-------|--------|-------|--------|-------|-------|--------|---|------|---|---|
| Conflicting Flow All | 29 | 17 | 11 | 21 | 18 | 2 | 12 | 0 | 0 | 2 | 0 | 0 |
| Stage 1 | 13 | 13 | - | 4 | 4 | - | - | - | - | - | - | - |
| Stage 2 | 16 | 4 | - | 17 | 14 | - | - | - | - | - | - | - |
| Critical Hdwy | 7.24 | 6.64 | 6.34 | 7.16 | 6.56 | 6.26 | 4.43 | - | - | 4.2 | - | - |
| Critical Hdwy Stg 1 | 6.24 | 5.64 | - | 6.16 | 5.56 | - | - | - | - | - | - | - |
| Critical Hdwy Stg 2 | 6.24 | 5.64 | - | 6.16 | 5.56 | - | - | - | - | - | - | - |
| Follow-up Hdwy | 3.626 | 4.126 | 3.426 | 3.554 | 4.054 | 3.354 | 2.497 | - | - | 2.29 | - | - |
| Pot Cap-1 Maneuver | 950 | 854 | 1036 | 982 | 868 | 1071 | 1427 | - | - | 1569 | - | - |
| Stage 1 | 977 | 861 | - | 1008 | 885 | - | - | - | - | - | - | - |
| Stage 2 | 973 | 869 | - | 992 | 876 | - | - | - | - | - | - | - |
| Platoon blocked, % | | | | | | | | - | - | - | - | - |
| Mov Cap-1 Maneuver | 928 | 852 | 1036 | 974 | 866 | 1071 | 1427 | - | - | 1569 | - | - |
| Mov Cap-2 Maneuver | 928 | 852 | - | 974 | 866 | - | - | - | - | - | - | - |
| Stage 1 | 976 | 860 | - | 1007 | 884 | - | - | - | - | - | - | - |
| Stage 2 | 946 | 868 | - | 983 | 875 | - | - | - | - | - | - | - |

| Approach | EB | | WB | | NB | | SB | |
|----------------------|----|--|-----|--|-----|--|-----|--|
| HCM Control Delay, s | 9 | | 9.2 | | 2.5 | | 0.7 | |
| HCM LOS | A | | A | | | | | |

| Minor Lane/Major Mvmt | NBL | NBT | NBR | EBLn1 | WBLn1 | SBL | SBT | SBR |
|-----------------------|-------|-----|-----|-------|-------|-------|-----|-----|
| Capacity (veh/h) | 1427 | - | - | 909 | 884 | 1569 | - | - |
| HCM Lane V/C Ratio | 0.001 | - | - | 0.01 | 0.027 | 0.001 | - | - |
| HCM Control Delay (s) | 7.5 | 0 | - | 9 | 9.2 | 7.3 | 0 | - |
| HCM Lane LOS | A | A | - | A | A | A | A | - |
| HCM 95th %tile Q(veh) | 0 | - | - | 0 | 0.1 | 0 | - | - |

| Intersection | | | | | | |
|--------------------------|------|------|------|------|------|------|
| Int Delay, s/veh | 0.2 | | | | | |
| Movement | EBL | EBT | WBT | WBR | SBL | SBR |
| Lane Configurations | | ↶ | ↷ | | ↶ | |
| Traffic Vol, veh/h | 0 | 85 | 385 | 2 | 1 | 7 |
| Future Vol, veh/h | 0 | 85 | 385 | 2 | 1 | 7 |
| Conflicting Peds, #/hr | 0 | 0 | 0 | 0 | 0 | 0 |
| Sign Control | Free | Free | Free | Free | Stop | Stop |
| RT Channelized | - | None | - | None | - | None |
| Storage Length | - | - | - | - | 0 | - |
| Veh in Median Storage, # | - | 0 | 0 | - | 0 | - |
| Grade, % | - | 0 | 0 | - | 0 | - |
| Peak Hour Factor | 89 | 89 | 89 | 89 | 89 | 89 |
| Heavy Vehicles, % | 9 | 9 | 3 | 3 | 13 | 13 |
| Mvmt Flow | 0 | 96 | 433 | 2 | 1 | 8 |

| Major/Minor | Major1 | Major2 | Minor2 | | |
|----------------------|--------|--------|--------|---|-------|
| Conflicting Flow All | 435 | 0 | - | 0 | 530 |
| Stage 1 | - | - | - | - | 434 |
| Stage 2 | - | - | - | - | 96 |
| Critical Hdwy | 4.19 | - | - | - | 6.53 |
| Critical Hdwy Stg 1 | - | - | - | - | 5.53 |
| Critical Hdwy Stg 2 | - | - | - | - | 5.53 |
| Follow-up Hdwy | 2.281 | - | - | - | 3.617 |
| Pot Cap-1 Maneuver | 1088 | - | - | - | 491 |
| Stage 1 | - | - | - | - | 630 |
| Stage 2 | - | - | - | - | 901 |
| Platoon blocked, % | | - | - | - | |
| Mov Cap-1 Maneuver | 1088 | - | - | - | 491 |
| Mov Cap-2 Maneuver | - | - | - | - | 491 |
| Stage 1 | - | - | - | - | 630 |
| Stage 2 | - | - | - | - | 901 |

| Approach | EB | WB | SB |
|----------------------|----|----|------|
| HCM Control Delay, s | 0 | 0 | 11.3 |
| HCM LOS | | | B |

| Minor Lane/Major Mvmt | EBL | EBT | WBT | WBR | SBLn1 |
|-----------------------|------|-----|-----|-----|-------|
| Capacity (veh/h) | 1088 | - | - | - | 583 |
| HCM Lane V/C Ratio | - | - | - | - | 0.015 |
| HCM Control Delay (s) | 0 | - | - | - | 11.3 |
| HCM Lane LOS | A | - | - | - | B |
| HCM 95th %tile Q(veh) | 0 | - | - | - | 0 |

| Intersection | | | | | | | | | | | | |
|--------------------------|------|------|------|------|------|------|------|------|------|------|------|------|
| Int Delay, s/veh | 12.6 | | | | | | | | | | | |
| Movement | EBL | EBT | EBR | WBL | WBT | WBR | NBL | NBT | NBR | SBL | SBT | SBR |
| Lane Configurations | | ↕ | | | ↕ | | ↕ | ↑↑ | ↕ | ↕ | ↑↑ | ↕ |
| Traffic Vol, veh/h | 2 | 0 | 1 | 23 | 2 | 1 | 0 | 803 | 0 | 0 | 2249 | 2 |
| Future Vol, veh/h | 2 | 0 | 1 | 23 | 2 | 1 | 0 | 803 | 0 | 0 | 2249 | 2 |
| Conflicting Peds, #/hr | 0 | 0 | 0 | 0 | 0 | 0 | 0 | 0 | 0 | 0 | 0 | 0 |
| Sign Control | Stop | Stop | Stop | Stop | Stop | Stop | Free | Free | Free | Free | Free | Free |
| RT Channelized | - | - | None | - | - | None | - | - | None | - | - | None |
| Storage Length | - | - | - | - | - | - | 315 | - | 280 | 517 | - | - |
| Veh in Median Storage, # | - | 0 | - | - | 0 | - | - | 0 | - | - | 0 | - |
| Grade, % | - | 0 | - | - | 0 | - | - | 0 | - | - | 0 | - |
| Peak Hour Factor | 85 | 85 | 85 | 85 | 85 | 85 | 85 | 85 | 85 | 85 | 85 | 85 |
| Heavy Vehicles, % | 50 | 50 | 50 | 0 | 0 | 0 | 11 | 11 | 11 | 4 | 4 | 4 |
| Mvmt Flow | 2 | 0 | 1 | 27 | 2 | 1 | 0 | 945 | 0 | 0 | 2646 | 2 |

| Major/Minor | Minor2 | | Minor1 | | Major1 | | | Major2 | | | | |
|----------------------|--------|------|--------|------|--------|-----|------|--------|---|------|---|---|
| Conflicting Flow All | 3120 | 3591 | 1323 | 2268 | 3593 | 473 | 2648 | 0 | 0 | 945 | 0 | 0 |
| Stage 1 | 2646 | 2646 | - | 945 | 945 | - | - | - | - | - | - | - |
| Stage 2 | 474 | 945 | - | 1323 | 2648 | - | - | - | - | - | - | - |
| Critical Hdwy | 8.5 | 7.5 | 7.9 | 7.5 | 6.5 | 6.9 | 4.32 | - | - | 4.18 | - | - |
| Critical Hdwy Stg 1 | 7.5 | 6.5 | - | 6.5 | 5.5 | - | - | - | - | - | - | - |
| Critical Hdwy Stg 2 | 7.5 | 6.5 | - | 6.5 | 5.5 | - | - | - | - | - | - | - |
| Follow-up Hdwy | 4 | 4.5 | 3.8 | 3.5 | 4 | 3.3 | 2.31 | - | - | 2.24 | - | - |
| Pot Cap-1 Maneuver | ~2 | 2 | 96 | ~23 | 6 | 543 | 135 | - | - | 710 | - | - |
| Stage 1 | 11 | 23 | - | 285 | 343 | - | - | - | - | - | - | - |
| Stage 2 | 431 | 248 | - | 168 | 49 | - | - | - | - | - | - | - |
| Platoon blocked, % | | | | | | | | - | - | - | - | - |
| Mov Cap-1 Maneuver | ~1 | 2 | 96 | ~23 | 6 | 543 | 135 | - | - | 710 | - | - |
| Mov Cap-2 Maneuver | ~1 | 2 | - | ~23 | 6 | - | - | - | - | - | - | - |
| Stage 1 | 11 | 23 | - | 285 | 343 | - | - | - | - | - | - | - |
| Stage 2 | 427 | 248 | - | 166 | 49 | - | - | - | - | - | - | - |

| Approach | EB | | WB | | NB | | | SB | | |
|-----------------------|--------|--|-------|--|----|--|--|----|--|--|
| HCM Control Delay, \$ | 6632.1 | | 726.8 | | 0 | | | 0 | | |
| HCM LOS | F | | F | | | | | | | |

| Minor Lane/Major Mvmt | NBL | NBT | NBR | EBLn1 | WBLn1 | SBL | SBT | SBR |
|-----------------------|-----|-----|-----|-----------|----------|-----|-----|-----|
| Capacity (veh/h) | 135 | - | - | 1 | 19 | 710 | - | - |
| HCM Lane V/C Ratio | - | - | - | 3.529 | 1.61 | - | - | - |
| HCM Control Delay (s) | 0 | - | - | \$ 6632.1 | \$ 726.8 | 0 | - | - |
| HCM Lane LOS | A | - | - | F | F | A | - | - |
| HCM 95th %tile Q(veh) | 0 | - | - | 1.3 | 4.2 | 0 | - | - |

Notes
 ~: Volume exceeds capacity \$: Delay exceeds 300s +: Computation Not Defined *: All major volume in platoon

HCM Unsignalized Intersection Capacity Analysis
 1: US 23/Cornelia Hwy & Americold Logistics Driveway

2023 PM Peak Hour
 2023 PM Peak Hour No-Build Conditions



| Movement | EBL | EBR | NBL | NBT | SBU | SBT | SBR | |
|-----------------------------------|-------------|-------------|-------------|----------------------|-------------|-------------|-------------|-------------|
| Lane Configurations | | | | | | | | |
| Traffic Volume (veh/h) | 20 | 26 | 6 | 2555 | 2 | 1069 | 8 | |
| Future Volume (Veh/h) | 20 | 26 | 6 | 2555 | 2 | 1069 | 8 | |
| Sign Control | Stop | | | Free | | Free | | |
| Grade | 0% | | | 0% | | 0% | | |
| Peak Hour Factor | 0.95 | 0.95 | 0.95 | 0.95 | 0.95 | 0.95 | 0.95 | |
| Hourly flow rate (vph) | 21 | 27 | 6 | 2689 | 0 | 1125 | 8 | |
| Pedestrians | | | | | | | | |
| Lane Width (ft) | | | | | | | | |
| Walking Speed (ft/s) | | | | | | | | |
| Percent Blockage | | | | | | | | |
| Right turn flare (veh) | | | | | | | | |
| Median type | | | | None | None | | | |
| Median storage (veh) | | | | | | | | |
| Upstream signal (ft) | | | | | | | | |
| pX, platoon unblocked | | | | | 0.00 | | | |
| vC, conflicting volume | 2482 | 562 | 1133 | 0 | | | | |
| vC1, stage 1 conf vol | | | | | | | | |
| vC2, stage 2 conf vol | | | | | | | | |
| vCu, unblocked vol | 2482 | 562 | 1133 | 0 | | | | |
| tC, single (s) | 7.2 | 7.3 | 4.2 | 0.0 | | | | |
| tC, 2 stage (s) | | | | | | | | |
| tF (s) | 3.7 | 3.5 | 2.2 | 0.0 | | | | |
| p0 queue free % | 0 | 94 | 99 | 0 | | | | |
| cM capacity (veh/h) | 19 | 429 | 601 | 0 | | | | |
| Direction, Lane # | EB 1 | NB 1 | NB 2 | NB 3 | SB 1 | SB 2 | SB 3 | SB 4 |
| Volume Total | 48 | 6 | 1344 | 1344 | 562 | 562 | 8 | 0 |
| Volume Left | 21 | 6 | 0 | 0 | 0 | 0 | 0 | 0 |
| Volume Right | 27 | 0 | 0 | 0 | 0 | 0 | 8 | 0 |
| cSH | 41 | 601 | 1700 | 1700 | 1700 | 1700 | 1700 | 1700 |
| Volume to Capacity | 1.17 | 0.01 | 0.79 | 0.79 | 0.33 | 0.33 | 0.00 | 0.00 |
| Queue Length 95th (ft) | 118 | 1 | 0 | 0 | 0 | 0 | 0 | 0 |
| Control Delay (s) | 351.4 | 11.1 | 0.0 | 0.0 | 0.0 | 0.0 | 0.0 | 0.0 |
| Lane LOS | F | B | | | | | | |
| Approach Delay (s) | 351.4 | 0.0 | 0.0 | | | | | |
| Approach LOS | F | | | | | | | |
| Intersection Summary | | | | | | | | |
| Average Delay | | | 4.4 | | | | | |
| Intersection Capacity Utilization | | | 80.6% | ICU Level of Service | | D | | |
| Analysis Period (min) | | | 15 | | | | | |

HCM Unsignalized Intersection Capacity Analysis
 3: Cagle Mill Rd & Julian Baugh Rd

2023 PM Peak Hour
 2023 PM Peak Hour No-Build Conditions

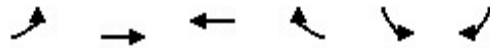

| Movement | EBL | EBT | WBT | WBR | SBL | SBR |
|-----------------------------------|-------------|-------------|-------------|----------------------|------|------|
| Lane Configurations | ↶ | | ↶ | | | ↶ |
| Traffic Volume (veh/h) | 2 | 0 | 1 | 11 | 23 | 2 |
| Future Volume (Veh/h) | 2 | 0 | 1 | 11 | 23 | 2 |
| Sign Control | | Stop | Stop | | Free | |
| Grade | | 0% | 0% | | 0% | |
| Peak Hour Factor | 0.75 | 0.75 | 0.75 | 0.75 | 0.75 | 0.75 |
| Hourly flow rate (vph) | 3 | 0 | 1 | 15 | 31 | 3 |
| Pedestrians | | | | | | |
| Lane Width (ft) | | | | | | |
| Walking Speed (ft/s) | | | | | | |
| Percent Blockage | | | | | | |
| Right turn flare (veh) | | | | | | |
| Median type | None | | | | | |
| Median storage (veh) | | | | | | |
| Upstream signal (ft) | | | | | | |
| pX, platoon unblocked | | | | | | |
| vC, conflicting volume | 78 | 62 | 65 | 0 | 0 | |
| vC1, stage 1 conf vol | | | | | | |
| vC2, stage 2 conf vol | | | | | | |
| vCu, unblocked vol | 78 | 62 | 65 | 0 | 0 | |
| tC, single (s) | 7.1 | 6.5 | 6.5 | 6.2 | 4.1 | |
| tC, 2 stage (s) | | | | | | |
| tF (s) | 3.5 | 4.0 | 4.0 | 3.3 | 2.2 | |
| p0 queue free % | 100 | 100 | 100 | 99 | 98 | |
| cM capacity (veh/h) | 890 | 817 | 814 | 1091 | 1636 | |
| Direction, Lane # | EB 1 | WB 1 | SB 1 | | | |
| Volume Total | 3 | 16 | 34 | | | |
| Volume Left | 3 | 0 | 31 | | | |
| Volume Right | 0 | 15 | 3 | | | |
| cSH | 890 | 1068 | 1636 | | | |
| Volume to Capacity | 0.00 | 0.01 | 0.02 | | | |
| Queue Length 95th (ft) | 0 | 1 | 1 | | | |
| Control Delay (s) | 9.1 | 8.4 | 6.6 | | | |
| Lane LOS | A | A | A | | | |
| Approach Delay (s) | 9.1 | 8.4 | 6.6 | | | |
| Approach LOS | A | A | | | | |
| Intersection Summary | | | | | | |
| Average Delay | | | 7.3 | | | |
| Intersection Capacity Utilization | | | Err% | ICU Level of Service | H | |
| Analysis Period (min) | | | 15 | | | |

| Intersection | | | | | | |
|--------------------------|------|------|------|------|------|------|
| Int Delay, s/veh | 2.7 | | | | | |
| Movement | EBT | EBR | WBL | WBT | NBL | NBR |
| Lane Configurations | | | | | | |
| Traffic Vol, veh/h | 17 | 15 | 2 | 6 | 11 | 5 |
| Future Vol, veh/h | 17 | 15 | 2 | 6 | 11 | 5 |
| Conflicting Peds, #/hr | 0 | 0 | 0 | 0 | 0 | 0 |
| Sign Control | Free | Free | Free | Free | Stop | Stop |
| RT Channelized | - | None | - | None | - | None |
| Storage Length | - | - | - | - | 0 | - |
| Veh in Median Storage, # | 0 | - | - | 0 | 0 | - |
| Grade, % | 0 | - | - | 0 | 0 | - |
| Peak Hour Factor | 87 | 87 | 87 | 87 | 87 | 87 |
| Heavy Vehicles, % | 0 | 0 | 0 | 0 | 0 | 0 |
| Mvmt Flow | 20 | 17 | 2 | 7 | 13 | 6 |

| Major/Minor | Major1 | Major2 | Minor1 | | |
|----------------------|--------|--------|--------|---|------|
| Conflicting Flow All | 0 | 0 | 37 | 0 | 40 |
| Stage 1 | - | - | - | - | 29 |
| Stage 2 | - | - | - | - | 11 |
| Critical Hdwy | - | - | 4.1 | - | 6.4 |
| Critical Hdwy Stg 1 | - | - | - | - | 5.4 |
| Critical Hdwy Stg 2 | - | - | - | - | 5.4 |
| Follow-up Hdwy | - | - | 2.2 | - | 3.5 |
| Pot Cap-1 Maneuver | - | - | 1587 | - | 977 |
| Stage 1 | - | - | - | - | 999 |
| Stage 2 | - | - | - | - | 1017 |
| Platoon blocked, % | - | - | - | - | - |
| Mov Cap-1 Maneuver | - | - | 1587 | - | 976 |
| Mov Cap-2 Maneuver | - | - | - | - | 976 |
| Stage 1 | - | - | - | - | 999 |
| Stage 2 | - | - | - | - | 1016 |

| Approach | EB | WB | NB |
|----------------------|----|-----|-----|
| HCM Control Delay, s | 0 | 1.8 | 8.7 |
| HCM LOS | | | A |

| Minor Lane/Major Mvmt | NBLn1 | EBT | EBR | WBL | WBT |
|-----------------------|-------|-----|-----|-------|-----|
| Capacity (veh/h) | 999 | - | - | 1587 | - |
| HCM Lane V/C Ratio | 0.018 | - | - | 0.001 | - |
| HCM Control Delay (s) | 8.7 | - | - | 7.3 | 0 |
| HCM Lane LOS | A | - | - | A | A |
| HCM 95th %tile Q(veh) | 0.1 | - | - | 0 | - |

| Intersection | | | | | | | | | | | | |
|--------------------------|------|------|------|------|------|------|------|------|------|------|------|------|
| Int Delay, s/veh | 7 | | | | | | | | | | | |
| Movement | EBL | EBT | EBR | WBL | WBT | WBR | NBL | NBT | NBR | SBL | SBT | SBR |
| Lane Configurations | | ↕ | | | ↕ | | | ↕ | | | ↕ | |
| Traffic Vol, veh/h | 4 | 15 | 5 | 7 | 8 | 0 | 8 | 2 | 7 | 1 | 2 | 1 |
| Future Vol, veh/h | 4 | 15 | 5 | 7 | 8 | 0 | 8 | 2 | 7 | 1 | 2 | 1 |
| Conflicting Peds, #/hr | 0 | 0 | 0 | 0 | 0 | 0 | 0 | 0 | 0 | 0 | 0 | 0 |
| Sign Control | Stop | Stop | Stop | Stop | Stop | Stop | Free | Free | Free | Free | Free | Free |
| RT Channelized | - | - | None | - | - | None | - | - | None | - | - | None |
| Storage Length | - | - | - | - | - | - | - | - | - | - | - | - |
| Veh in Median Storage, # | - | 0 | - | - | 0 | - | - | 0 | - | - | 0 | - |
| Grade, % | - | 0 | - | - | 0 | - | - | 0 | - | - | 0 | - |
| Peak Hour Factor | 78 | 78 | 78 | 78 | 78 | 78 | 78 | 78 | 78 | 78 | 78 | 78 |
| Heavy Vehicles, % | 0 | 0 | 0 | 7 | 7 | 7 | 6 | 6 | 6 | 0 | 0 | 0 |
| Mvmt Flow | 5 | 19 | 6 | 9 | 10 | 0 | 10 | 3 | 9 | 1 | 3 | 1 |

| Major/Minor | Minor2 | | Minor1 | | Major1 | | | Major2 | | | | |
|----------------------|--------|-----|--------|-------|--------|-------|-------|--------|---|------|---|---|
| Conflicting Flow All | 39 | 38 | 4 | 46 | 34 | 8 | 4 | 0 | 0 | 12 | 0 | 0 |
| Stage 1 | 6 | 6 | - | 28 | 28 | - | - | - | - | - | - | - |
| Stage 2 | 33 | 32 | - | 18 | 6 | - | - | - | - | - | - | - |
| Critical Hdwy | 7.1 | 6.5 | 6.2 | 7.17 | 6.57 | 6.27 | 4.16 | - | - | 4.1 | - | - |
| Critical Hdwy Stg 1 | 6.1 | 5.5 | - | 6.17 | 5.57 | - | - | - | - | - | - | - |
| Critical Hdwy Stg 2 | 6.1 | 5.5 | - | 6.17 | 5.57 | - | - | - | - | - | - | - |
| Follow-up Hdwy | 3.5 | 4 | 3.3 | 3.563 | 4.063 | 3.363 | 2.254 | - | - | 2.2 | - | - |
| Pot Cap-1 Maneuver | 971 | 858 | 1085 | 943 | 849 | 1060 | 1592 | - | - | 1620 | - | - |
| Stage 1 | 1021 | 895 | - | 976 | 862 | - | - | - | - | - | - | - |
| Stage 2 | 988 | 872 | - | 988 | 881 | - | - | - | - | - | - | - |
| Platoon blocked, % | | | | | | | | - | - | - | - | - |
| Mov Cap-1 Maneuver | 956 | 852 | 1085 | 917 | 843 | 1060 | 1592 | - | - | 1620 | - | - |
| Mov Cap-2 Maneuver | 956 | 852 | - | 917 | 843 | - | - | - | - | - | - | - |
| Stage 1 | 1015 | 894 | - | 970 | 857 | - | - | - | - | - | - | - |
| Stage 2 | 970 | 867 | - | 960 | 880 | - | - | - | - | - | - | - |

| Approach | EB | | WB | | NB | | SB | |
|----------------------|-----|--|-----|--|-----|--|-----|--|
| HCM Control Delay, s | 9.1 | | 9.2 | | 3.4 | | 1.8 | |
| HCM LOS | A | | A | | | | | |

| Minor Lane/Major Mvmt | NBL | NBT | NBR | EBLn1 | WBLn1 | SBL | SBT | SBR |
|-----------------------|-------|-----|-----|-------|-------|-------|-----|-----|
| Capacity (veh/h) | 1592 | - | - | 909 | 876 | 1620 | - | - |
| HCM Lane V/C Ratio | 0.006 | - | - | 0.034 | 0.022 | 0.001 | - | - |
| HCM Control Delay (s) | 7.3 | 0 | - | 9.1 | 9.2 | 7.2 | 0 | - |
| HCM Lane LOS | A | A | - | A | A | A | A | - |
| HCM 95th %tile Q(veh) | 0 | - | - | 0.1 | 0.1 | 0 | - | - |

| Intersection | | | | | | |
|--------------------------|------|------|------|------|------|------|
| Int Delay, s/veh | 0.3 | | | | | |
| Movement | EBL | EBT | WBT | WBR | SBL | SBR |
| Lane Configurations | | ↶ | ↷ | | ↶ | ↷ |
| Traffic Vol, veh/h | 11 | 326 | 134 | 7 | 6 | 3 |
| Future Vol, veh/h | 11 | 326 | 134 | 7 | 6 | 3 |
| Conflicting Peds, #/hr | 0 | 0 | 0 | 0 | 0 | 0 |
| Sign Control | Free | Free | Free | Free | Stop | Stop |
| RT Channelized | - | None | - | None | - | None |
| Storage Length | - | - | - | - | 0 | - |
| Veh in Median Storage, # | - | 0 | 0 | - | 0 | - |
| Grade, % | - | 0 | 0 | - | 0 | - |
| Peak Hour Factor | 87 | 87 | 87 | 87 | 87 | 87 |
| Heavy Vehicles, % | 2 | 2 | 5 | 5 | 0 | 0 |
| Mvmt Flow | 13 | 375 | 154 | 8 | 7 | 3 |

| Major/Minor | Major1 | Major2 | Minor2 | | |
|----------------------|--------|--------|--------|---|---------|
| Conflicting Flow All | 162 | 0 | - | 0 | 559 158 |
| Stage 1 | - | - | - | - | 158 - |
| Stage 2 | - | - | - | - | 401 - |
| Critical Hdwy | 4.12 | - | - | - | 6.4 6.2 |
| Critical Hdwy Stg 1 | - | - | - | - | 5.4 - |
| Critical Hdwy Stg 2 | - | - | - | - | 5.4 - |
| Follow-up Hdwy | 2.218 | - | - | - | 3.5 3.3 |
| Pot Cap-1 Maneuver | 1417 | - | - | - | 494 893 |
| Stage 1 | - | - | - | - | 875 - |
| Stage 2 | - | - | - | - | 681 - |
| Platoon blocked, % | | - | - | - | |
| Mov Cap-1 Maneuver | 1417 | - | - | - | 488 893 |
| Mov Cap-2 Maneuver | - | - | - | - | 488 - |
| Stage 1 | - | - | - | - | 865 - |
| Stage 2 | - | - | - | - | 681 - |

| Approach | EB | WB | SB |
|----------------------|-----|----|------|
| HCM Control Delay, s | 0.2 | 0 | 11.4 |
| HCM LOS | | | B |

| Minor Lane/Major Mvmt | EBL | EBT | WBT | WBR | SBLn1 |
|-----------------------|-------|-----|-----|-----|-------|
| Capacity (veh/h) | 1417 | - | - | - | 575 |
| HCM Lane V/C Ratio | 0.009 | - | - | - | 0.018 |
| HCM Control Delay (s) | 7.6 | 0 | - | - | 11.4 |
| HCM Lane LOS | A | A | - | - | B |
| HCM 95th %tile Q(veh) | 0 | - | - | - | 0.1 |

| Intersection | | | | | | | | | | | | |
|--------------------------|------|------|------|------|------|------|------|------|------|------|------|------|
| Int Delay, s/veh | 16.1 | | | | | | | | | | | |
| Movement | EBL | EBT | EBR | WBL | WBT | WBR | NBL | NBT | NBR | SBL | SBT | SBR |
| Lane Configurations | | ↕ | | | ↕ | | ↕ | ↑↑ | ↕ | ↕ | ↑↑ | ↕ |
| Traffic Vol, veh/h | 6 | 1 | 4 | 13 | 0 | 4 | 2 | 2543 | 26 | 1 | 1070 | 4 |
| Future Vol, veh/h | 6 | 1 | 4 | 13 | 0 | 4 | 2 | 2543 | 26 | 1 | 1070 | 4 |
| Conflicting Peds, #/hr | 0 | 0 | 0 | 0 | 0 | 0 | 0 | 0 | 0 | 0 | 0 | 0 |
| Sign Control | Stop | Stop | Stop | Stop | Stop | Stop | Free | Free | Free | Free | Free | Free |
| RT Channelized | - | - | None | - | - | None | - | - | None | - | - | None |
| Storage Length | - | - | - | - | - | - | 315 | - | 280 | 517 | - | - |
| Veh in Median Storage, # | - | 0 | - | - | 0 | - | - | 0 | - | - | 0 | - |
| Grade, % | - | 0 | - | - | 0 | - | - | 0 | - | - | 0 | - |
| Peak Hour Factor | 96 | 96 | 96 | 96 | 96 | 96 | 96 | 96 | 96 | 96 | 96 | 96 |
| Heavy Vehicles, % | 0 | 0 | 0 | 0 | 0 | 0 | 4 | 4 | 4 | 8 | 8 | 8 |
| Mvmt Flow | 6 | 1 | 4 | 14 | 0 | 4 | 2 | 2649 | 27 | 1 | 1115 | 4 |

| Major/Minor | Minor2 | | Minor1 | | Major1 | | | Major2 | | | | |
|----------------------|--------|------|--------|------|--------|------|------|--------|---|------|---|---|
| Conflicting Flow All | 2446 | 3797 | 558 | 3213 | 3774 | 1325 | 1119 | 0 | 0 | 2676 | 0 | 0 |
| Stage 1 | 1117 | 1117 | - | 2653 | 2653 | - | - | - | - | - | - | - |
| Stage 2 | 1329 | 2680 | - | 560 | 1121 | - | - | - | - | - | - | - |
| Critical Hdwy | 7.5 | 6.5 | 6.9 | 7.5 | 6.5 | 6.9 | 4.18 | - | - | 4.26 | - | - |
| Critical Hdwy Stg 1 | 6.5 | 5.5 | - | 6.5 | 5.5 | - | - | - | - | - | - | - |
| Critical Hdwy Stg 2 | 6.5 | 5.5 | - | 6.5 | 5.5 | - | - | - | - | - | - | - |
| Follow-up Hdwy | 3.5 | 4 | 3.3 | 3.5 | 4 | 3.3 | 2.24 | - | - | 2.28 | - | - |
| Pot Cap-1 Maneuver | 17 | 4 | 478 | ~4 | 4 | 149 | 608 | - | - | 138 | - | - |
| Stage 1 | 224 | 285 | - | 24 | 49 | - | - | - | - | - | - | - |
| Stage 2 | 166 | 47 | - | 485 | 284 | - | - | - | - | - | - | - |
| Platoon blocked, % | | | | | | | | - | - | - | - | - |
| Mov Cap-1 Maneuver | 16 | 4 | 478 | ~3 | 4 | 149 | 608 | - | - | 138 | - | - |
| Mov Cap-2 Maneuver | 16 | 4 | - | ~3 | 4 | - | - | - | - | - | - | - |
| Stage 1 | 223 | 283 | - | 24 | 49 | - | - | - | - | - | - | - |
| Stage 2 | 161 | 47 | - | 476 | 282 | - | - | - | - | - | - | - |

| Approach | EB | | WB | | NB | | SB | |
|----------------------|----------|--|-----------|--|----|--|----|--|
| HCM Control Delay, s | \$ 407.3 | | \$ 3221.3 | | 0 | | 0 | |
| HCM LOS | F | | F | | | | | |

| Minor Lane/Major Mvmt | NBL | NBT | NBR | EBLn1 | WBLn1 | SBL | SBT | SBR |
|-----------------------|-------|-----|-----|----------|-----------|-------|-----|-----|
| Capacity (veh/h) | 608 | - | - | 17 | 4 | 138 | - | - |
| HCM Lane V/C Ratio | 0.003 | - | - | 0.674 | 4.427 | 0.008 | - | - |
| HCM Control Delay (s) | 10.9 | - | - | \$ 407.3 | \$ 3221.3 | 31.3 | - | - |
| HCM Lane LOS | B | - | - | F | F | D | - | - |
| HCM 95th %tile Q(veh) | 0 | - | - | 1.8 | 3.6 | 0 | - | - |

Notes
 ~: Volume exceeds capacity \$: Delay exceeds 300s +: Computation Not Defined *: All major volume in platoon

HCM Unsignalized Intersection Capacity Analysis
 1: US 23/Cornelia Hwy & Americold Logistics Driveway

2028 AM Peak Hour
 2028 AM Peak Hour No Build Conditions



| Movement | EBL | EBR | NBL | NBT | SBU | SBT | SBR | |
|-----------------------------------|-------|-------|-------|------|------|----------------------|------|------|
| Lane Configurations | | | | | | | | |
| Traffic Volume (veh/h) | 7 | 22 | 69 | 1047 | 1 | 2625 | 40 | |
| Future Volume (Veh/h) | 7 | 22 | 69 | 1047 | 1 | 2625 | 40 | |
| Sign Control | Stop | | | Free | | Free | | |
| Grade | 0% | | | 0% | | 0% | | |
| Peak Hour Factor | 0.86 | 0.86 | 0.86 | 0.86 | 0.86 | 0.86 | 0.86 | |
| Hourly flow rate (vph) | 8 | 26 | 80 | 1217 | 0 | 3052 | 47 | |
| Pedestrians | | | | | | | | |
| Lane Width (ft) | | | | | | | | |
| Walking Speed (ft/s) | | | | | | | | |
| Percent Blockage | | | | | | | | |
| Right turn flare (veh) | | | | | | | | |
| Median type | | | | None | None | | | |
| Median storage (veh) | | | | | | | | |
| Upstream signal (ft) | | | | | | | | |
| pX, platoon unblocked | | | | | 0.00 | | | |
| vC, conflicting volume | 3820 | 1526 | 3099 | 0 | | | | |
| vC1, stage 1 conf vol | | | | | | | | |
| vC2, stage 2 conf vol | | | | | | | | |
| vCu, unblocked vol | 3820 | 1526 | 3099 | 0 | | | | |
| tC, single (s) | 7.1 | 7.2 | 4.3 | 0.0 | | | | |
| tC, 2 stage (s) | | | | | | | | |
| tF (s) | 3.7 | 3.5 | 2.3 | 0.0 | | | | |
| p0 queue free % | 0 | 72 | 8 | 0 | | | | |
| cM capacity (veh/h) | 0 | 92 | 87 | 0 | | | | |
| Direction, Lane # | EB 1 | NB 1 | NB 2 | NB 3 | SB 1 | SB 2 | SB 3 | SB 4 |
| Volume Total | 34 | 80 | 608 | 608 | 1526 | 1526 | 47 | 0 |
| Volume Left | 8 | 80 | 0 | 0 | 0 | 0 | 0 | 0 |
| Volume Right | 26 | 0 | 0 | 0 | 0 | 0 | 47 | 0 |
| cSH | 1 | 87 | 1700 | 1700 | 1700 | 1700 | 1700 | 1700 |
| Volume to Capacity | 49.33 | 0.92 | 0.36 | 0.36 | 0.90 | 0.90 | 0.03 | 0.00 |
| Queue Length 95th (ft) | Err | 126 | 0 | 0 | 0 | 0 | 0 | 0 |
| Control Delay (s) | Err | 159.9 | 0.0 | 0.0 | 0.0 | 0.0 | 0.0 | 0.0 |
| Lane LOS | F | F | | | | | | |
| Approach Delay (s) | Err | 9.9 | | | 0.0 | | | |
| Approach LOS | F | | | | | | | |
| Intersection Summary | | | | | | | | |
| Average Delay | | | 79.6 | | | | | |
| Intersection Capacity Utilization | | | 82.6% | | | ICU Level of Service | | E |
| Analysis Period (min) | | | 15 | | | | | |

HCM Unsignalized Intersection Capacity Analysis
 3: Cagle Mill Rd & Julian Baugh Rd

2028 AM Peak Hour
 2028 AM Peak Hour No Build Conditions

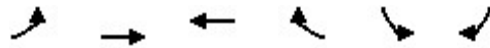

| Movement | EBL | EBT | WBT | WBR | SBL | SBR |
|-----------------------------------|------|------|------|----------------------|------|------|
| Lane Configurations | | | | | | |
| Traffic Volume (veh/h) | 5 | 0 | 1 | 13 | 6 | 4 |
| Future Volume (Veh/h) | 5 | 0 | 1 | 13 | 6 | 4 |
| Sign Control | | Stop | Stop | | Free | |
| Grade | | 0% | 0% | | 0% | |
| Peak Hour Factor | 0.72 | 0.72 | 0.72 | 0.72 | 0.72 | 0.72 |
| Hourly flow rate (vph) | 7 | 0 | 1 | 18 | 8 | 6 |
| Pedestrians | | | | | | |
| Lane Width (ft) | | | | | | |
| Walking Speed (ft/s) | | | | | | |
| Percent Blockage | | | | | | |
| Right turn flare (veh) | | | | | | |
| Median type | | | | | | |
| Median storage (veh) | | | | | | |
| Upstream signal (ft) | | | | | | |
| pX, platoon unblocked | | | | | | |
| vC, conflicting volume | 34 | 16 | 22 | 0 | 0 | |
| vC1, stage 1 conf vol | | | | | | |
| vC2, stage 2 conf vol | | | | | | |
| vCu, unblocked vol | 34 | 16 | 22 | 0 | 0 | |
| tC, single (s) | 7.1 | 6.5 | 6.5 | 6.2 | 4.1 | |
| tC, 2 stage (s) | | | | | | |
| tF (s) | 3.5 | 4.0 | 4.0 | 3.3 | 2.2 | |
| p0 queue free % | 99 | 100 | 100 | 98 | 100 | |
| cM capacity (veh/h) | 957 | 878 | 871 | 1091 | 1636 | |
| Direction, Lane # | EB 1 | WB 1 | SB 1 | | | |
| Volume Total | 7 | 19 | 14 | | | |
| Volume Left | 7 | 0 | 8 | | | |
| Volume Right | 0 | 18 | 6 | | | |
| cSH | 957 | 1077 | 1636 | | | |
| Volume to Capacity | 0.01 | 0.02 | 0.00 | | | |
| Queue Length 95th (ft) | 1 | 1 | 0 | | | |
| Control Delay (s) | 8.8 | 8.4 | 4.1 | | | |
| Lane LOS | A | A | A | | | |
| Approach Delay (s) | 8.8 | 8.4 | 4.1 | | | |
| Approach LOS | A | A | | | | |
| Intersection Summary | | | | | | |
| Average Delay | | | 7.0 | | | |
| Intersection Capacity Utilization | | | Err% | ICU Level of Service | | H |
| Analysis Period (min) | | | 15 | | | |

| Intersection | | | | | | |
|--------------------------|------|------|------|------|------|------|
| Int Delay, s/veh | 4.3 | | | | | |
| Movement | EBT | EBR | WBL | WBT | NBL | NBR |
| Lane Configurations | | | | | | |
| Traffic Vol, veh/h | 4 | 7 | 2 | 8 | 16 | 1 |
| Future Vol, veh/h | 4 | 7 | 2 | 8 | 16 | 1 |
| Conflicting Peds, #/hr | 0 | 0 | 0 | 0 | 0 | 0 |
| Sign Control | Free | Free | Free | Free | Stop | Stop |
| RT Channelized | - | None | - | None | - | None |
| Storage Length | - | - | - | - | 0 | - |
| Veh in Median Storage, # | 0 | - | - | 0 | 0 | - |
| Grade, % | 0 | - | - | 0 | 0 | - |
| Peak Hour Factor | 62 | 62 | 62 | 62 | 62 | 62 |
| Heavy Vehicles, % | 0 | 0 | 0 | 0 | 0 | 0 |
| Mvmt Flow | 6 | 11 | 3 | 13 | 26 | 2 |

| Major/Minor | Major1 | Major2 | Minor1 | | |
|----------------------|--------|--------|--------|---|------|
| Conflicting Flow All | 0 | 0 | 17 | 0 | 31 |
| Stage 1 | - | - | - | - | 12 |
| Stage 2 | - | - | - | - | 19 |
| Critical Hdwy | - | - | 4.1 | - | 6.4 |
| Critical Hdwy Stg 1 | - | - | - | - | 5.4 |
| Critical Hdwy Stg 2 | - | - | - | - | 5.4 |
| Follow-up Hdwy | - | - | 2.2 | - | 3.5 |
| Pot Cap-1 Maneuver | - | - | 1613 | - | 988 |
| Stage 1 | - | - | - | - | 1016 |
| Stage 2 | - | - | - | - | 1009 |
| Platoon blocked, % | - | - | - | - | - |
| Mov Cap-1 Maneuver | - | - | 1613 | - | 986 |
| Mov Cap-2 Maneuver | - | - | - | - | 986 |
| Stage 1 | - | - | - | - | 1016 |
| Stage 2 | - | - | - | - | 1007 |

| Approach | EB | WB | NB |
|----------------------|----|-----|-----|
| HCM Control Delay, s | 0 | 1.4 | 8.7 |
| HCM LOS | | | A |

| Minor Lane/Major Mvmt | NBLn1 | EBT | EBR | WBL | WBT |
|-----------------------|-------|-----|-----|-------|-----|
| Capacity (veh/h) | 991 | - | - | 1613 | - |
| HCM Lane V/C Ratio | 0.028 | - | - | 0.002 | - |
| HCM Control Delay (s) | 8.7 | - | - | 7.2 | 0 |
| HCM Lane LOS | A | - | - | A | A |
| HCM 95th %tile Q(veh) | 0.1 | - | - | 0 | - |

| Intersection | | | | | | | | | | | | |
|--------------------------|------|------|------|------|------|------|------|------|------|------|------|------|
| Int Delay, s/veh | 6.6 | | | | | | | | | | | |
| Movement | EBL | EBT | EBR | WBL | WBT | WBR | NBL | NBT | NBR | SBL | SBT | SBR |
| Lane Configurations | | ↕ | | | ↕ | | | ↕ | | | ↕ | |
| Traffic Vol, veh/h | 1 | 5 | 2 | 0 | 20 | 2 | 1 | 1 | 1 | 1 | 8 | 2 |
| Future Vol, veh/h | 1 | 5 | 2 | 0 | 20 | 2 | 1 | 1 | 1 | 1 | 8 | 2 |
| Conflicting Peds, #/hr | 0 | 0 | 0 | 0 | 0 | 0 | 0 | 0 | 0 | 0 | 0 | 0 |
| Sign Control | Stop | Stop | Stop | Stop | Stop | Stop | Free | Free | Free | Free | Free | Free |
| RT Channelized | - | - | None | - | - | None | - | - | None | - | - | None |
| Storage Length | - | - | - | - | - | - | - | - | - | - | - | - |
| Veh in Median Storage, # | - | 0 | - | - | 0 | - | - | 0 | - | - | 0 | - |
| Grade, % | - | 0 | - | - | 0 | - | - | 0 | - | - | 0 | - |
| Peak Hour Factor | 79 | 79 | 79 | 79 | 79 | 79 | 79 | 79 | 79 | 79 | 79 | 79 |
| Heavy Vehicles, % | 14 | 14 | 14 | 6 | 6 | 6 | 33 | 33 | 33 | 10 | 10 | 10 |
| Mvmt Flow | 1 | 6 | 3 | 0 | 25 | 3 | 1 | 1 | 1 | 1 | 10 | 3 |

| Major/Minor | Minor2 | | Minor1 | | Major1 | | | Major2 | | | | |
|----------------------|--------|-------|--------|-------|--------|-------|-------|--------|---|------|---|---|
| Conflicting Flow All | 32 | 18 | 12 | 22 | 19 | 2 | 13 | 0 | 0 | 2 | 0 | 0 |
| Stage 1 | 14 | 14 | - | 4 | 4 | - | - | - | - | - | - | - |
| Stage 2 | 18 | 4 | - | 18 | 15 | - | - | - | - | - | - | - |
| Critical Hdwy | 7.24 | 6.64 | 6.34 | 7.16 | 6.56 | 6.26 | 4.43 | - | - | 4.2 | - | - |
| Critical Hdwy Stg 1 | 6.24 | 5.64 | - | 6.16 | 5.56 | - | - | - | - | - | - | - |
| Critical Hdwy Stg 2 | 6.24 | 5.64 | - | 6.16 | 5.56 | - | - | - | - | - | - | - |
| Follow-up Hdwy | 3.626 | 4.126 | 3.426 | 3.554 | 4.054 | 3.354 | 2.497 | - | - | 2.29 | - | - |
| Pot Cap-1 Maneuver | 946 | 853 | 1035 | 980 | 867 | 1071 | 1425 | - | - | 1569 | - | - |
| Stage 1 | 976 | 860 | - | 1008 | 885 | - | - | - | - | - | - | - |
| Stage 2 | 971 | 869 | - | 991 | 875 | - | - | - | - | - | - | - |
| Platoon blocked, % | | | | | | | | - | - | - | - | - |
| Mov Cap-1 Maneuver | 921 | 851 | 1035 | 970 | 865 | 1071 | 1425 | - | - | 1569 | - | - |
| Mov Cap-2 Maneuver | 921 | 851 | - | 970 | 865 | - | - | - | - | - | - | - |
| Stage 1 | 975 | 859 | - | 1007 | 884 | - | - | - | - | - | - | - |
| Stage 2 | 940 | 868 | - | 980 | 874 | - | - | - | - | - | - | - |

| Approach | EB | | WB | | NB | | SB | |
|----------------------|----|--|-----|--|-----|--|-----|--|
| HCM Control Delay, s | 9 | | 9.2 | | 2.5 | | 0.7 | |
| HCM LOS | A | | A | | | | | |

| Minor Lane/Major Mvmt | NBL | NBT | NBR | EBLn1 | WBLn1 | SBL | SBT | SBR |
|-----------------------|-------|-----|-----|-------|-------|-------|-----|-----|
| Capacity (veh/h) | 1425 | - | - | 900 | 880 | 1569 | - | - |
| HCM Lane V/C Ratio | 0.001 | - | - | 0.011 | 0.032 | 0.001 | - | - |
| HCM Control Delay (s) | 7.5 | 0 | - | 9 | 9.2 | 7.3 | 0 | - |
| HCM Lane LOS | A | A | - | A | A | A | A | - |
| HCM 95th %tile Q(veh) | 0 | - | - | 0 | 0.1 | 0 | - | - |

| Intersection | | | | | | |
|--------------------------|------|------|------|------|------|------|
| Int Delay, s/veh | 0.2 | | | | | |
| Movement | EBL | EBT | WBT | WBR | SBL | SBR |
| Lane Configurations | | ↶ | ↷ | | ↶ | ↷ |
| Traffic Vol, veh/h | 0 | 100 | 452 | 2 | 1 | 8 |
| Future Vol, veh/h | 0 | 100 | 452 | 2 | 1 | 8 |
| Conflicting Peds, #/hr | 0 | 0 | 0 | 0 | 0 | 0 |
| Sign Control | Free | Free | Free | Free | Stop | Stop |
| RT Channelized | - | None | - | None | - | None |
| Storage Length | - | - | - | - | 0 | - |
| Veh in Median Storage, # | - | 0 | 0 | - | 0 | - |
| Grade, % | - | 0 | 0 | - | 0 | - |
| Peak Hour Factor | 89 | 89 | 89 | 89 | 89 | 89 |
| Heavy Vehicles, % | 9 | 9 | 3 | 3 | 13 | 13 |
| Mvmt Flow | 0 | 112 | 508 | 2 | 1 | 9 |

| Major/Minor | Major1 | Major2 | Minor2 | | |
|----------------------|--------|--------|--------|---|-------------|
| Conflicting Flow All | 510 | 0 | - | 0 | 621 509 |
| Stage 1 | - | - | - | - | 509 - |
| Stage 2 | - | - | - | - | 112 - |
| Critical Hdwy | 4.19 | - | - | - | 6.53 6.33 |
| Critical Hdwy Stg 1 | - | - | - | - | 5.53 - |
| Critical Hdwy Stg 2 | - | - | - | - | 5.53 - |
| Follow-up Hdwy | 2.281 | - | - | - | 3.617 3.417 |
| Pot Cap-1 Maneuver | 1020 | - | - | - | 434 543 |
| Stage 1 | - | - | - | - | 582 - |
| Stage 2 | - | - | - | - | 886 - |
| Platoon blocked, % | | - | - | - | |
| Mov Cap-1 Maneuver | 1020 | - | - | - | 434 543 |
| Mov Cap-2 Maneuver | - | - | - | - | 434 - |
| Stage 1 | - | - | - | - | 582 - |
| Stage 2 | - | - | - | - | 886 - |

| Approach | EB | WB | SB |
|----------------------|----|----|----|
| HCM Control Delay, s | 0 | 0 | 12 |
| HCM LOS | | | B |

| Minor Lane/Major Mvmt | EBL | EBT | WBT | WBR | SBLn1 |
|-----------------------|------|-----|-----|-----|-------|
| Capacity (veh/h) | 1020 | - | - | - | 528 |
| HCM Lane V/C Ratio | - | - | - | - | 0.019 |
| HCM Control Delay (s) | 0 | - | - | - | 12 |
| HCM Lane LOS | A | - | - | - | B |
| HCM 95th %tile Q(veh) | 0 | - | - | - | 0.1 |

| Intersection | | | | | | | | | | | | |
|--------------------------|------|------|------|------|------|------|------|------|------|------|------|------|
| Int Delay, s/veh | 17.7 | | | | | | | | | | | |
| Movement | EBL | EBT | EBR | WBL | WBT | WBR | NBL | NBT | NBR | SBL | SBT | SBR |
| Lane Configurations | | ↕ | | | ↕ | | ↕ | ↑↑ | ↕ | ↕ | ↑↑ | ↕ |
| Traffic Vol, veh/h | 2 | 0 | 1 | 27 | 2 | 1 | 0 | 942 | 0 | 0 | 2639 | 2 |
| Future Vol, veh/h | 2 | 0 | 1 | 27 | 2 | 1 | 0 | 942 | 0 | 0 | 2639 | 2 |
| Conflicting Peds, #/hr | 0 | 0 | 0 | 0 | 0 | 0 | 0 | 0 | 0 | 0 | 0 | 0 |
| Sign Control | Stop | Stop | Stop | Stop | Stop | Stop | Free | Free | Free | Free | Free | Free |
| RT Channelized | - | - | None | - | - | None | - | - | None | - | - | None |
| Storage Length | - | - | - | - | - | - | 315 | - | 280 | 517 | - | - |
| Veh in Median Storage, # | - | 0 | - | - | 0 | - | - | 0 | - | - | 0 | - |
| Grade, % | - | 0 | - | - | 0 | - | - | 0 | - | - | 0 | - |
| Peak Hour Factor | 85 | 85 | 85 | 85 | 85 | 85 | 85 | 85 | 85 | 85 | 85 | 85 |
| Heavy Vehicles, % | 50 | 50 | 50 | 0 | 0 | 0 | 11 | 11 | 11 | 4 | 4 | 4 |
| Mvmt Flow | 2 | 0 | 1 | 32 | 2 | 1 | 0 | 1108 | 0 | 0 | 3105 | 2 |

| Major/Minor | Minor2 | | Minor1 | | Major1 | | Major2 | | | | | |
|----------------------|--------|------|--------|------|--------|-----|--------|---|---|------|---|---|
| Conflicting Flow All | 3660 | 4213 | 1553 | 2661 | 4215 | 554 | 3107 | 0 | 0 | 1108 | 0 | 0 |
| Stage 1 | 3105 | 3105 | - | 1108 | 1108 | - | - | - | - | - | - | - |
| Stage 2 | 555 | 1108 | - | 1553 | 3107 | - | - | - | - | - | - | - |
| Critical Hdwy | 8.5 | 7.5 | 7.9 | 7.5 | 6.5 | 6.9 | 4.32 | - | - | 4.18 | - | - |
| Critical Hdwy Stg 1 | 7.5 | 6.5 | - | 6.5 | 5.5 | - | - | - | - | - | - | - |
| Critical Hdwy Stg 2 | 7.5 | 6.5 | - | 6.5 | 5.5 | - | - | - | - | - | - | - |
| Follow-up Hdwy | 4 | 4.5 | 3.8 | 3.5 | 4 | 3.3 | 2.31 | - | - | 2.24 | - | - |
| Pot Cap-1 Maneuver | ~ 1 | 1 | 64 | ~ 11 | ~ 2 | 481 | 86 | - | - | 614 | - | - |
| Stage 1 | 5 | 12 | - | 227 | 288 | - | - | - | - | - | - | - |
| Stage 2 | 379 | 200 | - | 121 | 28 | - | - | - | - | - | - | - |
| Platoon blocked, % | - | - | - | - | - | - | - | - | - | - | - | - |
| Mov Cap-1 Maneuver | - | 1 | 64 | ~ 11 | ~ 2 | 481 | 86 | - | - | 614 | - | - |
| Mov Cap-2 Maneuver | - | 1 | - | ~ 11 | ~ 2 | - | - | - | - | - | - | - |
| Stage 1 | 5 | 12 | - | 227 | 288 | - | - | - | - | - | - | - |
| Stage 2 | 375 | 200 | - | 119 | 28 | - | - | - | - | - | - | - |

| Approach | EB | WB | NB | SB |
|----------------------|----|-----------|----|----|
| HCM Control Delay, s | | \$ 2129.1 | 0 | 0 |
| HCM LOS | - | F | | |

| Minor Lane/Major Mvmt | NBL | NBT | NBR | EBLn1WBLn1 | SBL | SBT | SBR |
|-----------------------|-----|-----|-----|------------|-------|-----|-----|
| Capacity (veh/h) | 86 | - | - | - | 9 | 614 | - |
| HCM Lane V/C Ratio | - | - | - | - | 3.922 | - | - |
| HCM Control Delay (s) | 0 | - | - | \$ 2129.1 | 0 | - | - |
| HCM Lane LOS | A | - | - | - | F | A | - |
| HCM 95th %tile Q(veh) | 0 | - | - | - | 5.6 | 0 | - |

Notes
 ~: Volume exceeds capacity \$: Delay exceeds 300s +: Computation Not Defined *: All major volume in platoon

HCM Unsignalized Intersection Capacity Analysis
 1: US 23/Cornelia Hwy & Americold Logistics Driveway

2028 PM Peak Hour
 2028 PM Peak Hour No Build Conditions



| Movement | EBL | EBR | NBL | NBT | SBU | SBT | SBR | |
|-----------------------------------|-------------|-------------|-------------|----------------------|-------------|-------------|-------------|-------------|
| Lane Configurations | W | | W | ↑↑ | ↓ | ↑↑ | ↑ | |
| Traffic Volume (veh/h) | 23 | 31 | 7 | 2998 | 2 | 1254 | 9 | |
| Future Volume (Veh/h) | 23 | 31 | 7 | 2998 | 2 | 1254 | 9 | |
| Sign Control | Stop | | | Free | | Free | | |
| Grade | 0% | | | 0% | | 0% | | |
| Peak Hour Factor | 0.95 | 0.95 | 0.95 | 0.95 | 0.95 | 0.95 | 0.95 | |
| Hourly flow rate (vph) | 24 | 33 | 7 | 3156 | 0 | 1320 | 9 | |
| Pedestrians | | | | | | | | |
| Lane Width (ft) | | | | | | | | |
| Walking Speed (ft/s) | | | | | | | | |
| Percent Blockage | | | | | | | | |
| Right turn flare (veh) | | | | | | | | |
| Median type | | | | None | None | | | |
| Median storage (veh) | | | | | | | | |
| Upstream signal (ft) | | | | | | | | |
| pX, platoon unblocked | | | | | 0.00 | | | |
| vC, conflicting volume | 2912 | 660 | 1329 | 0 | | | | |
| vC1, stage 1 conf vol | | | | | | | | |
| vC2, stage 2 conf vol | | | | | | | | |
| vCu, unblocked vol | 2912 | 660 | 1329 | 0 | | | | |
| tC, single (s) | 7.2 | 7.3 | 4.2 | 0.0 | | | | |
| tC, 2 stage (s) | | | | | | | | |
| tF (s) | 3.7 | 3.5 | 2.2 | 0.0 | | | | |
| p0 queue free % | 0 | 91 | 99 | 0 | | | | |
| cM capacity (veh/h) | 9 | 368 | 505 | 0 | | | | |
| Direction, Lane # | EB 1 | NB 1 | NB 2 | NB 3 | SB 1 | SB 2 | SB 3 | SB 4 |
| Volume Total | 57 | 7 | 1578 | 1578 | 660 | 660 | 9 | 0 |
| Volume Left | 24 | 7 | 0 | 0 | 0 | 0 | 0 | 0 |
| Volume Right | 33 | 0 | 0 | 0 | 0 | 0 | 9 | 0 |
| cSH | 21 | 505 | 1700 | 1700 | 1700 | 1700 | 1700 | 1700 |
| Volume to Capacity | 2.73 | 0.01 | 0.93 | 0.93 | 0.39 | 0.39 | 0.01 | 0.00 |
| Queue Length 95th (ft) | 185 | 1 | 0 | 0 | 0 | 0 | 0 | 0 |
| Control Delay (s) | 1170.2 | 12.2 | 0.0 | 0.0 | 0.0 | 0.0 | 0.0 | 0.0 |
| Lane LOS | F | B | | | | | | |
| Approach Delay (s) | 1170.2 | 0.0 | 0.0 | | | | | |
| Approach LOS | F | | | | | | | |
| Intersection Summary | | | | | | | | |
| Average Delay | | | 14.7 | | | | | |
| Intersection Capacity Utilization | | | 92.9% | ICU Level of Service | | | F | |
| Analysis Period (min) | | | 15 | | | | | |

HCM Unsignalized Intersection Capacity Analysis
 3: Cagle Mill Rd & Julian Baugh Rd

2028 PM Peak Hour
 2028 PM Peak Hour No Build Conditions

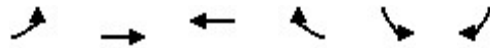

| Movement | EBL | EBT | WBT | WBR | SBL | SBR |
|-----------------------------------|-------------|-------------|-------------|----------------------|------|------|
| Lane Configurations | ↶ | | ↷ | | | ↶ |
| Traffic Volume (veh/h) | 2 | 0 | 1 | 13 | 27 | 2 |
| Future Volume (Veh/h) | 2 | 0 | 1 | 13 | 27 | 2 |
| Sign Control | | Stop | Stop | | Free | |
| Grade | | 0% | 0% | | 0% | |
| Peak Hour Factor | 0.75 | 0.75 | 0.75 | 0.75 | 0.75 | 0.75 |
| Hourly flow rate (vph) | 3 | 0 | 1 | 17 | 36 | 3 |
| Pedestrians | | | | | | |
| Lane Width (ft) | | | | | | |
| Walking Speed (ft/s) | | | | | | |
| Percent Blockage | | | | | | |
| Right turn flare (veh) | | | | | | |
| Median type | None | | | | | |
| Median storage (veh) | | | | | | |
| Upstream signal (ft) | | | | | | |
| pX, platoon unblocked | | | | | | |
| vC, conflicting volume | 90 | 72 | 75 | 0 | 0 | |
| vC1, stage 1 conf vol | | | | | | |
| vC2, stage 2 conf vol | | | | | | |
| vCu, unblocked vol | 90 | 72 | 75 | 0 | 0 | |
| tC, single (s) | 7.1 | 6.5 | 6.5 | 6.2 | 4.1 | |
| tC, 2 stage (s) | | | | | | |
| tF (s) | 3.5 | 4.0 | 4.0 | 3.3 | 2.2 | |
| p0 queue free % | 100 | 100 | 100 | 98 | 98 | |
| cM capacity (veh/h) | 870 | 804 | 801 | 1091 | 1636 | |
| Direction, Lane # | EB 1 | WB 1 | SB 1 | | | |
| Volume Total | 3 | 18 | 39 | | | |
| Volume Left | 3 | 0 | 36 | | | |
| Volume Right | 0 | 17 | 3 | | | |
| cSH | 870 | 1069 | 1636 | | | |
| Volume to Capacity | 0.00 | 0.02 | 0.02 | | | |
| Queue Length 95th (ft) | 0 | 1 | 2 | | | |
| Control Delay (s) | 9.2 | 8.4 | 6.7 | | | |
| Lane LOS | A | A | A | | | |
| Approach Delay (s) | 9.2 | 8.4 | 6.7 | | | |
| Approach LOS | A | A | | | | |
| Intersection Summary | | | | | | |
| Average Delay | | | 7.3 | | | |
| Intersection Capacity Utilization | | | Err% | ICU Level of Service | H | |
| Analysis Period (min) | | | 15 | | | |

| Intersection | | | | | | |
|--------------------------|------|------|------|------|------|------|
| Int Delay, s/veh | 2.7 | | | | | |
| Movement | EBT | EBR | WBL | WBT | NBL | NBR |
| Lane Configurations | | | | | | |
| Traffic Vol, veh/h | 20 | 18 | 2 | 7 | 13 | 6 |
| Future Vol, veh/h | 20 | 18 | 2 | 7 | 13 | 6 |
| Conflicting Peds, #/hr | 0 | 0 | 0 | 0 | 0 | 0 |
| Sign Control | Free | Free | Free | Free | Stop | Stop |
| RT Channelized | - | None | - | None | - | None |
| Storage Length | - | - | - | - | 0 | - |
| Veh in Median Storage, # | 0 | - | - | 0 | 0 | - |
| Grade, % | 0 | - | - | 0 | 0 | - |
| Peak Hour Factor | 87 | 87 | 87 | 87 | 87 | 87 |
| Heavy Vehicles, % | 0 | 0 | 0 | 0 | 0 | 0 |
| Mvmt Flow | 23 | 21 | 2 | 8 | 15 | 7 |

| Major/Minor | Major1 | Major2 | Minor1 | | |
|----------------------|--------|--------|--------|---|------|
| Conflicting Flow All | 0 | 0 | 44 | 0 | 46 |
| Stage 1 | - | - | - | - | 34 |
| Stage 2 | - | - | - | - | 12 |
| Critical Hdwy | - | - | 4.1 | - | 6.4 |
| Critical Hdwy Stg 1 | - | - | - | - | 5.4 |
| Critical Hdwy Stg 2 | - | - | - | - | 5.4 |
| Follow-up Hdwy | - | - | 2.2 | - | 3.5 |
| Pot Cap-1 Maneuver | - | - | 1577 | - | 969 |
| Stage 1 | - | - | - | - | 994 |
| Stage 2 | - | - | - | - | 1016 |
| Platoon blocked, % | - | - | - | - | - |
| Mov Cap-1 Maneuver | - | - | 1577 | - | 968 |
| Mov Cap-2 Maneuver | - | - | - | - | 968 |
| Stage 1 | - | - | - | - | 994 |
| Stage 2 | - | - | - | - | 1015 |

| Approach | EB | WB | NB |
|----------------------|----|-----|-----|
| HCM Control Delay, s | 0 | 1.6 | 8.7 |
| HCM LOS | | | A |

| Minor Lane/Major Mvmt | NBLn1 | EBT | EBR | WBL | WBT |
|-----------------------|-------|-----|-----|-------|-----|
| Capacity (veh/h) | 991 | - | - | 1577 | - |
| HCM Lane V/C Ratio | 0.022 | - | - | 0.001 | - |
| HCM Control Delay (s) | 8.7 | - | - | 7.3 | 0 |
| HCM Lane LOS | A | - | - | A | A |
| HCM 95th %tile Q(veh) | 0.1 | - | - | 0 | - |

| Intersection | | | | | | | | | | | | |
|--------------------------|------|------|------|------|------|------|------|------|------|------|------|------|
| Int Delay, s/veh | 7.2 | | | | | | | | | | | |
| Movement | EBL | EBT | EBR | WBL | WBT | WBR | NBL | NBT | NBR | SBL | SBT | SBR |
| Lane Configurations | | ↕ | | | ↕ | | | ↕ | | | ↕ | |
| Traffic Vol, veh/h | 5 | 18 | 6 | 8 | 9 | 0 | 9 | 2 | 8 | 1 | 2 | 1 |
| Future Vol, veh/h | 5 | 18 | 6 | 8 | 9 | 0 | 9 | 2 | 8 | 1 | 2 | 1 |
| Conflicting Peds, #/hr | 0 | 0 | 0 | 0 | 0 | 0 | 0 | 0 | 0 | 0 | 0 | 0 |
| Sign Control | Stop | Stop | Stop | Stop | Stop | Stop | Free | Free | Free | Free | Free | Free |
| RT Channelized | - | - | None | - | - | None | - | - | None | - | - | None |
| Storage Length | - | - | - | - | - | - | - | - | - | - | - | - |
| Veh in Median Storage, # | - | 0 | - | - | 0 | - | - | 0 | - | - | 0 | - |
| Grade, % | - | 0 | - | - | 0 | - | - | 0 | - | - | 0 | - |
| Peak Hour Factor | 78 | 78 | 78 | 78 | 78 | 78 | 78 | 78 | 78 | 78 | 78 | 78 |
| Heavy Vehicles, % | 0 | 0 | 0 | 7 | 7 | 7 | 6 | 6 | 6 | 0 | 0 | 0 |
| Mvmt Flow | 6 | 23 | 8 | 10 | 12 | 0 | 12 | 3 | 10 | 1 | 3 | 1 |

| Major/Minor | Minor2 | | Minor1 | | | Major1 | | Major2 | | | | |
|----------------------|--------|-----|--------|-------|-------|--------|-------|--------|---|------|---|---|
| Conflicting Flow All | 44 | 43 | 4 | 53 | 38 | 8 | 4 | 0 | 0 | 13 | 0 | 0 |
| Stage 1 | 6 | 6 | - | 32 | 32 | - | - | - | - | - | - | - |
| Stage 2 | 38 | 37 | - | 21 | 6 | - | - | - | - | - | - | - |
| Critical Hdwy | 7.1 | 6.5 | 6.2 | 7.17 | 6.57 | 6.27 | 4.16 | - | - | 4.1 | - | - |
| Critical Hdwy Stg 1 | 6.1 | 5.5 | - | 6.17 | 5.57 | - | - | - | - | - | - | - |
| Critical Hdwy Stg 2 | 6.1 | 5.5 | - | 6.17 | 5.57 | - | - | - | - | - | - | - |
| Follow-up Hdwy | 3.5 | 4 | 3.3 | 3.563 | 4.063 | 3.363 | 2.254 | - | - | 2.2 | - | - |
| Pot Cap-1 Maneuver | 963 | 853 | 1085 | 933 | 845 | 1060 | 1592 | - | - | 1619 | - | - |
| Stage 1 | 1021 | 895 | - | 972 | 859 | - | - | - | - | - | - | - |
| Stage 2 | 982 | 868 | - | 985 | 881 | - | - | - | - | - | - | - |
| Platoon blocked, % | | | | | | | | - | - | - | - | - |
| Mov Cap-1 Maneuver | 947 | 845 | 1085 | 901 | 837 | 1060 | 1592 | - | - | 1619 | - | - |
| Mov Cap-2 Maneuver | 947 | 845 | - | 901 | 837 | - | - | - | - | - | - | - |
| Stage 1 | 1013 | 894 | - | 964 | 852 | - | - | - | - | - | - | - |
| Stage 2 | 961 | 861 | - | 952 | 880 | - | - | - | - | - | - | - |

| Approach | EB | | WB | | NB | | SB | |
|----------------------|-----|--|-----|--|-----|--|-----|--|
| HCM Control Delay, s | 9.2 | | 9.3 | | 3.4 | | 1.8 | |
| HCM LOS | A | | A | | | | | |

| Minor Lane/Major Mvmt | NBL | NBT | NBR | EBLn1 | WBLn1 | SBL | SBT | SBR |
|-----------------------|-------|-----|-----|-------|-------|-------|-----|-----|
| Capacity (veh/h) | 1592 | - | - | 903 | 866 | 1619 | - | - |
| HCM Lane V/C Ratio | 0.007 | - | - | 0.041 | 0.025 | 0.001 | - | - |
| HCM Control Delay (s) | 7.3 | 0 | - | 9.2 | 9.3 | 7.2 | 0 | - |
| HCM Lane LOS | A | A | - | A | A | A | A | - |
| HCM 95th %tile Q(veh) | 0 | - | - | 0.1 | 0.1 | 0 | - | - |

| Intersection | | | | | | |
|--------------------------|------|------|------|------|------|------|
| Int Delay, s/veh | 0.4 | | | | | |
| Movement | EBL | EBT | WBT | WBR | SBL | SBR |
| Lane Configurations | | ↶ | ↷ | | ↶ | |
| Traffic Vol, veh/h | 13 | 383 | 157 | 8 | 7 | 4 |
| Future Vol, veh/h | 13 | 383 | 157 | 8 | 7 | 4 |
| Conflicting Peds, #/hr | 0 | 0 | 0 | 0 | 0 | 0 |
| Sign Control | Free | Free | Free | Free | Stop | Stop |
| RT Channelized | - | None | - | None | - | None |
| Storage Length | - | - | - | - | 0 | - |
| Veh in Median Storage, # | - | 0 | 0 | - | 0 | - |
| Grade, % | - | 0 | 0 | - | 0 | - |
| Peak Hour Factor | 87 | 87 | 87 | 87 | 87 | 87 |
| Heavy Vehicles, % | 2 | 2 | 5 | 5 | 0 | 0 |
| Mvmt Flow | 15 | 440 | 180 | 9 | 8 | 5 |

| Major/Minor | Major1 | Major2 | Minor2 | | |
|----------------------|--------|--------|--------|-----|-----|
| Conflicting Flow All | 189 | 0 | 0 | 655 | 185 |
| Stage 1 | - | - | - | 185 | - |
| Stage 2 | - | - | - | 470 | - |
| Critical Hdwy | 4.12 | - | - | 6.4 | 6.2 |
| Critical Hdwy Stg 1 | - | - | - | 5.4 | - |
| Critical Hdwy Stg 2 | - | - | - | 5.4 | - |
| Follow-up Hdwy | 2.218 | - | - | 3.5 | 3.3 |
| Pot Cap-1 Maneuver | 1385 | - | - | 434 | 862 |
| Stage 1 | - | - | - | 852 | - |
| Stage 2 | - | - | - | 633 | - |
| Platoon blocked, % | - | - | - | - | - |
| Mov Cap-1 Maneuver | 1385 | - | - | 428 | 862 |
| Mov Cap-2 Maneuver | - | - | - | 428 | - |
| Stage 1 | - | - | - | 840 | - |
| Stage 2 | - | - | - | 633 | - |

| Approach | EB | WB | SB |
|----------------------|-----|----|----|
| HCM Control Delay, s | 0.3 | 0 | 12 |
| HCM LOS | | | B |

| Minor Lane/Major Mvmt | EBL | EBT | WBT | WBR | SBLn1 |
|-----------------------|-------|-----|-----|-----|-------|
| Capacity (veh/h) | 1385 | - | - | - | 524 |
| HCM Lane V/C Ratio | 0.011 | - | - | - | 0.024 |
| HCM Control Delay (s) | 7.6 | 0 | - | - | 12 |
| HCM Lane LOS | A | A | - | - | B |
| HCM 95th %tile Q(veh) | 0 | - | - | - | 0.1 |

| Intersection | | | | | | | | | | | | |
|--------------------------|------|------|------|------|------|------|------|------|------|------|------|------|
| Int Delay, s/veh | 4.3 | | | | | | | | | | | |
| Movement | EBL | EBT | EBR | WBL | WBT | WBR | NBL | NBT | NBR | SBL | SBT | SBR |
| Lane Configurations | | ↕ | | | ↕ | | ↕ | ↑↑ | ↕ | ↕ | ↑↑ | ↕ |
| Traffic Vol, veh/h | 7 | 1 | 5 | 15 | 0 | 5 | 2 | 2984 | 31 | 1 | 1256 | 5 |
| Future Vol, veh/h | 7 | 1 | 5 | 15 | 0 | 5 | 2 | 2984 | 31 | 1 | 1256 | 5 |
| Conflicting Peds, #/hr | 0 | 0 | 0 | 0 | 0 | 0 | 0 | 0 | 0 | 0 | 0 | 0 |
| Sign Control | Stop | Stop | Stop | Stop | Stop | Stop | Free | Free | Free | Free | Free | Free |
| RT Channelized | - | - | None | - | - | None | - | - | None | - | - | None |
| Storage Length | - | - | - | - | - | - | 315 | - | 280 | 517 | - | - |
| Veh in Median Storage, # | - | 0 | - | - | 0 | - | - | 0 | - | - | 0 | - |
| Grade, % | - | 0 | - | - | 0 | - | - | 0 | - | - | 0 | - |
| Peak Hour Factor | 96 | 96 | 96 | 96 | 96 | 96 | 96 | 96 | 96 | 96 | 96 | 96 |
| Heavy Vehicles, % | 0 | 0 | 0 | 0 | 0 | 0 | 4 | 4 | 4 | 8 | 8 | 8 |
| Mvmt Flow | 7 | 1 | 5 | 16 | 0 | 5 | 2 | 3108 | 32 | 1 | 1308 | 5 |

| Major/Minor | Minor2 | | Minor1 | | Major1 | | | Major2 | | | | |
|----------------------|--------|------|--------|------|--------|------|------|--------|---|------|---|---|
| Conflicting Flow All | 2868 | 4454 | 654 | 3769 | 4427 | 1554 | 1313 | 0 | 0 | 3140 | 0 | 0 |
| Stage 1 | 1310 | 1310 | - | 3112 | 3112 | - | - | - | - | - | - | - |
| Stage 2 | 1558 | 3144 | - | 657 | 1315 | - | - | - | - | - | - | - |
| Critical Hdwy | 7.5 | 6.5 | 6.9 | 7.5 | 6.5 | 6.9 | 4.18 | - | - | 4.26 | - | - |
| Critical Hdwy Stg 1 | 6.5 | 5.5 | - | 6.5 | 5.5 | - | - | - | - | - | - | - |
| Critical Hdwy Stg 2 | 6.5 | 5.5 | - | 6.5 | 5.5 | - | - | - | - | - | - | - |
| Follow-up Hdwy | 3.5 | 4 | 3.3 | 3.5 | 4 | 3.3 | 2.24 | - | - | 2.28 | - | - |
| Pot Cap-1 Maneuver | 8 | ~ 1 | 414 | ~ 2 | 2 | 104 | 512 | - | - | 89 | - | - |
| Stage 1 | 171 | 231 | - | ~ 12 | 28 | - | - | - | - | - | - | - |
| Stage 2 | 120 | 27 | - | 425 | 230 | - | - | - | - | - | - | - |
| Platoon blocked, % | | | | | | | | - | - | - | - | - |
| Mov Cap-1 Maneuver | 8 | ~ 1 | 414 | - | 2 | 104 | 512 | - | - | 89 | - | - |
| Mov Cap-2 Maneuver | 8 | ~ 1 | - | - | 2 | - | - | - | - | - | - | - |
| Stage 1 | 170 | 228 | - | ~ 12 | 28 | - | - | - | - | - | - | - |
| Stage 2 | 114 | 27 | - | 413 | 227 | - | - | - | - | - | - | - |

| Approach | EB | WB | NB | SB |
|-----------------------|--------|----|----|----|
| HCM Control Delay, \$ | 1430.9 | | 0 | 0 |
| HCM LOS | F | - | | |

| Minor Lane/Major Mvmt | NBL | NBT | NBR | EBLn1 | WBLn1 | SBL | SBT | SBR |
|-----------------------|-------|-----|-----|-----------|-------|-------|-----|-----|
| Capacity (veh/h) | 512 | - | - | 7 | - | 89 | - | - |
| HCM Lane V/C Ratio | 0.004 | - | - | 1.935 | - | 0.012 | - | - |
| HCM Control Delay (s) | 12.1 | - | - | \$ 1430.9 | - | 45.9 | - | - |
| HCM Lane LOS | B | - | - | F | - | E | - | - |
| HCM 95th %tile Q(veh) | 0 | - | - | 2.7 | - | 0 | - | - |

Notes
 ~: Volume exceeds capacity \$: Delay exceeds 300s +: Computation Not Defined *: All major volume in platoon

HCM 6th TWSC
 1: US 23/Cornelia Hwy & Americold Logistics Driveway

2023 AM Peak Hour Build Conditions- RCUT

| Intersection | | | | | | | | | | | | | |
|--------------------------|------|------|------|------|------|------|------|------|------|------|------|------|------|
| Int Delay, s/veh | 2.2 | | | | | | | | | | | | |
| Movement | EBL | EBT | EBR | WBL | WBT | WBR | NBL | NBT | NBR | SBU | SBL | SBT | SBR |
| Lane Configurations | | | ↗ | | | ↗ | ↗ | ↗↗ | | | | ↗↗ | ↗ |
| Traffic Vol, veh/h | 0 | 0 | 25 | 0 | 0 | 160 | 59 | 898 | 35 | 1 | 19 | 2342 | 34 |
| Future Vol, veh/h | 0 | 0 | 25 | 0 | 0 | 160 | 59 | 898 | 35 | 1 | 19 | 2342 | 34 |
| Conflicting Peds, #/hr | 0 | 0 | 0 | 0 | 0 | 0 | 0 | 0 | 0 | 0 | 0 | 0 | 0 |
| Sign Control | Stop | Stop | Stop | Stop | Stop | Stop | Free | Free | Free | Free | Free | Free | Free |
| RT Channelized | - | - | None | - | - | None | - | - | None | - | - | - | None |
| Storage Length | - | - | 0 | - | - | 0 | 475 | - | - | - | - | - | - |
| Veh in Median Storage, # | - | 0 | - | - | 0 | - | - | 0 | - | - | - | 0 | - |
| Grade, % | - | 0 | - | - | 0 | - | - | 0 | - | - | - | 0 | - |
| Peak Hour Factor | 86 | 92 | 86 | 92 | 92 | 92 | 86 | 86 | 92 | 86 | 92 | 86 | 86 |
| Heavy Vehicles, % | 17 | 2 | 17 | 2 | 2 | 2 | 11 | 11 | 2 | 4 | 2 | 4 | 4 |
| Mvmt Flow | 0 | 0 | 29 | 0 | 0 | 174 | 69 | 1044 | 38 | 1 | 21 | 2723 | 40 |

| Major/Minor | Minor2 | | Minor1 | | Major1 | | Major2 | | | | | | |
|----------------------|--------|---|--------|---|--------|------|--------|---|---|------|------|---|---|
| Conflicting Flow All | - | - | 1362 | - | - | 541 | 2763 | 0 | 0 | 1082 | 1082 | 0 | 0 |
| Stage 1 | - | - | - | - | - | - | - | - | - | - | - | - | - |
| Stage 2 | - | - | - | - | - | - | - | - | - | - | - | - | - |
| Critical Hdwy | - | - | 7.24 | - | - | 6.94 | 4.32 | - | - | 6.48 | 4.14 | - | - |
| Critical Hdwy Stg 1 | - | - | - | - | - | - | - | - | - | - | - | - | - |
| Critical Hdwy Stg 2 | - | - | - | - | - | - | - | - | - | - | - | - | - |
| Follow-up Hdwy | - | - | 3.47 | - | - | 3.32 | 2.31 | - | - | 2.54 | 2.22 | - | - |
| Pot Cap-1 Maneuver | 0 | 0 | 120 | 0 | 0 | 485 | 121 | - | - | 289 | 640 | - | - |
| Stage 1 | 0 | 0 | - | 0 | 0 | - | - | - | - | - | - | - | - |
| Stage 2 | 0 | 0 | - | 0 | 0 | - | - | - | - | - | - | - | - |
| Platoon blocked, % | - | - | - | - | - | - | - | - | - | - | - | - | - |
| Mov Cap-1 Maneuver | - | - | 120 | - | - | 485 | 121 | - | - | 570 | 570 | - | - |
| Mov Cap-2 Maneuver | - | - | - | - | - | - | - | - | - | - | - | - | - |
| Stage 1 | - | - | - | - | - | - | - | - | - | - | - | - | - |
| Stage 2 | - | - | - | - | - | - | - | - | - | - | - | - | - |

| Approach | EB | | WB | | NB | | SB | |
|----------------------|------|--|------|--|-----|--|-----|--|
| HCM Control Delay, s | 44.3 | | 16.5 | | 4.1 | | 0.1 | |
| HCM LOS | E | | C | | | | | |

| Minor Lane/Major Mvmt | NBL | NBT | NBR | EBLn1 | WBLn1 | SBL | SBT | SBR |
|-----------------------|-------|-----|-----|-------|-------|-------|-----|-----|
| Capacity (veh/h) | 121 | - | - | 120 | 485 | 570 | - | - |
| HCM Lane V/C Ratio | 0.567 | - | - | 0.242 | 0.359 | 0.036 | - | - |
| HCM Control Delay (s) | 68 | - | - | 44.3 | 16.5 | 11.6 | - | - |
| HCM Lane LOS | F | - | - | E | C | B | - | - |
| HCM 95th %tile Q(veh) | 2.8 | - | - | 0.9 | 1.6 | 0.1 | - | - |

| Intersection | | | | | | |
|--------------------------|------|------|------|------|------|------|
| Int Delay, s/veh | 0 | | | | | |
| Movement | WBL | WBR | NBT | NBR | SBL | SBT |
| Lane Configurations | ↘ | | ↑↑ | | ↘ | ↑↑ |
| Traffic Vol, veh/h | 0 | 0 | 992 | 0 | 6 | 2361 |
| Future Vol, veh/h | 0 | 0 | 992 | 0 | 6 | 2361 |
| Conflicting Peds, #/hr | 0 | 0 | 0 | 0 | 0 | 0 |
| Sign Control | Stop | Stop | Free | Free | Free | Free |
| RT Channelized | - | None | - | None | - | None |
| Storage Length | 0 | - | - | - | 410 | - |
| Veh in Median Storage, # | 0 | - | 0 | - | - | 0 |
| Grade, % | 0 | - | 0 | - | - | 0 |
| Peak Hour Factor | 92 | 92 | 92 | 92 | 92 | 92 |
| Heavy Vehicles, % | 2 | 2 | 2 | 2 | 2 | 2 |
| Mvmt Flow | 0 | 0 | 1078 | 0 | 7 | 2566 |

| Major/Minor | Minor1 | Major1 | Major2 |
|----------------------|--------|--------|--------|
| Conflicting Flow All | 2375 | - | 0 |
| Stage 1 | 1078 | - | - |
| Stage 2 | 1297 | - | - |
| Critical Hdwy | 6.84 | - | - |
| Critical Hdwy Stg 1 | 5.84 | - | - |
| Critical Hdwy Stg 2 | 5.84 | - | - |
| Follow-up Hdwy | 3.52 | - | - |
| Pot Cap-1 Maneuver | 29 | 0 | 0 |
| Stage 1 | 288 | 0 | 0 |
| Stage 2 | 220 | 0 | 0 |
| Platoon blocked, % | | - | - |
| Mov Cap-1 Maneuver | 29 | - | - |
| Mov Cap-2 Maneuver | 29 | - | - |
| Stage 1 | 288 | - | - |
| Stage 2 | 218 | - | - |

| Approach | WB | NB | SB |
|----------------------|----|----|----|
| HCM Control Delay, s | 0 | 0 | 0 |
| HCM LOS | A | | |

| Minor Lane/Major Mvmt | NBTWBLn1 | SBL | SBT |
|-----------------------|----------|-----|------|
| Capacity (veh/h) | - | - | 643 |
| HCM Lane V/C Ratio | - | - | 0.01 |
| HCM Control Delay (s) | - | 0 | 10.7 |
| HCM Lane LOS | - | A | B |
| HCM 95th %tile Q(veh) | - | - | 0 |

| Intersection | | | | | | |
|--------------------------|------|------|------|------|------|------|
| Int Delay, s/veh | 2 | | | | | |
| Movement | EBL | EBR | NBL | NBT | SBT | SBR |
| Lane Configurations | | ↗ | ↘ | ↑↑ | ↑↑ | |
| Traffic Vol, veh/h | 0 | 0 | 105 | 954 | 2396 | 0 |
| Future Vol, veh/h | 0 | 0 | 105 | 954 | 2396 | 0 |
| Conflicting Peds, #/hr | 0 | 0 | 0 | 0 | 0 | 0 |
| Sign Control | Stop | Stop | Free | Free | Free | Free |
| RT Channelized | - | None | - | None | - | None |
| Storage Length | - | 0 | 410 | - | - | - |
| Veh in Median Storage, # | 0 | - | - | 0 | 0 | - |
| Grade, % | 0 | - | - | 0 | 0 | - |
| Peak Hour Factor | 92 | 92 | 92 | 92 | 92 | 92 |
| Heavy Vehicles, % | 2 | 2 | 2 | 2 | 2 | 2 |
| Mvmt Flow | 0 | 0 | 114 | 1037 | 2604 | 0 |

| Major/Minor | Minor2 | Major1 | Major2 | | | |
|----------------------|--------|--------|--------|---|---|---|
| Conflicting Flow All | - | 1302 | 2604 | 0 | - | 0 |
| Stage 1 | - | - | - | - | - | - |
| Stage 2 | - | - | - | - | - | - |
| Critical Hdwy | - | 6.94 | 4.14 | - | - | - |
| Critical Hdwy Stg 1 | - | - | - | - | - | - |
| Critical Hdwy Stg 2 | - | - | - | - | - | - |
| Follow-up Hdwy | - | 3.32 | 2.22 | - | - | - |
| Pot Cap-1 Maneuver | 0 | 151 | 163 | - | - | 0 |
| Stage 1 | 0 | - | - | - | - | 0 |
| Stage 2 | 0 | - | - | - | - | 0 |
| Platoon blocked, % | | | | - | - | |
| Mov Cap-1 Maneuver | - | 151 | 163 | - | - | - |
| Mov Cap-2 Maneuver | - | - | - | - | - | - |
| Stage 1 | - | - | - | - | - | - |
| Stage 2 | - | - | - | - | - | - |

| Approach | EB | NB | SB |
|----------------------|----|-----|----|
| HCM Control Delay, s | 0 | 6.6 | 0 |
| HCM LOS | A | | |

| Minor Lane/Major Mvmt | NBL | NBT | EBLn1 | SBT |
|-----------------------|------|-----|-------|-----|
| Capacity (veh/h) | 163 | - | - | - |
| HCM Lane V/C Ratio | 0.7 | - | - | - |
| HCM Control Delay (s) | 66.9 | - | 0 | - |
| HCM Lane LOS | F | - | A | - |
| HCM 95th %tile Q(veh) | 4.2 | - | - | - |

HCM 6th TWSC
 1: US 23/Cornelia Hwy & Americold Logistics Driveway

2023 PM Peak Hour Build Conditions- RCUT

| Intersection | | | | | | | | | | | | |
|--------------------------|------|------|------|------|------|------|------|------|------|------|------|------|
| Int Delay, s/veh | 4.5 | | | | | | | | | | | |
| Movement | EBL | EBT | EBR | WBL | WBT | WBR | NBL | NBT | NBR | SBL | SBT | SBR |
| Lane Configurations | | | ↗ | | | ↗ | ↗ | ↗↗ | | | ↗↗ | ↗ |
| Traffic Vol, veh/h | 0 | 0 | 46 | 0 | 0 | 105 | 6 | 2575 | 110 | 70 | 1134 | 8 |
| Future Vol, veh/h | 0 | 0 | 46 | 0 | 0 | 105 | 6 | 2575 | 110 | 70 | 1134 | 8 |
| Conflicting Peds, #/hr | 0 | 0 | 0 | 0 | 0 | 0 | 0 | 0 | 0 | 0 | 0 | 0 |
| Sign Control | Stop | Stop | Stop | Stop | Stop | Stop | Free | Free | Free | Free | Free | Free |
| RT Channelized | - | - | None | - | - | None | - | - | None | - | - | None |
| Storage Length | - | - | 0 | - | - | 0 | 475 | - | - | - | - | - |
| Veh in Median Storage, # | - | 0 | - | - | 0 | - | - | 0 | - | - | 0 | - |
| Grade, % | - | 0 | - | - | 0 | - | - | 0 | - | - | 0 | - |
| Peak Hour Factor | 95 | 92 | 95 | 92 | 92 | 92 | 95 | 95 | 92 | 92 | 95 | 95 |
| Heavy Vehicles, % | 19 | 2 | 19 | 2 | 2 | 2 | 4 | 4 | 2 | 2 | 8 | 8 |
| Mvmt Flow | 0 | 0 | 48 | 0 | 0 | 114 | 6 | 2711 | 120 | 76 | 1194 | 8 |

| Major/Minor | Minor2 | | Minor1 | | Major1 | | Major2 | | | | | |
|----------------------|--------|---|--------|---|--------|------|--------|---|---|------|---|---|
| Conflicting Flow All | - | - | 597 | - | - | 1416 | 1202 | 0 | 0 | 2831 | 0 | 0 |
| Stage 1 | - | - | - | - | - | - | - | - | - | - | - | - |
| Stage 2 | - | - | - | - | - | - | - | - | - | - | - | - |
| Critical Hdwy | - | - | 7.28 | - | - | 6.94 | 4.18 | - | - | 4.14 | - | - |
| Critical Hdwy Stg 1 | - | - | - | - | - | - | - | - | - | - | - | - |
| Critical Hdwy Stg 2 | - | - | - | - | - | - | - | - | - | - | - | - |
| Follow-up Hdwy | - | - | 3.49 | - | - | 3.32 | 2.24 | - | - | 2.22 | - | - |
| Pot Cap-1 Maneuver | 0 | 0 | 406 | 0 | 0 | 127 | 565 | - | - | 132 | - | - |
| Stage 1 | 0 | 0 | - | 0 | 0 | - | - | - | - | - | - | - |
| Stage 2 | 0 | 0 | - | 0 | 0 | - | - | - | - | - | - | - |
| Platoon blocked, % | - | - | - | - | - | - | - | - | - | - | - | - |
| Mov Cap-1 Maneuver | - | - | 406 | - | - | 127 | 565 | - | - | 132 | - | - |
| Mov Cap-2 Maneuver | - | - | - | - | - | - | - | - | - | - | - | - |
| Stage 1 | - | - | - | - | - | - | - | - | - | - | - | - |
| Stage 2 | - | - | - | - | - | - | - | - | - | - | - | - |

| Approach | EB | | WB | | NB | | SB | |
|----------------------|------|--|-----|--|----|--|-----|--|
| HCM Control Delay, s | 15.1 | | 120 | | 0 | | 3.8 | |
| HCM LOS | C | | F | | | | | |

| Minor Lane/Major Mvmt | NBL | NBT | NBR | EBLn1 | WBLn1 | SBL | SBT | SBR |
|-----------------------|-------|-----|-----|-------|-------|-------|-----|-----|
| Capacity (veh/h) | 565 | - | - | 406 | 127 | 132 | - | - |
| HCM Lane V/C Ratio | 0.011 | - | - | 0.119 | 0.899 | 0.576 | - | - |
| HCM Control Delay (s) | 11.4 | - | - | 15.1 | 120 | 64.1 | - | - |
| HCM Lane LOS | B | - | - | C | F | F | - | - |
| HCM 95th %tile Q(veh) | 0 | - | - | 0.4 | 5.8 | 2.9 | - | - |

HCM 6th TWSC
 1: US 23/Cornelia Hwy & Americold Logistics Driveway

2028 AM Peak Hour Build Conditions- RCUT

| Intersection | | | | | | | | | | | | | |
|--------------------------|------|------|------|------|------|------|------|------|------|------|------|------|------|
| Int Delay, s/veh | 4.8 | | | | | | | | | | | | |
| Movement | EBL | EBT | EBR | WBL | WBT | WBR | NBL | NBT | NBR | SBU | SBL | SBT | SBR |
| Lane Configurations | | | ↗ | | | ↗ | ↗ | ↗↗ | | | | ↗↗ | ↗ |
| Traffic Vol, veh/h | 0 | 0 | 29 | 0 | 0 | 160 | 69 | 1054 | 35 | 1 | 19 | 2730 | 40 |
| Future Vol, veh/h | 0 | 0 | 29 | 0 | 0 | 160 | 69 | 1054 | 35 | 1 | 19 | 2730 | 40 |
| Conflicting Peds, #/hr | 0 | 0 | 0 | 0 | 0 | 0 | 0 | 0 | 0 | 0 | 0 | 0 | 0 |
| Sign Control | Stop | Stop | Stop | Stop | Stop | Stop | Free | Free | Free | Free | Free | Free | Free |
| RT Channelized | - | - | None | - | - | None | - | - | None | - | - | - | None |
| Storage Length | - | - | 0 | - | - | 0 | 475 | - | - | - | - | - | - |
| Veh in Median Storage, # | - | 0 | - | - | 0 | - | - | 0 | - | - | - | 0 | - |
| Grade, % | - | 0 | - | - | 0 | - | - | 0 | - | - | - | 0 | - |
| Peak Hour Factor | 86 | 92 | 86 | 92 | 92 | 92 | 86 | 86 | 92 | 86 | 92 | 86 | 86 |
| Heavy Vehicles, % | 17 | 2 | 17 | 2 | 2 | 2 | 11 | 11 | 2 | 4 | 2 | 4 | 4 |
| Mvmt Flow | 0 | 0 | 34 | 0 | 0 | 174 | 80 | 1226 | 38 | 1 | 21 | 3174 | 47 |

| Major/Minor | Minor2 | | Minor1 | | Major1 | | | Major2 | | | | | |
|----------------------|--------|---|--------|---|--------|------|------|--------|---|------|------|---|---|
| Conflicting Flow All | - | - | 1587 | - | - | 632 | 3221 | 0 | 0 | 1264 | 1264 | 0 | 0 |
| Stage 1 | - | - | - | - | - | - | - | - | - | - | - | - | - |
| Stage 2 | - | - | - | - | - | - | - | - | - | - | - | - | - |
| Critical Hdwy | - | - | 7.24 | - | - | 6.94 | 4.32 | - | - | 6.48 | 4.14 | - | - |
| Critical Hdwy Stg 1 | - | - | - | - | - | - | - | - | - | - | - | - | - |
| Critical Hdwy Stg 2 | - | - | - | - | - | - | - | - | - | - | - | - | - |
| Follow-up Hdwy | - | - | 3.47 | - | - | 3.32 | 2.31 | - | - | 2.54 | 2.22 | - | - |
| Pot Cap-1 Maneuver | 0 | 0 | 83 | 0 | 0 | 423 | ~77 | - | - | 220 | 546 | - | - |
| Stage 1 | 0 | 0 | - | 0 | 0 | - | - | - | - | - | - | - | - |
| Stage 2 | 0 | 0 | - | 0 | 0 | - | - | - | - | - | - | - | - |
| Platoon blocked, % | - | - | - | - | - | - | - | - | - | - | - | - | - |
| Mov Cap-1 Maneuver | - | - | 83 | - | - | 423 | ~77 | - | - | 471 | 471 | - | - |
| Mov Cap-2 Maneuver | - | - | - | - | - | - | - | - | - | - | - | - | - |
| Stage 1 | - | - | - | - | - | - | - | - | - | - | - | - | - |
| Stage 2 | - | - | - | - | - | - | - | - | - | - | - | - | - |

| Approach | EB | | WB | | NB | | | SB | | | |
|----------------------|------|--|------|--|------|--|--|-----|--|--|--|
| HCM Control Delay, s | 75.3 | | 19.3 | | 12.5 | | | 0.1 | | | |
| HCM LOS | F | | C | | | | | | | | |

| Minor Lane/Major Mvmt | NBL | NBT | NBR | EBLn1 | WBLn1 | SBL | SBT | SBR |
|-----------------------|-------|-----|-----|-------|-------|-------|-----|-----|
| Capacity (veh/h) | ~77 | - | - | 83 | 423 | 471 | - | - |
| HCM Lane V/C Ratio | 1.042 | - | - | 0.406 | 0.411 | 0.044 | - | - |
| HCM Control Delay (s) | 209.6 | - | - | 75.3 | 19.3 | 13 | - | - |
| HCM Lane LOS | F | - | - | F | C | B | - | - |
| HCM 95th %tile Q(veh) | 5.7 | - | - | 1.6 | 2 | 0.1 | - | - |

Notes
 ~: Volume exceeds capacity \$: Delay exceeds 300s +: Computation Not Defined *: All major volume in platoon

| Intersection | | | | | | |
|--------------------------|------|------|------|------|------|------|
| Int Delay, s/veh | 0 | | | | | |
| Movement | WBL | WBR | NBT | NBR | SBL | SBT |
| Lane Configurations | ↘ | | ↑↑ | | ↘ | ↑↑ |
| Traffic Vol, veh/h | 0 | 0 | 1158 | 0 | 7 | 2752 |
| Future Vol, veh/h | 0 | 0 | 1158 | 0 | 7 | 2752 |
| Conflicting Peds, #/hr | 0 | 0 | 0 | 0 | 0 | 0 |
| Sign Control | Stop | Stop | Free | Free | Free | Free |
| RT Channelized | - | None | - | None | - | None |
| Storage Length | 0 | - | - | - | 410 | - |
| Veh in Median Storage, # | 0 | - | 0 | - | - | 0 |
| Grade, % | 0 | - | 0 | - | - | 0 |
| Peak Hour Factor | 92 | 92 | 92 | 92 | 92 | 92 |
| Heavy Vehicles, % | 2 | 2 | 2 | 2 | 2 | 2 |
| Mvmt Flow | 0 | 0 | 1259 | 0 | 8 | 2991 |

| Major/Minor | Minor1 | Major1 | Major2 | | |
|----------------------|--------|--------|--------|---|--------|
| Conflicting Flow All | 2771 | - | 0 | - | 1259 0 |
| Stage 1 | 1259 | - | - | - | - |
| Stage 2 | 1512 | - | - | - | - |
| Critical Hdwy | 6.84 | - | - | - | 4.14 - |
| Critical Hdwy Stg 1 | 5.84 | - | - | - | - |
| Critical Hdwy Stg 2 | 5.84 | - | - | - | - |
| Follow-up Hdwy | 3.52 | - | - | - | 2.22 - |
| Pot Cap-1 Maneuver | 15 | 0 | - | 0 | 548 - |
| Stage 1 | 231 | 0 | - | 0 | - - |
| Stage 2 | 169 | 0 | - | 0 | - - |
| Platoon blocked, % | | | | | |
| Mov Cap-1 Maneuver | 15 | - | - | - | 548 - |
| Mov Cap-2 Maneuver | 15 | - | - | - | - - |
| Stage 1 | 231 | - | - | - | - - |
| Stage 2 | 166 | - | - | - | - - |

| Approach | WB | NB | SB |
|----------------------|----|----|----|
| HCM Control Delay, s | 0 | 0 | 0 |
| HCM LOS | A | | |

| Minor Lane/Major Mvmt | NBTWBLn1 | SBL | SBT |
|-----------------------|----------|-----|---------|
| Capacity (veh/h) | - | - | 548 - |
| HCM Lane V/C Ratio | - | - | 0.014 - |
| HCM Control Delay (s) | - | 0 | 11.7 - |
| HCM Lane LOS | - | A | B - |
| HCM 95th %tile Q(veh) | - | - | 0 - |

| Intersection | | | | | | |
|--------------------------|------|------|------|------|------|------|
| Int Delay, s/veh | 4.5 | | | | | |
| Movement | EBL | EBR | NBL | NBT | SBT | SBR |
| Lane Configurations | | ↗ | ↘ | ↑↑ | ↑↑ | |
| Traffic Vol, veh/h | 0 | 0 | 105 | 1110 | 2790 | 0 |
| Future Vol, veh/h | 0 | 0 | 105 | 1110 | 2790 | 0 |
| Conflicting Peds, #/hr | 0 | 0 | 0 | 0 | 0 | 0 |
| Sign Control | Stop | Stop | Free | Free | Free | Free |
| RT Channelized | - | None | - | None | - | None |
| Storage Length | - | 0 | 410 | - | - | - |
| Veh in Median Storage, # | 0 | - | - | 0 | 0 | - |
| Grade, % | 0 | - | - | 0 | 0 | - |
| Peak Hour Factor | 92 | 92 | 92 | 92 | 92 | 92 |
| Heavy Vehicles, % | 2 | 2 | 2 | 2 | 2 | 2 |
| Mvmt Flow | 0 | 0 | 114 | 1207 | 3033 | 0 |

| Major/Minor | Minor2 | Major1 | Major2 | | | |
|----------------------|--------|-----------|--------|---|---|---|
| Conflicting Flow All | - | 1517 | 3033 | 0 | - | 0 |
| Stage 1 | - | - | - | - | - | - |
| Stage 2 | - | - | - | - | - | - |
| Critical Hdwy | - | 6.94 | 4.14 | - | - | - |
| Critical Hdwy Stg 1 | - | - | - | - | - | - |
| Critical Hdwy Stg 2 | - | - | - | - | - | - |
| Follow-up Hdwy | - | 3.32 | 2.22 | - | - | - |
| Pot Cap-1 Maneuver | 0 | 108 ~ 110 | - | - | - | 0 |
| Stage 1 | 0 | - | - | - | - | 0 |
| Stage 2 | 0 | - | - | - | - | 0 |
| Platoon blocked, % | | | | - | - | |
| Mov Cap-1 Maneuver | - | 108 ~ 110 | - | - | - | - |
| Mov Cap-2 Maneuver | - | - | - | - | - | - |
| Stage 1 | - | - | - | - | - | - |
| Stage 2 | - | - | - | - | - | - |

| Approach | EB | NB | SB |
|----------------------|----|------|----|
| HCM Control Delay, s | 0 | 14.7 | 0 |
| HCM LOS | A | | |

| Minor Lane/Major Mvmt | NBL | NBT | EBLn1 | SBT |
|-----------------------|-------|-----|-------|-----|
| Capacity (veh/h) | ~ 110 | - | - | - |
| HCM Lane V/C Ratio | 1.038 | - | - | - |
| HCM Control Delay (s) | 170.1 | - | 0 | - |
| HCM Lane LOS | F | - | A | - |
| HCM 95th %tile Q(veh) | 6.8 | - | - | - |

Notes
 ~: Volume exceeds capacity \$: Delay exceeds 300s +: Computation Not Defined *: All major volume in platoon

HCM 6th TWSC
 1: US 23/Cornelia Hwy & Americold Logistics Driveway

2028 PM Peak Hour Build Conditions- RCUT

| Intersection | | | | | | | | | | | | |
|--------------------------|------|------|------|------|------|------|------|------|------|------|------|------|
| Int Delay, s/veh | 9.1 | | | | | | | | | | | |
| Movement | EBL | EBT | EBR | WBL | WBT | WBR | NBL | NBT | NBR | SBL | SBT | SBR |
| Lane Configurations | | | ↗ | | | ↗ | ↗ | ↗↗ | | | ↗↗ | ↗ |
| Traffic Vol, veh/h | 0 | 0 | 54 | 0 | 0 | 105 | 7 | 3021 | 110 | 70 | 1329 | 9 |
| Future Vol, veh/h | 0 | 0 | 54 | 0 | 0 | 105 | 7 | 3021 | 110 | 70 | 1329 | 9 |
| Conflicting Peds, #/hr | 0 | 0 | 0 | 0 | 0 | 0 | 0 | 0 | 0 | 0 | 0 | 0 |
| Sign Control | Stop | Stop | Stop | Stop | Stop | Stop | Free | Free | Free | Free | Free | Free |
| RT Channelized | - | - | None | - | - | None | - | - | None | - | - | None |
| Storage Length | - | - | 0 | - | - | 0 | 475 | - | - | - | - | - |
| Veh in Median Storage, # | - | 0 | - | - | 0 | - | - | 0 | - | - | 0 | - |
| Grade, % | - | 0 | - | - | 0 | - | - | 0 | - | - | 0 | - |
| Peak Hour Factor | 95 | 92 | 95 | 92 | 92 | 92 | 95 | 95 | 92 | 92 | 95 | 95 |
| Heavy Vehicles, % | 19 | 2 | 19 | 2 | 2 | 2 | 4 | 4 | 2 | 2 | 8 | 8 |
| Mvmt Flow | 0 | 0 | 57 | 0 | 0 | 114 | 7 | 3180 | 120 | 76 | 1399 | 9 |

| Major/Minor | Minor2 | | Minor1 | | Major1 | | Major2 | | | | | |
|----------------------|--------|---|--------|---|--------|------|--------|---|---|------|---|---|
| Conflicting Flow All | - | - | 700 | - | - | 1650 | 1408 | 0 | 0 | 3300 | 0 | 0 |
| Stage 1 | - | - | - | - | - | - | - | - | - | - | - | - |
| Stage 2 | - | - | - | - | - | - | - | - | - | - | - | - |
| Critical Hdwy | - | - | 7.28 | - | - | 6.94 | 4.18 | - | - | 4.14 | - | - |
| Critical Hdwy Stg 1 | - | - | - | - | - | - | - | - | - | - | - | - |
| Critical Hdwy Stg 2 | - | - | - | - | - | - | - | - | - | - | - | - |
| Follow-up Hdwy | - | - | 3.49 | - | - | 3.32 | 2.24 | - | - | 2.22 | - | - |
| Pot Cap-1 Maneuver | 0 | 0 | 345 | 0 | 0 | ~ 88 | 470 | - | - | 85 | - | - |
| Stage 1 | 0 | 0 | - | 0 | 0 | - | - | - | - | - | - | - |
| Stage 2 | 0 | 0 | - | 0 | 0 | - | - | - | - | - | - | - |
| Platoon blocked, % | - | - | - | - | - | - | - | - | - | - | - | - |
| Mov Cap-1 Maneuver | - | - | 345 | - | - | ~ 88 | 470 | - | - | 85 | - | - |
| Mov Cap-2 Maneuver | - | - | - | - | - | - | - | - | - | - | - | - |
| Stage 1 | - | - | - | - | - | - | - | - | - | - | - | - |
| Stage 2 | - | - | - | - | - | - | - | - | - | - | - | - |

| Approach | EB | | WB | | NB | | SB | | |
|----------------------|------|--|-------|--|----|--|----|--|--|
| HCM Control Delay, s | 17.5 | | 281.1 | | 0 | | 8 | | |
| HCM LOS | C | | F | | | | | | |

| Minor Lane/Major Mvmt | NBL | NBT | NBR | EBLn1 | WBLn1 | SBL | SBT | SBR |
|-----------------------|-------|-----|-----|-------|-------|-------|-----|-----|
| Capacity (veh/h) | 470 | - | - | 345 | 88 | 85 | - | - |
| HCM Lane V/C Ratio | 0.016 | - | - | 0.165 | 1.297 | 0.895 | - | - |
| HCM Control Delay (s) | 12.8 | - | - | 17.5 | 281.1 | 156.5 | - | - |
| HCM Lane LOS | B | - | - | C | F | F | - | - |
| HCM 95th %tile Q(veh) | 0 | - | - | 0.6 | 8.4 | 4.8 | - | - |

Notes
 ~: Volume exceeds capacity \$: Delay exceeds 300s +: Computation Not Defined *: All major volume in platoon

| Intersection | | | | | | |
|--------------------------|------|------|------|------|------|------|
| Int Delay, s/veh | 4.4 | | | | | |
| Movement | EBT | EBR | WBL | WBT | NBL | NBR |
| Lane Configurations | | | | | | |
| Traffic Vol, veh/h | 3 | 6 | 2 | 7 | 14 | 1 |
| Future Vol, veh/h | 3 | 6 | 2 | 7 | 14 | 1 |
| Conflicting Peds, #/hr | 0 | 0 | 0 | 0 | 0 | 0 |
| Sign Control | Free | Free | Free | Free | Stop | Stop |
| RT Channelized | - | None | - | None | - | None |
| Storage Length | - | - | - | - | 0 | - |
| Veh in Median Storage, # | 0 | - | - | 0 | 0 | - |
| Grade, % | 0 | - | - | 0 | 0 | - |
| Peak Hour Factor | 62 | 62 | 62 | 62 | 62 | 62 |
| Heavy Vehicles, % | 0 | 0 | 0 | 0 | 0 | 0 |
| Mvmt Flow | 5 | 10 | 3 | 11 | 23 | 2 |

| Major/Minor | Major1 | Major2 | Minor1 | Minor2 | Minor3 |
|----------------------|--------|--------|--------|--------|--------|
| Conflicting Flow All | 0 | 0 | 15 | 0 | 27 |
| Stage 1 | - | - | - | - | 10 |
| Stage 2 | - | - | - | - | 17 |
| Critical Hdwy | - | - | 4.1 | - | 6.4 |
| Critical Hdwy Stg 1 | - | - | - | - | 5.4 |
| Critical Hdwy Stg 2 | - | - | - | - | 5.4 |
| Follow-up Hdwy | - | - | 2.2 | - | 3.5 |
| Pot Cap-1 Maneuver | - | - | 1616 | - | 993 |
| Stage 1 | - | - | - | - | 1018 |
| Stage 2 | - | - | - | - | 1011 |
| Platoon blocked, % | - | - | - | - | - |
| Mov Cap-1 Maneuver | - | - | 1616 | - | 991 |
| Mov Cap-2 Maneuver | - | - | - | - | 991 |
| Stage 1 | - | - | - | - | 1018 |
| Stage 2 | - | - | - | - | 1009 |

| Approach | EB | WB | NB |
|----------------------|----|-----|-----|
| HCM Control Delay, s | 0 | 1.6 | 8.7 |
| HCM LOS | | | A |

| Minor Lane/Major Mvmt | NBLn1 | EBT | EBR | WBL | WBT |
|-----------------------|-------|-----|-----|-------|-----|
| Capacity (veh/h) | 996 | - | - | 1616 | - |
| HCM Lane V/C Ratio | 0.024 | - | - | 0.002 | - |
| HCM Control Delay (s) | 8.7 | - | - | 7.2 | 0 |
| HCM Lane LOS | A | - | - | A | A |
| HCM 95th %tile Q(veh) | 0.1 | - | - | 0 | - |

| Intersection | | | | | | |
|--------------------------|------|------|------|------|------|------|
| Int Delay, s/veh | 3.1 | | | | | |
| Movement | EBL | EBR | NBL | NBT | SBT | SBR |
| Lane Configurations | | | | | | |
| Traffic Vol, veh/h | 10 | 0 | 2 | 11 | 5 | 5 |
| Future Vol, veh/h | 10 | 0 | 2 | 11 | 5 | 5 |
| Conflicting Peds, #/hr | 0 | 0 | 0 | 0 | 0 | 0 |
| Sign Control | Stop | Stop | Free | Free | Free | Free |
| RT Channelized | - | None | - | None | - | None |
| Storage Length | 0 | - | - | - | - | - |
| Veh in Median Storage, # | 0 | - | - | 0 | 0 | - |
| Grade, % | 0 | - | - | 0 | 0 | - |
| Peak Hour Factor | 72 | 72 | 72 | 72 | 72 | 72 |
| Heavy Vehicles, % | 0 | 0 | 0 | 0 | 0 | 0 |
| Mvmt Flow | 14 | 0 | 3 | 15 | 7 | 7 |

| Major/Minor | Minor2 | Major1 | | Major2 | |
|----------------------|--------|--------|------|--------|---|
| Conflicting Flow All | 32 | 11 | 14 | 0 | 0 |
| Stage 1 | 11 | - | - | - | - |
| Stage 2 | 21 | - | - | - | - |
| Critical Hdwy | 6.4 | 6.2 | 4.1 | - | - |
| Critical Hdwy Stg 1 | 5.4 | - | - | - | - |
| Critical Hdwy Stg 2 | 5.4 | - | - | - | - |
| Follow-up Hdwy | 3.5 | 3.3 | 2.2 | - | - |
| Pot Cap-1 Maneuver | 987 | 1076 | 1617 | - | - |
| Stage 1 | 1017 | - | - | - | - |
| Stage 2 | 1007 | - | - | - | - |
| Platoon blocked, % | | | | - | - |
| Mov Cap-1 Maneuver | 985 | 1076 | 1617 | - | - |
| Mov Cap-2 Maneuver | 985 | - | - | - | - |
| Stage 1 | 1015 | - | - | - | - |
| Stage 2 | 1007 | - | - | - | - |

| Approach | EB | NB | SB |
|----------------------|-----|-----|----|
| HCM Control Delay, s | 8.7 | 1.1 | 0 |
| HCM LOS | A | | |

| Minor Lane/Major Mvmt | NBL | NBT | EBLn1 | SBT | SBR |
|-----------------------|-------|-----|-------|-----|-----|
| Capacity (veh/h) | 1617 | - | 985 | - | - |
| HCM Lane V/C Ratio | 0.002 | - | 0.014 | - | - |
| HCM Control Delay (s) | 7.2 | 0 | 8.7 | - | - |
| HCM Lane LOS | A | A | A | - | - |
| HCM 95th %tile Q(veh) | 0 | - | 0 | - | - |

HCM 6th TWSC
4: Noah Martin Rd & Whitehall Rd

2023 AM Peak Hour Build Conditions

| Intersection | | | | | | | | | | | | |
|--------------------------|------|------|------|------|------|------|------|------|------|------|------|------|
| Int Delay, s/veh | 5.5 | | | | | | | | | | | |
| Movement | EBL | EBT | EBR | WBL | WBT | WBR | NBL | NBT | NBR | SBL | SBT | SBR |
| Lane Configurations | | ↕ | | | ↕ | | | ↕ | | | ↕ | |
| Traffic Vol, veh/h | 2 | 5 | 2 | 0 | 18 | 4 | 1 | 2 | 1 | 2 | 15 | 4 |
| Future Vol, veh/h | 2 | 5 | 2 | 0 | 18 | 4 | 1 | 2 | 1 | 2 | 15 | 4 |
| Conflicting Peds, #/hr | 0 | 0 | 0 | 0 | 0 | 0 | 0 | 0 | 0 | 0 | 0 | 0 |
| Sign Control | Stop | Stop | Stop | Stop | Stop | Stop | Free | Free | Free | Free | Free | Free |
| RT Channelized | - | - | None | - | - | None | - | - | None | - | - | None |
| Storage Length | - | - | - | - | - | - | - | - | - | - | - | - |
| Veh in Median Storage, # | - | 0 | - | - | 0 | - | - | 0 | - | - | 0 | - |
| Grade, % | - | 0 | - | - | 0 | - | - | 0 | - | - | 0 | - |
| Peak Hour Factor | 79 | 79 | 79 | 79 | 79 | 79 | 79 | 79 | 79 | 79 | 79 | 79 |
| Heavy Vehicles, % | 14 | 14 | 14 | 6 | 6 | 6 | 33 | 33 | 33 | 10 | 10 | 10 |
| Mvmt Flow | 3 | 6 | 3 | 0 | 23 | 5 | 1 | 3 | 1 | 3 | 19 | 5 |

| Major/Minor | Minor2 | | Minor1 | | Major1 | | | Major2 | | | | |
|----------------------|--------|-------|--------|-------|--------|-------|-------|--------|---|------|---|---|
| Conflicting Flow All | 48 | 34 | 22 | 38 | 36 | 4 | 24 | 0 | 0 | 4 | 0 | 0 |
| Stage 1 | 28 | 28 | - | 6 | 6 | - | - | - | - | - | - | - |
| Stage 2 | 20 | 6 | - | 32 | 30 | - | - | - | - | - | - | - |
| Critical Hdwy | 7.24 | 6.64 | 6.34 | 7.16 | 6.56 | 6.26 | 4.43 | - | - | 4.2 | - | - |
| Critical Hdwy Stg 1 | 6.24 | 5.64 | - | 6.16 | 5.56 | - | - | - | - | - | - | - |
| Critical Hdwy Stg 2 | 6.24 | 5.64 | - | 6.16 | 5.56 | - | - | - | - | - | - | - |
| Follow-up Hdwy | 3.626 | 4.126 | 3.426 | 3.554 | 4.054 | 3.354 | 2.497 | - | - | 2.29 | - | - |
| Pot Cap-1 Maneuver | 923 | 836 | 1021 | 957 | 849 | 1068 | 1411 | - | - | 1567 | - | - |
| Stage 1 | 959 | 849 | - | 1006 | 883 | - | - | - | - | - | - | - |
| Stage 2 | 969 | 867 | - | 974 | 862 | - | - | - | - | - | - | - |
| Platoon blocked, % | | | | | | | | - | - | - | - | - |
| Mov Cap-1 Maneuver | 898 | 833 | 1021 | 946 | 846 | 1068 | 1411 | - | - | 1567 | - | - |
| Mov Cap-2 Maneuver | 898 | 833 | - | 946 | 846 | - | - | - | - | - | - | - |
| Stage 1 | 958 | 847 | - | 1005 | 882 | - | - | - | - | - | - | - |
| Stage 2 | 939 | 866 | - | 962 | 860 | - | - | - | - | - | - | - |

| Approach | EB | | WB | | NB | | SB | |
|----------------------|-----|--|-----|--|-----|--|-----|--|
| HCM Control Delay, s | 9.1 | | 9.2 | | 1.9 | | 0.7 | |
| HCM LOS | A | | A | | | | | |

| Minor Lane/Major Mvmt | NBL | NBT | NBR | EBLn1 | WBLn1 | SBL | SBT | SBR |
|-----------------------|-------|-----|-----|-------|-------|-------|-----|-----|
| Capacity (veh/h) | 1411 | - | - | 883 | 879 | 1567 | - | - |
| HCM Lane V/C Ratio | 0.001 | - | - | 0.013 | 0.032 | 0.002 | - | - |
| HCM Control Delay (s) | 7.6 | 0 | - | 9.1 | 9.2 | 7.3 | 0 | - |
| HCM Lane LOS | A | A | - | A | A | A | A | - |
| HCM 95th %tile Q(veh) | 0 | - | - | 0 | 0.1 | 0 | - | - |

| Intersection | | | | | | |
|--------------------------|------|------|------|------|------|------|
| Int Delay, s/veh | 0.4 | | | | | |
| Movement | EBL | EBT | WBT | WBR | SBL | SBR |
| Lane Configurations | | ↶ | ↷ | | ↶ | |
| Traffic Vol, veh/h | 0 | 85 | 385 | 3 | 2 | 14 |
| Future Vol, veh/h | 0 | 85 | 385 | 3 | 2 | 14 |
| Conflicting Peds, #/hr | 0 | 0 | 0 | 0 | 0 | 0 |
| Sign Control | Free | Free | Free | Free | Stop | Stop |
| RT Channelized | - | None | - | None | - | None |
| Storage Length | - | - | - | - | 0 | - |
| Veh in Median Storage, # | - | 0 | 0 | - | 0 | - |
| Grade, % | - | 0 | 0 | - | 0 | - |
| Peak Hour Factor | 89 | 89 | 89 | 89 | 89 | 89 |
| Heavy Vehicles, % | 9 | 9 | 3 | 3 | 13 | 13 |
| Mvmt Flow | 0 | 96 | 433 | 3 | 2 | 16 |

| Major/Minor | Major1 | Major2 | Minor2 | | |
|----------------------|--------|--------|--------|---|-------------|
| Conflicting Flow All | 436 | 0 | - | 0 | 531 435 |
| Stage 1 | - | - | - | - | 435 - |
| Stage 2 | - | - | - | - | 96 - |
| Critical Hdwy | 4.19 | - | - | - | 6.53 6.33 |
| Critical Hdwy Stg 1 | - | - | - | - | 5.53 - |
| Critical Hdwy Stg 2 | - | - | - | - | 5.53 - |
| Follow-up Hdwy | 2.281 | - | - | - | 3.617 3.417 |
| Pot Cap-1 Maneuver | 1087 | - | - | - | 490 598 |
| Stage 1 | - | - | - | - | 630 - |
| Stage 2 | - | - | - | - | 901 - |
| Platoon blocked, % | | - | - | - | |
| Mov Cap-1 Maneuver | 1087 | - | - | - | 490 598 |
| Mov Cap-2 Maneuver | - | - | - | - | 490 - |
| Stage 1 | - | - | - | - | 630 - |
| Stage 2 | - | - | - | - | 901 - |

| Approach | EB | WB | SB |
|----------------------|----|----|------|
| HCM Control Delay, s | 0 | 0 | 11.4 |
| HCM LOS | | | B |

| Minor Lane/Major Mvmt | EBL | EBT | WBT | WBR | SBLn1 |
|-----------------------|------|-----|-----|-----|-------|
| Capacity (veh/h) | 1087 | - | - | - | 582 |
| HCM Lane V/C Ratio | - | - | - | - | 0.031 |
| HCM Control Delay (s) | 0 | - | - | - | 11.4 |
| HCM Lane LOS | A | - | - | - | B |
| HCM 95th %tile Q(veh) | 0 | - | - | - | 0.1 |

| Intersection | | | | | | | | | | | | |
|--------------------------|------|------|------|------|------|------|------|------|------|------|------|------|
| Int Delay, s/veh | 13.3 | | | | | | | | | | | |
| Movement | EBL | EBT | EBR | WBL | WBT | WBR | NBL | NBT | NBR | SBL | SBT | SBR |
| Lane Configurations | | ↕ | | | ↕ | | ↕ | ↑↑ | ↕ | ↕ | ↑↑ | ↕ |
| Traffic Vol, veh/h | 2 | 0 | 1 | 23 | 2 | 1 | 0 | 858 | 0 | 0 | 2268 | 2 |
| Future Vol, veh/h | 2 | 0 | 1 | 23 | 2 | 1 | 0 | 858 | 0 | 0 | 2268 | 2 |
| Conflicting Peds, #/hr | 0 | 0 | 0 | 0 | 0 | 0 | 0 | 0 | 0 | 0 | 0 | 0 |
| Sign Control | Stop | Stop | Stop | Stop | Stop | Stop | Free | Free | Free | Free | Free | Free |
| RT Channelized | - | - | None | - | - | None | - | - | None | - | - | None |
| Storage Length | - | - | - | - | - | - | 315 | - | 280 | 517 | - | - |
| Veh in Median Storage, # | - | 0 | - | - | 0 | - | - | 0 | - | - | 0 | - |
| Grade, % | - | 0 | - | - | 0 | - | - | 0 | - | - | 0 | - |
| Peak Hour Factor | 85 | 85 | 85 | 85 | 85 | 85 | 85 | 85 | 85 | 85 | 85 | 85 |
| Heavy Vehicles, % | 50 | 50 | 50 | 0 | 0 | 0 | 11 | 11 | 11 | 4 | 4 | 4 |
| Mvmt Flow | 2 | 0 | 1 | 27 | 2 | 1 | 0 | 1009 | 0 | 0 | 2668 | 2 |

| Major/Minor | Minor2 | | Minor1 | | Major1 | | | Major2 | | | | |
|----------------------|--------|------|--------|------|--------|-----|------|--------|---|------|---|---|
| Conflicting Flow All | 3174 | 3677 | 1334 | 2343 | 3679 | 505 | 2670 | 0 | 0 | 1009 | 0 | 0 |
| Stage 1 | 2668 | 2668 | - | 1009 | 1009 | - | - | - | - | - | - | - |
| Stage 2 | 506 | 1009 | - | 1334 | 2670 | - | - | - | - | - | - | - |
| Critical Hdwy | 8.5 | 7.5 | 7.9 | 7.5 | 6.5 | 6.9 | 4.32 | - | - | 4.18 | - | - |
| Critical Hdwy Stg 1 | 7.5 | 6.5 | - | 6.5 | 5.5 | - | - | - | - | - | - | - |
| Critical Hdwy Stg 2 | 7.5 | 6.5 | - | 6.5 | 5.5 | - | - | - | - | - | - | - |
| Follow-up Hdwy | 4 | 4.5 | 3.8 | 3.5 | 4 | 3.3 | 2.31 | - | - | 2.24 | - | - |
| Pot Cap-1 Maneuver | ~2 | 2 | 95 | ~20 | 5 | 518 | 132 | - | - | 671 | - | - |
| Stage 1 | 11 | 22 | - | 261 | 320 | - | - | - | - | - | - | - |
| Stage 2 | 410 | 228 | - | 165 | 48 | - | - | - | - | - | - | - |
| Platoon blocked, % | | | | | | | | - | - | - | - | - |
| Mov Cap-1 Maneuver | ~1 | 2 | 95 | ~20 | 5 | 518 | 132 | - | - | 671 | - | - |
| Mov Cap-2 Maneuver | ~1 | 2 | - | ~20 | 5 | - | - | - | - | - | - | - |
| Stage 1 | 11 | 22 | - | 261 | 320 | - | - | - | - | - | - | - |
| Stage 2 | 406 | 228 | - | 163 | 48 | - | - | - | - | - | - | - |

| Approach | EB | | WB | | NB | | | SB | | |
|-----------------------|--------|--|-------|--|----|--|--|----|--|--|
| HCM Control Delay, \$ | 6632.1 | | 848.1 | | 0 | | | 0 | | |
| HCM LOS | F | | F | | | | | | | |

| Minor Lane/Major Mvmt | NBL | NBT | NBR | EBLn1 | WBLn1 | SBL | SBT | SBR |
|-----------------------|-----|-----|-----|-----------|----------|-----|-----|-----|
| Capacity (veh/h) | 132 | - | - | 1 | 17 | 671 | - | - |
| HCM Lane V/C Ratio | - | - | - | 3.529 | 1.799 | - | - | - |
| HCM Control Delay (s) | 0 | - | - | \$ 6632.1 | \$ 848.1 | 0 | - | - |
| HCM Lane LOS | A | - | - | F | F | A | - | - |
| HCM 95th %tile Q(veh) | 0 | - | - | 1.3 | 4.3 | 0 | - | - |

Notes
 ~: Volume exceeds capacity \$: Delay exceeds 300s +: Computation Not Defined *: All major volume in platoon

| Intersection | | | | | | |
|--------------------------|------|------|------|------|------|------|
| Int Delay, s/veh | 7.6 | | | | | |
| Movement | EBL | EBR | NBL | NBT | SBT | SBR |
| Lane Configurations | T | | | T | | |
| Traffic Vol, veh/h | 6 | 12 | 4 | 0 | 0 | 2 |
| Future Vol, veh/h | 6 | 12 | 4 | 0 | 0 | 2 |
| Conflicting Peds, #/hr | 0 | 0 | 0 | 0 | 0 | 0 |
| Sign Control | Stop | Stop | Free | Free | Free | Free |
| RT Channelized | - | None | - | None | - | None |
| Storage Length | 0 | - | - | - | - | - |
| Veh in Median Storage, # | 0 | - | - | 0 | 0 | - |
| Grade, % | 0 | - | - | 0 | 0 | - |
| Peak Hour Factor | 92 | 92 | 92 | 92 | 92 | 92 |
| Heavy Vehicles, % | 2 | 2 | 2 | 2 | 2 | 2 |
| Mvmt Flow | 7 | 13 | 4 | 0 | 0 | 2 |

| Major/Minor | Minor2 | Major1 | Major2 | | | |
|----------------------|--------|--------|--------|---|---|---|
| Conflicting Flow All | 9 | 1 | 2 | 0 | - | 0 |
| Stage 1 | 1 | - | - | - | - | - |
| Stage 2 | 8 | - | - | - | - | - |
| Critical Hdwy | 6.42 | 6.22 | 4.12 | - | - | - |
| Critical Hdwy Stg 1 | 5.42 | - | - | - | - | - |
| Critical Hdwy Stg 2 | 5.42 | - | - | - | - | - |
| Follow-up Hdwy | 3.518 | 3.318 | 2.218 | - | - | - |
| Pot Cap-1 Maneuver | 1011 | 1084 | 1620 | - | - | - |
| Stage 1 | 1022 | - | - | - | - | - |
| Stage 2 | 1015 | - | - | - | - | - |
| Platoon blocked, % | | | | - | - | - |
| Mov Cap-1 Maneuver | 1009 | 1084 | 1620 | - | - | - |
| Mov Cap-2 Maneuver | 1009 | - | - | - | - | - |
| Stage 1 | 1020 | - | - | - | - | - |
| Stage 2 | 1015 | - | - | - | - | - |

| Approach | EB | NB | SB |
|----------------------|-----|-----|----|
| HCM Control Delay, s | 8.5 | 7.2 | 0 |
| HCM LOS | A | | |

| Minor Lane/Major Mvmt | NBL | NBT | EBLn1 | SBT | SBR |
|-----------------------|-------|-----|-------|-----|-----|
| Capacity (veh/h) | 1620 | - | 1058 | - | - |
| HCM Lane V/C Ratio | 0.003 | - | 0.018 | - | - |
| HCM Control Delay (s) | 7.2 | 0 | 8.5 | - | - |
| HCM Lane LOS | A | A | A | - | - |
| HCM 95th %tile Q(veh) | 0 | - | 0.1 | - | - |

| Intersection | | | | | | |
|--------------------------|------|------|------|------|------|------|
| Int Delay, s/veh | 0.3 | | | | | |
| Movement | EBL | EBT | WBT | WBR | SBL | SBR |
| Lane Configurations | | ↑ | ↑ | | ↓ | |
| Traffic Vol, veh/h | 0 | 8 | 22 | 1 | 1 | 0 |
| Future Vol, veh/h | 0 | 8 | 22 | 1 | 1 | 0 |
| Conflicting Peds, #/hr | 0 | 0 | 0 | 0 | 0 | 0 |
| Sign Control | Free | Free | Free | Free | Stop | Stop |
| RT Channelized | - | None | - | None | - | None |
| Storage Length | - | - | - | - | 0 | - |
| Veh in Median Storage, # | - | 0 | 0 | - | 0 | - |
| Grade, % | - | 0 | 0 | - | 0 | - |
| Peak Hour Factor | 92 | 92 | 92 | 92 | 92 | 92 |
| Heavy Vehicles, % | 2 | 2 | 2 | 2 | 2 | 2 |
| Mvmt Flow | 0 | 9 | 24 | 1 | 1 | 0 |

| Major/Minor | Major1 | Major2 | Minor2 | | |
|----------------------|--------|--------|--------|---|-------------|
| Conflicting Flow All | - | 0 | - | 0 | 34 25 |
| Stage 1 | - | - | - | - | 25 - |
| Stage 2 | - | - | - | - | 9 - |
| Critical Hdwy | - | - | - | - | 6.42 6.22 |
| Critical Hdwy Stg 1 | - | - | - | - | 5.42 - |
| Critical Hdwy Stg 2 | - | - | - | - | 5.42 - |
| Follow-up Hdwy | - | - | - | - | 3.518 3.318 |
| Pot Cap-1 Maneuver | 0 | - | - | - | 979 1051 |
| Stage 1 | 0 | - | - | - | 998 - |
| Stage 2 | 0 | - | - | - | 1014 - |
| Platoon blocked, % | - | - | - | - | |
| Mov Cap-1 Maneuver | - | - | - | - | 979 1051 |
| Mov Cap-2 Maneuver | - | - | - | - | 979 - |
| Stage 1 | - | - | - | - | 998 - |
| Stage 2 | - | - | - | - | 1014 - |

| Approach | EB | WB | SB |
|----------------------|----|----|-----|
| HCM Control Delay, s | 0 | 0 | 8.7 |
| HCM LOS | | | A |

| Minor Lane/Major Mvmt | EBT | WBT | WBR | SBLn1 |
|-----------------------|-----|-----|-----|-------|
| Capacity (veh/h) | - | - | - | 979 |
| HCM Lane V/C Ratio | - | - | - | 0.001 |
| HCM Control Delay (s) | - | - | - | 8.7 |
| HCM Lane LOS | - | - | - | A |
| HCM 95th %tile Q(veh) | - | - | - | 0 |

| Intersection | | | | | | |
|--------------------------|------|------|------|------|------|------|
| Int Delay, s/veh | 2.7 | | | | | |
| Movement | EBT | EBR | WBL | WBT | NBL | NBR |
| Lane Configurations | | | | | | |
| Traffic Vol, veh/h | 17 | 15 | 2 | 6 | 11 | 5 |
| Future Vol, veh/h | 17 | 15 | 2 | 6 | 11 | 5 |
| Conflicting Peds, #/hr | 0 | 0 | 0 | 0 | 0 | 0 |
| Sign Control | Free | Free | Free | Free | Stop | Stop |
| RT Channelized | - | None | - | None | - | None |
| Storage Length | - | - | - | - | 0 | - |
| Veh in Median Storage, # | 0 | - | - | 0 | 0 | - |
| Grade, % | 0 | - | - | 0 | 0 | - |
| Peak Hour Factor | 87 | 87 | 87 | 87 | 87 | 87 |
| Heavy Vehicles, % | 0 | 0 | 0 | 0 | 0 | 0 |
| Mvmt Flow | 20 | 17 | 2 | 7 | 13 | 6 |

| Major/Minor | Major1 | Major2 | Minor1 | Minor2 |
|----------------------|--------|--------|--------|--------|
| Conflicting Flow All | 0 | 0 | 37 | 40 |
| Stage 1 | - | - | - | 29 |
| Stage 2 | - | - | - | 11 |
| Critical Hdwy | - | - | 4.1 | 6.4 |
| Critical Hdwy Stg 1 | - | - | - | 5.4 |
| Critical Hdwy Stg 2 | - | - | - | 5.4 |
| Follow-up Hdwy | - | - | 2.2 | 3.5 |
| Pot Cap-1 Maneuver | - | - | 1587 | 977 |
| Stage 1 | - | - | - | 999 |
| Stage 2 | - | - | - | 1017 |
| Platoon blocked, % | - | - | - | - |
| Mov Cap-1 Maneuver | - | - | 1587 | 976 |
| Mov Cap-2 Maneuver | - | - | - | 976 |
| Stage 1 | - | - | - | 999 |
| Stage 2 | - | - | - | 1016 |

| Approach | EB | WB | NB |
|----------------------|----|-----|-----|
| HCM Control Delay, s | 0 | 1.8 | 8.7 |
| HCM LOS | | | A |

| Minor Lane/Major Mvmt | NBLn1 | EBT | EBR | WBL | WBT |
|-----------------------|-------|-----|-----|-------|-----|
| Capacity (veh/h) | 999 | - | - | 1587 | - |
| HCM Lane V/C Ratio | 0.018 | - | - | 0.001 | - |
| HCM Control Delay (s) | 8.7 | - | - | 7.3 | 0 |
| HCM Lane LOS | A | - | - | A | A |
| HCM 95th %tile Q(veh) | 0.1 | - | - | 0 | - |

HCM 6th TWSC
3: Julian Baugh Rd & Cagle Mill Rd

2023 PM Peak Hour Build Conditions

| Intersection | | | | | | |
|--------------------------|------|------|------|------|------|------|
| Int Delay, s/veh | 2.3 | | | | | |
| Movement | EBL | EBR | NBL | NBT | SBT | SBR |
| Lane Configurations | | | | | | |
| Traffic Vol, veh/h | 7 | 0 | 9 | 11 | 23 | 7 |
| Future Vol, veh/h | 7 | 0 | 9 | 11 | 23 | 7 |
| Conflicting Peds, #/hr | 0 | 0 | 0 | 0 | 0 | 0 |
| Sign Control | Stop | Stop | Free | Free | Free | Free |
| RT Channelized | - | None | - | None | - | None |
| Storage Length | 0 | - | - | - | - | - |
| Veh in Median Storage, # | 0 | - | - | 0 | 0 | - |
| Grade, % | 0 | - | - | 0 | 0 | - |
| Peak Hour Factor | 75 | 75 | 75 | 75 | 75 | 75 |
| Heavy Vehicles, % | 0 | 0 | 0 | 0 | 0 | 0 |
| Mvmt Flow | 9 | 0 | 12 | 15 | 31 | 9 |

| Major/Minor | Minor2 | Major1 | | Major2 | |
|----------------------|--------|--------|------|--------|---|
| Conflicting Flow All | 75 | 36 | 40 | 0 | 0 |
| Stage 1 | 36 | - | - | - | - |
| Stage 2 | 39 | - | - | - | - |
| Critical Hdwy | 6.4 | 6.2 | 4.1 | - | - |
| Critical Hdwy Stg 1 | 5.4 | - | - | - | - |
| Critical Hdwy Stg 2 | 5.4 | - | - | - | - |
| Follow-up Hdwy | 3.5 | 3.3 | 2.2 | - | - |
| Pot Cap-1 Maneuver | 933 | 1042 | 1583 | - | - |
| Stage 1 | 992 | - | - | - | - |
| Stage 2 | 989 | - | - | - | - |
| Platoon blocked, % | | | | - | - |
| Mov Cap-1 Maneuver | 926 | 1042 | 1583 | - | - |
| Mov Cap-2 Maneuver | 926 | - | - | - | - |
| Stage 1 | 984 | - | - | - | - |
| Stage 2 | 989 | - | - | - | - |

| Approach | EB | NB | SB |
|----------------------|-----|-----|----|
| HCM Control Delay, s | 8.9 | 3.3 | 0 |
| HCM LOS | A | | |

| Minor Lane/Major Mvmt | NBL | NBT | EBLn1 | SBT | SBR |
|-----------------------|-------|-----|-------|-----|-----|
| Capacity (veh/h) | 1583 | - | 926 | - | - |
| HCM Lane V/C Ratio | 0.008 | - | 0.01 | - | - |
| HCM Control Delay (s) | 7.3 | 0 | 8.9 | - | - |
| HCM Lane LOS | A | A | A | - | - |
| HCM 95th %tile Q(veh) | 0 | - | 0 | - | - |

HCM 6th TWSC
4: Noah Martin Rd & Whitehall Rd

2023 PM Peak Hour Build Conditions

| Intersection | | | | | | | | | | | | |
|--------------------------|------|------|------|------|------|------|------|------|------|------|------|------|
| Int Delay, s/veh | 6.6 | | | | | | | | | | | |
| Movement | EBL | EBT | EBR | WBL | WBT | WBR | NBL | NBT | NBR | SBL | SBT | SBR |
| Lane Configurations | | ↕ | | | ↕ | | | ↕ | | | ↕ | |
| Traffic Vol, veh/h | 12 | 16 | 5 | 7 | 10 | 0 | 8 | 6 | 7 | 3 | 6 | 3 |
| Future Vol, veh/h | 12 | 16 | 5 | 7 | 10 | 0 | 8 | 6 | 7 | 3 | 6 | 3 |
| Conflicting Peds, #/hr | 0 | 0 | 0 | 0 | 0 | 0 | 0 | 0 | 0 | 0 | 0 | 0 |
| Sign Control | Stop | Stop | Stop | Stop | Stop | Stop | Free | Free | Free | Free | Free | Free |
| RT Channelized | - | - | None | - | - | None | - | - | None | - | - | None |
| Storage Length | - | - | - | - | - | - | - | - | - | - | - | - |
| Veh in Median Storage, # | - | 0 | - | - | 0 | - | - | 0 | - | - | 0 | - |
| Grade, % | - | 0 | - | - | 0 | - | - | 0 | - | - | 0 | - |
| Peak Hour Factor | 78 | 78 | 78 | 78 | 78 | 78 | 78 | 78 | 78 | 78 | 78 | 78 |
| Heavy Vehicles, % | 0 | 0 | 0 | 7 | 7 | 7 | 6 | 6 | 6 | 0 | 0 | 0 |
| Mvmt Flow | 15 | 21 | 6 | 9 | 13 | 0 | 10 | 8 | 9 | 4 | 8 | 4 |

| Major/Minor | Minor2 | | Minor1 | | | Major1 | | | Major2 | | | |
|----------------------|--------|-----|--------|-------|-------|--------|-------|---|--------|------|---|---|
| Conflicting Flow All | 57 | 55 | 10 | 65 | 53 | 13 | 12 | 0 | 0 | 17 | 0 | 0 |
| Stage 1 | 18 | 18 | - | 33 | 33 | - | - | - | - | - | - | - |
| Stage 2 | 39 | 37 | - | 32 | 20 | - | - | - | - | - | - | - |
| Critical Hdwy | 7.1 | 6.5 | 6.2 | 7.17 | 6.57 | 6.27 | 4.16 | - | - | 4.1 | - | - |
| Critical Hdwy Stg 1 | 6.1 | 5.5 | - | 6.17 | 5.57 | - | - | - | - | - | - | - |
| Critical Hdwy Stg 2 | 6.1 | 5.5 | - | 6.17 | 5.57 | - | - | - | - | - | - | - |
| Follow-up Hdwy | 3.5 | 4 | 3.3 | 3.563 | 4.063 | 3.363 | 2.254 | - | - | 2.2 | - | - |
| Pot Cap-1 Maneuver | 945 | 840 | 1077 | 917 | 829 | 1053 | 1581 | - | - | 1613 | - | - |
| Stage 1 | 1006 | 884 | - | 971 | 858 | - | - | - | - | - | - | - |
| Stage 2 | 981 | 868 | - | 972 | 869 | - | - | - | - | - | - | - |
| Platoon blocked, % | | | | | | | | - | - | - | - | - |
| Mov Cap-1 Maneuver | 928 | 833 | 1077 | 889 | 822 | 1053 | 1581 | - | - | 1613 | - | - |
| Mov Cap-2 Maneuver | 928 | 833 | - | 889 | 822 | - | - | - | - | - | - | - |
| Stage 1 | 1000 | 882 | - | 965 | 853 | - | - | - | - | - | - | - |
| Stage 2 | 960 | 863 | - | 942 | 867 | - | - | - | - | - | - | - |

| Approach | EB | | WB | | | NB | | | SB | | |
|----------------------|-----|--|-----|--|--|-----|--|--|-----|--|--|
| HCM Control Delay, s | 9.2 | | 9.4 | | | 2.8 | | | 1.8 | | |
| HCM LOS | A | | A | | | | | | | | |

| Minor Lane/Major Mvmt | NBL | NBT | NBR | EBLn1 | WBLn1 | SBL | SBT | SBR |
|-----------------------|-------|-----|-----|-------|-------|-------|-----|-----|
| Capacity (veh/h) | 1581 | - | - | 897 | 848 | 1613 | - | - |
| HCM Lane V/C Ratio | 0.006 | - | - | 0.047 | 0.026 | 0.002 | - | - |
| HCM Control Delay (s) | 7.3 | 0 | - | 9.2 | 9.4 | 7.2 | 0 | - |
| HCM Lane LOS | A | A | - | A | A | A | A | - |
| HCM 95th %tile Q(veh) | 0 | - | - | 0.1 | 0.1 | 0 | - | - |

| Intersection | | | | | | |
|--------------------------|------|------|------|------|------|------|
| Int Delay, s/veh | 0.6 | | | | | |
| Movement | EBL | EBT | WBT | WBR | SBL | SBR |
| Lane Configurations | | ↶ | ↷ | | ↶ | |
| Traffic Vol, veh/h | 16 | 326 | 134 | 10 | 9 | 4 |
| Future Vol, veh/h | 16 | 326 | 134 | 10 | 9 | 4 |
| Conflicting Peds, #/hr | 0 | 0 | 0 | 0 | 0 | 0 |
| Sign Control | Free | Free | Free | Free | Stop | Stop |
| RT Channelized | - | None | - | None | - | None |
| Storage Length | - | - | - | - | 0 | - |
| Veh in Median Storage, # | - | 0 | 0 | - | 0 | - |
| Grade, % | - | 0 | 0 | - | 0 | - |
| Peak Hour Factor | 87 | 87 | 87 | 87 | 87 | 87 |
| Heavy Vehicles, % | 2 | 2 | 5 | 5 | 0 | 0 |
| Mvmt Flow | 18 | 375 | 154 | 11 | 10 | 5 |

| Major/Minor | Major1 | Major2 | Minor2 | | |
|----------------------|--------|--------|--------|---|-----|
| Conflicting Flow All | 165 | 0 | - | 0 | 571 |
| Stage 1 | - | - | - | - | 160 |
| Stage 2 | - | - | - | - | 411 |
| Critical Hdwy | 4.12 | - | - | - | 6.4 |
| Critical Hdwy Stg 1 | - | - | - | - | 5.4 |
| Critical Hdwy Stg 2 | - | - | - | - | 5.4 |
| Follow-up Hdwy | 2.218 | - | - | - | 3.5 |
| Pot Cap-1 Maneuver | 1413 | - | - | - | 486 |
| Stage 1 | - | - | - | - | 874 |
| Stage 2 | - | - | - | - | 674 |
| Platoon blocked, % | | - | - | - | |
| Mov Cap-1 Maneuver | 1413 | - | - | - | 478 |
| Mov Cap-2 Maneuver | - | - | - | - | 478 |
| Stage 1 | - | - | - | - | 860 |
| Stage 2 | - | - | - | - | 674 |

| Approach | EB | WB | SB |
|----------------------|-----|----|------|
| HCM Control Delay, s | 0.4 | 0 | 11.6 |
| HCM LOS | | | B |

| Minor Lane/Major Mvmt | EBL | EBT | WBT | WBR | SBLn1 |
|-----------------------|-------|-----|-----|-----|-------|
| Capacity (veh/h) | 1413 | - | - | - | 557 |
| HCM Lane V/C Ratio | 0.013 | - | - | - | 0.027 |
| HCM Control Delay (s) | 7.6 | 0 | - | - | 11.6 |
| HCM Lane LOS | A | A | - | - | B |
| HCM 95th %tile Q(veh) | 0 | - | - | - | 0.1 |

| Intersection | | | | | | | | | | | | |
|--------------------------|------|------|------|------|------|------|------|------|------|------|------|------|
| Int Delay, s/veh | 16 | | | | | | | | | | | |
| Movement | EBL | EBT | EBR | WBL | WBT | WBR | NBL | NBT | NBR | SBL | SBT | SBR |
| Lane Configurations | | ↕ | | | ↕ | | ↕ | ↑↑ | ↕ | ↕ | ↑↑ | ↕ |
| Traffic Vol, veh/h | 6 | 1 | 4 | 13 | 0 | 4 | 2 | 2583 | 26 | 1 | 1139 | 4 |
| Future Vol, veh/h | 6 | 1 | 4 | 13 | 0 | 4 | 2 | 2583 | 26 | 1 | 1139 | 4 |
| Conflicting Peds, #/hr | 0 | 0 | 0 | 0 | 0 | 0 | 0 | 0 | 0 | 0 | 0 | 0 |
| Sign Control | Stop | Stop | Stop | Stop | Stop | Stop | Free | Free | Free | Free | Free | Free |
| RT Channelized | - | - | None | - | - | None | - | - | None | - | - | None |
| Storage Length | - | - | - | - | - | - | 315 | - | 280 | 517 | - | - |
| Veh in Median Storage, # | - | 0 | - | - | 0 | - | - | 0 | - | - | 0 | - |
| Grade, % | - | 0 | - | - | 0 | - | - | 0 | - | - | 0 | - |
| Peak Hour Factor | 96 | 96 | 96 | 96 | 96 | 96 | 96 | 96 | 96 | 96 | 96 | 96 |
| Heavy Vehicles, % | 0 | 0 | 0 | 0 | 0 | 0 | 4 | 4 | 4 | 8 | 8 | 8 |
| Mvmt Flow | 6 | 1 | 4 | 14 | 0 | 4 | 2 | 2691 | 27 | 1 | 1186 | 4 |

| Major/Minor | Minor2 | | Minor1 | | Major1 | | | Major2 | | | | |
|----------------------|--------|------|--------|------|--------|------|------|--------|---|------|---|---|
| Conflicting Flow All | 2538 | 3910 | 593 | 3291 | 3887 | 1346 | 1190 | 0 | 0 | 2718 | 0 | 0 |
| Stage 1 | 1188 | 1188 | - | 2695 | 2695 | - | - | - | - | - | - | - |
| Stage 2 | 1350 | 2722 | - | 596 | 1192 | - | - | - | - | - | - | - |
| Critical Hdwy | 7.5 | 6.5 | 6.9 | 7.5 | 6.5 | 6.9 | 4.18 | - | - | 4.26 | - | - |
| Critical Hdwy Stg 1 | 6.5 | 5.5 | - | 6.5 | 5.5 | - | - | - | - | - | - | - |
| Critical Hdwy Stg 2 | 6.5 | 5.5 | - | 6.5 | 5.5 | - | - | - | - | - | - | - |
| Follow-up Hdwy | 3.5 | 4 | 3.3 | 3.5 | 4 | 3.3 | 2.24 | - | - | 2.28 | - | - |
| Pot Cap-1 Maneuver | 14 | 3 | 454 | ~4 | 4 | 144 | 571 | - | - | 133 | - | - |
| Stage 1 | 203 | 264 | - | 22 | 46 | - | - | - | - | - | - | - |
| Stage 2 | 161 | 45 | - | 462 | 263 | - | - | - | - | - | - | - |
| Platoon blocked, % | | | | | | | | - | - | - | - | - |
| Mov Cap-1 Maneuver | 13 | 3 | 454 | ~3 | 4 | 144 | 571 | - | - | 133 | - | - |
| Mov Cap-2 Maneuver | 13 | 3 | - | ~3 | 4 | - | - | - | - | - | - | - |
| Stage 1 | 202 | 262 | - | 22 | 46 | - | - | - | - | - | - | - |
| Stage 2 | 156 | 45 | - | 453 | 261 | - | - | - | - | - | - | - |

| Approach | EB | | WB | | NB | | SB | |
|----------------------|----------|--|-----------|--|----|--|----|--|
| HCM Control Delay, s | \$ 531.7 | | \$ 3221.3 | | 0 | | 0 | |
| HCM LOS | F | | F | | | | | |

| Minor Lane/Major Mvmt | NBL | NBT | NBR | EBLn1 | WBLn1 | SBL | SBT | SBR |
|-----------------------|-------|-----|-----|----------|-----------|-------|-----|-----|
| Capacity (veh/h) | 571 | - | - | 14 | 4 | 133 | - | - |
| HCM Lane V/C Ratio | 0.004 | - | - | 0.818 | 4.427 | 0.008 | - | - |
| HCM Control Delay (s) | 11.3 | - | - | \$ 531.7 | \$ 3221.3 | 32.3 | - | - |
| HCM Lane LOS | B | - | - | F | F | D | - | - |
| HCM 95th %tile Q(veh) | 0 | - | - | 1.9 | 3.6 | 0 | - | - |

Notes
 ~: Volume exceeds capacity \$: Delay exceeds 300s +: Computation Not Defined *: All major volume in platoon

| Intersection | | | | | | |
|--------------------------|------|------|------|------|------|------|
| Int Delay, s/veh | 5.9 | | | | | |
| Movement | EBL | EBR | NBL | NBT | SBT | SBR |
| Lane Configurations | T | | | T | | T |
| Traffic Vol, veh/h | 5 | 7 | 12 | 0 | 0 | 8 |
| Future Vol, veh/h | 5 | 7 | 12 | 0 | 0 | 8 |
| Conflicting Peds, #/hr | 0 | 0 | 0 | 0 | 0 | 0 |
| Sign Control | Stop | Stop | Free | Free | Free | Free |
| RT Channelized | - | None | - | None | - | None |
| Storage Length | 0 | - | - | - | - | - |
| Veh in Median Storage, # | 0 | - | - | 0 | 0 | - |
| Grade, % | 0 | - | - | 0 | 0 | - |
| Peak Hour Factor | 92 | 92 | 92 | 92 | 92 | 92 |
| Heavy Vehicles, % | 2 | 2 | 2 | 2 | 2 | 2 |
| Mvmt Flow | 5 | 8 | 13 | 0 | 0 | 9 |

| Major/Minor | Minor2 | Major1 | Major2 | | | |
|----------------------|--------|--------|--------|---|---|---|
| Conflicting Flow All | 31 | 5 | 9 | 0 | - | 0 |
| Stage 1 | 5 | - | - | - | - | - |
| Stage 2 | 26 | - | - | - | - | - |
| Critical Hdwy | 6.42 | 6.22 | 4.12 | - | - | - |
| Critical Hdwy Stg 1 | 5.42 | - | - | - | - | - |
| Critical Hdwy Stg 2 | 5.42 | - | - | - | - | - |
| Follow-up Hdwy | 3.518 | 3.318 | 2.218 | - | - | - |
| Pot Cap-1 Maneuver | 983 | 1078 | 1611 | - | - | - |
| Stage 1 | 1018 | - | - | - | - | - |
| Stage 2 | 997 | - | - | - | - | - |
| Platoon blocked, % | | | | - | - | - |
| Mov Cap-1 Maneuver | 975 | 1078 | 1611 | - | - | - |
| Mov Cap-2 Maneuver | 975 | - | - | - | - | - |
| Stage 1 | 1010 | - | - | - | - | - |
| Stage 2 | 997 | - | - | - | - | - |

| Approach | EB | NB | SB |
|----------------------|-----|-----|----|
| HCM Control Delay, s | 8.5 | 7.3 | 0 |
| HCM LOS | A | | |

| Minor Lane/Major Mvmt | NBL | NBT | EBLn1 | SBT | SBR |
|-----------------------|-------|-----|-------|-----|-----|
| Capacity (veh/h) | 1611 | - | 1033 | - | - |
| HCM Lane V/C Ratio | 0.008 | - | 0.013 | - | - |
| HCM Control Delay (s) | 7.3 | 0 | 8.5 | - | - |
| HCM Lane LOS | A | A | A | - | - |
| HCM 95th %tile Q(veh) | 0 | - | 0 | - | - |

| Intersection | | | | | | |
|--------------------------|------|------|------|------|------|------|
| Int Delay, s/veh | 0.2 | | | | | |
| Movement | EBL | EBT | WBT | WBR | SBL | SBR |
| Lane Configurations | | ↑ | ↑ | | ↓ | |
| Traffic Vol, veh/h | 0 | 33 | 19 | 2 | 0 | 1 |
| Future Vol, veh/h | 0 | 33 | 19 | 2 | 0 | 1 |
| Conflicting Peds, #/hr | 0 | 0 | 0 | 0 | 0 | 0 |
| Sign Control | Free | Free | Free | Free | Stop | Stop |
| RT Channelized | - | None | - | None | - | None |
| Storage Length | - | - | - | - | 0 | - |
| Veh in Median Storage, # | - | 0 | 0 | - | 0 | - |
| Grade, % | - | 0 | 0 | - | 0 | - |
| Peak Hour Factor | 92 | 92 | 92 | 92 | 92 | 92 |
| Heavy Vehicles, % | 2 | 2 | 2 | 2 | 2 | 2 |
| Mvmt Flow | 0 | 36 | 21 | 2 | 0 | 1 |

| Major/Minor | Major1 | Major2 | Minor2 | | |
|----------------------|--------|--------|--------|---|-------------|
| Conflicting Flow All | - | 0 | - | 0 | 58 22 |
| Stage 1 | - | - | - | - | 22 - |
| Stage 2 | - | - | - | - | 36 - |
| Critical Hdwy | - | - | - | - | 6.42 6.22 |
| Critical Hdwy Stg 1 | - | - | - | - | 5.42 - |
| Critical Hdwy Stg 2 | - | - | - | - | 5.42 - |
| Follow-up Hdwy | - | - | - | - | 3.518 3.318 |
| Pot Cap-1 Maneuver | 0 | - | - | - | 949 1055 |
| Stage 1 | 0 | - | - | - | 1001 - |
| Stage 2 | 0 | - | - | - | 986 - |
| Platoon blocked, % | - | - | - | - | |
| Mov Cap-1 Maneuver | - | - | - | - | 949 1055 |
| Mov Cap-2 Maneuver | - | - | - | - | 949 - |
| Stage 1 | - | - | - | - | 1001 - |
| Stage 2 | - | - | - | - | 986 - |

| Approach | EB | WB | SB |
|----------------------|----|----|-----|
| HCM Control Delay, s | 0 | 0 | 8.4 |
| HCM LOS | | | A |

| Minor Lane/Major Mvmt | EBT | WBT | WBR | SBLn1 |
|-----------------------|-----|-----|-----|-------|
| Capacity (veh/h) | - | - | - | 1055 |
| HCM Lane V/C Ratio | - | - | - | 0.001 |
| HCM Control Delay (s) | - | - | - | 8.4 |
| HCM Lane LOS | - | - | - | A |
| HCM 95th %tile Q(veh) | - | - | - | 0 |

| Intersection | | | | | | |
|--------------------------|------|------|------|------|------|------|
| Int Delay, s/veh | 4.3 | | | | | |
| Movement | EBT | EBR | WBL | WBT | NBL | NBR |
| Lane Configurations | | | | | | |
| Traffic Vol, veh/h | 4 | 7 | 2 | 8 | 16 | 1 |
| Future Vol, veh/h | 4 | 7 | 2 | 8 | 16 | 1 |
| Conflicting Peds, #/hr | 0 | 0 | 0 | 0 | 0 | 0 |
| Sign Control | Free | Free | Free | Free | Stop | Stop |
| RT Channelized | - | None | - | None | - | None |
| Storage Length | - | - | - | - | 0 | - |
| Veh in Median Storage, # | 0 | - | - | 0 | 0 | - |
| Grade, % | 0 | - | - | 0 | 0 | - |
| Peak Hour Factor | 62 | 62 | 62 | 62 | 62 | 62 |
| Heavy Vehicles, % | 0 | 0 | 0 | 0 | 0 | 0 |
| Mvmt Flow | 6 | 11 | 3 | 13 | 26 | 2 |

| Major/Minor | Major1 | Major2 | Minor1 | Minor2 | Minor3 |
|----------------------|--------|--------|--------|--------|--------|
| Conflicting Flow All | 0 | 0 | 17 | 0 | 31 |
| Stage 1 | - | - | - | - | 12 |
| Stage 2 | - | - | - | - | 19 |
| Critical Hdwy | - | - | 4.1 | - | 6.4 |
| Critical Hdwy Stg 1 | - | - | - | - | 5.4 |
| Critical Hdwy Stg 2 | - | - | - | - | 5.4 |
| Follow-up Hdwy | - | - | 2.2 | - | 3.5 |
| Pot Cap-1 Maneuver | - | - | 1613 | - | 988 |
| Stage 1 | - | - | - | - | 1016 |
| Stage 2 | - | - | - | - | 1009 |
| Platoon blocked, % | - | - | - | - | - |
| Mov Cap-1 Maneuver | - | - | 1613 | - | 986 |
| Mov Cap-2 Maneuver | - | - | - | - | 986 |
| Stage 1 | - | - | - | - | 1016 |
| Stage 2 | - | - | - | - | 1007 |

| Approach | EB | WB | NB |
|----------------------|----|-----|-----|
| HCM Control Delay, s | 0 | 1.4 | 8.7 |
| HCM LOS | | | A |

| Minor Lane/Major Mvmt | NBLn1 | EBT | EBR | WBL | WBT |
|-----------------------|-------|-----|-----|-------|-----|
| Capacity (veh/h) | 991 | - | - | 1613 | - |
| HCM Lane V/C Ratio | 0.028 | - | - | 0.002 | - |
| HCM Control Delay (s) | 8.7 | - | - | 7.2 | 0 |
| HCM Lane LOS | A | - | - | A | A |
| HCM 95th %tile Q(veh) | 0.1 | - | - | 0 | - |

HCM 6th TWSC
 3: Julian Baugh Rd & Cagle Mill Rd

2028 AM Peak Hour Build Conditions

| Intersection | | | | | | |
|--------------------------|------|------|------|------|------|------|
| Int Delay, s/veh | 2.9 | | | | | |
| Movement | EBL | EBR | NBL | NBT | SBT | SBR |
| Lane Configurations | T | | T | | T | |
| Traffic Vol, veh/h | 11 | 0 | 2 | 13 | 6 | 6 |
| Future Vol, veh/h | 11 | 0 | 2 | 13 | 6 | 6 |
| Conflicting Peds, #/hr | 0 | 0 | 0 | 0 | 0 | 0 |
| Sign Control | Stop | Stop | Free | Free | Free | Free |
| RT Channelized | - | None | - | None | - | None |
| Storage Length | 0 | - | - | - | - | - |
| Veh in Median Storage, # | 0 | - | - | 0 | 0 | - |
| Grade, % | 0 | - | - | 0 | 0 | - |
| Peak Hour Factor | 72 | 72 | 72 | 72 | 72 | 72 |
| Heavy Vehicles, % | 0 | 0 | 0 | 0 | 0 | 0 |
| Mvmt Flow | 15 | 0 | 3 | 18 | 8 | 8 |

| Major/Minor | Minor2 | Major1 | | Major2 | |
|----------------------|--------|--------|------|--------|---|
| Conflicting Flow All | 36 | 12 | 16 | 0 | 0 |
| Stage 1 | 12 | - | - | - | - |
| Stage 2 | 24 | - | - | - | - |
| Critical Hdwy | 6.4 | 6.2 | 4.1 | - | - |
| Critical Hdwy Stg 1 | 5.4 | - | - | - | - |
| Critical Hdwy Stg 2 | 5.4 | - | - | - | - |
| Follow-up Hdwy | 3.5 | 3.3 | 2.2 | - | - |
| Pot Cap-1 Maneuver | 982 | 1074 | 1615 | - | - |
| Stage 1 | 1016 | - | - | - | - |
| Stage 2 | 1004 | - | - | - | - |
| Platoon blocked, % | | | | - | - |
| Mov Cap-1 Maneuver | 980 | 1074 | 1615 | - | - |
| Mov Cap-2 Maneuver | 980 | - | - | - | - |
| Stage 1 | 1014 | - | - | - | - |
| Stage 2 | 1004 | - | - | - | - |

| Approach | EB | NB | SB |
|----------------------|-----|----|----|
| HCM Control Delay, s | 8.7 | 1 | 0 |
| HCM LOS | A | | |

| Minor Lane/Major Mvmt | NBL | NBT | EBLn1 | SBT | SBR |
|-----------------------|-------|-----|-------|-----|-----|
| Capacity (veh/h) | 1615 | - | 980 | - | - |
| HCM Lane V/C Ratio | 0.002 | - | 0.016 | - | - |
| HCM Control Delay (s) | 7.2 | 0 | 8.7 | - | - |
| HCM Lane LOS | A | A | A | - | - |
| HCM 95th %tile Q(veh) | 0 | - | 0 | - | - |

HCM 6th TWSC
4: Noah Martin Rd & Whitehall Rd

2028 AM Peak Hour Build Conditions

| Intersection | | | | | | | | | | | | |
|--------------------------|------|------|------|------|------|------|------|------|------|------|------|------|
| Int Delay, s/veh | 5.7 | | | | | | | | | | | |
| Movement | EBL | EBT | EBR | WBL | WBT | WBR | NBL | NBT | NBR | SBL | SBT | SBR |
| Lane Configurations | | ↕ | | | ↕ | | | ↕ | | | ↕ | |
| Traffic Vol, veh/h | 2 | 6 | 2 | 0 | 21 | 4 | 1 | 2 | 1 | 2 | 16 | 4 |
| Future Vol, veh/h | 2 | 6 | 2 | 0 | 21 | 4 | 1 | 2 | 1 | 2 | 16 | 4 |
| Conflicting Peds, #/hr | 0 | 0 | 0 | 0 | 0 | 0 | 0 | 0 | 0 | 0 | 0 | 0 |
| Sign Control | Stop | Stop | Stop | Stop | Stop | Stop | Free | Free | Free | Free | Free | Free |
| RT Channelized | - | - | None | - | - | None | - | - | None | - | - | None |
| Storage Length | - | - | - | - | - | - | - | - | - | - | - | - |
| Veh in Median Storage, # | - | 0 | - | - | 0 | - | - | 0 | - | - | 0 | - |
| Grade, % | - | 0 | - | - | 0 | - | - | 0 | - | - | 0 | - |
| Peak Hour Factor | 79 | 79 | 79 | 79 | 79 | 79 | 79 | 79 | 79 | 79 | 79 | 79 |
| Heavy Vehicles, % | 14 | 14 | 14 | 6 | 6 | 6 | 33 | 33 | 33 | 10 | 10 | 10 |
| Mvmt Flow | 3 | 8 | 3 | 0 | 27 | 5 | 1 | 3 | 1 | 3 | 20 | 5 |

| Major/Minor | Minor2 | | Minor1 | | Major1 | | | Major2 | | | | |
|----------------------|--------|-------|--------|-------|--------|-------|-------|--------|---|------|---|---|
| Conflicting Flow All | 51 | 35 | 23 | 40 | 37 | 4 | 25 | 0 | 0 | 4 | 0 | 0 |
| Stage 1 | 29 | 29 | - | 6 | 6 | - | - | - | - | - | - | - |
| Stage 2 | 22 | 6 | - | 34 | 31 | - | - | - | - | - | - | - |
| Critical Hdwy | 7.24 | 6.64 | 6.34 | 7.16 | 6.56 | 6.26 | 4.43 | - | - | 4.2 | - | - |
| Critical Hdwy Stg 1 | 6.24 | 5.64 | - | 6.16 | 5.56 | - | - | - | - | - | - | - |
| Critical Hdwy Stg 2 | 6.24 | 5.64 | - | 6.16 | 5.56 | - | - | - | - | - | - | - |
| Follow-up Hdwy | 3.626 | 4.126 | 3.426 | 3.554 | 4.054 | 3.354 | 2.497 | - | - | 2.29 | - | - |
| Pot Cap-1 Maneuver | 919 | 834 | 1020 | 954 | 848 | 1068 | 1410 | - | - | 1567 | - | - |
| Stage 1 | 958 | 848 | - | 1006 | 883 | - | - | - | - | - | - | - |
| Stage 2 | 966 | 867 | - | 972 | 861 | - | - | - | - | - | - | - |
| Platoon blocked, % | | | | | | | | - | - | - | - | - |
| Mov Cap-1 Maneuver | 891 | 831 | 1020 | 943 | 845 | 1068 | 1410 | - | - | 1567 | - | - |
| Mov Cap-2 Maneuver | 891 | 831 | - | 943 | 845 | - | - | - | - | - | - | - |
| Stage 1 | 957 | 846 | - | 1005 | 882 | - | - | - | - | - | - | - |
| Stage 2 | 932 | 866 | - | 959 | 859 | - | - | - | - | - | - | - |

| Approach | EB | | WB | | NB | | SB | |
|----------------------|-----|--|-----|--|-----|--|-----|--|
| HCM Control Delay, s | 9.2 | | 9.3 | | 1.9 | | 0.7 | |
| HCM LOS | A | | A | | | | | |

| Minor Lane/Major Mvmt | NBL | NBT | NBR | EBLn1 | WBLn1 | SBL | SBT | SBR |
|-----------------------|-------|-----|-----|-------|-------|-------|-----|-----|
| Capacity (veh/h) | 1410 | - | - | 875 | 874 | 1567 | - | - |
| HCM Lane V/C Ratio | 0.001 | - | - | 0.014 | 0.036 | 0.002 | - | - |
| HCM Control Delay (s) | 7.6 | 0 | - | 9.2 | 9.3 | 7.3 | 0 | - |
| HCM Lane LOS | A | A | - | A | A | A | A | - |
| HCM 95th %tile Q(veh) | 0 | - | - | 0 | 0.1 | 0 | - | - |

| Intersection | | | | | | |
|--------------------------|------|------|------|------|------|------|
| Int Delay, s/veh | 0.4 | | | | | |
| Movement | EBL | EBT | WBT | WBR | SBL | SBR |
| Lane Configurations | | ↶ | ↷ | | ↶ | |
| Traffic Vol, veh/h | 0 | 100 | 452 | 3 | 2 | 15 |
| Future Vol, veh/h | 0 | 100 | 452 | 3 | 2 | 15 |
| Conflicting Peds, #/hr | 0 | 0 | 0 | 0 | 0 | 0 |
| Sign Control | Free | Free | Free | Free | Stop | Stop |
| RT Channelized | - | None | - | None | - | None |
| Storage Length | - | - | - | - | 0 | - |
| Veh in Median Storage, # | - | 0 | 0 | - | 0 | - |
| Grade, % | - | 0 | 0 | - | 0 | - |
| Peak Hour Factor | 89 | 89 | 89 | 89 | 89 | 89 |
| Heavy Vehicles, % | 9 | 9 | 3 | 3 | 13 | 13 |
| Mvmt Flow | 0 | 112 | 508 | 3 | 2 | 17 |

| Major/Minor | Major1 | Major2 | Minor2 | | |
|----------------------|--------|--------|--------|---|-------------|
| Conflicting Flow All | 511 | 0 | - | 0 | 622 510 |
| Stage 1 | - | - | - | - | 510 - |
| Stage 2 | - | - | - | - | 112 - |
| Critical Hdwy | 4.19 | - | - | - | 6.53 6.33 |
| Critical Hdwy Stg 1 | - | - | - | - | 5.53 - |
| Critical Hdwy Stg 2 | - | - | - | - | 5.53 - |
| Follow-up Hdwy | 2.281 | - | - | - | 3.617 3.417 |
| Pot Cap-1 Maneuver | 1019 | - | - | - | 433 542 |
| Stage 1 | - | - | - | - | 581 - |
| Stage 2 | - | - | - | - | 886 - |
| Platoon blocked, % | | - | - | - | |
| Mov Cap-1 Maneuver | 1019 | - | - | - | 433 542 |
| Mov Cap-2 Maneuver | - | - | - | - | 433 - |
| Stage 1 | - | - | - | - | 581 - |
| Stage 2 | - | - | - | - | 886 - |

| Approach | EB | WB | SB |
|----------------------|----|----|------|
| HCM Control Delay, s | 0 | 0 | 12.1 |
| HCM LOS | | | B |

| Minor Lane/Major Mvmt | EBL | EBT | WBT | WBR | SBLn1 |
|-----------------------|------|-----|-----|-----|-------|
| Capacity (veh/h) | 1019 | - | - | - | 526 |
| HCM Lane V/C Ratio | - | - | - | - | 0.036 |
| HCM Control Delay (s) | 0 | - | - | - | 12.1 |
| HCM Lane LOS | A | - | - | - | B |
| HCM 95th %tile Q(veh) | 0 | - | - | - | 0.1 |

| Intersection | | | | | | | | | | | | |
|--------------------------|------|------|------|------|------|------|------|------|------|------|------|------|
| Int Delay, s/veh | 19.8 | | | | | | | | | | | |
| Movement | EBL | EBT | EBR | WBL | WBT | WBR | NBL | NBT | NBR | SBL | SBT | SBR |
| Lane Configurations | | ↕ | | | ↕ | | ↕ | ↑↑ | ↕ | ↕ | ↑↑ | ↕ |
| Traffic Vol, veh/h | 2 | 0 | 1 | 27 | 2 | 1 | 0 | 997 | 0 | 0 | 2658 | 2 |
| Future Vol, veh/h | 2 | 0 | 1 | 27 | 2 | 1 | 0 | 997 | 0 | 0 | 2658 | 2 |
| Conflicting Peds, #/hr | 0 | 0 | 0 | 0 | 0 | 0 | 0 | 0 | 0 | 0 | 0 | 0 |
| Sign Control | Stop | Stop | Stop | Stop | Stop | Stop | Free | Free | Free | Free | Free | Free |
| RT Channelized | - | - | None | - | - | None | - | - | None | - | - | None |
| Storage Length | - | - | - | - | - | - | 315 | - | 280 | 517 | - | - |
| Veh in Median Storage, # | - | 0 | - | - | 0 | - | - | 0 | - | - | 0 | - |
| Grade, % | - | 0 | - | - | 0 | - | - | 0 | - | - | 0 | - |
| Peak Hour Factor | 85 | 85 | 85 | 85 | 85 | 85 | 85 | 85 | 85 | 85 | 85 | 85 |
| Heavy Vehicles, % | 50 | 50 | 50 | 0 | 0 | 0 | 11 | 11 | 11 | 4 | 4 | 4 |
| Mvmt Flow | 2 | 0 | 1 | 32 | 2 | 1 | 0 | 1173 | 0 | 0 | 3127 | 2 |

| Major/Minor | Minor2 | | Minor1 | | Major1 | | Major2 | | | | | |
|----------------------|--------|------|--------|------|--------|-----|--------|---|---|------|---|---|
| Conflicting Flow All | 3715 | 4300 | 1564 | 2737 | 4302 | 587 | 3129 | 0 | 0 | 1173 | 0 | 0 |
| Stage 1 | 3127 | 3127 | - | 1173 | 1173 | - | - | - | - | - | - | - |
| Stage 2 | 588 | 1173 | - | 1564 | 3129 | - | - | - | - | - | - | - |
| Critical Hdwy | 8.5 | 7.5 | 7.9 | 7.5 | 6.5 | 6.9 | 4.32 | - | - | 4.18 | - | - |
| Critical Hdwy Stg 1 | 7.5 | 6.5 | - | 6.5 | 5.5 | - | - | - | - | - | - | - |
| Critical Hdwy Stg 2 | 7.5 | 6.5 | - | 6.5 | 5.5 | - | - | - | - | - | - | - |
| Follow-up Hdwy | 4 | 4.5 | 3.8 | 3.5 | 4 | 3.3 | 2.31 | - | - | 2.24 | - | - |
| Pot Cap-1 Maneuver | ~ 1 | 1 | 63 | ~ 10 | ~ 2 | 458 | 85 | - | - | 580 | - | - |
| Stage 1 | 5 | 11 | - | 207 | 268 | - | - | - | - | - | - | - |
| Stage 2 | 360 | 183 | - | 119 | 27 | - | - | - | - | - | - | - |
| Platoon blocked, % | - | - | - | - | - | - | - | - | - | - | - | - |
| Mov Cap-1 Maneuver | - | 1 | 63 | ~ 10 | ~ 2 | 458 | 85 | - | - | 580 | - | - |
| Mov Cap-2 Maneuver | - | 1 | - | ~ 10 | ~ 2 | - | - | - | - | - | - | - |
| Stage 1 | 5 | 11 | - | 207 | 268 | - | - | - | - | - | - | - |
| Stage 2 | 356 | 183 | - | 117 | 27 | - | - | - | - | - | - | - |

| Approach | EB | WB | NB | SB |
|----------------------|----|-----------|----|----|
| HCM Control Delay, s | | \$ 2440.3 | 0 | 0 |
| HCM LOS | - | F | | |

| Minor Lane/Major Mvmt | NBL | NBT | NBR | EBLn1WBLn1 | SBL | SBT | SBR |
|-----------------------|-----|-----|-----|------------|-------|-----|-----|
| Capacity (veh/h) | 85 | - | - | - | 8 | 580 | - |
| HCM Lane V/C Ratio | - | - | - | - | 4.412 | - | - |
| HCM Control Delay (s) | 0 | - | - | \$ 2440.3 | 0 | - | - |
| HCM Lane LOS | A | - | - | F | A | - | - |
| HCM 95th %tile Q(veh) | 0 | - | - | 5.7 | 0 | - | - |

Notes
 ~: Volume exceeds capacity \$: Delay exceeds 300s +: Computation Not Defined *: All major volume in platoon

| Intersection | | | | | | |
|--------------------------|------|------|------|------|------|------|
| Int Delay, s/veh | 7.6 | | | | | |
| Movement | EBL | EBR | NBL | NBT | SBT | SBR |
| Lane Configurations | T | | | T | | |
| Traffic Vol, veh/h | 6 | 12 | 4 | 0 | 0 | 2 |
| Future Vol, veh/h | 6 | 12 | 4 | 0 | 0 | 2 |
| Conflicting Peds, #/hr | 0 | 0 | 0 | 0 | 0 | 0 |
| Sign Control | Stop | Stop | Free | Free | Free | Free |
| RT Channelized | - | None | - | None | - | None |
| Storage Length | 0 | - | - | - | - | - |
| Veh in Median Storage, # | 0 | - | - | 0 | 0 | - |
| Grade, % | 0 | - | - | 0 | 0 | - |
| Peak Hour Factor | 92 | 92 | 92 | 92 | 92 | 92 |
| Heavy Vehicles, % | 2 | 2 | 2 | 2 | 2 | 2 |
| Mvmt Flow | 7 | 13 | 4 | 0 | 0 | 2 |

| Major/Minor | Minor2 | Major1 | Major2 | | | |
|----------------------|--------|--------|--------|---|---|---|
| Conflicting Flow All | 9 | 1 | 2 | 0 | - | 0 |
| Stage 1 | 1 | - | - | - | - | - |
| Stage 2 | 8 | - | - | - | - | - |
| Critical Hdwy | 6.42 | 6.22 | 4.12 | - | - | - |
| Critical Hdwy Stg 1 | 5.42 | - | - | - | - | - |
| Critical Hdwy Stg 2 | 5.42 | - | - | - | - | - |
| Follow-up Hdwy | 3.518 | 3.318 | 2.218 | - | - | - |
| Pot Cap-1 Maneuver | 1011 | 1084 | 1620 | - | - | - |
| Stage 1 | 1022 | - | - | - | - | - |
| Stage 2 | 1015 | - | - | - | - | - |
| Platoon blocked, % | | | | - | - | - |
| Mov Cap-1 Maneuver | 1009 | 1084 | 1620 | - | - | - |
| Mov Cap-2 Maneuver | 1009 | - | - | - | - | - |
| Stage 1 | 1020 | - | - | - | - | - |
| Stage 2 | 1015 | - | - | - | - | - |

| Approach | EB | NB | SB |
|----------------------|-----|-----|----|
| HCM Control Delay, s | 8.5 | 7.2 | 0 |
| HCM LOS | A | | |

| Minor Lane/Major Mvmt | NBL | NBT | EBLn1 | SBT | SBR |
|-----------------------|-------|-----|-------|-----|-----|
| Capacity (veh/h) | 1620 | - | 1058 | - | - |
| HCM Lane V/C Ratio | 0.003 | - | 0.018 | - | - |
| HCM Control Delay (s) | 7.2 | 0 | 8.5 | - | - |
| HCM Lane LOS | A | A | A | - | - |
| HCM 95th %tile Q(veh) | 0 | - | 0.1 | - | - |

| Intersection | | | | | | |
|--------------------------|------|------|------|------|------|------|
| Int Delay, s/veh | 0.2 | | | | | |
| Movement | EBL | EBT | WBT | WBR | SBL | SBR |
| Lane Configurations | | ↑ | ↑ | | ↓ | |
| Traffic Vol, veh/h | 0 | 9 | 25 | 1 | 1 | 0 |
| Future Vol, veh/h | 0 | 9 | 25 | 1 | 1 | 0 |
| Conflicting Peds, #/hr | 0 | 0 | 0 | 0 | 0 | 0 |
| Sign Control | Free | Free | Free | Free | Stop | Stop |
| RT Channelized | - | None | - | None | - | None |
| Storage Length | - | - | - | - | 0 | - |
| Veh in Median Storage, # | - | 0 | 0 | - | 0 | - |
| Grade, % | - | 0 | 0 | - | 0 | - |
| Peak Hour Factor | 92 | 92 | 92 | 92 | 92 | 92 |
| Heavy Vehicles, % | 2 | 2 | 2 | 2 | 2 | 2 |
| Mvmt Flow | 0 | 10 | 27 | 1 | 1 | 0 |

| Major/Minor | Major1 | Major2 | Minor2 | | |
|----------------------|--------|--------|--------|---|-------------|
| Conflicting Flow All | - | 0 | - | 0 | 38 28 |
| Stage 1 | - | - | - | - | 28 - |
| Stage 2 | - | - | - | - | 10 - |
| Critical Hdwy | - | - | - | - | 6.42 6.22 |
| Critical Hdwy Stg 1 | - | - | - | - | 5.42 - |
| Critical Hdwy Stg 2 | - | - | - | - | 5.42 - |
| Follow-up Hdwy | - | - | - | - | 3.518 3.318 |
| Pot Cap-1 Maneuver | 0 | - | - | - | 974 1047 |
| Stage 1 | 0 | - | - | - | 995 - |
| Stage 2 | 0 | - | - | - | 1013 - |
| Platoon blocked, % | - | - | - | - | |
| Mov Cap-1 Maneuver | - | - | - | - | 974 1047 |
| Mov Cap-2 Maneuver | - | - | - | - | 974 - |
| Stage 1 | - | - | - | - | 995 - |
| Stage 2 | - | - | - | - | 1013 - |

| Approach | EB | WB | SB |
|----------------------|----|----|-----|
| HCM Control Delay, s | 0 | 0 | 8.7 |
| HCM LOS | | | A |

| Minor Lane/Major Mvmt | EBT | WBT | WBR | SBLn1 |
|-----------------------|-----|-----|-----|-------|
| Capacity (veh/h) | - | - | - | 974 |
| HCM Lane V/C Ratio | - | - | - | 0.001 |
| HCM Control Delay (s) | - | - | - | 8.7 |
| HCM Lane LOS | - | - | - | A |
| HCM 95th %tile Q(veh) | - | - | - | 0 |

| Intersection | | | | | | |
|--------------------------|------|------|------|------|------|------|
| Int Delay, s/veh | 2.7 | | | | | |
| Movement | EBT | EBR | WBL | WBT | NBL | NBR |
| Lane Configurations | | | | | | |
| Traffic Vol, veh/h | 20 | 18 | 2 | 7 | 13 | 6 |
| Future Vol, veh/h | 20 | 18 | 2 | 7 | 13 | 6 |
| Conflicting Peds, #/hr | 0 | 0 | 0 | 0 | 0 | 0 |
| Sign Control | Free | Free | Free | Free | Stop | Stop |
| RT Channelized | - | None | - | None | - | None |
| Storage Length | - | - | - | - | 0 | - |
| Veh in Median Storage, # | 0 | - | - | 0 | 0 | - |
| Grade, % | 0 | - | - | 0 | 0 | - |
| Peak Hour Factor | 87 | 87 | 87 | 87 | 87 | 87 |
| Heavy Vehicles, % | 0 | 0 | 0 | 0 | 0 | 0 |
| Mvmt Flow | 23 | 21 | 2 | 8 | 15 | 7 |

| Major/Minor | Major1 | Major2 | Minor1 | Minor2 | Minor3 |
|----------------------|--------|--------|--------|--------|--------|
| Conflicting Flow All | 0 | 0 | 44 | 0 | 46 |
| Stage 1 | - | - | - | - | 34 |
| Stage 2 | - | - | - | - | 12 |
| Critical Hdwy | - | - | 4.1 | - | 6.4 |
| Critical Hdwy Stg 1 | - | - | - | - | 5.4 |
| Critical Hdwy Stg 2 | - | - | - | - | 5.4 |
| Follow-up Hdwy | - | - | 2.2 | - | 3.5 |
| Pot Cap-1 Maneuver | - | - | 1577 | - | 969 |
| Stage 1 | - | - | - | - | 994 |
| Stage 2 | - | - | - | - | 1016 |
| Platoon blocked, % | - | - | - | - | - |
| Mov Cap-1 Maneuver | - | - | 1577 | - | 968 |
| Mov Cap-2 Maneuver | - | - | - | - | 968 |
| Stage 1 | - | - | - | - | 994 |
| Stage 2 | - | - | - | - | 1015 |

| Approach | EB | WB | NB |
|----------------------|----|-----|-----|
| HCM Control Delay, s | 0 | 1.6 | 8.7 |
| HCM LOS | | | A |

| Minor Lane/Major Mvmt | NBLn1 | EBT | EBR | WBL | WBT |
|-----------------------|-------|-----|-----|-------|-----|
| Capacity (veh/h) | 991 | - | - | 1577 | - |
| HCM Lane V/C Ratio | 0.022 | - | - | 0.001 | - |
| HCM Control Delay (s) | 8.7 | - | - | 7.3 | 0 |
| HCM Lane LOS | A | - | - | A | A |
| HCM 95th %tile Q(veh) | 0.1 | - | - | 0 | - |

HCM 6th TWSC
 3: Julian Baugh Rd & Cagle Mill Rd

2028 PM Peak Hour Build Conditions

| Intersection | | | | | | |
|--------------------------|------|------|------|------|------|------|
| Int Delay, s/veh | 2 | | | | | |
| Movement | EBL | EBR | NBL | NBT | SBT | SBR |
| Lane Configurations | T | | T | | T | |
| Traffic Vol, veh/h | 7 | 0 | 9 | 13 | 27 | 7 |
| Future Vol, veh/h | 7 | 0 | 9 | 13 | 27 | 7 |
| Conflicting Peds, #/hr | 0 | 0 | 0 | 0 | 0 | 0 |
| Sign Control | Stop | Stop | Free | Free | Free | Free |
| RT Channelized | - | None | - | None | - | None |
| Storage Length | 0 | - | - | - | - | - |
| Veh in Median Storage, # | 0 | - | - | 0 | 0 | - |
| Grade, % | 0 | - | - | 0 | 0 | - |
| Peak Hour Factor | 75 | 75 | 75 | 75 | 75 | 75 |
| Heavy Vehicles, % | 0 | 0 | 0 | 0 | 0 | 0 |
| Mvmt Flow | 9 | 0 | 12 | 17 | 36 | 9 |

| Major/Minor | Minor2 | Major1 | | Major2 | |
|----------------------|--------|--------|------|--------|---|
| Conflicting Flow All | 82 | 41 | 45 | 0 | 0 |
| Stage 1 | 41 | - | - | - | - |
| Stage 2 | 41 | - | - | - | - |
| Critical Hdwy | 6.4 | 6.2 | 4.1 | - | - |
| Critical Hdwy Stg 1 | 5.4 | - | - | - | - |
| Critical Hdwy Stg 2 | 5.4 | - | - | - | - |
| Follow-up Hdwy | 3.5 | 3.3 | 2.2 | - | - |
| Pot Cap-1 Maneuver | 925 | 1036 | 1576 | - | - |
| Stage 1 | 987 | - | - | - | - |
| Stage 2 | 987 | - | - | - | - |
| Platoon blocked, % | | | | - | - |
| Mov Cap-1 Maneuver | 918 | 1036 | 1576 | - | - |
| Mov Cap-2 Maneuver | 918 | - | - | - | - |
| Stage 1 | 979 | - | - | - | - |
| Stage 2 | 987 | - | - | - | - |

| Approach | EB | NB | SB |
|----------------------|----|----|----|
| HCM Control Delay, s | 9 | 3 | 0 |
| HCM LOS | A | | |

| Minor Lane/Major Mvmt | NBL | NBT | EBLn1 | SBT | SBR |
|-----------------------|-------|-----|-------|-----|-----|
| Capacity (veh/h) | 1576 | - | 918 | - | - |
| HCM Lane V/C Ratio | 0.008 | - | 0.01 | - | - |
| HCM Control Delay (s) | 7.3 | 0 | 9 | - | - |
| HCM Lane LOS | A | A | A | - | - |
| HCM 95th %tile Q(veh) | 0 | - | 0 | - | - |

| Intersection | | | | | | | | | | | | |
|--------------------------|------|------|------|------|------|------|------|------|------|------|------|------|
| Int Delay, s/veh | 6.7 | | | | | | | | | | | |
| Movement | EBL | EBT | EBR | WBL | WBT | WBR | NBL | NBT | NBR | SBL | SBT | SBR |
| Lane Configurations | | ↕ | | | ↕ | | | ↕ | | | ↕ | |
| Traffic Vol, veh/h | 13 | 19 | 6 | 8 | 11 | 0 | 9 | 6 | 8 | 3 | 6 | 3 |
| Future Vol, veh/h | 13 | 19 | 6 | 8 | 11 | 0 | 9 | 6 | 8 | 3 | 6 | 3 |
| Conflicting Peds, #/hr | 0 | 0 | 0 | 0 | 0 | 0 | 0 | 0 | 0 | 0 | 0 | 0 |
| Sign Control | Stop | Stop | Stop | Stop | Stop | Stop | Free | Free | Free | Free | Free | Free |
| RT Channelized | - | - | None | - | - | None | - | - | None | - | - | None |
| Storage Length | - | - | - | - | - | - | - | - | - | - | - | - |
| Veh in Median Storage, # | - | 0 | - | - | 0 | - | - | 0 | - | - | 0 | - |
| Grade, % | - | 0 | - | - | 0 | - | - | 0 | - | - | 0 | - |
| Peak Hour Factor | 78 | 78 | 78 | 78 | 78 | 78 | 78 | 78 | 78 | 78 | 78 | 78 |
| Heavy Vehicles, % | 0 | 0 | 0 | 7 | 7 | 7 | 6 | 6 | 6 | 0 | 0 | 0 |
| Mvmt Flow | 17 | 24 | 8 | 10 | 14 | 0 | 12 | 8 | 10 | 4 | 8 | 4 |

| Major/Minor | Minor2 | | Minor1 | | | Major1 | | | Major2 | | | |
|----------------------|--------|-----|--------|-------|-------|--------|-------|---|--------|------|---|---|
| Conflicting Flow All | 62 | 60 | 10 | 71 | 57 | 13 | 12 | 0 | 0 | 18 | 0 | 0 |
| Stage 1 | 18 | 18 | - | 37 | 37 | - | - | - | - | - | - | - |
| Stage 2 | 44 | 42 | - | 34 | 20 | - | - | - | - | - | - | - |
| Critical Hdwy | 7.1 | 6.5 | 6.2 | 7.17 | 6.57 | 6.27 | 4.16 | - | - | 4.1 | - | - |
| Critical Hdwy Stg 1 | 6.1 | 5.5 | - | 6.17 | 5.57 | - | - | - | - | - | - | - |
| Critical Hdwy Stg 2 | 6.1 | 5.5 | - | 6.17 | 5.57 | - | - | - | - | - | - | - |
| Follow-up Hdwy | 3.5 | 4 | 3.3 | 3.563 | 4.063 | 3.363 | 2.254 | - | - | 2.2 | - | - |
| Pot Cap-1 Maneuver | 938 | 835 | 1077 | 908 | 824 | 1053 | 1581 | - | - | 1612 | - | - |
| Stage 1 | 1006 | 884 | - | 966 | 854 | - | - | - | - | - | - | - |
| Stage 2 | 975 | 864 | - | 969 | 869 | - | - | - | - | - | - | - |
| Platoon blocked, % | | | | | | | | - | - | - | - | - |
| Mov Cap-1 Maneuver | 918 | 827 | 1077 | 874 | 816 | 1053 | 1581 | - | - | 1612 | - | - |
| Mov Cap-2 Maneuver | 918 | 827 | - | 874 | 816 | - | - | - | - | - | - | - |
| Stage 1 | 998 | 882 | - | 958 | 847 | - | - | - | - | - | - | - |
| Stage 2 | 951 | 857 | - | 934 | 867 | - | - | - | - | - | - | - |

| Approach | EB | | WB | | | NB | | | SB | | |
|----------------------|-----|--|-----|--|--|-----|--|--|-----|--|--|
| HCM Control Delay, s | 9.3 | | 9.4 | | | 2.9 | | | 1.8 | | |
| HCM LOS | A | | A | | | | | | | | |

| Minor Lane/Major Mvmt | NBL | NBT | NBR | EBLn1 | WBLn1 | SBL | SBT | SBR |
|-----------------------|-------|-----|-----|-------|-------|-------|-----|-----|
| Capacity (veh/h) | 1581 | - | - | 890 | 839 | 1612 | - | - |
| HCM Lane V/C Ratio | 0.007 | - | - | 0.055 | 0.029 | 0.002 | - | - |
| HCM Control Delay (s) | 7.3 | 0 | - | 9.3 | 9.4 | 7.2 | 0 | - |
| HCM Lane LOS | A | A | - | A | A | A | A | - |
| HCM 95th %tile Q(veh) | 0 | - | - | 0.2 | 0.1 | 0 | - | - |

| Intersection | | | | | | |
|--------------------------|------|------|------|------|------|------|
| Int Delay, s/veh | 0.5 | | | | | |
| Movement | EBL | EBT | WBT | WBR | SBL | SBR |
| Lane Configurations | | ↶ | ↷ | | ↶ | |
| Traffic Vol, veh/h | 18 | 383 | 157 | 11 | 10 | 5 |
| Future Vol, veh/h | 18 | 383 | 157 | 11 | 10 | 5 |
| Conflicting Peds, #/hr | 0 | 0 | 0 | 0 | 0 | 0 |
| Sign Control | Free | Free | Free | Free | Stop | Stop |
| RT Channelized | - | None | - | None | - | None |
| Storage Length | - | - | - | - | 0 | - |
| Veh in Median Storage, # | - | 0 | 0 | - | 0 | - |
| Grade, % | - | 0 | 0 | - | 0 | - |
| Peak Hour Factor | 87 | 87 | 87 | 87 | 87 | 87 |
| Heavy Vehicles, % | 2 | 2 | 5 | 5 | 0 | 0 |
| Mvmt Flow | 21 | 440 | 180 | 13 | 11 | 6 |

| Major/Minor | Major1 | Major2 | Minor2 | | |
|----------------------|--------|--------|--------|---|---------|
| Conflicting Flow All | 193 | 0 | - | 0 | 669 187 |
| Stage 1 | - | - | - | - | 187 - |
| Stage 2 | - | - | - | - | 482 - |
| Critical Hdwy | 4.12 | - | - | - | 6.4 6.2 |
| Critical Hdwy Stg 1 | - | - | - | - | 5.4 - |
| Critical Hdwy Stg 2 | - | - | - | - | 5.4 - |
| Follow-up Hdwy | 2.218 | - | - | - | 3.5 3.3 |
| Pot Cap-1 Maneuver | 1380 | - | - | - | 426 860 |
| Stage 1 | - | - | - | - | 850 - |
| Stage 2 | - | - | - | - | 625 - |
| Platoon blocked, % | | - | - | - | |
| Mov Cap-1 Maneuver | 1380 | - | - | - | 417 860 |
| Mov Cap-2 Maneuver | - | - | - | - | 417 - |
| Stage 1 | - | - | - | - | 833 - |
| Stage 2 | - | - | - | - | 625 - |

| Approach | EB | WB | SB |
|----------------------|-----|----|------|
| HCM Control Delay, s | 0.3 | 0 | 12.4 |
| HCM LOS | | | B |

| Minor Lane/Major Mvmt | EBL | EBT | WBT | WBR | SBLn1 |
|-----------------------|-------|-----|-----|-----|-------|
| Capacity (veh/h) | 1380 | - | - | - | 503 |
| HCM Lane V/C Ratio | 0.015 | - | - | - | 0.034 |
| HCM Control Delay (s) | 7.6 | 0 | - | - | 12.4 |
| HCM Lane LOS | A | A | - | - | B |
| HCM 95th %tile Q(veh) | 0 | - | - | - | 0.1 |

| Intersection | | | | | | | | | | | | |
|--------------------------|------|------|------|------|------|------|------|------|------|------|------|------|
| Int Delay, s/veh | 5.1 | | | | | | | | | | | |
| Movement | EBL | EBT | EBR | WBL | WBT | WBR | NBL | NBT | NBR | SBL | SBT | SBR |
| Lane Configurations | | ↕ | | | ↕ | | ↕ | ↑↑ | ↕ | ↕ | ↑↑ | ↕ |
| Traffic Vol, veh/h | 7 | 1 | 5 | 15 | 0 | 5 | 2 | 3024 | 31 | 1 | 1325 | 5 |
| Future Vol, veh/h | 7 | 1 | 5 | 15 | 0 | 5 | 2 | 3024 | 31 | 1 | 1325 | 5 |
| Conflicting Peds, #/hr | 0 | 0 | 0 | 0 | 0 | 0 | 0 | 0 | 0 | 0 | 0 | 0 |
| Sign Control | Stop | Stop | Stop | Stop | Stop | Stop | Free | Free | Free | Free | Free | Free |
| RT Channelized | - | - | None | - | - | None | - | - | None | - | - | None |
| Storage Length | - | - | - | - | - | - | 315 | - | 280 | 517 | - | - |
| Veh in Median Storage, # | - | 0 | - | - | 0 | - | - | 0 | - | - | 0 | - |
| Grade, % | - | 0 | - | - | 0 | - | - | 0 | - | - | 0 | - |
| Peak Hour Factor | 96 | 96 | 96 | 96 | 96 | 96 | 96 | 96 | 96 | 96 | 96 | 96 |
| Heavy Vehicles, % | 0 | 0 | 0 | 0 | 0 | 0 | 4 | 4 | 4 | 8 | 8 | 8 |
| Mvmt Flow | 7 | 1 | 5 | 16 | 0 | 5 | 2 | 3150 | 32 | 1 | 1380 | 5 |

| Major/Minor | Minor2 | | Minor1 | | Major1 | | | Major2 | | | | |
|----------------------|--------|------|--------|------|--------|------|------|--------|---|------|---|---|
| Conflicting Flow All | 2961 | 4568 | 690 | 3847 | 4541 | 1575 | 1385 | 0 | 0 | 3182 | 0 | 0 |
| Stage 1 | 1382 | 1382 | - | 3154 | 3154 | - | - | - | - | - | - | - |
| Stage 2 | 1579 | 3186 | - | 693 | 1387 | - | - | - | - | - | - | - |
| Critical Hdwy | 7.5 | 6.5 | 6.9 | 7.5 | 6.5 | 6.9 | 4.18 | - | - | 4.26 | - | - |
| Critical Hdwy Stg 1 | 6.5 | 5.5 | - | 6.5 | 5.5 | - | - | - | - | - | - | - |
| Critical Hdwy Stg 2 | 6.5 | 5.5 | - | 6.5 | 5.5 | - | - | - | - | - | - | - |
| Follow-up Hdwy | 3.5 | 4 | 3.3 | 3.5 | 4 | 3.3 | 2.24 | - | - | 2.28 | - | - |
| Pot Cap-1 Maneuver | ~ 7 | ~ 1 | 392 | ~ 1 | 1 | 101 | 480 | - | - | 85 | - | - |
| Stage 1 | 154 | 213 | - | ~ 11 | 26 | - | - | - | - | - | - | - |
| Stage 2 | 116 | 25 | - | 405 | 212 | - | - | - | - | - | - | - |
| Platoon blocked, % | | | | | | | | - | - | - | - | - |
| Mov Cap-1 Maneuver | ~ 7 | ~ 1 | 392 | - | 1 | 101 | 480 | - | - | 85 | - | - |
| Mov Cap-2 Maneuver | ~ 7 | ~ 1 | - | - | 1 | - | - | - | - | - | - | - |
| Stage 1 | 153 | 210 | - | ~ 11 | 26 | - | - | - | - | - | - | - |
| Stage 2 | 110 | 25 | - | 393 | 209 | - | - | - | - | - | - | - |

| Approach | EB | WB | NB | SB |
|-----------------------|--------|----|----|----|
| HCM Control Delay, \$ | 1718.1 | | 0 | 0 |
| HCM LOS | F | - | | |

| Minor Lane/Major Mvmt | NBL | NBT | NBR | EBLn1 | WBLn1 | SBL | SBT | SBR |
|-----------------------|-------|-----|-----|-----------|-------|-------|-----|-----|
| Capacity (veh/h) | 480 | - | - | 6 | - | 85 | - | - |
| HCM Lane V/C Ratio | 0.004 | - | - | 2.257 | - | 0.012 | - | - |
| HCM Control Delay (s) | 12.5 | - | - | \$ 1718.1 | - | 47.9 | - | - |
| HCM Lane LOS | B | - | - | F | - | E | - | - |
| HCM 95th %tile Q(veh) | 0 | - | - | 2.8 | - | 0 | - | - |

Notes
 ~: Volume exceeds capacity \$: Delay exceeds 300s +: Computation Not Defined *: All major volume in platoon

| Intersection | | | | | | |
|--------------------------|------|------|------|------|------|------|
| Int Delay, s/veh | 5.9 | | | | | |
| Movement | EBL | EBR | NBL | NBT | SBT | SBR |
| Lane Configurations | T | | | T | | T |
| Traffic Vol, veh/h | 5 | 7 | 12 | 0 | 0 | 8 |
| Future Vol, veh/h | 5 | 7 | 12 | 0 | 0 | 8 |
| Conflicting Peds, #/hr | 0 | 0 | 0 | 0 | 0 | 0 |
| Sign Control | Stop | Stop | Free | Free | Free | Free |
| RT Channelized | - | None | - | None | - | None |
| Storage Length | 0 | - | - | - | - | - |
| Veh in Median Storage, # | 0 | - | - | 0 | 0 | - |
| Grade, % | 0 | - | - | 0 | 0 | - |
| Peak Hour Factor | 92 | 92 | 92 | 92 | 92 | 92 |
| Heavy Vehicles, % | 2 | 2 | 2 | 2 | 2 | 2 |
| Mvmt Flow | 5 | 8 | 13 | 0 | 0 | 9 |

| Major/Minor | Minor2 | Major1 | | Major2 | |
|----------------------|--------|--------|-------|--------|---|
| Conflicting Flow All | 31 | 5 | 9 | 0 | 0 |
| Stage 1 | 5 | - | - | - | - |
| Stage 2 | 26 | - | - | - | - |
| Critical Hdwy | 6.42 | 6.22 | 4.12 | - | - |
| Critical Hdwy Stg 1 | 5.42 | - | - | - | - |
| Critical Hdwy Stg 2 | 5.42 | - | - | - | - |
| Follow-up Hdwy | 3.518 | 3.318 | 2.218 | - | - |
| Pot Cap-1 Maneuver | 983 | 1078 | 1611 | - | - |
| Stage 1 | 1018 | - | - | - | - |
| Stage 2 | 997 | - | - | - | - |
| Platoon blocked, % | | | | - | - |
| Mov Cap-1 Maneuver | 975 | 1078 | 1611 | - | - |
| Mov Cap-2 Maneuver | 975 | - | - | - | - |
| Stage 1 | 1010 | - | - | - | - |
| Stage 2 | 997 | - | - | - | - |

| Approach | EB | NB | SB |
|----------------------|-----|-----|----|
| HCM Control Delay, s | 8.5 | 7.3 | 0 |
| HCM LOS | A | | |

| Minor Lane/Major Mvmt | NBL | NBT | EBLn1 | SBT | SBR |
|-----------------------|-------|-----|-------|-----|-----|
| Capacity (veh/h) | 1611 | - | 1033 | - | - |
| HCM Lane V/C Ratio | 0.008 | - | 0.013 | - | - |
| HCM Control Delay (s) | 7.3 | 0 | 8.5 | - | - |
| HCM Lane LOS | A | A | A | - | - |
| HCM 95th %tile Q(veh) | 0 | - | 0 | - | - |

| Intersection | | | | | | |
|--------------------------|------|------|------|------|------|------|
| Int Delay, s/veh | 0.1 | | | | | |
| Movement | EBL | EBT | WBT | WBR | SBL | SBR |
| Lane Configurations | | ↑ | ↑ | | ↓ | |
| Traffic Vol, veh/h | 0 | 38 | 21 | 2 | 0 | 1 |
| Future Vol, veh/h | 0 | 38 | 21 | 2 | 0 | 1 |
| Conflicting Peds, #/hr | 0 | 0 | 0 | 0 | 0 | 0 |
| Sign Control | Free | Free | Free | Free | Stop | Stop |
| RT Channelized | - | None | - | None | - | None |
| Storage Length | - | - | - | - | 0 | - |
| Veh in Median Storage, # | - | 0 | 0 | - | 0 | - |
| Grade, % | - | 0 | 0 | - | 0 | - |
| Peak Hour Factor | 92 | 92 | 92 | 92 | 92 | 92 |
| Heavy Vehicles, % | 2 | 2 | 2 | 2 | 2 | 2 |
| Mvmt Flow | 0 | 41 | 23 | 2 | 0 | 1 |

| Major/Minor | Major1 | Major2 | Minor2 | | |
|----------------------|--------|--------|--------|---|-------------|
| Conflicting Flow All | - | 0 | - | 0 | 65 24 |
| Stage 1 | - | - | - | - | 24 - |
| Stage 2 | - | - | - | - | 41 - |
| Critical Hdwy | - | - | - | - | 6.42 6.22 |
| Critical Hdwy Stg 1 | - | - | - | - | 5.42 - |
| Critical Hdwy Stg 2 | - | - | - | - | 5.42 - |
| Follow-up Hdwy | - | - | - | - | 3.518 3.318 |
| Pot Cap-1 Maneuver | 0 | - | - | - | 941 1052 |
| Stage 1 | 0 | - | - | - | 999 - |
| Stage 2 | 0 | - | - | - | 981 - |
| Platoon blocked, % | - | - | - | - | |
| Mov Cap-1 Maneuver | - | - | - | - | 941 1052 |
| Mov Cap-2 Maneuver | - | - | - | - | 941 - |
| Stage 1 | - | - | - | - | 999 - |
| Stage 2 | - | - | - | - | 981 - |

| Approach | EB | WB | SB |
|----------------------|----|----|-----|
| HCM Control Delay, s | 0 | 0 | 8.4 |
| HCM LOS | | | A |

| Minor Lane/Major Mvmt | EBT | WBT | WBR | SBLn1 |
|-----------------------|-----|-----|-----|-------|
| Capacity (veh/h) | - | - | - | 1052 |
| HCM Lane V/C Ratio | - | - | - | 0.001 |
| HCM Control Delay (s) | - | - | - | 8.4 |
| HCM Lane LOS | - | - | - | A |
| HCM 95th %tile Q(veh) | - | - | - | 0 |

Appendix L: ICE Analysis

GDOT PI # (or N/A): Request By:
 County: GDOT District:
 Major (State) Road: Speed Limit:
 Minor (Crossing) ST: Speed Limit:
 Major ST Direction: Area Type:
 Intersection Control:
 Prepared By: Analyst:
 Date: Project ID:
 Project Purpose:

| | | 2022 Existing Year Volumes | | | | | |
|------|----------------------|----------------------------|-----|--------|-----|---|--|
| 2022 | Existing Data Year | 2202 (1045) [35400] | | | | | |
| 2023 | Project Opening Year | (0) | (8) | (1035) | (2) | Annual Growth Rate: <input type="text" value="3.3%"/> | |
| 2028 | Project Design Year | 0 | 33 | 2,168 | 1 | K Factor*: <input type="text" value="10%"/> | |

| | | | | | | | | |
|----------------|-----------------|---|---|---|---|--------|-----------------|-----|
| | | 2022 Intersection Daily Entering Volume (est): 35,950 | | | | | | |
| 24 (44) [1200] | EB Proposed Dwy | Peds ↓ | ↙ | ↓ | ↘ | Peds ← | 0 | (0) |
| | (19) | 6 | ↘ | ↙ | ↘ | ↙ | 0 | (0) |
| | (0) | 0 | ↘ | ↙ | ↘ | ↙ | 0 | (0) |
| | (25) | 18 | ↘ | ↙ | ↘ | ↙ | 0 | (0) |
| (0) | 0 | Peds ← | ↙ | ↑ | ↘ | Peds → | WB Proposed Dwy | |
| | | 921 (2481) [35400] | | | | | | |

| Peak Hour % Trucks | | | | |
|--------------------|----|-----|----|--|
| EB | WB | NB | SB | |
| 19% | 0% | 10% | 8% | |

Legend:
 000 = AM Peak Approach Vol
 (000) = PM Peak Approach Vol
 [000] = ADT Volume (Estimate)

Approach Splits: US 23/SR 365 - 0.98 / Proposed Dwy - 0.02

2023 Opening Year Volumes

2275 (1080) [37000]

| | | | | | | | | |
|----------------|-----------------|---|---|---|---|--------|-----------------|------|
| | | 2023 Intersection Daily Entering Volume (est): 38,500 | | | | | | |
| 25 (46) [1200] | EB Proposed Dwy | Peds ↓ | ↙ | ↓ | ↘ | Peds ← | 0 | (0) |
| | (20) | 6 | ↘ | ↙ | ↘ | ↙ | 55 | (40) |
| | (0) | 0 | ↘ | ↙ | ↘ | ↙ | 0 | (0) |
| | (26) | 19 | ↘ | ↙ | ↘ | ↙ | 105 | (65) |
| (0) | 0 | Peds ← | ↙ | ↑ | ↘ | Peds → | WB Proposed Dwy | |
| | | 950 (2560) [37200] | | | | | | |

2028 Design Year Volumes

2665 (1265) [43300]

| | | | | | | | | |
|----------------|-----------------|---|---|---|---|--------|-----------------|------|
| | | 2028 Intersection Daily Entering Volume (est): 44,950 | | | | | | |
| 29 (54) [1400] | EB Proposed Dwy | Peds ↓ | ↙ | ↓ | ↘ | Peds ← | 0 | (0) |
| | (23) | 7 | ↘ | ↙ | ↘ | ↙ | 55 | (40) |
| | (0) | 0 | ↘ | ↙ | ↘ | ↙ | 0 | (0) |
| | (31) | 22 | ↘ | ↙ | ↘ | ↙ | 105 | (65) |
| (0) | 0 | Peds ← | ↙ | ↑ | ↘ | Peds → | WB Proposed Dwy | |
| | | 1115 (3005) [43600] | | | | | | |

Introduction: In 2005, SAFETEA-LU established the Highway Safety Improvement Program (HSIP) and mandated that each state prepare a Strategic Highway Safety Plan (SHSP) to prioritize safety funding investments. Intersections quickly became a common component of most states' SHSP emphasis areas and HSIP project lists, including Georgia's SHSP. Intersection Control Evaluation (ICE) policies and procedures represent a traceable and transparent procedure to streamline the evaluation of intersection control alternatives, and further leverage safety advancements for intersection improvements beyond just the safety program. Approximately one-third of all traffic fatalities and roughly seventy five percent of all traffic crashes in Georgia occur at or adjacent to intersections. Accordingly, the Georgia SHSP includes an emphasis on enhancing intersection safety to advance the *Toward Zero Deaths* vision embraced by the Georgia Governor's Office of Highway Safety (GOHS). This ICE tool was developed to support the ICE policy, developed and adopted to help ensure that intersection investments across the entire Georgia highway system are selected, prioritized and implemented with defensible benefits for safety towards those ends.

Tool Goal: The goal of this ICE tool is to provide a simplified and consistent way of importing traffic, safety, cost, environmental impact and stakeholder posture data to assess and quantify intersection control improvement benefits. The tool supports the ICE policy and procedures to provide traceability, transparency, consistency and accountability when identifying and selecting an intersection control solution that both meets project purpose and reflects overall best value in terms of specific performance-based criteria.

Requirements: An ICE is required for any intersection improvement (e.g. new or modified intersection, widening/reconstruction or corridor project, or work accomplished through a driveway or encroachment permit that affects an intersection) where: **1)** the intersection includes at least one roadway designated as a State Route (State Highway System) or as part of the National Highway System; or **2)** the intersection will be designed or constructed using State or Federal funding. In certain circumstances where an ICE would otherwise be required, the requirement may be waived based on appropriate evidence presented with a written request. (See the "Waiver" tab to review criteria that may make a project waiver eligible and for instructions to submit a waiver request to the Department). An ICE is not required when the proposed work does not include any changes to the intersection design, involves only routine traffic signal timing and equipment maintenance, or for driveway permits where the driveway is not a new leg to an already existing intersection on either 1) a divided, multi-lane highway with a closed median and only right-in/right-out access or 2) an undivided roadway where the development is not required to construct left and/or right turn lanes (as per the Driveway Manual and District Traffic Engineer).

Two-Stage Process: A complete ICE process consists of two (2) distinct stages, and it is expected that the respective level of effort for completing both stages of ICE will correspond to the magnitude and complexity of the intersection. Prior to starting an ICE, the District Traffic Engineer and/or State Traffic Engineer should be consulted for advice on an appropriate level of effort. The Stage 1 and Stage 2 ICE forms are designed minimize required data inputs using drop-down menu choices and limiting text entry. All fields shaded grey include drop down menu choices and all fields shaded blue require data entry. All other cells in the worksheet are locked.

Stage 1: Screening Decision Record Stage 1 should be conducted early in the project development process and is intended to inform which alternatives are worthy of further evaluation in Stage 2. Stage 1 serves as a screening effort meant to *eliminate* non-competitive options and identify which alternatives merit further considerations based on their practical feasibility. Users should use good engineering judgement in responding to the seven policy questions by selecting "Yes" or "No" in the drop-down boxes. Alternatives should not be summarily eliminated without due consideration, and reasons for eliminating or advancing an alternative should be documented in the "Screening Decision Justification" column.

Stage 2: Alternative Selection Decision Record Stage 2 involves a more detailed and familiar evaluation of the alternatives identified in Stage 1 in order to support the selection of a preferred alternative that may be advanced to detailed design. Stage 2 data entry may require the use of external analysis tools to determine costs, operations and/or safety data that, combined with environmental and stakeholder posture data, form the basis of the ICE evaluation. A separate "CostEst" worksheet tab helps users develop pre-planning-level cost estimates for each Stage 2 alternative evaluated, and a separate Users Guide has been prepared to give guidance on Stage 1 and Stage 2 data entry. Once all data is entered, each alternative is scored and ranked, with the results reported at the bottom of the Stage 2 worksheet to inform on the best of the intersection controls evaluated for project recommendation.

Documentation: A complete ICE document consists of the combination of the outputs from either a completed and signed waiver form or both Stage 1 and Stage 2 worksheets (along with supporting costing and/or environmental documentation), to be included in the approved project Concept Report (or equivalent) or as a stand-alone document.

| | | | | | | | | | |
|--|----------------------------------|--|-----|-----|-----|-----|-----|--|---|
| GDOT PI # | 0008351 | <p>Note: Up to 5 alternatives may be selected and evaluated; Use this ICE Stage 1 to screen 5 or fewer alternatives to evaluate in Stage 2</p> <p style="font-size: small; text-align: center;"> 1. Does alternative address the project need in a balanced manner and in scale with the project? 2. Does alternative improve safety performance in terms of reducing severe crashes? 3. Does alternative incorporate safety performance in operations for pedestrians and/or bicyclists? 4. Does alternative improve (or preserve) traffic characteristics, delay, reliability, etc.? 5. Does alternative appear feasible given the site respect to other project factors? 6. Does alternative appear feasible with respect to other project factors? 7. Overall feasible alternative (select alternative for further evaluation in Stage 2)? </p> | | | | | | | |
| Project Location: | US 23/SR 365 @ Proposed Dwy | | | | | | | | |
| Existing Control: | Conventional (Minor Stop) | | | | | | | | |
| Prepared by: | Pond & Company | | | | | | | | |
| Date: | 2/29/2024 | <p>Answer "Yes" or "No" to each policy question for each control type to identify which alternatives should be evaluated in the Stage 2 Decision Record; enter justification in the rightmost column</p> <p>Screening Decision Justification:</p> | | | | | | | |
| <p>Intersection Alternative (see "Intersections" tab for detailed description of intersection/interchange type)</p> | | | | | | | | | |
| Unsignalized Intersections | Conventional (Minor Stop) | No | No | No | No | No | No | No | Existing control, which has a failing LOS |
| | Conventional (All-Way Stop) | No | No | Yes | No | No | No | No | Major street capacity needs don't justify |
| | Mini Roundabout | No | No | No | No | No | No | No | Not justified due to intersection capacity needs |
| | Single Lane Roundabout | No | No | No | No | No | No | No | Existing lane configuration and capacity needs don't justify |
| | Multilane Roundabout | No | Yes | No | Yes | No | No | No | Not appropriate for the scale of this intersection |
| | RCUT (stop control) | Yes | Yes | Yes | Yes | Yes | Yes | Yes | Identified as feasible alternative |
| | RIRO w/down stream U-Turn | No | Yes | Yes | No | Yes | No | No | Side street left turn & thru volumes too high. Alternative would be restrictive |
| | High-T (unsignalized) | Yes | Yes | No | Yes | Yes | Yes | No | Not applicable. Intersection is not a T intersection |
| | Offset-T Intersections | No | No | No | No | No | No | No | Not applicable. Intersection is not a T intersection |
| | Diamond Interch (Stop Control) | No | No | No | No | No | No | No | Intersection not an interchange |
| | Diamond Interch (RAB Control) | No | No | No | No | No | No | No | Intersection not an interchange |
| | No LT Lane Improvements | No | No | No | No | No | No | No | N/A |
| | No RT Lane Improvements | No | No | No | No | No | No | No | N/A |
| Other unsignalized (provide description): | No | No | No | No | No | No | No | N/A | |
| Signalized Intersections | Traffic Signal | Yes | Yes | Yes | Yes | Yes | No | No | Signal not warranted |
| | Median U-Turn (Indirect Left) | Yes | Yes | No | No | Yes | No | No | Signal not warranted |
| | RCUT (signalized) | Yes | Yes | Yes | Yes | Yes | No | No | Signal not warranted |
| | Displaced Left Turn (CFI) | No | Yes | No | No | No | No | No | Not appropriate for the scale of this intersection |
| | Continuous Green-T | No | No | No | No | No | No | No | Not applicable. Intersection is not a T intersection |
| | Jughandle | No | Yes | No | Yes | No | No | No | Not appropriate for the scale of this intersection |
| | Quadrant Roadway | No | Yes | No | Yes | No | No | No | Not appropriate for the scale of this intersection |
| | Diamond Interch (Signal Control) | No | No | No | No | No | No | No | Intersection not an interchange |
| | Diverging Diamond | No | No | No | No | No | No | No | Intersection not an interchange |
| | Single Point Interchange | No | No | No | No | No | No | No | Intersection not an interchange |
| | No LT Lane Improvements | No | No | No | No | No | No | No | Existing lane configurations include turn lanes. Double lanes not warrantd |
| No RT Lane Improvements | No | No | No | No | No | No | No | Existing lane configurations include turn lanes. Double lanes not warrantd | |
| Other Signalized (provide description): | No | No | No | No | No | No | No | N/A | |

☐ = Intersection type selected for more detailed analysis in Stage 2 Alternative Selection Decision Record



GDOT INTERSECTION CONTROL EVALUATION (ICE) WAIVER FORM

ICE Version 2.15 | Revised 07/01/2019

Waiver Request - Level 1

In certain circumstances where an ICE would otherwise be required, an ICE may be waived based on appropriate evidence presented with a written request. Scenarios in which an ICE waiver request may be considered include:

- Proposed improvements do not substantially alter the character of the intersection, and are considered minor in nature, such as extending existing turn lane(s) or modifying signal phasing at an existing traffic signal
- The intersection consists of a public roadway intersecting a divided, multilane roadway where the access will be limited to a closed median with only right-in/right-out access that will operate acceptably; or
- The intersection is along an undivided, two-lane roadway that will not be widened and meets the following criteria:
 - Low risk in terms of exposure (total intersection entering volume less than 1,000 vehicles /day)
 - Latest 5 years of crash history is not indicative of a crash problem (no discernible crash patterns coupled with low crash frequency and severity)
 - Layout has no unusual or undesirable geometric features (such as restricted sight distance)
 - The proposed changes are not expected to adversely affect safety

If only one alternative is determined to be feasible from the ICE Stage 1, then a waiver may be submitted in lieu of completing ICE Stage 2. The waiver must clearly explain why there is no other feasible alternative. A Waiver Form should also be submitted to document an agreed upon decision to select a preferred alternative other than the highest scoring alternative in Stage 2.

ICE waiver forms with supporting documentation should be submitted for approval to the Office of Traffic Operations or District Engineer (depending on Waiver level). Questions regarding the waiver process should be routed to the State Traffic Engineer.

Project Information: Location: US 23/SR 365 @ Proposed Dwy GDOT PI # (or N/A): 0008351
 County: Hall Requested By: Hall County
 GDOT District: 1 - Gainesville Prepared By: Pond & Company
 Area Type: Suburb/Transition Analyst: 0
 Existing Intersection Control: Conventional (Minor Stop) Date: 2/29/2024
 Waiver Request Type: New Median Opening

Traffic and Operations Data:¹

| | | |
|---|--------------------|-----------|
| Intersection meets signal/AWS warrants? | None | |
| Traffic Analysis Type: | Intersection Delay | |
| Existing Avg Daily Traffic (Major Street): | 29,144 | |
| Existing Avg Daily Traffic (Minor Street): | 264 | |
| Analysis Period: | AM Peak | PM Peak |
| 2023 Opening Yr Peak Hour Intersection Delay: | 44.3 sec | 120.0 sec |
| 2023 Opening Yr Peak Hour Intersection V/C: | 0.57 | 1.23 |
| 2028 Design Yr Peak Hour Intersection Delay: | 75.3 sec | 281.1 sec |
| 2028 Design Yr Peak Hour Intersection V/C: | 1.04 | 1.30 |

| Crash Data (Required): ¹ | | | |
|---|----------------|---------------|--------------|
| Crash Data: Enter most recent 5 years of crash data | Crash Severity | | |
| | PDO | Injury Crash* | Fatal Crash* |
| Angle | 2 | 0 | 0 |
| Head-On | 0 | 0 | 0 |
| Rear End | 2 | 0 | 0 |
| Sideswipe - same | 1 | 0 | 0 |
| Sideswipe - opposite | 0 | 0 | 0 |
| Not Collision w/Motor Veh | 1 | 0 | 0 |
| TOTALS: | 6 | 0 | 0 |

Crash Type



¹Crash data required for all existing intersections. ADT's required if available (from data collected or nearest GDOT count station site). Capacity data is optional unless needed to justify basis of the waiver request.

* Number of crashes resulting in injuries / fatalities, not number of persons

Description of Work / Justification for Waiver (Required): Install RCUT at the intersection of US 23/SR 365/Cornelia Hwy due to the traffic impacts of a proposed residential development. This intersection does not warrant a signal and its high major street volume does not justify a roundabout. Additionally, it is not a T intersection or interchange and the RIRO alternative would be restrictive since there is a high amount of minor street left turning vehicles.

Proposed Intersection Control: RCUT (stop control)

REQUESTED BY: Zach Puckett Date: 2/29/2024

Title: Project Engineer, IMSA Level II

APPROVED BY: _____ Date: _____

Name: _____

Chief Engineer or (Approved Delegate)