

THE OXFORD ANNUAL FOR BOYS

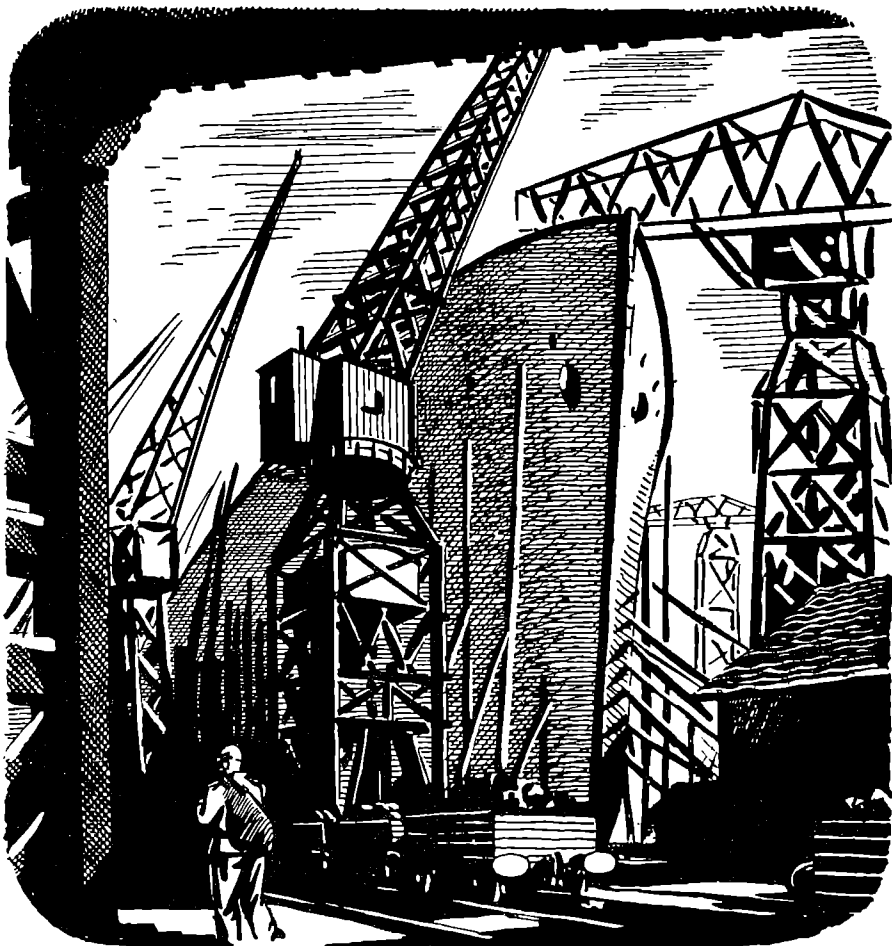

**THE
OXFORD ANNUAL
FOR BOYS**

**EDITED BY HERBERT STRANG
33RD YEAR**



**HUMPHREY MILFORD
OXFORD UNIVERSITY PRESS**

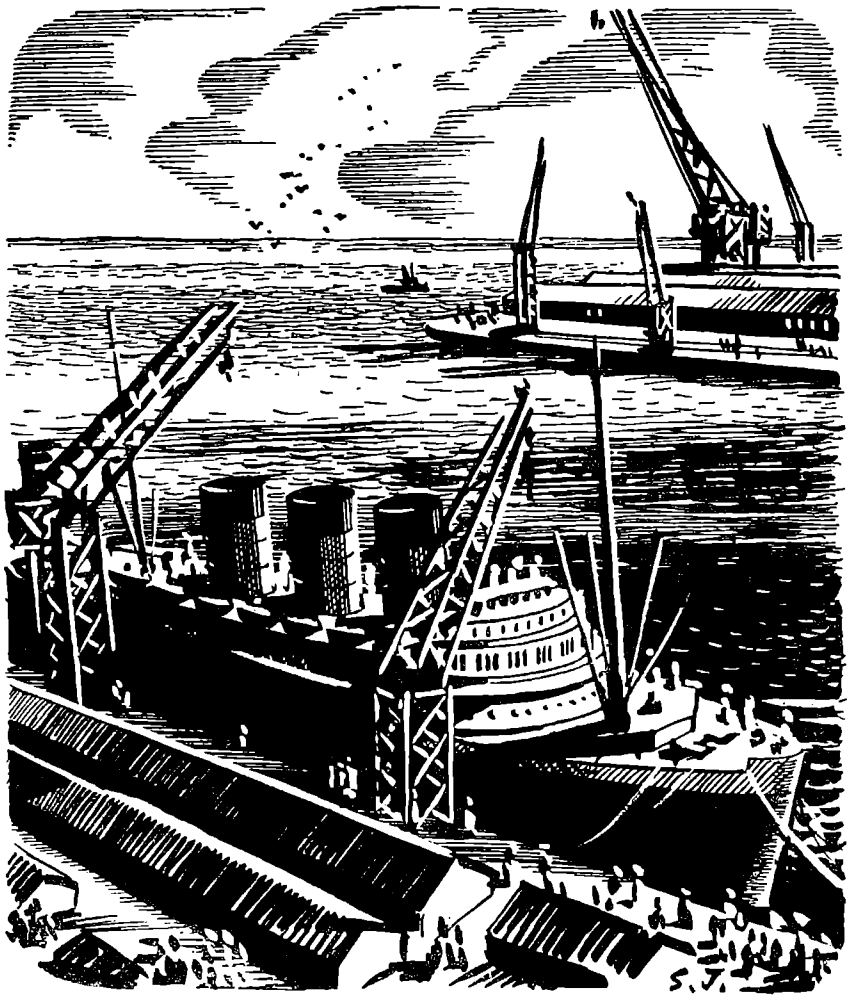

PRINTED IN GREAT BRITAIN AT THE
UNIVERSITY PRESS, OXFORD, BY JOHN JOHNSON

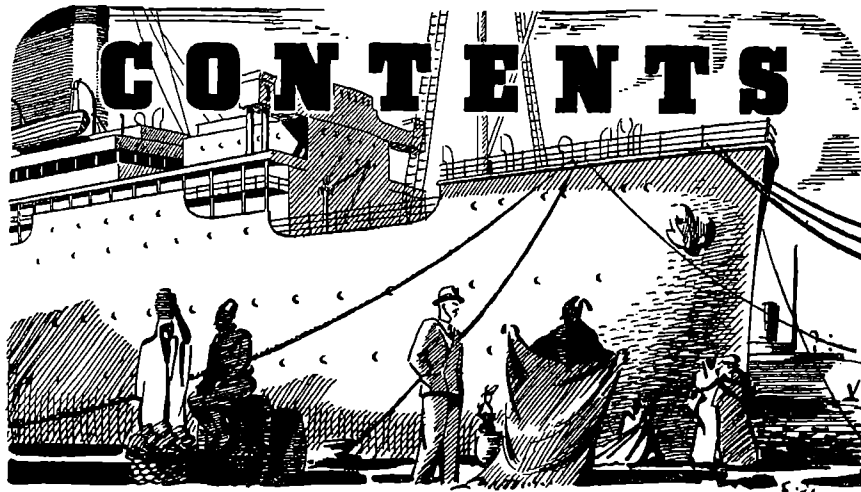

No Pirates Nowadays	5
By PATRICK RUSS	
Outlaw of the Sheep Country	23
By IAN MILLER	
Huntsman Joe	33
By R. B. v. W.	
The Army of To-day	35
By LIEUT.-COLONEL DONALD PORTWAY, R.E.	
Something New	42
By R. B. v. W.	
A SHOT IN THE AIR	43
By AIR COMMODORE L. E. O. CHARLTON, C.B., C.M.G., D.S.O.	
Dungudza—The Roan Bull	56
By WILFRID ROBERTSON	
Sea-Lion Island	65
By C. FOX SMITH	
An Elephant Rodeo in the Himalayas	77
By W. ROBERT FORAN	
Just a Toss-up	86
By R. B. v. W.	

'Hot Box'	87
By H. C. WEBSTER	
Mr. Flick Passes By	99
By MICHAEL POOLE	
Five Hundred Pounds of Shark for Company	114
By GEORGE S. SURREY	
Automobile Press Test	121
By J. HARRISON, A.M.I.MECH.E., A.M.I.A.E.	
The Credit For It	129
By GUNBY HADATH	
Kicking Goals at Rugger	145
By REFEREE	
A Cipher Affair	151
By ALEXANDER d'AGAPEYEFF	
The Lost Ball	167
By MAJOR J. T. GORMAN	
Harris v. Snagglesmith	179
By R. J. MCGREGOR	

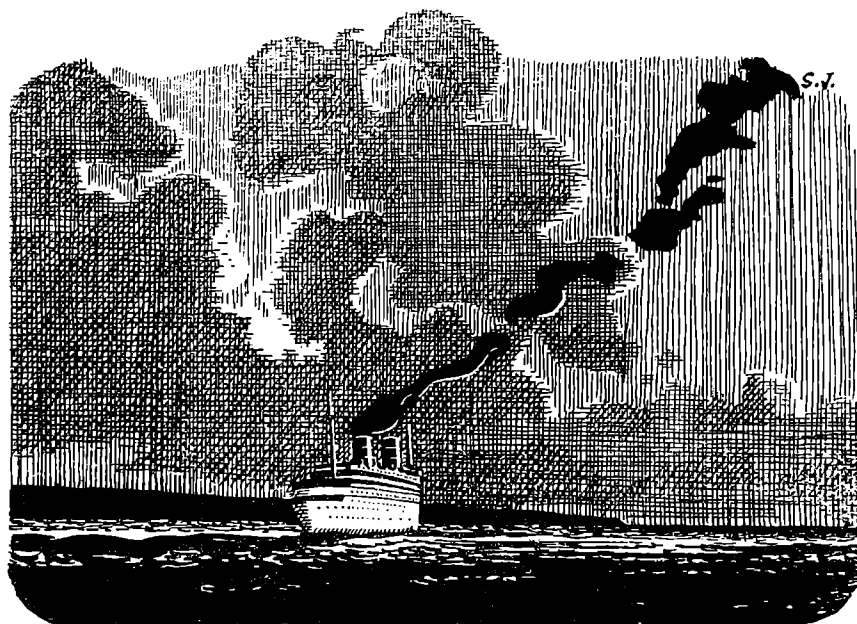

NO PIRATES NOWADAYS



**By
PATRICK RUSS**

I

'**S**PEAKING of furs,' said Sullivan, fanning himself with a folded palm-leaf, 'did I ever tell you of that Japanese cook I met while you were in Batavia?'

'We were not speaking of furs in the first place, and what has a Japanese cook got to do with them, anyhow?' asked Ross, leaning back against his camel saddle. The big Scot was too hot to fan himself.

Sullivan stretched his tall, lean body, and yawned. 'It was just an idea that passed across my mind,' he said.

'Not one of your ideas for making money?' asked Ross suspiciously.

'Well, as a matter of fact——'

'Ha! I was afraid of that. Now listen: you can take your idea and bury it. You'll have plenty of time to dig a nice deep hole before this Kaid of yours turns up with the money.'

'Arrah, don't let that be worrying your Scotch soul, my boyo——'

'Scots, please,' interrupted Ross; 'and you listen to me. Quite apart from the fact that we'll never see our guns or our money again, I'm sick of this beastly oasis, and I'm tired of dates for breakfast, lunch, and tea, with half a peck of sand for dinner. We're sailormen, and we ought to earn

our living on the sea, not sitting by a puddle in a desert a thousand miles from the nearest port. So just you get it into your teak head, Sullivan, that I dislike the sound of your voice when you talk about ideas.'

A little before moonrise the same night, five white mehari camels hunkered down at the oasis.

'Salaam, Kaid,' said Sullivan, greeting the Arab.

'Salaam aleikum, Effendi,' replied the Kaid, touching his head and heart. They exchanged a few remarks, and then, apparently as an after-thought, the Kaid mentioned that he had some money. His men brought leather bags and a rug. The Kaid rung the coins out on to the rug one by one, while Sullivan, knowing the breeding of the desert, affected not to count them.

.

Next day, as Sullivan and Ross travelled across the desert on the thoroughbred trotting camels that the Kaid had left as a present, the Irishman settled himself comfortably, and said, 'I don't want to rub it in, my good man, but if I were not a gentleman and the descendant of ancient Irish kings, I should say that there was something in my ideas.'

'Mphm,' replied Ross. For a long while they rode in silence. 'Ay,' said Ross, at last. 'More by luck than good management, though. We ought to stick to the sea.'

'Very true: now this idea of mine would be entirely on the sea.'

'Then you'd better tell me about it. You'll surely burst if you don't.'

'It was like this, then. Yamamoto, the cook I was telling you about, went down with pneumonia out beyond Medicine Hat, and I looked after him. He had been a sailor most of his time—he came from one of the northern Japanese islands—and a little before he died, he told me of an island way beyond Saghalien where the sea-otters breed: he was more than half Ainu, and his totem was the sea-otter, so he had never made use of the knowledge, but he passed it on to me, as a sort of payment for looking after him.'

'Sea-otters, eh? The fur is more valuable than ermine.'

'Yes. Next to chinchilla it's the rarest fur in the world. My idea is that we go and get some. We have got the capital now for a boat, and I have got a good many more details—that's just the bare outline.'

'What, go to Saghalien because of the babbling of a delirious Japanese

cook? Blethering foolishness. Those parts are very poorly charted: and how do you know he was really talking about sea-otters, anyway? It was probably a moribund seal that his cousin's wife's brother-in-law saw. Tush! Stuff! If you find me wandering about in those latitudes calling "Puss-puss-puss" to imaginary sea-otters, you can call me a yellow-belly.'

II

The schooner pushed slowly through the fog: the soft chug-chug of her auxiliary engine echoed back from the blank yellow wall that surrounded her. The look-out man, who had been staring for hours into the dense whirling vapour, started as he heard a step behind him. He could hardly distinguish the dim form in the murk.

'You're a yellow-belly, Ross,' came Sullivan's voice through the fog.

'Och, you've said that twice to-day, man. D'ye think we shall ever be able to take our bearings again? It's four days since we've had a shot at the sun. And I'm afraid there's ice about by the smell of it.'

Sullivan sniffed the air. His keen nose detected that faint change that had already warned Ross. 'You're right,' he said. 'It's not far away, either. We must be farther off our course than I had thought. What do you make of the current?'

'I can't make it out at all. According to the chart there shouldn't be one here, but there's no manner of doubt that we have drifted a prodigious great way.'

'Have you seen anything at all?'

'Nothing all this watch. Is it eight bells yet?'

'Not quite. I'll get young Derrick to relieve you if you'd like to come below and work over my reckonings again.'

Derrick came on deck in response to a hail, and took over the watch. He was a strong, broad-shouldered boy, and big for his age, but he looked surprisingly young to be on a schooner in those dangerous seas. He was Sullivan's nephew, and they had picked him up at Kuala Lumpur, where his father had had a plantation, and where both his parents had died, leaving Derrick almost stranded. It had been a last-minute arrangement, much against Ross's cautious judgement; but, as Sullivan said, they could hardly leave the boy on his beam ends, and it would have delayed the voyage too much to have remained to make all the arrangements for sending him home to school. So, to Derrick's vast delight, he had been signed



Below, in the saloon, Ross and Sullivan worked over their reckonings

on, and, from the day he had got over his first bout of seasickness, he had worked hard and willingly, earning even Ross's good opinion, a thing which the Scot gave but rarely.

Below, in the saloon, Ross and Sullivan worked over their reckonings: for the third time they came to the conclusion that an uncharted current had swept them a good distance off their course. A hail from the deck interrupted them: Derrick said that he had heard the sound of another ship's engines. They listened: out of the fog there came the distinct sound of a throbbing screw.

'Ahoy, Li Han,' shouted Sullivan. 'Tell Svenssen to sound the fog-horn.'

'Fog-horn instantaneously it is, sir,' replied

the Chinese cook. A moment later the melancholy bellow wailed through the fog. Surprisingly close, on the starboard quarter, came the answer.

'Stop the engine, Li Han,' shouted Sullivan, 'and stow the dictionary.' Li Han went aft without a word, a little distressed at this reference to his treasured dictionary, from which he was teaching himself 'number one first chop' English. The engine spluttered and ceased; the other ship could be

heard plainly moving towards them. 'Stand by to start up,' shouted Sullivan again, and he hailed the other ship. The answer came, 'Who are you?'

'The *Wanderer*. Who are you?'

'The *Santa Maria*. Can I come aboard?'

'Send a boat.'

They heard the splash of a boat being lowered, the gurgle of the oars, and then out of the wall of fog a jolly-boat appeared, not ten feet away.

The master of the *Santa Maria* came aboard. He was a big, immensely fat man, swaddled in two or three coats. 'How do?' he said, shaking hands. 'Can you give me our position? I've had no bearings for days.'

'Come below and have a drink,' said Sullivan, leading the way.

'Mphm,' muttered Ross, looking askance at the huge figure of their guest. In the saloon, Captain Jenkins—he introduced himself by that name, but he did not answer to it very promptly—gulped down three drinks in rapid succession, and poured himself a fourth unasked.

'I'm mighty glad I chanced on you,' he said. 'We've run out of everything except tack and bilge water, and we've sprung a leak that we can hardly keep under with the pumps going day and night. Perhaps you could bear a hand and let us have some stores?'

'Why of course. What's your cargo?'

'Soya fertilizer for Callao from Liao Tung.'

Ross had not spoken since they had gone below: abruptly he said, 'Didn't I meet you one time in Macao, Captain Jenkins?'

'Who? Me? No, never been in Macao.' He seemed a little uneasy, and hurried on to speak about the leak in his ship. Before he went they promised him some stores, and arranged to come over to see if they could help with the leak.

'There's something queer about him,' said Ross, when they were alone; 'I could swear I've seen him before.'

'Oh, there are plenty of rough-necks like him knocking about the China seas, working for Chinese owners. I've seen a dozen like him.'

'Mphm,' said Ross.

Towards the end of Derrick's watch the fog showed signs of lifting. The boy could see the *Santa Maria* fairly clearly: she was an ocean-going tramp, with squat, ugly lines, and the paint scaling off her sides. She was deeply laden, and she laboured in the swell. He gazed at her through his

binoculars, and, as far as he could see in the swirling mist, her crew at the pumps were all Malays. Among other things he noticed that the paint of her name appeared to be much fresher than that on the rest of her. He mentioned this to Ross, who had just come on deck to have the boat lowered away. Peering through Derrick's binoculars the Scotsman said, 'Hmph,' in a satisfied tone, and added, 'You've got sharp eyes, lad. Jump into the boat and keep them skinned when we're aboard her. There's something odd about that craft, or I'm a longshoreman.'

Derrick remained on the deck of the *Santa Maria* when the others had gone below to inspect the damaged hull. The serang was an elderly Malay with an uncompromisingly villainous face: he shook his head when Derrick spoke to him in English, replying, in Malay, that he did not understand the Tuan's language. Derrick was about to repeat himself in Malay, a tongue which he had spoken ever since he could speak at all, when he thought better of it, and remained silent. A life-buoy had caught his attention: there was nothing odd about its shape, but the name on it was 'S.S. *Firefly*, Macao'. The serang followed Derrick's glance, and frowned: suddenly he pointed to the *Wanderer*, and shouted in Malay, 'Get that life-buoy out of here, you sons of pigs.' Derrick saw that he was meant to look round, and he did so. When he turned, the life-buoy had disappeared.

Down below Sullivan was telling Captain Jenkins that the leak would not be serious once the pump sumps were cleared. Ross remained silent and suspicious. By the time they had reached the saloon again Jenkins had started questioning them about their cargo and destination.

'We're on a pleasure cruise,' said Ross abruptly, interrupting Sullivan, who was about to speak.

The breeze from the north-east, which had started to blow in the forenoon, had cleared the fog away, and they were able to take their bearings again. Aboard the *Wanderer*, Ross and Sullivan plotted their course afresh, and they found that they had continued more or less in the right direction while they had been drifting.

'I tell you that ship isn't what she pretends to be,' said Ross, pushing aside the thumbed logarithm tables.

'You've always been a canny, suspicious sort of a devil, Ross: you mustn't take friend Jenkins too seriously. Possibly he is sailing under false colours, but there's many a man does the same when his ticket has been taken away from him. What does it matter to us, anyway?'

'Hmph. Did you mark his crew? There were half a dozen more men on that tramp than he could possibly use.'

'That's true.'

'And soya fertilizer doesn't smell like opium. Did you mark that?'

'No.'

'You were too busy smoking that cabbage-leaf cigar he pressed on you. But I trod on your foot when we passed his open cabin door.'

'And I saw the arms rack. Still, you might carry them if you were going to trade south and east. We've got an armoury, but that doesn't make us into pirates.'

'Whisht, man. Who said anything about pirates? I never committed myself to that extent: all I say is that a large crew of queer-looking scum, a heavy arms rack, and a cargo that smells like opium, is just a wee bit by-ordinary.'

Derrick came in to report the log readings.

'Did you notice anything aboard the *Santa Maria*, lad?' asked Ross.

'Well sir, there were one or two things,' replied Dèrrick, and he told them about the life-buoy. 'And another thing,' he added: 'when the serang came about the stores, he tried to pump Li Han for all he was worth, but I don't think he learnt much.'

Sullivan showed more interest; he shouted for Li Han, who came in and bowed.

'What did the serang ask you, Li Han?'

'Sir, he made inquiries in Malayan dialect concerning whereabouts,' replied Li Han, beaming.

'How do you mean, whereabouts?'

'Where we are about to come from and go to and what for, sir.'

'I see. What did you tell him?'

'Sir, I make replies inconsequential and evasive. Also similarly when he inquires exact strength of crew numerically.'

'Good. Was there anything else?'

'Indubitably yes, sir. The serang is making derogatory remarks, saying that we are poor and without face. But I rebuff him circumstantially and say that our face and prestige is so great that we have huge and lucrative mysterious project in hand.'

'Hm. All right, you can go, Li Han.' When the door had closed, Sullivan said, 'If you're right, Ross, poor old Li Han has given the show away trying

to save our face. There's something wrong about the *Santa Maria*: I wish we hadn't fallen in with her just now. Still, we can keep a weather eye open.'

'But Uncle,' said Derrick, 'if they were pirates, why didn't they attack us when you and Mr. Ross were aboard their ship? We shouldn't have stood a chance.'

'Pirates, my boyo? That's a strong word: you mustn't expect the skull and crossbones nowadays.'

'But you told me that strange things still happen at sea, Uncle Pat,' answered Derrick, going red in the face.

'And so they do. I have heard of men scuttling their ships for the insurance money, and even of men who've done that and been picked up and then thrown their rescuer's crew overboard, and saying that they found her abandoned after the storm in which their own vessel was sunk. But piracy in the old way—well, it's bending the long bow rather too far.'

'Ay,' said Ross. 'Don't worry your head about pirates, lad: go along and work out those navigation problems I set you.'

'Ay ay, sir,' said Derrick, and left them. But he carried with him the firm conviction that the *Santa Maria* was a pirate, and that his uncle thought so too. He was not far wrong, for when he had gone, Sullivan opened the arms chest, and started to clean an already spotless rifle.

'I tell you what, Ross,' he said, threading the pull-through: 'if our suspicions are correct, Jenkins would wait till we've pulled off our "huge and lucrative mysterious project", as Li Han would call it, before he tried any of the Jolly Roger business.'

The breeze freshened at sunset, and the *Wanderer*, without a reef in her sails, scudded cleanly before the wind on her new course. By the morning the *Santa Maria* was out of sight.

III

Some three days later Derrick was below, learning to splice a rope with Olaf Svenssen, the only other member of the crew besides Li Han, when Ross shouted 'Land ho!' from the deck. Derrick tumbled up, and stared at the clear, unbroken sea.

'Where?' he asked.

'On the port bow. Take the glasses.' Through the binoculars Derrick could distinguish a small black smudge among the clouds on the northern edge of the horizon.

'Is that it?' he asked.

'Maybe. We're going to have a look.'

Very slowly the smudge grew more distinct, until at last they could see the jagged rock peaks of the little islands quite plainly.

'If there are sea-otters on those rocks,' said Sullivan, 'we had better not scare them off by getting in too close. We'll anchor here and pull ashore to reconnoitre.'

'How do you catch them, Uncle? Like seals?'

'There doesn't seem to be any accepted way. They are too rare to be



It was an extremely bleak and desolate place

hunted much. Some of the Japanese set traps for them, but we'll go after them with a rifle: it's more sporting, and we can spare the young ones.'

'Providing there are any,' grunted Ross, sceptically.

They left Svenssen and Li Han aboard the *Wanderer*, and pulled for the shore. As they rowed nearer they could see that there were four islands, one some five hundred yards across, and the others much smaller. It was difficult to find any landing place, for the bare rock rose straight out of the sea to a height of ten to twenty feet. As they circled round to find a beach, Sullivan leaned on his oars and stared inshore.

'What do you make of that, Ross?' he asked, nodding towards a smooth round head that was bobbing up and down just behind the backwash of the surf.

'Weel,' said Ross, staring too, 'I dare say it's a common seal, but we might as well follow it up.'

There was a swirl in the water, and the head disappeared, to come up again some distance away. They rowed quietly after it, and in five minutes they found themselves facing a little beach hidden between the jutting rocks. The animal went in on the back of a wave, springing clear of the wash as it broke. In a moment it had darted up the narrow strip of shingle and vanished among the rocks.

'Did you ever see a seal move like that, Ross?' asked Sullivan.

'Mphm. Let's get ashore.'

They climbed to the top of the island, to a peak from which they could see all round. It was an extremely bleak and desolate place; and there seemed to be no living thing on it. A chill wind blew.

'There's another beach down there,' said Sullivan, pointing to leewards, 'and there's this one. You take the far one, Derrick, and I'll scout around, if you'll lie up by here, Ross.'

They separated, and Derrick climbed and scrambled down to a small cliff overlooking the leeward shingle. He settled himself comfortably in a niche and rehearsed in his mind all that his uncle had told him to do. 'You lie up, my boyo,' he had said, 'and have your rifle so that you can shoot without making much movement. If a beast comes up on shore, make certain there's not another one behind it before you shoot. Squeeze your trigger, and make sure the bullet has no corners to go round before you fire.'

Derrick turned up his collar: the rock seemed to grow harder and colder as he lay on it, waiting. At first he stared hard at the sea, hoping for

something to come any minute, but as time went by his attention wandered, and he began to think about the *Santa Maria*.

It was not until the sea-otter was half-way up the beach that Derrick spotted it. His heart leapt into his throat, and he grasped his rifle. The sea-otter was a very much larger beast than he had expected, being almost the size of a seal. It stopped to scratch its head in the middle of the beach. Derrick held his breath and drew a bead on it, aiming between the eyes, so as not to spoil the fur. His foresight was perfectly steady, and his aim dead true. He conquered an instinctive desire to shut his eyes, and squeezed the trigger gently. Nothing happened. He squeezed harder, and still nothing happened. He had left the safety-catch on. He moved an inch to release it, and the sea-otter stopped scratching. He slid his fingers round to find the trigger, fumbled for a moment, and lost his aim. Like a flash the sea-otter vanished into a breaking wave, and Derrick was left, ready to kick himself with annoyance, with a perfect chance missed.

From the other side of the island he heard three shots fired so rapidly that you could hardly have got a blade of grass in between them, as his uncle would have said. After that he heard two more from farther over on the south, followed, an hour later, by another from the beach. It was beginning to get dark, and it seemed plain to Derrick that he was going to go back empty-handed. He scanned the edge of the sea eagerly, but nothing appeared, and at length he heard the whistle that was to call him back. He gave a last look at the sea before getting up: there was nothing to be seen. He arose, and stamped his feet to get them warm. Startled by the noise, four sea-otters that had been lying on a ledge some twelve feet below him all the afternoon jumped down to the beach, and sniffed the wind.

Almost before he had thought of what to do, Derrick brought his rifle up and drilled the largest cleanly through the head. The rest dashed for the sea, and he shot another as it went.

.

For the next week they hunted systematically over the islands, getting good bags every day, until they were sure that the remaining sea-otters were all either young ones or breeding females.

As they rowed back with the last load of skins Sullivan said, 'This will be just about the biggest single cargo of sea-otter pelts that has come to Europe for the last twenty years.'

'Ay,' replied Ross. 'We've got a small fortune on board, but we've still to get it home.'

'I'd like to see any one try to get them away from us,' said Sullivan, tying up to the *Wanderer*. 'We'll stow these, and then we'll lay our course for Yeddo at dawn.'

They were busy stowing the pelts—a difficult and tedious job—when Li Han came below.

'Svenssen begs to report, please, one sail to starboard bow, yes,' he said. 'He reports simultaneously distressing signals.'

Ross reached for his binoculars and went on deck; he came back in a few minutes and said, 'He's right; there's a steamer flying distress signals. She looks like the *Santa Maria*.'

'Does she, then? What's she doing here, two hundred miles off her course?'

'Hmph. That's what I'd like to know.'

'Better have a look-see, anyhow. She might be sinking, whoever she is.'

'Mphm.'

'Well, you might be wrong, and we can't leave her to founder.'

'If you're set on it, then, we'd better make sail.'

'Only thing to do. Don't you think so? You can't leave a ship in distress, can you?'

'Ah weel, I'll not commit myself to an opinion, but I've got a hunch about it.'

The *Wanderer* swung into the wind and tacked for the steamer. When they came nearer they could see that she was the *Santa Maria*, and Ross became very uneasy. In a few hours they were within hailing distance: they could see the Malay crew getting a boat ready, but there was no sign of Captain Jenkins. The boat ran alongside the *Wanderer*, and the serang came aboard with a note.

'Jenkins says he's very ill,' said Sullivan, reading the note, 'and that his serang can't navigate. He thinks there's another leak gaining fast on the pumps, and that the engines are faulty.'

'Mphm,' said Ross.

'We'll get salvage money if we take her into port,' said Sullivan; 'let's go and investigate.'

'I suppose we shall have to. The serang and another man had better stay here. Derrick, you give Svenssen and Li Han a rifle apiece and tell

them to keep an eye on these two: we're going to leave them here as a precaution. Don't let Li Han tell them anything, and don't let any one come aboard until we return.'

The serang and the other Malay were very reluctant to remain, but they had no choice. Derrick took them below to the galley and told Li Han to give them chop while he went to get the arms. Svenssen met him coming out of the saloon. 'Ay ban uneasy in mineself, Mr. Derrick,' he said quietly; 'those Malays got each one a kris in his sarong. Ay don' laike their faces, neither.'

'Nor do I, Olaf,' replied Derrick. 'Do you think there's going to be a shindy?'

'Ay t'ink maybe. Ay seen plenty bad Malays. We better watch out, eh?'

They went back to the galley, where Li Han was trying to talk to the Malays. Li Han's Malay was fragmentary at the best, and what little he knew was of a dialect different from that which the men spoke. Derrick could understand them as well as if they had been talking English. As he listened he blessed the idea that had kept him from letting them know that he understood their language when he was aboard the *Santa Maria*, for when Li Han left the galley, the serang said to his fellow, 'They are suspicious, Thaug.'

'What of it? So were the crew of the *Firefly*, but we cut their throats, and there were nine men aboard her, too.'

'What you say is true, Thaug. And we have the two big men already. It will be quite easy, but we must not let these three fools shoot any of us with their rifles.'

'Just as you say, serang. I shall cut the young one's throat myself: he has something of the look of the magistrate at Mallatengeh who hanged my father.'

'How delightful it is to have pleasures in store, Thaug. But we must ask the Tuan to let us keep the Chinese to cook for us. This fried rice is excellent.'

Derrick's blood ran cold as he listened, but with a great effort he made no sign. Did it mean that Uncle Pat and Mr. Ross were already dead? He thought feverishly, wondering what to do for the best.

'When will the others be here?' asked Thaug, picking his teeth.

'The Tuan said just after sunset. They are to swim round one by one

to the saloon porthole. It would not do to row over all together in a boat, because the pigs will be suspicious when the big men have not returned by then, and they might do some damage before they are killed.'

'How wise the Tuan is, indeed. They will not attack until they are all in the saloon together? There is no danger from the big men?'

'Just so. The Tuan will offer them drinks as soon as they are aboard. They will know nothing in two minutes. Then we shall throw them overboard when we have secured this boat.'

Derrick's heart leapt with relief: there was hope, he thought, if his uncle and Ross were still alive. At this point Li Han came back and started a polite, but aimless, conversation with the serang. Derrick saw that he would hear no more, so he went on deck to think out a plan of action. He walked up and down, racking his brains: he looked at the sun; it was nearer to the horizon than he had thought. There was not much more than an hour left before the sun would set, and the Malays would come slipping through the water with their *krises* ready for killing.

I must do something,' he said to himself. 'If I made the saloon porthole fast they wouldn't be able to get in. But that wouldn't be any good. The first one would swim back, and then they would attack from all sides, and we could never hold them off.'

He turned over a dozen plans, but each one had a fault. At last he called Svenssen on deck and explained the situation to him. At first the Swede said nothing, then a grim smile spread over his face, and he said, 'We have a big rough-house, eh? There aindt no other way, I guess.'

'But that wouldn't save my uncle and Mr. Ross, Olaf. Can't you think of any other thing to do?'

'Ay ban thinking, Mr. Derrick, but there aindt no way out for any of us, Ay reckon. We yoost better kill all we can and trust in luck, eh?'

'It looks as if it would be the only way. I wonder if Li Han would have an idea. You go below, Olaf, and tell him to come up while you keep an eye on the serang.'

When Derrick had told Li Han of what he had heard, the cook said, 'Educated Chinese boy like me is not afraid of death, but find physical violence abhorrent. I go take opium pill, sleep till all finished. You like one piece opium too?'

'No thanks, Li Han. We've got to face it out. Go below and send Olaf up. I've got an idea.'



A brown hand slid over the rim of the porthole

By this time the sun was almost touching the water. There was no time to be lost.

'Olaf, I've got an idea,' said Derrick; 'come along with me. It's our last hope. I'll explain as we go.' He ran to the saloon, gathering a coil of fine rope as he went. 'Bring a couple of belaying pins,' he shouted, as he tumbled down the companion way. In the saloon he flung himself on the furniture, clearing a space to roll back the carpet. 'Look, Olaf,' he said as he worked, 'here's a trap-door down to the hold. We must get it so that I can open it at once. Are all the hatches battened down?'

'Why, no. There's the aft——'

'You go and make it fast. I'll manage this. Leave me a belaying pin, and show a leg.'

Derrick was left alone; in the rapidly fading light he rolled up the carpet covering the trap-door, lugged the precious furs into a conspicuous

position, and rearranged everything to look as natural as possible. He had hardly finished stowing the rope and belaying pin, when a faint scrabbling noise caught his ear. He crouched in the shadow by the porthole, grasping the heavy belaying pin. A brown hand slid over the rim of the porthole. Derrick heard the man grunt as he swung himself up. The Malay's head and shoulders wriggled through. Derrick held his breath until the man was half-way into the saloon, then, with all his force, he brought the belaying pin down. There was a crack as if he had driven a cricket ball, and the man fell into the saloon, three parts stunned. He grabbed for his kris, but Derrick jumped on him and hit him again. The Malay writhed under him, and got a wrestler's grip on his forearm. The man was strong, and he was fast recovering from the blow. Derrick fought madly, but he saw the gleam of the raised kris. Olaf came in; he picked the Malay up as if he were a child, and dashed him down again with appalling force. The Malay lay still in a crumpled heap. Derrick staggered to his feet, groping for the rope.

'Quick,' he said, 'before another comes. You stand by the porthole, and I'll tie them up.'

Derrick had barely closed the trap-door, through which he had shoved the bound Malay, when another hand appeared at the porthole; the head followed it, and Olaf struck. He seized the Malay by the hair and flung him into the saloon: Derrick roped his hands and feet together and rolled him down into the hold. They waited in silence: for what appeared an age nothing happened; then they heard a whisper in Malay.

'Are you there, Kelan?'

Derrick answered softly, 'Yes, come quietly.'

There was another thud, and Derrick closed the trap-door again. Olaf grinned at him in the half light.

'We making out okay, huh?' he whispered.

'There's a chance now,' replied Derrick.

Two more Malays came and went down to join their fellows. Then three came at once, whispering together. The first came through confidently, and Olaf took him so fiercely by the throat that he could not utter a sound; then he struck him on the back of the neck with the edge of his hand, and the man fell silently: he served the second in the same way; but the third asked for a hand up, so Derrick reached out and took his hand, heaving him up. Suddenly the Malay realized that something

was wrong—the hand was white. With his arm just through the porthole, he reached for his kris, and stabbed as fast as a striking snake. The knife pinned Derrick's forearm to the wood, but Derrick hung on for a second, just long enough for Olaf to grip the man's hand and pull him through. The Swede dealt with him, and turned to help Derrick, who was half fainting with pain. He wrenched the kris out of the wood and whipped his handkerchief round Derrick's arm above the elbow, tying it as tightly as he could.

'You aindt much good now,' he said.

Derrick forced a grin, and said, 'I can still shove them down. Hit 'em hard, Olaf.'

'Good lad,' replied the Swede, and turned to the porthole.

After that they were kept very busy. A head appeared; Olaf cracked it and flung the body over to the trap-door, where Derrick pushed it down and closed the lid. Derrick's arm was hurting badly, but the excitement kept him from noticing it too much. He lost count of the men at last. There came a long pause, and Olaf said, 'Well, Ay guess there aindt no more to-day. How your arm feels, eh?'

'Not so bad, thanks. If that's the lot, we'd better go across and see to my uncle and Mr. Ross. Let 's get——'

He broke off and spun round. The serang and Thaung stood in the doorway, covering them with their own rifles. Olaf flung his belaying pin and leapt: Thaung fired, and Olaf slumped down on the floor. The two Malays stared about them in the twilight, trying to grasp what had happened. Derrick saw that he would be shot down if he moved: he stood still, waiting for the end. If only Li Han had kept his wits about him, he was thinking, when above his head he saw the Chinese cook kneeling on the skylight, trying desperately to open it. He had a steaming cauldron by his side.

Derrick knew that he must gain time. Suddenly he shouted out in Malay, 'Serang, wait for a moment. I will show you a great treasure.'

The serang started, and replied, 'Where? Show me at once, or I shall slit your throat.'

Derrick saw that Li Han had opened one of the catches. He started on a long direction. 'You must go down to the forrard bulkhead——'

Li Han raised the last catch and silently raised the skylight. He stood just above and behind the Malays. He lifted the great cauldron. 'Excuse,

please,' he murmured: and poured the boiling water on to their heads. The serang's rifle went off, splintering the wood behind Derrick's head. Li Han leapt down on Thaug, knocking him out: Derrick caught Thaug's rifle, shot the serang in the shoulder, shouted to Li Han to raise the trap, and bundled the still struggling man down into the hold. He sat down, gasping to regain his breath. Olaf groaned, and sat up, rubbing his head: the bullet had nicked the side of his head, temporarily stunning him: now, apart from the nasty cut, he was all right.

The rest seemed simple by comparison. As they rowed over to the *Santa Maria*, Derrick asked, 'What became of your opium pill, Li Han?'

'Extreme terror and timidity prejudicial to exactitude,' replied Li Han, beaming. 'In my haste I mistake liver pill for desired article. Hence unusual valour and agility. But regret washing-up water now total loss.'

They crept aboard the *Santa Maria*, but their caution was unnecessary, for when they burst into his cabin they found Jenkins three parts drunk on his bunk. Ross and Sullivan were lying gagged and bound on the floor. Jenkins dropped his gun as they came in, and turned very pale: in his terror he was a pitiable object.

As the gag came out of Sullivan's mouth he fetched a deep breath, and said, 'Well done, my boyo; we'd given you up long ago. Is the *Wanderer* all right?'

'Why, of course, Uncle—you left me in charge of her, you know. We disposed of the Malays in the hold.'

'Good lad,' said Ross, tying Jenkins's hands; 'I hope you batted them down. They're sure to steal the ballast otherwise.'

.

Ten days later the *Wanderer* sailed out of Yeddo harbour, leaving Jenkins and his crew behind them in prison.

'I told your pig-headed uncle that there would be trouble if we went aboard the *Santa Maria*,' said Ross to Derrick, as they leaned over the rail.

'Whick did you go then, sir?' asked Derrick.

'Aha, my boyo,' shouted Sullivan from the wheel; 'it was the salvage money he was after; that's why he risked his Scotch neck. Ross, you're nothing but a yellow-belly. D'ye hear me? A yellow-belly. But I tell you what; when we were in Yeddo court-house I had an idea——'

'Mphm,' said Ross, winking at Derrick.

OUTLAW OF THE SHEEP COUNTRY

A Tale of the
Australian Dingo



by
IAN
MILLER

I

A WIND blew from the east across the sand-ridge country where Queensland, New South Wales, and South Australia meet. It broke the roly-poly plants from their dry stems and tumbled them like giant footballs along the plain until they stopped against the dog-proof Border Fence. The sand lifted and whirled in thin wreaths over the top of the ten-foot barrier. By evening the wire netting was out of sight. Next morning a boundary rider on his second patrol of the week swore heartily as he saw the spade-work before him. Then his keen eyes picked out a single set of dog-like tracks on the inner slope of the new sand wall, tracks bigger than the palm of his hand. They pointed eastwards—away from the untamed country into the land of peaceful sheep runs; and he swore again, for the dog-proof fence had failed its duty. A marauder was loose among the flocks.

This was the coming of Mityin, on the back of a drought that scorched the grass of the sand-hills to its roots, dried up the water-holes, and left the bones of emus, kangaroos, and countless rabbits bleaching among the shrivelled sandal-wood and hop-bush scrub. A thin trail of mangled fur and stained feathers marked the line of the solitary raider. 'Mityin' is Wind. The wind brought him, and like the wind he passed, slinking warily along the baked clay pans where the red dust devils puff up and dance like mad dervishes, gliding unseen through the grey flats of rasping cane-grass, across the yellow ridges, and below the dull mulga trees. He drifted easily by Mt. Shillinglaw, over the Grey Range, through the Bulloo Downs and Currawinya until he reached the Kungie sheep run on the Paroo; and stayed.

Jay O'Byrne, jackeroo on Kungie, was the first to learn of Mityin's arrival, in a fashion that set the old hands talking over every camp fire

west of Dynevor Station. The Paroo was no longer a river. Its black soil banks were friable and loose and gaping in wide cracks. Its bed was a succession of shrinking pools, the shallower ones already churned to treacherous slush that gripped the drought-weakened sheep as they came to drink. There they died, unless Jay in his daily scouting hauled them free and set their trembling legs on firm soil. An unending labour, for thirst drove them straight back to the pool they were accustomed to, to be caught again.

Jay O'Byrne patrolled from pool to pool along the river bends under the fringe of drooping box and coolibah. The air was stifling and so still that not even a gum-leaf fluttered, and his horse's hoofs made no sound on the bare, crumbling soil. So he came unannounced to the bank overlooking a narrow water-hole and halted by the white-powdered bole of a river gum. A three-quarter-grown red kangaroo stood at bay in the shallow pool, facing a splendid dingo—Mityin, the killer. He was tawny-grey, with white points and a white chest, unusual for a wild dog and indicative of a strain of Alsatian somewhere in his ancestry. His size bore that out, too, for he stood almost thirty inches high at the shoulder and measured about seventy from muzzle to tail-tip.

This was the end of a deadly silent hunt. The kangaroo's russet flanks were streaked with sweat and heaved distressfully, and more than one place showed long, bleeding gashes; but his head remained up and his small fore-paws kept guard before his chest. Exhausted, and finding escape impossible, he had followed the instinct of his kind and 'bailed up' in the river, where water would give advantage to his superior height and upright carriage. Many a cunning dingo—and prized hunter's dog too—unable to defend himself when swimming, has been ripped by a 'roo's' powerful hind legs and held under water until drowned. Mityin's lips were drawn back viciously from his white wolf's teeth. From head to tail his body was tensed as he moved forward, one stiff leg at a time. The hair on his shoulders lifted in a menacing ruff. Even now he made no sound. The dingo, like his wolf cousin, is a silent hunter.

The finish was not long delayed. Regardless of the kangaroo's weaving forepaws, Mityin feinted swiftly, swerved aside to the flank, and leapt full at the throat. His jaws met and ripped away the flesh in one slashing bite. Then he fell clear, to leap once more on his dazed, pain-stricken quarry from behind. This time he clung there and dealt slash after slash, always

at the throat, while his victim jumped to and fro and shook himself vainly. In a minute it was over. The kangaroo lay kicking weakly in the muddy water, with Mityin mouthing and shaking its fur in silent victory. It was done with a savage dexterity that told Jay O'Byrne, unfamiliar as he was with dingo ways, that Mityin was a master killer.

There were tales of dingoes in the country farther west, of course, but Kungie—and all the sheep country—had been cleared of them years ago, though there were still a few stretches of dog netting to be seen; but it is hard to pick the truth out of back-block tales. The battle left Mityin facing the bank. Some sixth sense of danger, or the vague stirring of an air current, carried to him the warning of an enemy. He looked directly in the face of the watcher, and showed his teeth in a snarl. Jay saw the lift of his hackles and felt surprised, for the dingo has a coward's reputation in his dealings with man. Even a coward's blood, however, will some time produce courage, and in Mityin the strain of a stray Alsatian grandsire overcame the dingo spirit. He kept his snarling guard while Jay kicked foot from stirrup and freed stirrup-leather from saddle. With such a weapon the bushmen run down and kill many a lamb-killing fox. Here, though, was no cringing yellow lamb stealer. As Jay swung the heavy iron and urged his horse down the river bank Mityin advanced a step to meet him. He snapped in fury. The thoroughbred pony, already quivering nervously at the scent of blood and the sprawling body, shied away suddenly, and Jay, unprepared, with only one stirrup, was thrown from the saddle. As he fell the blunt metal swung heavily on his right temple, making a long gash that bled freely.

Half dazed, he stood up again and tried to catch the dancing pony. She eluded him, wheeled, and galloped off. Jay took a few uncertain steps, to stop hurriedly at Mityin's snarl. The tawny killer stood with one fore-foot poised, his whole body taut as a bow-string. Drops oozed from the corners of his mouth. Jay could see the bloodshot corners of his eyes. Here on foot on level terms with him Jay felt that he might be attacked at any moment. Desperately he tightened his grip on the weighted leather thong, and reached slowly with his left hand for a handkerchief to staunch the flow of blood from his forehead. Then he began to retreat, step by step, watching warily in case of a sudden charge. Mityin stood poised on three feet and let him go.

With relief Jay stumbled backwards up the steep bank. Not until he



The tawny killer stood with one forefoot poised, his whole body taut as a bow-string

was out of sight over the rim did he dare to turn; then he went quickly, with frequent looks behind. But the gash in his temple made him dizzy. Before he had gone half a mile he was compelled to rest against a tree. Then, for the first time, he became aware of Mityin following him, stopping to nose in the dust and lick the blood spots that dripped from his soaked bandage. Tales of the blood-lust of dingoes and wolves came to his mind. He got up and began to run. But he was in no condition for such exertion and soon fell from sheer exhaustion. As he lay on the ground Mityin trotted up to within a few yards and circled round, snapping at him viciously. With a great effort Jay scrambled into the thin branches of a nearby mulga.

So Jay sat as the afternoon wore out, wedging himself into a crotch. He rebound the wound with strips from his shirt. Mityin swung to and fro on the ground, snarling up at him. After a time he strolled off, but not far, and as soon as Jay moved to climb down he came back, sniffing and scratching round the butt and snarling at the least change of position.

After sunset he was still there, a pair of eyes in the dark. Jay, clinging to the thin branches, wondered what would happen if he dozed and slipped.

About ten o'clock a long 'coo-ee' sounded some distance off. Mityin whimpered uneasily at Jay's eager shout and slunk away as two men from the homestead rode up. They laughed uncontrolledly as he recited his adventure, branded him a 'new chum', and chaffed him unmercifully. Dangerous dingoes were an old hatter's tale, and anyway, there were no dingoes on Kungie. Then out of the night floated an unmistakable, mournful, drawn-out howl as Mityin stopped on a sand-hill a mile away and greeted the rising moon. They went home in doubt. Next they read the whole story in the dust tracks, and no longer doubted.

The Boss looked grave. 'We're going to lose sheep if that animal stays on the run. He's a killer, and if he gets among a flock he'll not stop while one of 'em is alive. There's a bounty of ten pounds to the man that brings his scalp in within a fortnight.'

The men took to carrying rifles and strychnine bottles on their daily duties, but the fortnight passed and Mityin was unhurt. There are two hundred thousand acres of mulga scrub, bare plain, and bushy sand-hill on Kungie. The intruder settled in and made himself overlord of it all; and, like an imperious ruler, exacted toll. Lightly at first. A sheep was found here and there with its throat torn open. Fifteen were counted in as many days. One morning Jay O'Byrne's fighting Airedale roused Mityin from the soft saltbush beds on the dry floor of Lake Kungie. Man and dog ran him for a level mile at top speed. Then Jay lost the hunt in the fringing thickets of coolibah suckers, and the terrier never answered his whistle either then or afterwards. Jay scored another mark, a heavy one, against the wild dog.

They rubbed strychnine into the body of every dead sheep, and all they poisoned was scavenging eagles and foxes. Mityin never came twice to the same kill. Then Morris, the station handyman, riding along the bore-drain that carries precious artesian water over miles of the flat, thirsty country, saw a sight that sent him back to the homestead in a hurry.

'That dingo's as cunning as the devil,' he panted. 'I could see his tracks as clear as mud. I tell you he *rounded up* then: sheep in the south-west corner of the lambing paddock, and when he got 'em against the fence he just slaughtered 'em. Must have been last night. There's twenty-nine ewes lying there with their throats torn out, and never another bite out of

'em.' He looked at Jay and added, 'Reckon I'm glad it was you and not me that met him. He's a *killer*.'

The Boss swore. 'You'd better take the lorry out and get the skins, Morris. That's fifty sheep gone, and it looks like being a hundred soon. We've got to get that dog somehow. You couldn't find enough men to drive this country; there's too much cover. We might ride for days and not see him. The reward's up to thirty pounds. Jay, you ride across to the blacks' camp on Tinnenburra and get Jimmy Ningaan to come over. Tell him I'll give him twenty shillings a week and tucker. He's the best tracker and hunter around here. You can stay with him on the job until you bring in the scalp of this blood-thirsty warrigal.'

So black and white together camped on Mityin's trail, and Mityin rolled in the sun among the sand-hills and laughed at them.

II

Jimmy Ningaan started his campaign in the time-honoured way, with poison. He took the body of a sheep and with it dragged a trail across behind the dilapidated station Ford. At intervals he stopped to hack off a quarter. Every quarter he slashed deeply with his knife and rubbed strychnine thoroughly into the gashes. Six of these trails he laid in different sections of the run, more by way of testing Mityin's habits and intelligence than in expectation of results. The black fellow was studying his task.

There followed a heavy mortality among the foxes. Mityin's broad footprints showed beside two trails on the first night. He ran beside the drag until he reached the poisoned baits, and then defiled them. Thereafter he left them entirely alone. Then Jimmy availed himself of his privileged position and demanded two dozen tins of sardines from the cook, promptly stowing most of them away in his tucker-bag for private use later. The others he carried up to the killing-yard and began a new scheme, initiating Jay into the secrets of the trapper's art. He removed his ragged shirt and dirty dungarees and had Jay hose him well, then rubbed himself with gum leaves.

'Smell belong me all gone now,' he explained. His hands and arms he dabbled on the body of a newly killed sheep. On the laid-out skin he mixed together the warm entrail fat and mashed sardines and a liberal quantity of strychnine. Finally he boiled some old two-ounce tobacco tins, drove a wire peg through the bottom of each, and filled them with the

delectable mixture. He set them aside to harden. His shrunken face creased into a gap-toothed smile as Jay laid the baits later in the day, each tin sunk till its lip came level with the ground, and the peg driven firmly in underneath. 'All warrigal fella come for this tucker,' he assured Jay. 'Tin no can move; easy to find when poison killem dead.'

He was right, too. Forty baits were laid and thirty-five foxes lay rigid beside them in the morning. Mityin came. His tracks in the sandy dust showed where he had circled several of the tins at a cautious distance. He came again on the night following, enticed by the rich odour that drifted close to the grass with the evening wind. He dallied close by, and at length ventured his red tongue to lick the bait. One lick only. The too-open situation roused his suspicions. He scratched round the tin, trying to lift it to carry it to the shelter of the hop-bush thickets. So five minutes passed. The strychnine suddenly gripped him in the stomach and knocked him sprawling and kicking in a heap. Desperately he tried to work his cramped limbs. As the paroxysm left him he staggered weakly to his feet and tottered away. A second and third convulsion kicked his feet from under him, doubling him with pain. His lips were drawn back from his teeth in a rigid grin, his limbs stiff and almost helpless. When he could stand again on his trembling legs he scratched feebly at the grass around. The dry spikes stuck in his throat and the bout of coughing that followed turned to a tearing sickness. With widespread feet he hung on weakly while retching ejected the poison from his tortured stomach. Then he set off slowly for the farthest section of the run. That night, for the first time since his coming, no sheep were killed.

It had been a close call. Fortunately for Mityin the dose he had swallowed was a small one, though Jimmy Ningaan's mistake was one of psychology, not quantity. The story of the night's happening was plain to read in the trampled dust and torn grass, and Jimmy realized that baits were useless henceforth.

Mityin refused to go near another lure. He took his meat alive, every night from a different point of the compass. Traps, which Jimmy tried here and there, he doubled away from, no matter how cunningly they were hidden. Jimmy took to riding about the run apparently aimlessly. One day he went off alone, and after that did nothing for a week. Jay O'Byrne snorted his annoyance at such laziness, but Jimmy shrugged his narrow shoulders.

'You wait two or three days. Only one way to catch this fella now.'

On the eve of the full moon he became active again. He cleaned his own rifle and made Jay borrow a dull blue-barrelled .303 in place of his own gleaming weapon. They went out on foot just before dusk, Jimmy with a beautiful red kelpie bitch from the kennels on the lead. Jay expostulated angrily.

'You can't take her, Jimmy. Kelpies aren't hunting dogs anyway. My airedale couldn't put up a show against this warrigal, so what chance has Bess got? Besides, she's the best worker of sheep on the place, worth two men easily, and what the Boss won't say if anything happens to her!'

Jimmy smiled his wizened smile. 'Warrigal no killem this mary-fella. Alla time makem friends.' He led the way to a spreading whitewood tree on the crest of a sand-ridge about five miles from the homestead. Close cover of sandal-wood and hop-bush grew on either side, but for twenty yards around the tree only one or two knots of spinifex broke the smooth sand. Up in the branches Jimmy had made a narrow, well-hidden platform twenty feet from the ground, a considerable height in that country of scrub growth. They passed an uncomfortable night on the hard, knotty branches. Half-way between the silver tree trunk and dark hop-bush fringe the red kelpie crouched, fastened by her lead, whimpering uneasily at intervals. A pair of marauding foxes crossed the open space contemptuously when they saw she was tied. An emu stalked loftily by with long neck weaving to and fro in curiosity. The moon sank and the open space grew dim before dawn.

As the morning sun flung a red margin behind the mulga scrub Jay stretched his sore muscles and reached for his long-denied cigarettes.

'Your plan's no good, Jimmy. We might as well have had a good sleep in bed.'

'Dingo come all right,' the aboriginal asserted. 'We no see, no hear him, but Bess know. He no see us and that plurry good job.'

They scouted round carefully, and quickly found tracks impossible to mistake where Mityin had tramped restlessly backwards and forwards through the hop-bush, and the smooth, fur-etched hollow under a low sandal-wood where he crouched, watching the decoy.

Next night the hunters were in their place by sunset, tying Bess with soft rope that would make no sound as she moved. Within half an hour

the full moon swung up, a crimson globe that shot a line of fire behind the thin black mulga stems. From the sand-hills on their right, perhaps two miles away, came a long howl that brought the kelpie to her feet and set her barking in answer. Blood to blood, for the kelpie strain was fathered by warrigal dingo. Jimmy nudged Jay softly, and they settled down to wait. Neither dared move. The time dragged on without sign, but somewhere in the shadowy tangle of brush they knew Mityin was waiting too. A rabbit lolloped aimlessly towards the dark patch of a sandalwood on the verge. They watched him under the clear white moon. Then in a blink of an eye he was gone, turning a somersault in his haste, his fur stiff with fright; and for a while there was no other movement in the clearing.

The kelpie bitch stirred and whined gently. She stood up, facing a different point of the hop-bush, and walked as far as her lead would allow. Her red coat took on a gleam of silver in the moonlight as she waited trembling, eager, alluring. A grey shadow moved beside a spinifex clump. Mityin, lord of the sand-hills, had come to his love feast.

Bess barked, low and soft. Her tail waved slowly as she leaned on the

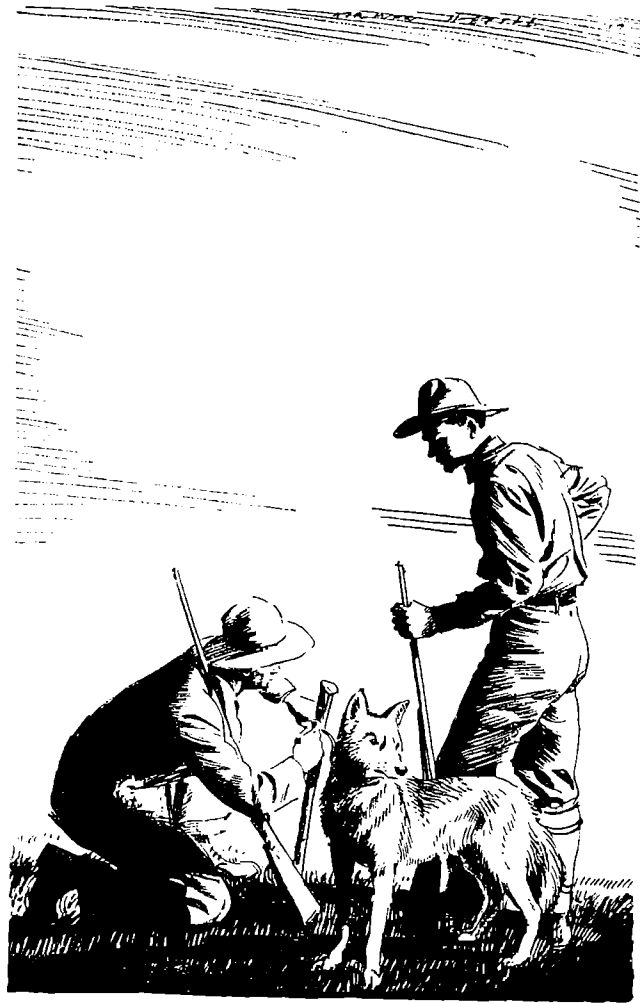

Tying Bess with soft rope that would make no sound as she moved

leash. Deep in Mityin's throat came an answering whimper, eloquent and tender. He began to walk towards her, royal and masterful.

Two rifle barrels glinted bluely between the leaves, one held deadly straight on that grey-tawny shape as he crossed the open sand, the other waving uncertainly from the mark. Jay drew in a breath of admiration for the magnificent outlaw that had laughed at them single-handed all these weeks. In that second he felt the dauntless spirit of the lonely invader, and the meanness behind the aboriginal hunter's cunning plan. Swiftly he made his decision. His rifle swung firmly into line as Jimmy Ningaan softly breathed the count. 'One—two——'

Crash! A shot rang out on its own, and Mityin leaped with pain as the bullet seared his flank. Crash! A second bullet scattered the sand under his nose, and like a thing on wires the betrayed dingo leaped back among the sheltering hop-bush. Belly to earth, he sprinted away from the treacherous clearing, heedless of the tearing bullets that Jimmy Ningaan shot wildly after him and with a low whine in his throat for the thought of the kelpie Bess and her shining red coat.

Angrily the hunter turned to Jay.

'You all plurry big fool, eh?' he spat. 'Why you no wait longa number three?'

'I'm sorry, Jimmy. I lost my nerve, I guess,' Jay O'Byrne said contritely.

'Now we losem thirty pounds, too right,' the hunter spoke with savage disgust. 'Dog no come back this time.'

'Then our sheep will be safe enough, anyway,' Jay answered. Jimmy Ningaan spat on the sand; but Jay was glad as he walked over to where Bess crouched whimpering in sudden fear.

'It's all right, lass,' he whispered as he bent down to pat her. 'Whatever Mityin did he was a fighter and deserved a chance. That was a dirty way to finish him. You and I, we couldn't play him a shabby trick like that, could we?'

Bess reached out her soft red tongue to lick the comforting hand as though she understood.

Away in the sand-hills Mityin stopped to lick the raw scrape along his side, never knowing of the careful aim behind that warning shot. Eased, he turned his nose into the warm west wind, and set off in his long tireless lope. He was going back to his own country.



THE old grey fox stole through the wood,
For a-hunting he would go;
But he pricked up his ears when he heard the horn,
And he knew on that bright and wintry morn
There were others who would a-hunting go,
And a bad 'un to beat was Huntsman Joe.

So out of the wood away he stole,
For a-hunting they would go;
With a flick of his brush at the 'Garn away!'
'By gum, there'll be bellows to mend to-day;
For the old grey fox is a good 'un to go,
And we're in for a gallop,' said Huntsman Joe.

So over the meadow and holding plough
A-hunting they did go;
With the grey fox setting a spanking pace,
While the galloping pack behind him race.
'Sit down in your saddles; you'll have to go
To be in at the finish,' said Huntsman Joe.

A lad was riding a chestnut mare
When a-hunting they did go.
He rushed his fences at breakneck pace
Like a fool at the start of a steeplechase.
'He'll be down in a minute—I told you so.
He was asking for trouble,' said Huntsman Joe.



The old grey fox he led 'em a dance
When a-hunting they did go;
For he swam the Merrowby brook in flood,
With its twenty foot and its banks of mud.
'It's in or over, so here we go;
And begad we're over,' cried Huntsman Joe.

The old grey fox was draggled and spent
When a-hunting they did go.
But the fences were stiff and the horses done,
And the field grew smaller as one by one
They came to grief. 'And it looks as though
It's a fight to a finish,' said Huntsman Joe.

But Joe alone with his weary pack
A-homeward he did go;
For the old grey fox he got to the ground
Not a length ahead of the leading hound.
'You old grey devil, you're game, and so,
To our next merry meeting,' said Huntsman Joe.

R. B. v. W.

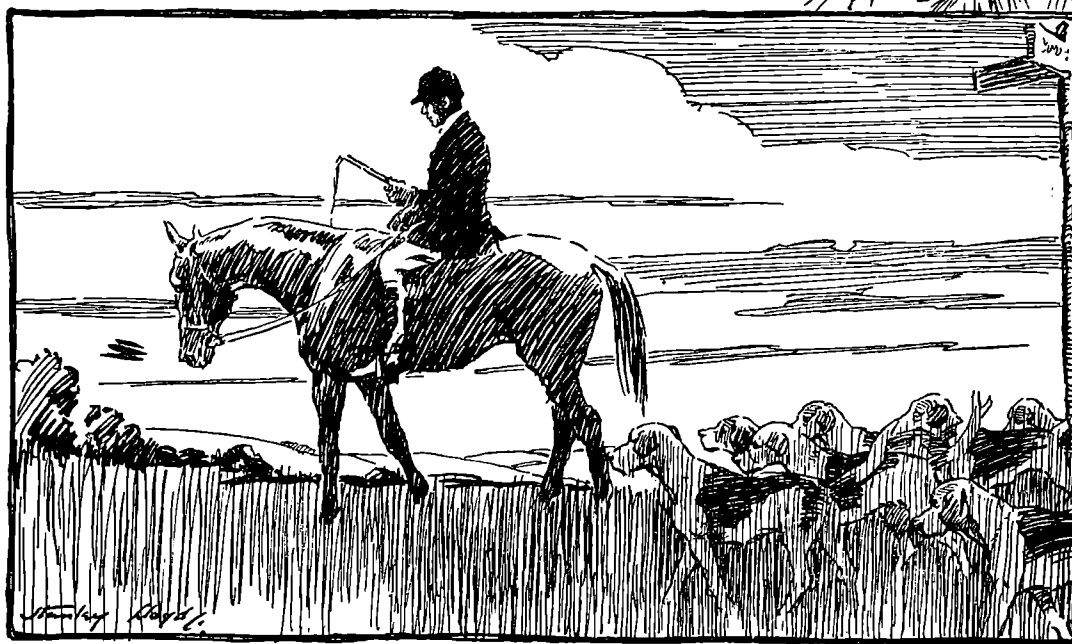

THE ARMY OF TO-DAY

By LIEUT.-COLONEL DONALD PORTWAY, R.E.

IT is now the agreed policy of Great Britain both in peace and in war to adopt a limited measure of compulsory military service, and this policy will undoubtedly be continued so long as it is necessary to protect the tradition of freedom that means so much to the whole Anglo-Saxon race. It is, moreover, decided that all future officers of the Army must enter through the ranks and share the common companionship of the barrack-room. The star, and even the field-marshal's baton, are within the reach of every private soldier. No exception is to be made to this rule of common entry through the ranks save in the case of such specialist branches as the Royal Army Medical Corps.

It is therefore important that the boy who is to be called upon for Militia service in due course should know something of the methods of training in the Army and of the work of its various branches.

As many Militiamen have already discovered, the Army is no longer an institution where the old-time sergeant-major holds sway with his narrow outlook and harsh insistence on obedience to quite unreasonable commands. This is not to suggest that the recruit lives a *dolce-far-niente* life with his corporal bringing him an early morning cup of tea, and where he gets up at his leisure and lives on velvet; but everything is directed towards the vital purpose of training, which is above all to foster habits of self-control, loyalty, and a high sense of honour. The main object is to produce efficient leaders and troops who are hardy and intelligent, skilled in the use of their weapons, and ready to accept responsibility. The first essential for this is a healthy body, and physical fitness is above all demanded. The soldier gets four solid and well-cooked meals a day, and physical training and athletics, together with games of all kinds, are, above all, encouraged. All sorts of athletic equipment are provided, and the soldier is furnished at no cost to himself with ample games facilities that could only be obtained in civil life at much expense. Football, hockey and cricket pitches, tennis courts and so on exist in abundance in the army to-day, and at all the principal stations swimming baths, many of them heated and open all the year round, are provided.

Decentralization of command due to modern weapons throws ever-increasing responsibility on junior leaders, and every effort is made both to discover the man with qualities of leadership and to foster those qualities. The militiaman in peace as in war is studied from his first arrival at the dépôt, and if he shows these necessary qualities he is sent, after a few weeks of early training, to an officer-cadet training unit—generally described as an O.C.T.U.—where a definite course of study of from four to six months leads to commissioned rank.

Leadership depends on simple and straightforward human qualities, but above all the leader must have the confidence of his men. In order to gain this he must know his job, he must possess a sense of humour, he must be cheerful in the face of danger, and he must take a pride in his command. Tact and a knowledge of human nature are vitally necessary so that the best can be got out of those under him. The leader who nags or who sets a low standard of personal honour will never go far.

All operations of war involve the use of weapons, and all plans must fail if the weapons are not effectively employed. In war the fighting man needs many of the qualities of a primitive hunter, and peace-time conditions call into play such qualities only to a very limited extent. It is sometimes said that the modern infantry soldier must be a cross between a game-keeper, a poacher, and a policeman. Certainly he must learn to observe, to conceal himself, and to listen in the spirit of the doggerel:

*A wise old bird sat in an oak.
The more he saw the less he spoke.
The less he spoke the more he heard.
Soldiers should imitate that bird.*

The modern Thomas Atkins must be able to remain motionless, and to appreciate instinctively the protection afforded by ground and by natural cover. Much stress is laid on night-work now that aircraft have rendered the movement of considerable bodies of troops by day a matter of some danger.

The Army is now provided with a wide range of up-to-date equipment, and as in general there is a wide choice among the branches that the militiaman can join, he should know something of the work of each of the various arms.

The infantry is still, in spite of all mechanical innovations, the back-

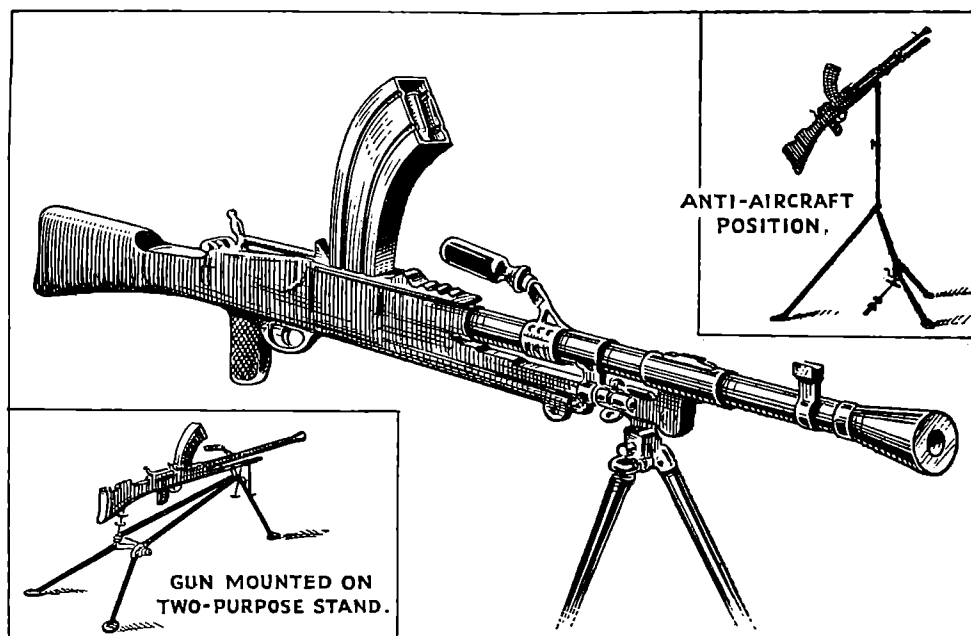

Bren gun

bone of the Army, since all success in war must in the end be confirmed by infantry. But infantry to-day is very different from what it was, even two years ago. Its weapons now include a large number of Bren guns, which are light machine-guns that have altogether replaced the Lewis gun, which was invented in the war of 1914-18. The Bren gun is a formidable weapon that can be fired from bipod mountings, and a single gunner can use it for single rounds or for bursts of fire. It can also be fired from a tripod mounting for use in a fixed direction by night. An extra leg is embodied in the mounting for use against aircraft. For this a percentage of tracer-bullets can be employed so that they can be seen in flight, and the gun is then used much as a fireman uses a hose-pipe. Another weapon at the infantryman's disposal is an anti-tank rifle, which is a single-shot hand-operated weapon whose bullet can penetrate the armour of a light tank. It can be maintained and fired in action by one man, but if the rifle and ammunition have to be carried for any distance they constitute a two-man load.

In the infantry battalion are also two types of mortar which give plunging fire suitable for engaging an enemy protected by cover. The 2-inch mortar fires a light bomb containing either smoke or high explosive,

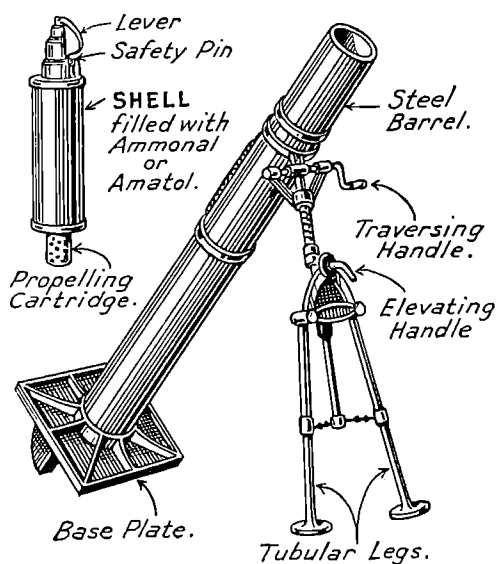

Trench mortar

its chief use being as a smoke-producing weapon for offensive action. It is small and easy to conceal. The 3-inch mortar is a far more formidable weapon, but it takes three men to carry its various components, and as its bomb is heavy the provision of ammunition at a distance from its truck is difficult. Other weapons carried by the infantry are the rifle and bayonet and the hand-grenade.

Each infantry platoon has its own truck, which carries the equipment, so that the soldier marches without the 'Father Christmas' load with which his parent was burdened

in the war of 1914-18; and a special feature of the modern infantry battalion is the armoured machine-gun carrier which enables teams of machine-gunners to cross bullet-swept country with speed and safety. Each battalion has also a pioneer platoon for simple field-engineering tasks, while an anti-aircraft platoon is provided in which Bren guns are mounted on trucks so as to be able to fire at enemy aircraft while the trucks are in motion.

The word cavalry conjures up a vision of soldiers with lances or sabres on picturesque palfreys, but actually very few British cavalry regiments have now a single horse in their possession. Most of the cavalry regiments have now been merged, together with the Royal Tank Regiment, into the Royal Armoured Corps. In this Corps the cavalry spirit of dash and determination survives in a new form. Mechanized cavalry consists mainly of light tanks together with Bren carriers, and these regiments enable the usual protective and reconnaissance role of the cavalry to be carried out at a much greater radius of action than was possible with horsed formations. Horsed cavalry still have their value, as they can work in regions—flooded fields, for example—where tanks would be useless, and their power of searching the ground is greater. Armoured cars sometimes work in close co-operation with cavalry, whether mechanized or horsed. The Royal Tank Regiment is provided with much heavier and better armoured tanks

than those used by mechanized cavalry, and their offensive power is a good deal greater. These tanks are very formidable in attack, but are not intended for action against heavily fortified positions such as the Siegfried or Maginot lines. Another type of tank, slower but more heavily armoured, is intended for close co-operation with infantry in the attack. Although armoured formations are so formidable in the attack owing to their great mobility and their power to deliver a considerable volume of aimed fire while in movement, they have also many enemies. All armies possess a large number of anti-tank guns and rifles for defence against tanks; special anti-tank mines are also available which are exploded by the tanks passing over them, and obstacles such as thick woods, large houses, trenches of more than a certain width and depth will hold them up. Rivers are a specially valuable tank obstacle, as no really satisfactory tank has yet been devised that will swim rivers.

The Royal Regiment of Artillery has a wide range of weapons in use, varying from the little anti-tank gun firing its light shell to the gigantic fortress-monster firing a huge shell, 15 inches in diameter, an enormous distance. Every time such a 15-inch gun is fired with full charge, £1,000 has disappeared in smoke and flame! The accuracy of these fortress guns is remarkable; under ideal conditions a 9.2-inch gun firing at a target 10 miles away should put a series of rounds fired with the same sighting into a circle 12 yards in diameter. Enormous ranges are possible under special conditions—in 1918 the German 'Big Bertha' used to shell Paris at a range of 76 miles, but the shell only weighed 265 lb. with a small bursting charge. The artillery equivalent for the infantry mortar is the howitzer, which fires its shell with comparatively low muzzle-velocity and high trajectory, thus enabling these shells to search ground behind cover which the guns with their flat trajectory could never reach. The howitzers are just as varied in their size as the guns, and owing to the shortness of their barrels they are specially useful for railway mountings. Even in 1914 the Germans used howitzers firing huge shells up to 17 inches in diameter against the Belgian fortresses. A French howitzer, and by no means their largest or latest, throws a shell of 14.6-inch diameter weighing 1,000 lb. a distance of 7 miles. The weapon is hauled along on a double-girder truck driven by petrol engines. Guns and howitzers in fixed positions in fortresses can, of course, be very much larger.

The type of shell used by artillery includes High Explosive (H.E.),

'carrier', and shrapnel. H.E. shell is fired by all types of artillery, and when the shell hits the ground (or a little time after in the case of delay-action fuse), the explosive in the shell breaks it up into a large number of pieces. Carrier shell may contain smoke, incendiary, or other material. In the shrapnel-shell a time-fuse bursts the shell in the air and a rain of shrapnel bullets descends on the troops below. It is effective against troops in the open, but it is not easy to burst the shell at exactly the right place and time, and shrapnel is much less used in the present war than in the war of 1914-18.

Any description of anti-aircraft artillery would require an article in itself. Remarkable machines called *predictors* are now available which, in conjunction with height-finders, automatically train and elevate the gun in the right direction to hit a moving target. Anti-aircraft guns are constantly increasing in power and range. In the U.S.A. a 5-inch anti-aircraft gun is in use capable of hitting an aeroplane flying at a height of nearly 40,000 feet. Anti-aircraft guns of course require searchlights to illuminate the target at night, and star-shells can also be used for the same purpose.

The Corps of Royal Engineers has a wide range of duties calling for very special training, so that it is not usually possible to get into R.E. Militia units without previous engineering qualifications. Sappers are trained and equipped to apply engineering science and skill to the needs of the Army. Their duties include bridging, demolition, the making of anti-tank obstacles, the preparation of buildings for defence, military mining, construction and improvement of roads and railways, the development of water supplies and survey work. Special engineer units exist in rear areas for the construction

of buildings, the organization of workshops, the operation of inland waterways, and the maintenance and running of docks. It can be appreciated that such varied work involves a wide range of training, so that tradesmen and specialists are required in large numbers to cope with the problems involved.

The Royal Corps of Signals

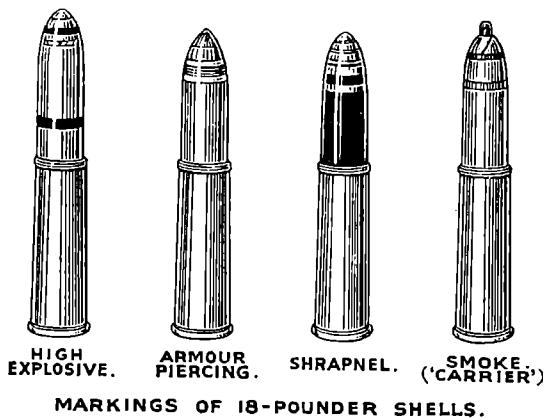

is charged with the supply and maintenance of all army communications other than postal. The latter comes under a special branch of the R.E. as far as the Army is concerned. Telegraphy and telephony, by line or wireless, is the main preoccupation of Royal Signals, and their training therefore takes a special electrical trend; but other means of communication such as visual (lamp, shutter, or heliograph) are also employed and motor dispatch-riders are widely used. When warfare is not too mobile carrier-pigeons and even messenger-dogs are sometimes employed.

The Royal Army Service Corps has two main duties: Supply and Transport. It is concerned with the provision of the Army's food, the baking of its bread, the supply of petrol. It is the Army's universal provider, and as all armies fight on their stomachs, its importance is fundamental. It also deals with transport arrangements other than railways, and provides the repair facilities except in cases involving serious breakdown or treatment at the base. Mechanical transport is so important in the modern army that this branch of R.A.S.C. activity has largely increased in recent years.

The Royal Army Ordnance Corps is concerned with the supply of weapons, clothing, and other equipment; it also runs the large base workshops where heavy repairs are undertaken and light-aid repair detachments. Mechanical engineers are much required here, as most of the heavy engineering work of the Army is undertaken by the R.A.O.C.

The above résumé of the work of the Army's various branches has necessarily been both brief and incomplete, but it is a difficult young man who cannot find with all this choice a branch to suit his special fancy.

In time of war recreational facilities have to be much curtailed, and emphasis must be laid upon getting the necessary training carried out in the shortest possible time. It is an essential paradox at such critical times as this that some loss of personal liberty must be undergone in order to protect the individual liberty that is the Englishman's birthright. The discipline that is necessary in every branch of the Army is strict but it is not unreasonable, and the young Militiaman will find that the training gives him qualities of self-respect and self-reliance such as he never had before. No one outside the Nazi ranks pretends that war is other than beastly, but it is infinitely better than the slavery of the Swastika. It is from the work of its young men in all three Services that the country looks forward to a time when we may be free of hate, free of bad faith, free of war, free of injustice, and by their aid we shall build a Britain that is better and finer than ever before.



SOMETHING NEW

IF you want to catch a gnu,
All that you have got to do
Is, from your stand behind some trees
Just pepper him and make him sneeze;
Helpless he'll stand with streaming eyes
And you can take him by surprise.

R. B. v. W.

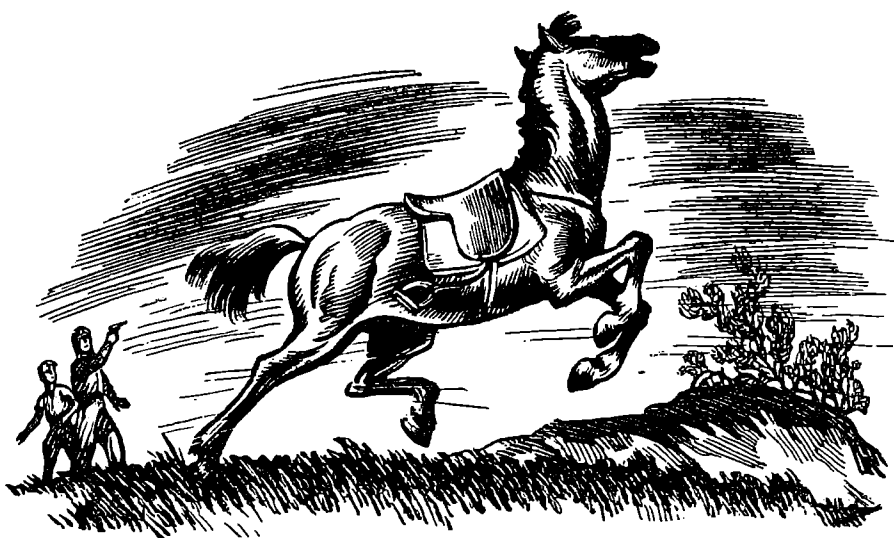

A SHOT IN THE AIR

By Air-Commodore L. E. O. Charlton, C.B., C.M.G., D.S.O.

I

IT was the first winter of the war, and David Milburn, rising seventeen and sturdy for his years, was spending the Christmas holidays with his aunt and uncle, the Dallases of Dally Castle, in Northumberland. For the last few years, ever since his parents had been out East, he had done the same and it was a practice altogether to his liking. In the first place, they were kindness itself to the grass-orphan, as he was playfully denoted, and gave him the run of their commodious and historic castle, with its battlemented leads, its ancient keep, and its workings underground from which the garrison, in days long past, would sally forth to fight. Standing by the roof flag-staff and looking up the valley of the Chirdon, the long-used pathway of the Scottish enemy from across the Border, David would sometimes give his imagination rein, picturing himself as Warden of the March and peopling the heather slopes with blue-bonneted clansmen intent on pillage. But not even the present war, he reflected sadly, could stir up events in such a peaceful landscape, for Nazi bombers were hardly likely to pay attention to a district in which the only things to bomb were sheep.

In the second place, and in spite of being town-bred, he loved the country-side in that part of the world, and, especially, the huge acreage of moorland, of which the Dallas property in the main consisted, with its

population of shepherds and hill-farmers. One could go for miles without either sight or sound of a fellow human being, and at dusk one had a feeling that the star immediately overhead was the only companion. In his time he had roamed the fells on foot and horseback in all directions, coming to know by instinct where the ground was treacherous and boggy, where the foothold was secure, and if a far-off crag were scaleable or not. David was alone in his glory, for his cousins were grown up and had left the parent roost. He was accustomed to his seeming solitude and as happy as a king.

On this particular morning he was waiting for the breakfast gong and wondering how he could best occupy himself on such a sparkling day. The local paper reported enemy reconnaissance flights over the Firth of Forth and Scapa Flow, beaten back as usual by the R.A.F., but otherwise, it seemed, the war had gone to sleep. His uncle's voice disturbed his reverie.

'Morning, Dave. Let's go in. Told them not to sound the gong. Your aunt's got one of her sick headaches. Got a job for you to-day if you're feeling energetic. Nice day for it too.'

David returned his uncle's greeting in due form, but knew better than to enter into conversation until the coffee had been poured and the meal had well begun.

'What can I do for you, Uncle Harry?' he then asked, these preliminaries being settled.

'Bah! What a war!' was his uncle's irrelevant reply as he flung the propped-up paper on the floor and bent over his plate of sausages. 'What's that? What can you do for me?' he continued with his mouth full. 'Why, you can take a layer of fat off Jennie for one thing, and you can give a message to old Tom Dodd of Paddaburn for another, and you can combine the two.'

These words rang pleasantly in David's ears. It meant a moorland ride of twelve miles out on his uncle's lively cob across a waste of heather almost entirely uninhabited except for black-faced sheep. It was just the day for such a jaunt, and he eagerly professed himself as more than delighted to be of service.

'I'll get off straight after breakfast,' he beamingly declared. 'Is it a written message or a verbal one? And can I take my small-bore rifle that I had for Christmas? I might get a pot at one of the deer that've been ruining your saplings in the new plantation. The agent says he thinks they harbour somewhere out by Sightly, and I shall have to pass it within a mile.'

'One thing at a time, one thing at a time,' his uncle said protestingly, quite unaware that he himself constantly offended in that respect. 'It's a verbal message. Tell the old man that his son is doing well in hospital and that the bullet went clean through. Nothing to worry about. Say I had it from the Chief Medical Officer out there after getting an inquiry through. They'll fall on your neck when you give them the news. And about the rifle. Take it by all means. If you come home with the carcass of one of those damn deer on your saddle I'll fall on your neck too. Now be off, and don't let Jennie put her foot in a hole. Take sandwiches and a flask. You'll miss lunch.'

David first paid a short visit of condolence to his aunt, who was not altogether in favour of the trip.

'Supposing a German airman parachutes on top of you,' she suggested in all good faith, 'where would you be then? I see it in the papers that they may be going to invade us that way. Oh! your rifle!' as David insisted that he would not be unarmed. 'What's the good of that against machine-guns and mustard gas and liquid fire and all the other inventions of the devil that they use. Well, get along with you. I see you won't take me seriously: just like a boy.'

He kissed his aunt affectionately and proceeded to the stable, highly amused at her conception of invasion from the air, and puzzled also, as always, at the combination she presented of quite ridiculous fancy and of good hard common sense.

'Jennie's full of oats, Mr. David,' announced his old friend Sam, the groom, who in earlier days had driven the family in state to church behind a stepping pair. 'If you have to tie her up mind you do it proper like. Specially if you're going near Sightly.'

This was a sly allusion to a regrettable incident on a former holiday. David had heard that on a fine clear day ten counties could be seen from the top of Sightly Crag, and he had been anxious to put it to the test. Jennie had just come up from grass at the time with a pot-belly and no great zest for moorland rides. But they had got there in perfect weather, and when the noble panorama burst on David's sight he had excitedly dismounted, hurriedly tethered Jennie to a stunted alder bush, and then drunk in the beauty of the scene in rapt amaze. A movement and the clink of iron on stone brought him to himself. It was Jennie making an escape, and he watched her with his glasses as she grew smaller with the

distance, heading straight for Dally, the comfort of a stall, and the corn-bin which she had been sighing for when out at grass.

'You needn't worry, Sam, I've had my lesson,' he said with frank acknowledgement, and then, bidding the groom be ready in fifteen minutes, hurried off to change, collect his lunch, and sling on his miniature rifle.

II

Travelling up the stony valley road, little more than a cart track in most places, while crossing and recrossing the peaty Chirdon water at the fords, he turned off left at Allery Bank and gained the high ground overlooking the little hill-farm of Cairnglasshope. From this eminence the moor stretched away unendingly before him in bold sweeps of ridge and low ground intervening, with here and there the dark line of a crag on top like the ruins of a vast system of fortification. At the limit of his vision the sun glinted on the River Irthing and lit up a homestead on its near bank which he recognized as Paddaburn, the objective of his journey. Old Sightly towered to the right, and he noticed with mild surprise that its summit was not distinct according to the promise of the day. The little wind there was had also changed and now blew from the west, pushing, as it were, ahead of it, not clouds, but rather a general greying of the sky.

David was weatherwise by dint of much experience and foresaw that the brightness of the day would soon be gone. He recognized the possibility of fog and trusted for his own sake that enough visibility would remain for him to see his way. Sometimes these mists did not descend to earth but hovered overhead a hundred feet or so, and he sincerely hoped that such would prove to be the case on this occasion. Gloominess would be all around, but a man could pick his way, and in this hopeful frame of mind he proceeded. By the time he reached the deserted shiel on Hopehouse moor the sky ahead had become completely overcast, and at the rate the rack was travelling the remainder of the blue would soon be blotted out.

Continuing to make good progress, for he was as good a fellsman as any Northumbrian born and bred, he was within a mile of Paddaburn when, very faintly, the murmurous noise of distant aircraft fell on his ear from above. That there were several of them was evidenced by the rhythmic interference to be heard amid the droning sound, as of an attempt at jazz-time in the sky, and as he listened further his ear detected a popping noise which was unmistakably the rapid fire of machine-guns far off in the air.

Feverishly unslinging his binoculars he searched the sky and, for one moment, glimpsed the dark shapes of aircraft high up in the direction of Dally. But while he looked the mist obscured the sky and blotted out his vision. Highly excited at this momentary peep at battle in the air he pursued his way, confident that the R.A.F. had got the best of it as usual and eager to listen in to the B.B.C. News Bulletin as soon as he returned. Fancy them coming in as far as this, he said in his mind. What cheek, and how they must be regretting it by now! But even as the thought framed itself an event occurred in his more immediate neighbourhood that brought him back with a thump to things terrestrial.

This was the spectacle, a quarter of a mile away, of one of the hated deer, facing up wind and apparently quite unconscious of the presence of man, or boy, armed with a sporting rifle and out for blood. David at once dismounted and led Jennie with infinite care behind a large boulder near to which a hawthorn bush, windblown and distorted in shape, was growing. Looping the reins over a stumpy branch that pointed upwards, and satisfying himself experimentally that the fastening was secure, he unslung his rifle and began to stalk. Every condition was favourable to success. The wind was light and in the right direction, the greyness of the mist, now lying in a layer overhead and about a hundred feet up, afforded sufficient visibility and yet assisted to disguise his movement of approach, and the ground so lay that he had cover for a great part of the way. With all the zest of a sporting appetite he addressed himself to the task in hand. But his stalk was never completed.

The first thing that happened was in itself peculiar, because a deer when undisturbed does not usually career wildly straight towards the stalker in a downwind direction. Yet this one did, for when David cautiously raised his head to locate the quarry it was coming at him full-bent, and almost overran him in excess of terror. He raised his rifle, but realized the hopelessness of hitting such a moving target and lowered it again. As he did so he heard a sound, hitherto muffled by the mist, which was more than sufficient to account for the panic of the deer. It was again the noise of aircraft, but this time immeasurably more significant, for it became louder as he listened and his instinct told him that it proceeded on this occasion from a solitary machine. It was out of sight and yet close to, with an almost deafening roar at times, and then the sound was deadened for a while, only to pick up again.

The natural conclusion was that a R.A.F. aircraft, perhaps one of those that had been lately fighting overhead, had been overtaken by the fog and was wandering about low down in an attempt to find its way back home. Such was David's thought, and he heartily commiserated with the pilot, hoping with all his might that it would not come to grief. What, therefore, was his surprise and consternation when a large black shape loomed from the mist, flying straight at him and, as it then seemed, only just above his head. He ducked, but not before the thing, from being a friendly aircraft in distress, suddenly assumed the nature of something hostile and malignant. For the Swastika was on the under-surface of its wings, most plainly to be seen, and the same hideous device was painted on the tail-fin.

David could never afterwards retrace the process of his thought, nor of his action following. The latter, he avows, was quite involuntary. Probably what he did was really a gesture, a sort of 'take that!' as one might hurl a useless pebble at a chicken-thieving hawk. The only thing is that what he did was very far from useless, being attended with consequences which were altogether unforeseen. He threw his rifle to his shoulder and pulled the trigger absolutely at haphazard. Now cases have been known where aircraft have been brought down by machine-gun fire from the ground. Richthofen, for instance, met his fate in that way. But that a single small-bore rifle bullet should have done the same was one chance in ten million, to put it at the shortest odds. And yet that is just what happened. The monster appeared to stumble in mid-air, if such can be imagined, and before it could recover from the peck, so low it flew, it topped the heather and somersaulted with a rending crash.

David stood aghast at what he had accomplished, neither elated nor dejected, but just dumbfounded. Even then it never passed his mind that an ordeal might lie ahead, and it was not until three bruised and battered airmen came scrambling from the wreck that he began to wish himself elsewhere. One was limping badly, another had a nasty face-cut, but the third, who appeared to be the leader, seemed to be miraculously whole. It was this last who started the proceedings, advancing on the cause of his discomfiture revolver in hand.

'So,' he said in quite good English, 'it was you who did it, yes? You do not belong to the armed forces of your country. You are a civilian in arms. That is death! Do not move or I will shoot you before you take one step.'

This admonition was quite unnecessary, for David was rooted to the



'Your name?' he asked, and David gave it

ground. He began a halting explanation but was curtly ordered to be silent. The other two by now were attending to their injuries, which, from the fact that they conversed together in animated style, were obviously not serious. To them the leader strode, and a short conference ensued, after which he turned again to David.

'Your name?' he asked, and David gave it.

'Where do you live?' was the next question, and 'Nine miles in that direction,' David answered, pointing towards Dally.

'How did you come?'

'I rode.'

'What on?'

'My horse is over there,' and David indicated the hawthorn bush, the top of which, about two hundred yards away, could just be seen.

'Show me!' and he waved David ahead with the muzzle of his pistol.

David preceded him with great misgiving. He had little expectation that his life would be spared, but he shuddered at the thought of being shot from behind. But his dire predicament was momentarily driven from his mind when he saw what was happening at the hawthorn bush. Jennie was struggling furiously to get free, tugging at her bridle with all the appearance of mad terror. She must have been at it for some time, for her

neck and flanks were white with the foam of perspiration. When he and his captor were about half-way, her head-strap broke and she at once made off at a gallop, bridleless. Then came a moment of horror, during which he forgot himself entirely. For the German pointed his revolver and let fly at poor Jennie until all six chambers had been emptied. The first two shots missed clean, but the third must have scored a hit because Jennie swerved and faltered in her stride, and, although she galloped on, it was plain that she did not run so free.

'You brute!' cried David while the three remaining shots were being uselessly discharged, quite forgetting that he himself was at the mercy of this butcher. 'You coward to shoot at Jennie!'

This abuse, instead of firing the German's anger, appeared to have an opposite effect. He looked down at David with a smile and actually patted him on the back.

'You have courage,' he said, 'to call me names when you are in my power. I had to shoot when your horse got free. I know what horses do when they are free and frightened. They make straight for their stable, and this one was doing that. I do not want searchers looking for you and finding us. Until I and my comrades are taken prisoner we have a chance to escape. I am sorry. She is wounded now and will not go far. Perhaps you may even ride her again some day.'

'Then I'm not going to be shot?' said David, taking him up with promptitude on his last remark.

'Not if you are good and answer all my questions. You have done big mischief, but it was an accident of war. I was flying carelessly and when your bullet hit the control and took it out of my hand I was too close to the ground for recovery. We were lost, but in time we would have found the coast and flown back home.'

While talking they had approached the two wounded members of the crew, and another consultation was held in their own language. After several 'Ja's from all three, as if an agreement had been reached, the leader turned again to David and resumed his questioning.

'Where is the nearest dwelling?'

'Paddaburn, a small sheep-farm. You can't see it for the mist. It's about a mile in that direction,' and David pointed his hand.

'Who live there?'

'The farmer and his wife, an old couple.'

'No one else?'

'Not that I know of.'

'Has he a horse and cart?'

'He's sure to.'

'And the nearest town of any size away from where you come from?'

'Greenhead on the Roman Wall and railway, about seven miles.'

'Goot!' said the German with high satisfaction, and, except that his s's had sounded a little like z's, it was the first time that his speech gave away his origin.

First the face injury was bandaged, and then, with David supporting one side of the man whose leg was injured, and the leader bearing him up on the other, the slow procession made its way across the heather. The mist had now descended to the ground, but a foot-track served to guide their steps, and an hour later the leader burst open the farmhouse door, revolver in hand, and strode across its threshold.

The Dodds were at their midday meal and started to their feet in great alarm, bewildered also to see the Squire's nephew in such company.

'Tell this man and woman who we are and what we want,' David was commanded, and forthwith he gave a brief account of what had taken place, adding that it would be useless to resist and that it would be necessary to put the horse in the cart. 'Oh, and Mr. Dodd,' he concluded with surprising coolness, 'I've a message for you both from my uncle. It's good news. Michael is safe and well in a base hospital and only slightly wounded.'

The old couple received this news with unfeigned gladness, and tears began to trickle down Mrs. Dodd's face. The German leader looked down at her with sympathetic interest.

'So even this house, so far away from everything, has been touched by the war,' he remarked in a kindly tone of voice, and then, resuming his attitude of command, began to order them about.

'You,' indicating the farmer, 'go and put your horse to quickly. And you,' addressing his wife, 'go upstairs and bring down all your husband's outer clothing that there is. We will eat your meal instead of you and thank you for your hospitality. Be off now and lose no time.'

Both Dodds began a sharp protest which was cut short, in the case of the man, by a threat to burn the building if there was any hesitation to obey, while David himself advised submission.

'There is nothing else for it,' he declared. 'They have the whip-hand

and are avoiding capture. They'd go to any lengths. This one,' pointing out the leader, 'has already shot poor Jennie.'

'You show good sense, my young friend,' the German said. 'I would prefer to do no harm. But my country is at war with yours, and we Germans do not fight in gloves.'

In about ten minutes the Germans were ready for departure. The cart was ready, with a tarpaulin beneath which the bandaged man might hide and not provoke inquiry. All three were arrayed in Mr. Dodd's mixed clothing which, though baggy in some places and tight in others, did not fit so badly on the whole. The leader had put on the farmer's Sunday suit of black, with a shovel hat to match, and looked not unlike a Dissenting Minister. Then came a bad moment.

'And now some rope,' he said. 'You must be tied up securely so that you cannot give the alarm for many hours. I am sorry, but it is absolutely necessary.'

This was a horrifying proposition in that out-of-the-way part, and the Dodds and David looked at each other with consternation. It was the latter who first found his voice.

'But you can't do that,' he cried. 'The nearest house is five miles off and it might be days before we were released. It would mean death by slow starvation and would be murder.'

'Perhaps then you have an alternative suggestion,' replied the leader sarcastically. 'I am only concerned with the safety of myself and my two comrades.'

'Yes I have!' David vigorously declared. 'It is this. I will pass my word of honour that none of us will move away from the place for, say, eight hours. By that time you will either be prisoners or still free. You've heard of an Englishman's word of honour? It is absolutely binding.'

The leader regarded him attentively, as if weighing well the proposal. 'Yes,' he said, half in meditation. 'I know about your word of honour. I was at school in England. If you gave it I believe you would be fool enough to keep it; you are the strangest people. Very well. If you swear on oath not to go outside this house for twenty-four hours, and to make no signal of any kind, I will not bind you. But can you answer for the two old people?'

David said he could, and gave his promise, whereupon, after inquiring further details of the road, the two injured men were helped aboard and the heavy cart moved off with the leader driving.

III

For a little time Mrs. Dodd sat weeping, while her husband swore strange oaths into his beard and David walked up and down the kitchen in heavy thought. The fog began to lift. More food was cooked and they ate with fair appetite. David recounted the whole history of the incident in detail. A thanksgiving prayer was offered up for the safety of Michael Dodd. They discussed the Germans' chances of evading capture, agreeing that if they succeeded in reaching the railway they might well get right away. Three miles from Paddaburn the farm-track merged into a made road along which they could jog and make good time. They would probably leave the horse and cart just short of Greenhead, and go into the town on foot. It happened to be market-day, and three strangers could easily escape observation among the busy crowd. Thus did they talk the matter over as the time slowly passed until two hours had gone.

'The blighters'll be at Greenhead by now,' said David, looking gloomily out of the window, and the next minute electrified the old couple by excitedly exclaiming, 'Great snakes! Quick, come and look out! Is that your cart coming back, or isn't it?'

Mr. Dodd only needed one glance to recognize his own possessions. His cart it surely was, and his sharp eyes, trained to descrying objects at a distance, noted something else as well. A different man was driving, and the body of the cart contained several others who were standing in full view.

'They're soldiers,' he exclaimed. 'Now may the Lord be praised, they've caught them rascals.'

It was true. They ran out to meet those who were approaching, and Mr. Dodd quickly recognized among them a sergeant of Territorials of his acquaintance.

'Where be them danged Germans?' he shouted lustily as soon as he was near enough to be heard.

'Safe in jail,' came back the answer, and a few minutes later the story was being told.

It appeared that a message had been 'phoned through from Dally Castle right away in an opposite direction, saying that David's horse had come in riderless with a bullet wound and almost at the last gasp. A search party had been requested from Greenhead as it was feared that its rider might be lying seriously injured. Just as the party was setting out another message was received to the effect that there were peculiar and suspicious

circumstances about the affair, and that it might be advisable for some of the search party to be armed.

'We asked for further details,' explained the sergeant, 'and then Sir Henry Dallas came on the 'phone himself. He said that the bullet wound in his horse's flank had been made by a weapon of larger calibre than the miniature rifle that his nephew had with him, and it was possible there was mischief afoot. But neither Sir Henry nor any of us put it down to Germans. There was a jail-break at Carlisle a day or two ago, and we thought perhaps the two escaped convicts had got hold of fire-arms, and were making across country for Newcastle.'

'Then how did you cotton on to who was in the cart?' asked David eagerly.

'Oh, that was easy,' said the sergeant. 'We were in two cars, and had just reached the road end when we saw the cart approaching. Now a farm-cart with a man in front driving is a very usual sight hereabouts, but there were two or three funny things about this one. The horse was all of a lather and fair dropping for one thing, and no farmer worth the name drives like that. The cart was mucky for another, with muddy wheels and manure straw sticking to the sides. That again is not unusual, but when the driver is wearing Sunday black and sitting on a mucky cart, then it makes one think. So we stopped him, asked him what he had on board and took a look. After that, of course, the game was up, and the three of them are now in the Greenhead lock-up waiting for an escort. They told us what had happened, and how by the unluckiest of chances they were brought down. There'll be a crowd out here soon to see the bomber, and I came on ahead with these lads to return your cart, but chiefly to go to the place and see that no one interferes with the bits and pieces. With live bombs you never can tell. Congratulations, sir, on a fine bit of shooting,' he concluded, turning to David. 'Some camera men'll be along in no time and we shall be seeing you on the front page of all the papers.'

There is one small detail to add. When David at last got back to Dally and had endlessly been questioned on his adventure, he finally asked his uncle a thing that had been for some time in his mind.

'How was it, Uncle Harry,' he said, 'that you jumped so quickly to the conclusion that Jennie had not been hit by my rifle?'

'Wasn't me at all,' his uncle answered. 'In a way it was your aunt's doing.'



We stopped him, asked him what he had on board and took a look

'Why, what on earth does Aunt Molly know about bullet-holes?' asked David, greatly puzzled.

'Ha-ha-ha, you'd never guess. Really, her headache did the trick, if you understand me. You see, she sent for the doctor, and old Purvis knows all about it. Ought to, considering he's been through three wars. He was here when Jennie draggled in, pretty nearly done. And of course he spotted it at once. And now let's go and see her. The vet. says she'll pull through with no harm done. She's done a good job of work and ought to have a V.C. Yes?' he asked impatiently as the butler came through the door.

'Beg pardon, sir, but there's a movie outfit at the door, and they want to see Master David.'

'Now you're for it, Dave,' his uncle said with vast amusement. 'Off you go, and ask them for a contribution for our local wool fund in return for taking your picture free, gratis, and for nothing.'

David went.



DUNGUDZA

The Roan Bull

By
WILFRID ROBERTSON

DUNGUDZA, the roan-antelope calf, crouched in the long grass, his feet doubled under him and his nose and ears alert for danger. Though the Rhodesian sun beat down fiercely and the air quivered with summer heat, he shivered from time to time, for he was both frightened and hungry.

For two days now he had been alone, since that evening when his mother had been struck down under the sudden rush of the fierce tawny beast that had sprung on her from the reeds. Scared by the terrifying scent of lion, Dungudza had fled as fast as his month-old legs could carry him. He had hidden and waited, but no mother came to seek him; instinctively he knew she would come no more, for something told him that scent of lion spelt death.

Abruptly Dungudza's body became tense. His ears had caught the sound of approaching steps—steps that did not sound like any animal he knew. Nearer they came; the line they were taking would bring them right upon him. He sprang up and broke into a staggering run, his immature legs weak from starvation.

John Harker, rifle in hand and followed by a native, instantly halted. With the instinct of a man who has lived long in the bush and is used to its dangers and surprises, his weapon was half raised before his eyes made out the cause of the sudden commotion in the grass and leaves.

'A roan calf!' Harker exclaimed. 'Looks as if it were lost. Catch it, Guba,' he added to the native behind him; 'be careful not to hurt it.'

With a grin Guba dropped his spears and gave chase. Dungudza had no chance of escape; grass stems hampered his weak legs and branches caught against his chest. There was a despairing bleat; and the next moment Guba's black arms were round him. With the fatalism so often noticeable in young wild things when the inevitable has come, he remained quiet in Guba's grasp, his eyes wide with terror and his heart throbbing madly.

Harker laid his hand on Dungudza's back, stroking it gently. 'Poor little brute! It probably belongs to that roan cow we found the eaten remains of,' he went on in the local language to Guba, 'done in by that lion that's been killing our cattle on the ranch recently. Carry it back to the house, Guba, and I'll feed it—otherwise it'll starve.'

Guba's eyes widened in surprise. Truly the ideas of white men were beyond understanding. If the beast's mother had been killed, had not fate ordained that the calf should starve to death? Such was the philosophy of his tribe; but he knew it was useless to argue. With a mental shrug at the well-known madness of white people, he lifted Dungudza on to his shoulder, grasped the legs on either side, and prepared to face a long and laden tramp in his master's wake.

That night, instead of the bush, Dungudza was surrounded by the walls of a small pen at the back of Harker's house. No longer was he hungry, for despite his struggles at the touch of human hands, he had been compelled to swallow a quantity of rich, warm milk. But though the pangs of starvation no longer gnawed at him, his mind kept him awake; and continually during the night he moved on shaky legs round and round the pen, calling at intervals for the mother he would never see again.

As the days passed, however, Dungudza rapidly forgot her, and became reconciled to his new surroundings. Harker and the black cook-boy took her place; instead of resisting, he looked forward eagerly to the appearance of the galvanized bucket that contained his meals. Presently he was released from the pen, entering it only at night to sleep, and his days he spent wandering around the ranch-house. Harker's vegetable garden, where he strove to raise a few cauliflowers and lettuces, was a special attraction, and more than once Dungudza had to be disentangled from the wire fence with which the white man had surrounded that forbidden Eden.

As the months passed Dungudza grew in size and strength, and his wanderings led him farther afield. He joined himself to the cattle in their grazing, living and wandering with them about the ranch; and at night he slept with them in their kraal. He left calthood behind him and became a sturdy young bull; while his stout, annulated horns lengthened and curved towards the full shape of maturity.

Dungudza was contented up to a point; he had food in plenty and life was free from dangers and alarms under the protection of man. Yet as he grew to maturity he was conscious of a strange urge in his blood, a desire he could not define but which left him restless and dissatisfied. It was the call of nature and the wild life of his ancestors, and the urge to seek a mate among his own kind.

One night, as usual, Dungudza was lying in the kraal among the sleeping cattle. Suddenly he jerked up his head, his nostrils sniffing suspiciously. Slowly he turned his head from side to side, the faint moonlight outlining his long, tasselled ears and stout, curved horns.

The whiff of scent came again, brought to him by the faint night breeze. He recognized it and it struck an inexplicable terror into his heart; for it was the same long-forgotten smell as that of the beast that had slain his mother.

He started to his feet. As he did so a tawny shadow surmounted the fence and sprang on to the back of an ox.

Instantly every beast in the kraal was up, rushing madly round and bellowing with alarm. Wildly the cattle stampeded away from the spot where lay the killer and its victim.

Crash! The poles of the stout stockade gave way under the pressure of frightened bodies. Through the gap poured the herd, dust rising in clouds under the pounding of terrified hoofs.

Dungudza followed, seized also with panic; with one bound he was through the gap and over the prostrate poles, flying from the ill-fated spot. In and out of the trees he sped, stretching his muscles to the utmost. Small buck and other unseen creatures slipped away before his onrush; and far behind him he heard the shouting voice of Harker, the calls of awakened natives, and the report of a rifle that cut the darkness like a whiplash.

Dungudza did not slacken his pace. The scattered cattle had halted and he was now alone in the silent bush; but steadily he drove onwards. Fright had gone and only exhilaration remained. That urge which had

bothered him for weeks was fading as mile after mile reeled away under his flying hoofs.

When the pearly grey of dawn tinged the eastern sky, Dungudza's pace had dropped to a slow trot. Onward he moved, still seeking he knew not what, but confident that he was soon to find it. Rapidly the sky brightened and the sun came up, bathing the bush with golden light. Dewdrops sparkled everywhere, and at each step Dungudza scattered them like falling diamonds from the stems of the grass. His nostrils sniffed the freshness of the African dawn, and he tossed his head with the thrill of awakening life.

Presently he descended into a valley, and paused to drink from the little stream that wandered along the bottom. He had run many miles, and thirst was beginning to make itself felt. Having drunk his fill, he spent some minutes eating the green shoots that grew thickly round the water. Refreshed, he slowly climbed the opposite bank, and as he topped the brow he caught sight of something moving among the trees.

The young roan cow caught sight of him at the same instant, and for a few seconds they stared at one another. Then with a flick of her long, tufted tail she broke into a canter.

Instantly Dungudza's fatigue was forgotten; he had first found the freedom for which he had uncomprehendingly yearned, and now he had found a mate of his own kind. He struck out in pursuit. Before another hour had passed the two were walking side by side through the shadowed aisles of the forest.

Dungudza had no training, such as he would have gained from his mother, to help him in the eternal fight of the wild for existence; but the instinct of generations stood him in good stead. Much also he learned from his mate; how she either bolted or took no notice of scents that puzzled him, how she avoided certain localities and certain types of grazing, and how she found sleeping-places giving easy escape in case of alarm. Ever on the alert for danger, they lived unscathed in a country full of possible enemies.

Usually they evaded danger, but there came a day when Dungudza found himself up against it. Perhaps immunity had made them careless; and had not Dungudza been exceptionally strong and active, his career would have ended there and then.

The two had been lying in the shade of a mahogany tree, resting

during the midday heat. It was a slight shift of the light breeze which saved them, a little eddying puff that brought its message of scent.

With movements incredibly swift for animals so large, both were on their feet. The lion, with a growl of chagrin, checked its cautious advance through the grass. It was an old beast—hence its daylight attack, for it was desperately hungry, which made it break the feline custom of hunting only at night.

It had lost the advantage of surprise; but the lost ground might be regained. With a bound it sprang forward, counting on Dungudza and his mate turning to flee and offering their undefended sterns to his second leap.

The roan cow fled instantly, but Dungudza stood his ground. He had seen instantly that the range was too close, and that to turn meant death. Instead he jumped forward with a snort, his horns lowered; the lion flinched away, and Dungudza's mate escaped untouched.

Immediately Dungudza backed till his stern was against the trunk of the mahogany tree. With his defenceless rear protected by the bole, he faced the enemy with lowered horns.

The lion began to circle round, growling. Dungudza moved also, keeping his stern against the friendly trunk and his head facing the point of danger.

There was both rage and fear in Dungudza's heart; the lion scent terrified him, yet he knew that to bolt was death. If once the lion could get to close quarters and under his guard it would be all over with him. Pawing the ground and snorting, he kept his face to the enemy.

The lion crouched, every muscle tense. Then with a roar it made a spring straight towards him.

It was only a feint to make him turn, and Dungudza called his bluff. Bracing himself, he stood firm, his horns ready. With a snarl the lion twisted aside. Both fighters resumed their former places, like boxers at the end of a round.

The lion tried other tactics, trying to draw Dungudza out to attack him; but the roan was not to be taken in so easily. Round and round the tree they circled, till the grass and undergrowth was beaten down, and dust rose at every movement.

Fear began to chill Dungudza's heart. He was tiring from the constant movement and watchfulness, and he knew that if he gave one opening to the enemy, those terrible teeth and claws would tear his life from him.



His horns drove home in something soft and yielding

The lion saw his opponent weakening, and redoubled its efforts. At last it saw a chance—with a sudden rush it sprang.

The trampled and dusty ground betrayed it: as it leaped one foot slipped, and the bound fell a few inches short.

Dungudza swung round his head in desperate rage, and his horns drove home in something soft and yielding. The gleaming teeth and hot breath were right in his face. There was a snarling roar of pain, a rip across the withers from an armed paw, and the lion was on its back, blood spurting from its wounds. Twice it tried to get to its feet, but Dungudza did not wait to see if it succeeded; with one bound he was among the trees, while the lion's head dropped with a groan on to the trampled earth. A mile away Dungudza found his mate awaiting him; and together they travelled onwards, unharmed save for the sting of the lion's claws where they had ripped Dungudza's skin.

Some days later Dungudza noticed a strange restlessness in his mate; she seemed to be seeking something, and resenting his presence when he followed her. And one morning he found himself alone.

For three days he searched the bush for her, and on the fourth morning

he saw her coming towards him through the trees. But she was no longer alone; on shaky legs beside her moved a new-born calf.

Dungudza sniffed his son suspiciously, while his mate kept a watchful eye on him lest he should harm the new arrival. The creature puzzled him, and he could not make it all out; but anyway it seemed to belong to them, for its smell was the same as their own. Nonchalantly he accepted the presence of Dungudza the Second; and the trio once more dropped into their old routine.

Not far from where they lived, and in the direction of John Harker's ranch, were several native villages. Heavy grazing always improves the quality of grass, and there were several choice bits of feeding-ground near the villages where the cropping of the native cattle had sweetened the herbage. Dungudza had discovered the fact and appreciated it; but always he had the greatest difficulty in persuading his mate to accompany him on his visits to those parts.

Dungudza could not understand her attitude. Having been handled so much by natives as a calf, their proximity did not alarm him. That there might be some reason for her trepidation, however, was brought home to him one day when he was approaching a certain grazing-ground in the cool of the evening.

Dungudza was leading, his mate and the youngster following behind with lagging steps.

They were moving through the aisles of the forest, following an overgrown game-path they had not previously taken. Everything seemed safe and quiet in the dusk of the bush, and Dungudza had no thought of danger. Thrusting his way through the foliage, he did not see the suspended noose, and a moment later it had drawn tight round his head.

It was lucky for him he was moving slowly, or the jerk would have broken his neck; lucky also that the noose held him by the head and horns instead of round the throat.

Instinctively he jumped backwards; but instead of releasing him the cord only tightened its grip. In panic he turned to escape; the noose and rope came with him, for its end was attached to a heavy log that his efforts dragged along the ground. Had the rope been firmly fixed his strength would have broken it; the movable log was a device especially to prevent such a happening, and to leave a trail through the bush so that the setter of the trap could follow up in the morning.

Dungudza's mate, wide-eyed with anxiety and alarm, ran distractedly up and down, while the scared calf clung close to her heels. She had warned him as best she could; now the worst had happened and she was powerless to help.

Desperately Dungudza struggled, dragging the log this way and that, while the grip on his head half throttled him. He was rapidly becoming exhausted.

Steps, human steps, became audible, and the sound of human voices. The anxious watcher and her offspring moved into cover, where they could see without being seen. To Dungudza's mate this was the end; the worst had happened.

From the cover of the trees Harker emerged, followed by a couple of natives. He was on a short tour of exploration beyond the borders of his ranch; hearing the sound of thrashing and trampling among the leaves, he had turned aside to investigate.

'Hullo! A roan bull in a trap!' With a motion of his hand he restrained his followers, who, native-like, were about to rush forward to spear the helpless victim.

At the sound of the voice Dungudza ceased to struggle. Often in the days of his youth he had been caught by the wire fence round Harker's garden, and Harker's coming had always freed him from the clinging strands.

The white man started in surprise at the sudden quiescence, so contrary to the habits of a creature of the wild, and then he comprehended.

'It must be Dungudza!' he exclaimed. 'Dungudza, is it you?'

Dungudza snorted in friendly greeting and bent his head towards Harker's releasing hands.

'Well, I'm blowed!' Harker exclaimed, as he cleared the noose. With a quick movement he slipped the end of the rope round the bull's neck, as he used to do in the old days to lead him back to his usual quarters. 'You'd better come along with me; you're safer on the ranch, old chap.'

Dungudza knew the dominating will-power of men, and the uselessness of resistance. Reluctantly he allowed himself to be led away; while like a silent shadow his mate and calf followed unseen in the wake of the party.

On the following morning Harker woke early and remembered his return to the ranch with Dungudza. He got up and strolled across to the little enclosure where he had penned his captive. Outside it, in the growing

light of the dawn, stood a roan cow and calf, while Dungudza's nose was thrust out to them through the poles.

Harker understood. With a shrug of his shoulders and a smile he approached, releasing the bars, while the two visitors watched him from a safe distance.

'You're free!' Harker murmured, as Dungudza emerged at a trot. 'I won't make you stay if you want to go back to them and to the bush.'

But Dungudza did not leave the ranch. Instead the trio remained, grazing in the vicinity of the cattle and never sleeping very far from the kraal at night. Wild, and at the same time tame, they remained on and around the property, a marvel to the natives and to Harker's infrequent white visitors; and Dungudza the Second grew to maturity on the same ground where Dungudza the First had spent his youth.



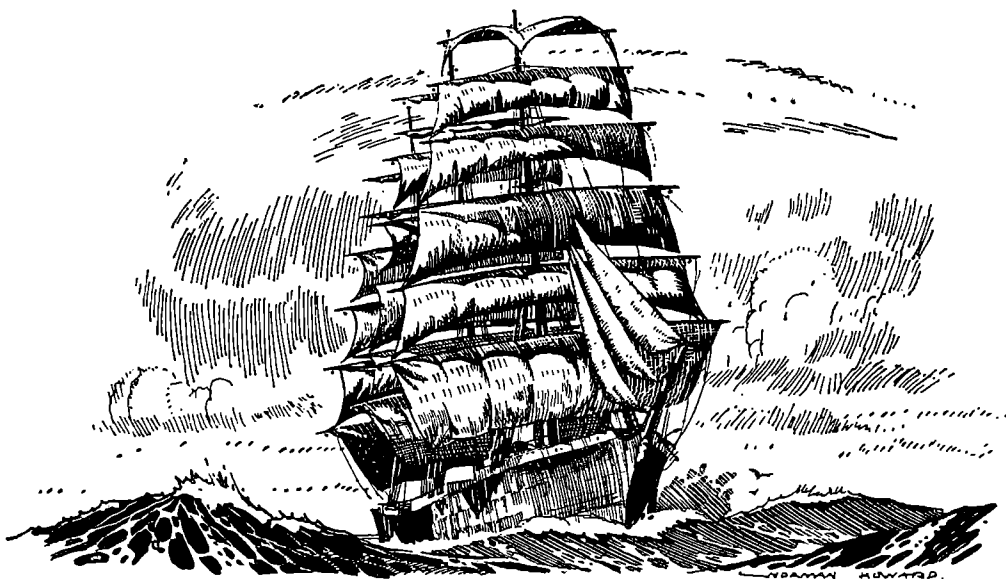

SEA-LION ISLAND

One of the Skipper's Yarns

By C. FOX SMITH

THERE'S no doubt at all of the fact that sea apprentices nowadays have a whale of a time compared with what we brassbounders had in the days of sail—except, of course, when there happens to be a war on. Better food, of course—no knocking the weevils out of the biscuits before you eat them, or making up to the 'doctor', as the sailing-ship cook was always called, for the privilege of cooking your 'dandyfunk' in the galley stove. Dandyfunk, I might explain, was a concoction made of biscuit beaten up small and mixed with molasses (when you could get it, which wasn't often), and, horrible mess though I suppose it really was, it tasted fine to a hungry boy with his belt-buckle rubbing against his backbone. Better accommodation, too—the half-deck in which we apprentices lived in the *Semiramis* was a gloomy little den with four bunks a-side, and if one of us grew too quick, well, he just had to double himself up a bit to fit his sleeping-place; the bunks weren't designed for six-footers.

Then, again, in these days, so far as time goes there is no such thing as a long voyage, unless, that is, you go on a Polar expedition or something of that sort. The modern seaman is never cut off altogether from the land

as we used to be for months on end, yes, and for years almost. Even in mid-ocean he is still in touch with the shore; he has his wireless, he can hear the news, even listen to a concert if he wants to.

Well, of course, that's all very nice, but, like everything else, it cuts both ways. People who have never known what it is to be absolutely out of sight of land for the best part of a year can never know, either, the glorious thrill it gives you when you at last set foot on shore again; what it is like to hear the birds singing when you've not heard them for months, unless it might be an occasional sea-bird, and see grass and green leaves and flowers. You can take it from me, it's a wonderful feeling!

And I daresay that was how it was that it seemed to go to our heads so when we got ashore. We just went mad, and I don't know that it was very surprising; and whatever port it was we were in, we invariably managed to get into some sort of scrape, big or little, before we had finished.

I remember one rare pickle we landed into at a little place called Mossel Bay in South Africa, so called because of all the 'mossels', or mussels, they find there. It's grown into quite an up-to-date port now, I believe, but in those days it was a nice quiet homely little spot, and you wouldn't have thought there was much mischief even for a sailing-ship apprentice to get into.

But our Old Man evidently didn't think so. At any rate, he kept a pretty tight hand on us, and hardly allowed us ashore at all, and then only if, as he thought, he knew exactly where we were going. And in the meantime we were kept pretty busy with a whole lot of odd jobs on board, cleaning out stringers after our cargo of coal, painting down, and what not, so that we hadn't too much time left to growl about our grievances.

One day we were slung over the side on stages, chipping paint, when the fellow who was working beside me, Purkis his name was, a second voyager like myself who had joined the ship from another of the firm's vessels in Frisco, started telling me some yarn or another he'd picked up from one of the hands about a Dutch East Indiaman that was supposed to have been wrecked on a small island we could see from the ship that went by the name of Sea-Lion Island. The ship, according to this story of Purkis's, was lost back in seventeen-something, with a whole lot of treasure on board, and now and again, if you were lucky, you could pick up quite a crop of big silver dollars on this Sea-Lion Island.

Silver dollars sounded good enough to me, as they would to any one who hardly saw the colour of money from one year's end to the next.

But, as I pointed out to Purkis, these particular ones might as well be in the moon for all the good they were likely to do us, seeing the Old Man wouldn't let us out of his sight for more than four hours at a stretch.

'Oh, that'll be all right,' said Purkis blithely. 'I'll manage it somehow, you see.'

'That'll be all right' was Purkis's great saying. In fact, it had got to be quite a joke among us.

'All right my elbow,' I said rather crossly. 'Don't be an ass!'

And the mate coming along at that moment and looking over the rail to see if we were getting on with the job, the matter dropped for the time, and so far as I was concerned I never thought of it again. Purkis was always picking up some wonderful yarn or piece of news from somewhere, and he believed anything and everything he was told.

It must have been two or three days later that we had leave to go ashore for the afternoon to have tea with some people, the shipping agent's family to be exact. Of course we were all very pleased about it when the Old Man told us, and Purkis seemed quite excited, for he kept winking and making faces at me behind the captain's back all the time he was talking, in a way I couldn't quite make out.

Well, we togged ourselves out in our best shoregoing rig, brassbound caps and all, and off we went.

There were five of us apprentices, Baines, the senior, Purkis, an Irish chap we called Paddy, myself, and the first voyager, Timmins. Baines was a big fellow, nearing eighteen, if not more, and he fancied himself very much as what used to be called in those days a Nut—that is to say, he put pomade on his hair, and spent all his money when he had any on silk socks and such rubbish as that. Moreover, he had started a love affair with one of the girls at the house where we were going to tea, so of course he was tremendously keen on this trip. The rest of us would have chipped him about it if we had dared, but as he was more than a bit heavy-handed when the fit took him, we thought it best after the first attempt to keep our jokes to ourselves.

We pulled in to the jetty—the ship was lying about a mile out—and as soon as we had made her fast and stepped ashore Baines turned round on us with such a savage expression that it made us all jump.

'Now then, you kids,' he growled in his best bass voice, 'right here is where you disappear. See?'

We didn't see; so without waiting for an answer he went on to explain.

'Vamos—pronto—go chase yourselves!' Baines was one of those fellows who are very fond of airing any expressions they have picked up in foreign ports. 'If you think I'm going to be found dead takin' a lot of greedy gorgin' little squirts out to people's houses, well, you can think again—see?'

Little Timmins's mouth went down at the corners. I almost think the poor little beggar was going to cry. He was the sort of kid that's fonder of eating than of anything else, and we used to call him by a somewhat vulgar nickname that suggested the fact.

I wasn't particularly keen on the tea-party myself. It made me go hot all over to see Baines casting sheep's eyes at the eldest Ferreira girl, whom I secretly thought a wishy-washy sort of creature without a ha'porth of fun in her. But I felt so sorry for the poor youngster that I put up a protest.

'Look here, who're you talking to?' I demanded hotly. 'We're all invited, aren't we? Well?'

I stopped abruptly, because at this point Purkis had caught me a painful kick on the ankle.

'Here,' I said, turning on him angrily as I rubbed my injured member. 'What are——'

Purkis made a most horrible face at me and put in quickly, 'Of course we'll clear off if you want us to, won't we, chaps? *We* don't want to spoil sport.'

Paddy said it was all the same to him one way or t'other; so the finish of it was that Baines went off to his tea-party and his lady-love by himself, and we strolled off in the other direction.

'What did you need a kick for?' demanded Purkis, as soon as Baines was well out of earshot. 'Can't you see this is just the very chance we wanted? I was wondering how we were going to work it to give old Baines the slip.'

'Chance?' I said rather grumpily. To tell the truth, I was regretting our lost tea nearly as much as young Timmins. The Ferreira people used to have a lovely spread, and they were regular dabs at that dainty peculiar to South Africa known as 'confyt', which I can best describe as a kind of super-jam, made of water-melon, figs, and other fruits.

'Why, yes,' Purkis went on. 'We're going out to Sea-Lion Island, of course.'

So far as I was concerned, I'd never given the blessed island a thought since the last time he had mentioned it. But Purkis was one of those

fellows who, once he got a notion into his head, you couldn't get it out without a hammer and chisel.

All the same, I'll admit the thought of those silver dollars did appeal rather, now I came to think of it; moreover, as Doctor Isaac Watts once expressed it, 'Satan finds some mischief still for idle hands to do', and the idea of kicking our heels round Mossel Bay while Baines, as young Timmins elegantly put it, filled himself up till his back teeth were awash, wasn't over and above attractive.

'But look here,' I said, for I still felt a bit doubtful about the venture, 'suppose we don't get back as soon as we think? There'll be the deuce of a row——'

'Oh, that'll be all right!' cut in Purkis. 'Baines won't dare to split, because he's supposed to be in charge of the lot of us. And if he has to cool his heels on the jetty for an hour or two, serve him right, say I!'

'Hear, hear!' said young Timmins. 'So do I!' That youngster was taking the loss of his tea pretty hard.

Paddy, the Irishman, was ready, as usual, to fall in with any proposal that was 'agin the government', so off we went, having first provided ourselves with some bread and cheese, bought at a shop in the town, which was all our combined purchasing powers would run to, and some fruit, which I regret to say was 'lifted' from a convenient garden. However, as fruit is as plentiful as potatoes in that part of the world, I don't suppose any one was the worse for our depredations.

Thus provided, off we started. It was a fairly easy pull out to the island, for the day was calm, and any qualms we might have had on starting were soon forgotten.

'I wonder will we see any sea-lions', said Paddy. 'It's a pity we couldn't bring a shot-gun with us; we might have bagged one o' the creatures.'

'So we might,' said Purkis, 'but I fancy it's the breeding season or something, so there might have been a bother if we had.'

'But won't they be pretty savage if they're nesting, or whatever they do?' suggested Timmins.

'Oh, that'll be all right,' said Purkis cheerfully. 'They're not dangerous.'

The island when we got to it didn't look very exciting. It was really only a barren lump of rock, and what with the droppings of the sea birds that seemed to live there, our shore-going bags were in a pretty fair mess by the time we had scrambled ashore.

I rather think it was the idea of meeting a sea-lion that made young Timmins volunteer to stay in the boat; so we left him and started to explore the island for silver dollars.

I fancy whoever pitched this yarn for Purkis's benefit must have been pulling his leg; he was just the sort of chap that people liked to stuff up with fairy tales. Anyway, we never had a glimpse of a dollar either silver or anything else; and by the time we'd scrambled about the rocks for half an hour or so we were beginning to think the expedition was a bit of a wash-out.

'I don't know about you,' I was just beginning to say, 'but a bite of that grub'—which, by the way, we had left in the boat with Timmins—'would look pretty good to me.'

I ought to explain that so far we had only explored one side of the island. It wasn't very easy getting about, the rocks being slippery and steep, and we'd all of us had a ducking or two already. But on the other side there were two or three little beaches and some caves in the rocks; it was to these that the sea-lions used to go to breed and that is what gave the place its name.

Up to then we hadn't seen a whisker of one. But just as I was speaking there came a most frightful yell from the direction of the boat. We scrambled up the rocks as fast as we could (we were out of sight of the place where we had left the boat), and were just in time to see Timmins haring along as quick as he could go, with a big grandfather sea-lion close on his heels. I don't suppose for a moment it would have hurt him; most likely it was as frightened as the kid was. But no doubt it did look a bit alarming, for it was a thundering big one, with whiskers that stuck out like our Old Man's when he was in a paddy.

Poor Timmins was yelling blue murder as he ran. He must have thought his last hour was come. And just as we came in sight of him he came a terrific purler over a stone, and went rolling head over heels towards the boat, with Mr. Sea-lion on top of him.

The next thing was a tremendous splash and churning in the water, and away went the sea-lion swimming for his life, and towing our boat, which he had somehow got all mixed up with him in his hurry, along in his wake.

We all stood there and gazed after our departing craft. For a few moments I don't think any of us spoke. There just wasn't a word for it.

'Gosh!' murmured Paddy at last, almost reverently. 'Gosh! That's torn it!'



He went rolling head over heels towards the boat, with
Mr. Sea-lion on top of him

I really couldn't help admiring Purkis at that moment. It must have been a facer for him, more than for the rest of us, in a way, since the trip had been his idea.

But that fellow simply couldn't be squashed. Up he bobbed like a cork, whatever happened.

'Oh, *that*'ll be all right!' he said, as soon as he could get his breath, just as if it was the most ordinary thing in the world to be marooned on a lump of rock a couple of miles from the nearest land, with our boat setting a course for the South Pole at a rate of knots.

'See here!' Paddy said, breathing through his nose in a way that always meant trouble with him. 'If

you say "That'll be all right" again, Purkis, I—I'll shove you in the drink.'

'Oh, you will, will you?' Purkis began; and I think the two of them would have been hard at it scrapping the next minute if young Timmins hadn't provided a diversion.

He had picked himself up out of the water he had rolled into, and a nice object he looked as he scrambled up the rocks towards where we were

standing. He'd cut his face pretty badly in his fall, and what with the blood and the dirt and the tears all mixed up together, he was a sight for sore eyes.

'Here, you,' shouted Purkis. 'Didn't we tell you to look after the boat? I've a darned good mind——'

'Well, you shouldn't have gone off like that!' whimpered Timmins. 'It was pretty rotten for me, wasn't it, left sitting in the boat by myself for the whole afternoon? And anyway, how was I to know that a great brute of a sea-lion was going to come at me with its mouth open? I bet *you'd* have been scared! Besides, I was getting beastly hungry——'

I think the same horrible thought must have occurred to all of us at the same moment, for Timmins suddenly stopped short in the middle of his lamentations, and his face fell about a yard. We all stood and looked at one another without speaking, while the realization of this final blow grew in our expressions.

'The—the grub!' Paddy murmured at last.

For once even Purkis was dashed. He didn't even begin to say '*That'll* be all right!'

The worst thing about the whole thing was that there simply wasn't anything to be done about it. We could still see our boat, by this time about a quarter of a mile away. The sea-lion, which must have felt rather like a dog with a tin kettle tied to its tail, seemed by this time to have got rid of its unwelcome appendage, and had disappeared; but the boat, which was bobbing about by now bottom up, was showing no inclination to return to the island.

'Well, there's one thing,' said the ever-optimistic Purkis, at last breaking the silence. 'Somebody's sure to spot the boat, and then they're bound to send out a party to look for us.'

'If they don't take it for granted we're drowned', suggested Paddy cheerfully, 'and leave us sitting here till the crack of doom. That's just as likely. We'll have to draw lots, that's all, which of us is eaten. Unless we take it as read, and fix on young Timmins. He's the fattest.'

'Oh, that'll be—I mean, don't talk rot,' said Purkis. 'We can light a flare when it gets dark that'll be seen for miles. That's if no one tumbles to it before that where we are.'

It was a funny thing, that with plenty of time on our hands we none of us showed any inclination to go on looking for silver dollars. We just

sat down in a glum row along the top of the island, and looked at the boat bobbing up and down on the waves, and at the masts of the *Semiramis* sticking up the other side of the point where she was anchored, and then at the shore, in the hope that we might sight a boat coming out to look for us. Once we did catch sight of a man pottering about on the rocks, looking for 'mossels', no doubt, but although we jumped up and down and waved our arms like lunatics, he never even glanced in our direction.

The day wore on. The sun was very hot, and there was a strong smell of gulls and sea-lions and seaweed. This on an empty inside is far from pleasant, and we all began to feel a bit queasy. There wasn't the slightest sign that our absence had been even noticed; in fact, as Paddy pointed out, Baines wouldn't have finished his tea yet, a thought which plunged us into an even deeper gloom than before.

At last the sun set. A few lights were visible on the shore, and one began to twinkle in the *Semiramis's* rigging.

'We'll let it get a bit darker,' said Purkis, 'then we'll light up our distress signal.'

And now a fresh difficulty presented itself. What was the signal to be made of?

It's a surprising thing how little there is that will burn on a barren rock like Sea-Lion Island. Of course, if it had been the sort of island there is in a boy's adventure story, we could have burned some wreckage, or cut down a tree, or something. But there simply wasn't a scrap of wreckage in sight of any sort or description, and as for trees, well, there wasn't so much as a bush to be seen.

However, we decided that each of us must contribute some article of clothing for the purpose. Purkis gave his shirt, Paddy a pair of socks, remarking that it'd save him a job mending them, and Timmins and I added each a pocket-handkerchief to the collection.

Paddy recalled a story he had read somewhere about a lighthouse keeper who killed some Chinese pirates and used their pigtails for wicks for his lamp. He suggested that we might light up Purkis's head if everything else failed, for Purkis rather fancied himself with a whole lot of hair sticking out in a sort of quiff under his cap.

By this time it had got quite dark enough, and Purkis pulled out the box of matches he had with him, being the only one of us who smoked, and with fingers that shook with excitement opened it and struck one.

F-z-z—sputter!

'Confound the beastly things!' exclaimed Purkis in agonized tones. 'They're wet.'

So they were! It must have happened during our treasure hunt, and no one had given it a thought.

Paddy began to shout with laughter.

'Never mind, Purkis,' he gasped when he could get his breath. '*That'll* be all right!'

The funny side of it struck us all for the first time, and we simply yelled and held our sides. Then, when we'd had our laugh out, we gathered up our various contributions to the signal fire; Purkis put on his shirt again, and Paddy his socks, and we sat down to wait with what patience we could muster for the daylight.

You've no idea till you've tried it what a hard thing an island can be to sit on. I daresay it might have been better on the other side; but that, as we could tell by the barking that went on there nearly all night, was occupied already by the sea-lions, and although we had an idea that they weren't really at all dangerous, you never quite know what wild animals can do when they get their monkey up. Anyhow, there were a whole lot more of them than there were of us, so we decided that discretion was the better part of valour and didn't argue the matter with them.

By the time it began to get light we had a pretty good idea what the crew of the *Admiral van Something-or-other*, that the silver dollars were supposed to have come from, must have felt like when they were wrecked on the island. We were all as stiff as pokers with lying on the bare rocks, and pretty chilly into the bargain, for the wind in those parts comes straight from the South Pole with nothing to stop it.

Purkis said he was going to spread his matches out to dry in the sun, and then when they were dry we could start a fire, and the smoke would be sure to be seen from the land. The rest of us started to look for eggs, but the only ones we found had birds in them, and we hadn't got quite hungry enough for that yet. Presently Purkis came along and joined us, looking a bit down in the mouth, and when we asked him about the matches he had to own that all but two of them had blown into the sea when he wasn't looking.

'Well, here's something that looks as if it might burn,' said Paddy; 'a lump of wax of some sort. Maybe it's one of *Admiral van What's-his-name's* candles.'



Purkis gave a frightful yell and flew at the fire as if he had gone mad

Paddy's find was a piece of soft greyish stuff, which certainly did look rather like a fat candle-end that had got melted.

'It's a piece of resin from some tree or other,' said Purkis. He was one of those fellows who always like to seem as if they know all about any subject under the sun. 'Come on. We'll have a shot at starting the fire. We should get a good blaze with this.'

We cut the piece of resin or whatever it was into thin shavings and spread it on Paddy's socks, and then Purkis, shading one of his matches carefully from the wind, struck it on the rock and put a light to the stuff.

We all sat round on our heels and watched it burn. It didn't burn like a candle, certainly; but there was no doubt about it, it made a lovely fug.

Paddy sniffed.

'Golly!' he remarked, 'what a ripping smell! I never knew my socks smelt like that. It's like something out of the *Arabian Nights*. I——'

But he never finished whatever it was that he was going to say.

Purkis gave a frightful yell and flew at the fire as if he had gone mad. He started stamping on the flames and kicking the heap apart, and then

he stooped down and began to rummage with his fingers among the remains of Paddy's socks.

'Here! What are you playing at?' I demanded. 'What's that?' For Purkis, in the intervals of hopping round wringing his burnt fingers, was gibbering something that sounded like 'candle-grease'. 'Of course it's candle-grease. What about it?'

'I didn't say "candle-grease",' wailed Purkis. 'I said *ambergris*. Ambergris—why, it's worth simply pounds an ounce—and we've *burnt* it!'

Purkis then went on to explain that ambergris came out of the insides of sperm whales, and that people pay no end for it to make scent and things like that of.

'Well, why didn't you say so before, since you know everything there is to know?' said Paddy. 'I thought you said it was resin from some tree or other. You sounded jolly cocksure about it. And it was me found the stuff anyway, wasn't it?'

'I vote we go and look for some more,' I suggested. And off we went, Purkis, for once, not quite so full of himself as usual.

We rummaged about on the bit of beach where we had found the first lot of ambergris, and among us we got two or three more bits, none of them as big as the one we had burnt. And, believe me, we were so keen on the hunt that we never even noticed a boat from the *Semiramis* pulling in to the island until we heard the voice of Pretty Polly, our mate, hailing us.

For all that, we were jolly glad to see our shipmates, and I for one know just what Robinson Crusoe must have felt like when he saw Woodes Rogers's ship approaching his island.

It wasn't long, however, before the first flush of our relief began to wear off. Nobody seemed particularly pleased to see us, and as for Pretty Polly, he looked about as pleasant, as Paddy expressed it, as a calf's daddy.

'There'll be a dickens of a row about all this,' I murmured to Purkis.

'Oh, that'll be all right,' he replied. 'You see, the Old Man'll be so jolly glad we're not drowned all will be forgotten and forgiven.'

As a matter of fact, I was right. The Old Man jammed our leave altogether the whole of the time we were on the coast, as well as stopping the price of the oars we had lost from the boat out of our pocket money.

Oh, yes, the stuff *was* ambergris all right. There was about five ounces of it altogether, and it fetched three pounds an ounce when we got to London. So that, after all, our trip to Sea-Lion Island didn't turn out too badly.

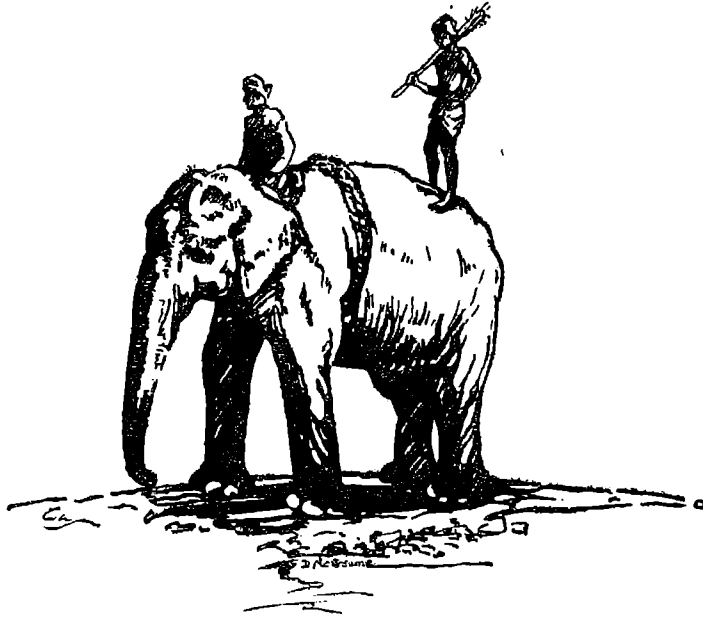

AN ELEPHANT RODEO IN THE HIMALAYAS

By W. ROBERT FORAN

THE most general method employed in the capture of the Asiatic elephant is the *keddah* or stockade system. This varies but little in its essential features whether staged in India, Ceylon, Burma, Siam, Malaya, or Indo-China. In India, however, wild elephants are also rounded up and roped in much the same style as the cowboys cut out steers on the Western Plains of the United States or Canada. The African elephant is also rounded up and roped in the Belgian Congo, but on somewhat different lines from those adopted in India.

At different times and in various lands I have witnessed most of the systems employed in the capture of wild elephants; but the system of rounding up and roping is by far the most exciting and thrilling. It is done much after the style of a Western cowboys' rodeo, and I imagine few have been eyewitnesses of one of these elephant rodeos staged in the Indian jungle.

It was my good fortune to be invited to be present at one of them, and

the opportunity was too good to be missed. It promised to be a unique experience and one long to be remembered. It was all of that! The stage was set in the vicinity of a jungle village, tucked away in a fold of the foothills of the Himalayas. I accompanied the local Raja, my host, to the camp on the day prior to the actual start of operations, and his seventy trained *keddah* elephants lumbered into the camp just ahead of us.

Our camp and the jungle village were astir with the first chill grey of the false dawn. In the mist and dust I could see the foraging squad of *keddah* elephants bringing into camp the huge piles of ficus and bamboo for feeding the seventy giants. From the yellow plain below the camp came faintly to my ears the monotonous throbbing of innumerable tom-toms; thin columns of blue-grey smoke curled lazily upward into the cold air from the many small fires of the scattered encampment; harsh cries and an occasional weird chanting broke the silence of the partially awakened jungle-life; and in my nostrils was the pungent smell of the East and of the elephant-lines.

Presently the mahouts, those masters of elephant control, clambered up on the necks of their crouching mounts; and, one by one, the huge beasts rose to their feet. The *keddah* moved off to the selected hunting area. Gliding noiselessly in single file along the narrow, winding trail, the trained elephants stretched far ahead of us until lost to view on entering the dense jungle. We padded along in their wake. I was perched in a howdah on the back of one of the Raja's *shikar* elephants; and my courteous, picturesquely clad host rode another in advance of me. Only the elephants ridden by the Raja and myself had howdahs. The other animals were stripped for the business in hand and furnished only with a pad, such as is commonly used when out on *shikar*. A rope or two was slung about them, at which the *mugli-wala* clutched from time to time when in danger of losing his balance and falling off.

The *mugli-wala* is an almost naked man who perches perilously on the hindquarters of the elephant. Armed with a stout bludgeon, one end of which bristles with sharp iron spikes, his duty is to belabour the beast with both hands whenever a sudden spurt or some decisive action is required. Experiencing a resounding blow and pin-prick in its posterior regions, the elephant promptly responds to such treatment. The mahout, armed with a hooked *ankus* (harpoon), normally controls the movements of the beast.

Most of the heavy work of the *mugli-wala* is performed from an upright position on the elephant's back, while landing shrewd blows on the rump. The trick of balancing comes only after much practice and many painful falls from aloft.

An army of beaters had left the village afoot long before the *keddah* elephants and, by now, had climbed into the foothills of the Himalayas. Scantly garbed in *dhotis* (loin-cloths), these beaters carried ancient flintlocks, tom-toms, tin pans, quaint horns, and other miscellaneous noise-producing instruments; and this jovial, but highly important, section of the *keddah* was patently out for a frolic. At first, however, the beaters had to cork up their exuberance of spirits. Having heard the terrific din created by the beaters at a tiger shoot in Bengal or Bihar, they seemed to me to be strangely muted. But their immediate task in this elephant rodeo was silently to form a cordon on three flanks of the *nala* in the valley, where the herd of wild elephants had been located by scouts sent out for this purpose.

In order to gain their appointed stations, these beaters had to worm their way up the steep slopes of the hill-side and through dense jungle-growth. Noise was rigidly taboo. The snap of a twig or branch trodden under foot, or a thoughtlessly raised voice, would send the wild elephants in panic-stricken flight to the next valley. They might not even halt there. Once thoroughly startled, the probability was that the herd would be seen no more on that day or for some days thereafter. Then the preliminaries would have to be repeated.

The throat of the cañon was well up in the foothills, being fully a mile in width. During the monsoon seasons the water rushes through it in half a dozen stream-beds, between which are low, thickly wooded ridges; but in the winter months these watercourses are practically dry, and form open, rocky thoroughfares along which slow travel is feasible either on foot or mounted on elephants.

When the *keddah* gained this outlet of the valley it divided up noiselessly into numerous small bands of from eight to ten elephants in each. These various groups took up their appointed positions in the dry watercourses in such a manner as effectually to block the natural avenues of escape for the hunted herd. On the main watershed at the head of the valley, also on the surrounding ridges at either flank, the patient corps of beaters stood on guard while awaiting the signal to start their serious work. In this way was the net spread.

Soon all was in readiness for the *keddah* to begin operations. The preliminaries had been carried out without noise or even words of command, for all knew exactly what was expected of them and just how to do it. Elephant *keddahs* are always notable for the astute strategy, efficiency, and perfection of organization displayed; and even the trained elephants know their tasks backwards. The Raja signalled for me to accompany him up a knoll between the two main watercourses. I followed in his wake on my *shikar* elephant.

From this knoll the entire scene was clearly visible. We could watch the operations excellently from such a natural grandstand. The country-side displayed winding and irregular ridges, the slopes breaking steeply into narrow and rocky gorges; the watercourses had dry beds, dotted here and there with small, stagnant pools; the paths were deep with dust, and the undergrowth was as dry as tinder. Miles away to the eastward the immense, snow-capped ranges of the Himalayas traced their jagged outlines on the blue-white canopy of sky.

No breath of wind relieved

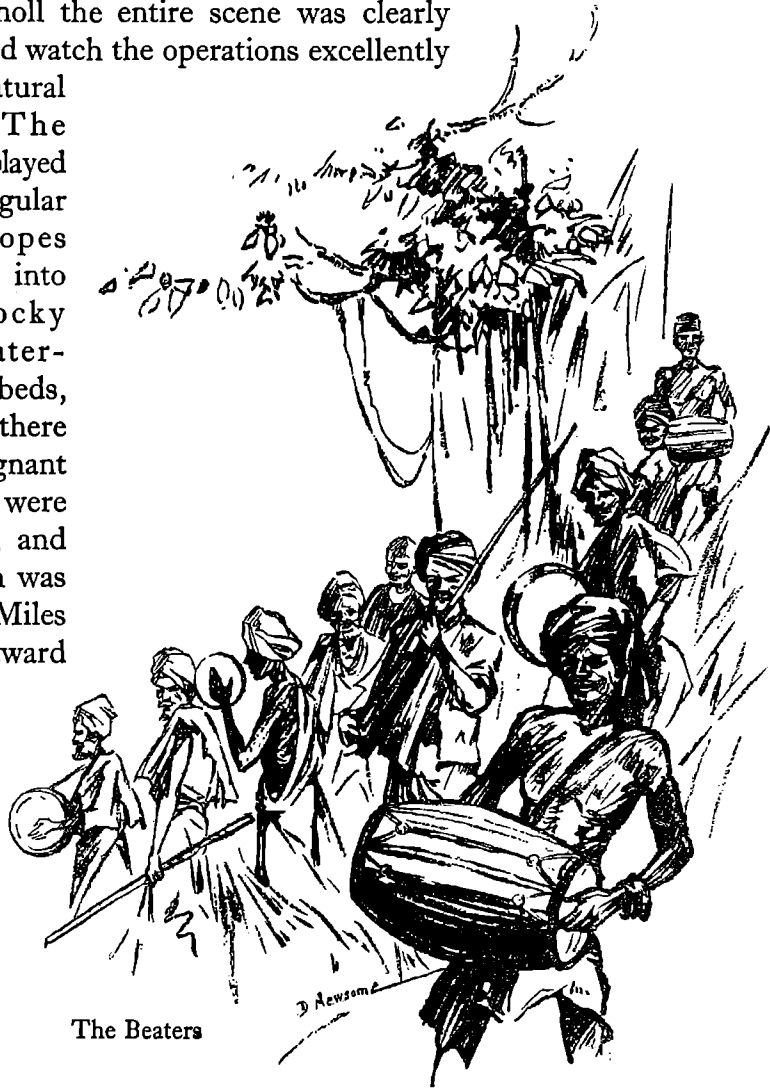

The Beaters

the stifling heat of that dry and oppressive Indian morning. The jungle below and all around us was remarkably still and silent: not a sound came out of it to our intently listening ears. Far below, also on our immediate left, one or two small groups of the *keddah* could be seen quite plainly. The elephants were lazily curling and uncurling their trunks, flapping their ears, and flicking their tails from side to side; while the mahouts squatted on their necks like bronze images of the Buddha, and the *mugli-walas* perched behind them. Both the latter were tense with suppressed excitement, every faculty alert, and eyes straining upward at the wild-looking hill-side. The army of beaters, silent and watchful, were hidden from view in the jungle-growth.

Suddenly a parakeet shrieked shrilly. On the instant pandemonium broke loose upon this restful jungle scene. From the ridges above came sounds of gun-shots, tom-toms beating, high-pitched shouting, and the harsh-noted blasts of the crude horns. All combined to create a furious discord of sound, such as would strike terror into the heart of the most valiant tusker. The beaters were now uncorked and free to let loose their bottled-up exuberance of spirits. The din echoed through the valley, being cast back and forth from hill-side to hill-side like a shuttlecock. The volume of noise and reverberating echoes swelled as the beaters advanced through the jungle towards the herd of wild elephants, which were now surrounded on three sides and being driven towards the *keddah* groups.

Terrified, with the instinct uppermost of escaping quickly from this sudden eruption of noise, the herd headed down the slope of the hill-side at full speed. Seventeen utterly panic-stricken beasts ploughed a clean, wide path through bush and thicket, breaking down the smaller saplings with a sharp report like a pistol-shot, and making the jungle groan and quiver to their stampede. A few moments later they were out of the timber and I could see them plainly. There was one great tusker, four smaller bulls, six full-grown cows with three calves, and three immature cows. I was sensible of acute disappointment at the smallness of the herd within that laboriously cast net, but a quick glance at the Raja's smiling face assured me that he was content with the bag.

Then the thrills and excitements piled up so fast that there was no time even for thought. I completely forgot to get busy with my camera, so lost a rare opportunity for getting some unique photographs. Rumbling down the hill-side to the open watercourse, the herd found itself face to

face with one of the groups of *keddah* elephants; and they came to an abrupt halt in their headlong flight, trumpeting shrilly with mingled rage and terror. The three calves, seeing this strange array of man-ridden elephants blocking the path to safety, made terrified rushes into the jungle, squealing pitifully all the time. For a moment or two the giant bull and his thirteen companions stood their ground, vainly trying to reason out this unusual situation and patently bewildered by the swift course of events. Then they, too, made frantic plunges into the jungle on every side; but they found themselves completely surrounded. What must have been still more terrifying was the fact that the circle of relentless enemies rapidly drew in, while no single line of retreat was offered.

The nearest group of *keddah* elephants was already in hot pursuit of the scattering herd, being soon reinforced by fifty more from a nearby watercourse. The fight was on. Things had to be done with a rush and on the spur of the moment. Each party acted on its own initiative, in accordance with the rapidly changing tactics of the hunted creatures and the nature of the terrain. Events were far too lively and swift-moving for any concerted action or giving of orders; but all knew exactly what must be done, and did it instinctively.

The *keddah* groups were endeavouring to corner each of the wild elephants in turn, and then close in upon the beast. The mahouts shouted crisp orders to their mounts, plying the *ankus* vigorously, while the *mugli-walas* danced frenziedly and delivered stimulating blows to the sterns of the beasts on which they were perched.

The giant bull seemed to be the chief prize sought. The battle for his capture occurred mainly within full sight of the knoll where the Raja and myself were posted. In the strenuous efforts to corral the large bull, the *keddah* was now crashing about haphazard in all directions through the jungle-growth and making heavy seas of the passage; while the din on every hand, to which I contributed my mite, was deafening.

Instinctively realizing that he was about to be hemmed in and effectually cornered, the giant elephant made furious short charges up and down the slope of the hill-side or across the dry watercourse. He crossed and re-crossed the *nala* a great many times. But he was never able to run far without finding himself completely blocked and turned back by one or more of the *keddah* groups. Meanwhile, the trained elephants slowly but surely worked the big tusker down the hill-side and out of the dense jungle-growth;

and always they relentlessly closed in upon him. Every movement was made magnificently. The strategy displayed in attaining their objective was perfect in conception and execution, each manœuvre being timed to a nicety.

Finally, the entire turbulent herd of wild elephants came crashing through a bamboo thicket and thundered out on to the open, dry water-course. Several groups of *keddah* elephants were already there in eager ambush. I was greatly impressed by the patent enjoyment these trained animals derived from hunting down and capturing one of their own wild kind. Rushing into the trap ahead and fairly hustled from behind, it was plain that this bull was beaten and must soon surrender to the inevitable; and the wild tusker knew it, too, for he told the world as much in a mighty trumpet blast of terror, rage, and mortification.

A *mugli-wala's* crowning effort was to spike his *hathi* so effectively that the mahout could achieve the honour of being the first to slip the noose of a stout rope over the massive head of the hunted beast. That was a feat

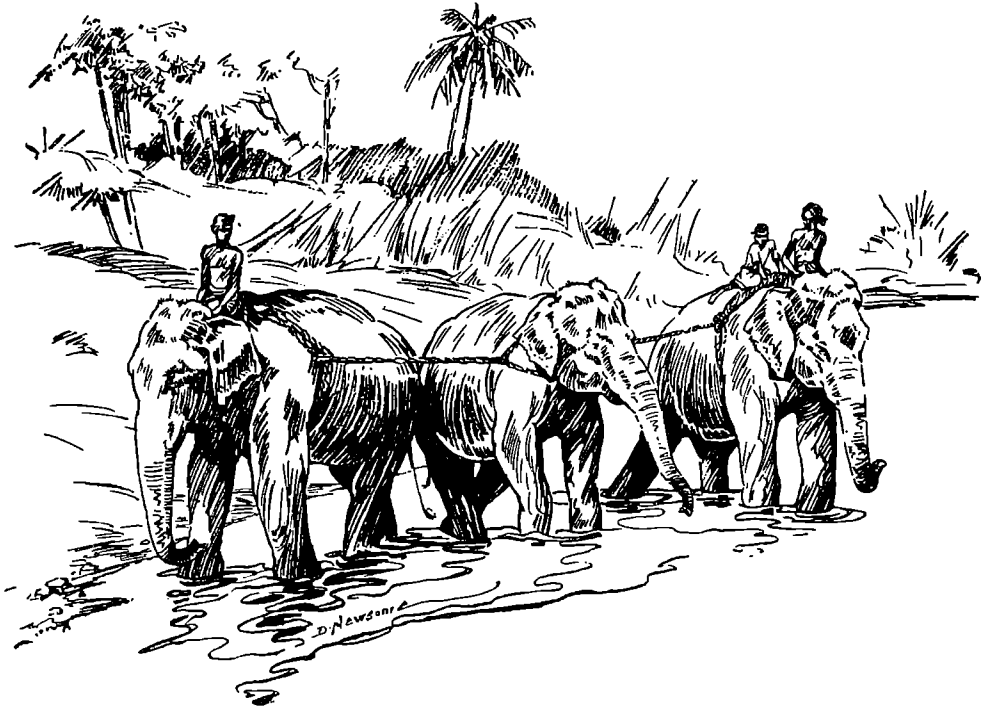

Bringing in the captive

which only an expert could hope to accomplish. Thus was the giant captive securely lassoed and, more or less, brought to a firm anchorage. The rivalry for this distinction was keen. Once securely moored by the head, the *keddah* elephants swarmed about the captive, butted the enraged beast from all angles, and rendered further show of resistance a futility. Agilely slipping down from their *hathis*, the indomitable *mugli-walas* bored their way through the forest of giant legs and waving trunks; and they soon had the big prize hobbled fore and aft.

For the journey back to the camp strong ropes were lashed about the prisoner's head and shoulders to serve as towing-lines for three *hathis* of the *keddah*, who now took the lead; and a stout hawser was also stretched from the hind-legs to a pair of restraining elephants in rear. Thus harnessed, the bull proceeded reluctantly and with many loudly voiced protests on the march to camp. Occasionally on the homeward journey the big prisoner balked with a grim determination; but a few solid butts from the heads of the rearguard soon induced him to move onwards. The halt in the procession was never of long duration.

Whenever the captive refused to budge, the towing-lines snapped taut under the strain imposed by the leading *hathis*. If this failed to convince the bull that he must step along lively without pause to argue, a couple of trained beasts, who formed a sort of flank guard, promptly charged and rammed home their heads. This always jarred the bull loose from any obstinate stance, and called forth loud abuse of the captors. But the treatment proved effective. It was a slow and laboured journey back to camp, but the 'big policemen' knew their jobs and could handle the truculent prisoner successfully. If the bull tried to rush the leaders, the stern ropes brought him up standing; wild dashes to either flank failed signally; and just dawdling on the path brought painful retribution from the free-lance *hathis*. All efforts to escape proving futile, eventually the captive submitted with the best grace possible under the circumstances.

As our journey down the stony bed of the watercourse proceeded the interruptions became fewer. When the spirit of rebellion did flame up once more, the *keddah* elephants literally shouldered the giant along the path until he finally consented to go forward of his own accord. The prisoner really had no chance. Our captive was already learning the first difficult lesson of a long curriculum of education, and to appreciate that independence of action was now a thing of the past. This knowledge

must have been a bitter pill to swallow. The journey back to camp was definitely tempestuous and very different from the peaceful advance made from it at dawn. It ended, however, in the manner desired.

Arrived safely at the camp, the huge captive was securely moored to four great sal trees and thus held prisoner. His training started immediately. This is a surprising and most intricate business, demanding in the trainer immense stocks of patience, an unwavering kindness, and an expert knowledge of the character of an elephant. But the Indian mahouts are past-masters in capturing, taming, and 'schooling' wild elephants; and there is nothing which they can be taught about their profession. Their system has remained unaltered for many centuries. Once captured, the wild beast is allowed to work off its spleen by fighting strenuously to regain freedom until the spirit is broken; and then the training can safely be undertaken. This is achieved by slow and patient stages until the large captive is completely docile, and obeys instantly all commands issued by the mahout.

This particular *keddah* broke up when all the rest of the wild herd was captured and brought into camp. In a year or two the captives on this occasion would have become invaluable aids to human industry; and as likely as not, later on, they would be employed on a similar *keddah* to capture their free-roaming kin in the jungles of India.

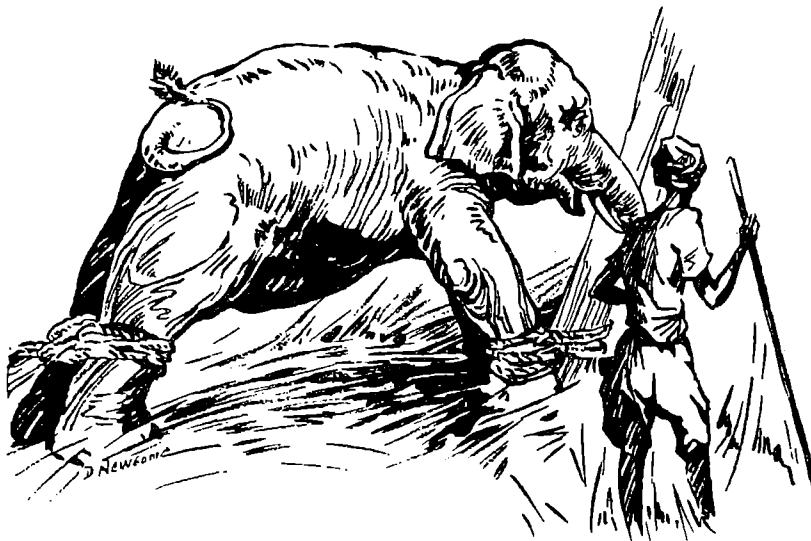



JUST A TOSS-UP

BE wary every time you go
To hunt the cunning buffalo,
And run uphill if he gives chase,
For hills are things he cannot face.
Of course a hill may not be there
And then you offer up a prayer,
For, as in cricket, it is poss-
ible that you will lose the toss.

R. B. v. W.

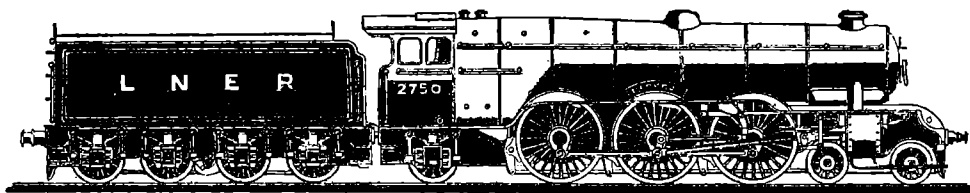

'HOT BOX'

By H. C. WEBSTER

THERE are ills and minor misfortunes that beset the biggest and best of our locomotives in the course of their hundred thousand miles of life, wherever they may be and however perfectly they may be tuned up to concert pitch.

Take the 'Hot Box' for instance, which means an overheating of one of the main axle bearings. It is often difficult to find out why these should overheat at all, but they do, and then the locomotive is invariably a week out of service while the ill is being cured in the Running Shed Shops. It can never be predicted when a really brilliant run will not be completely spoiled and turned into a miserably late arrival by a meeting *en route* with that ogre known to all engine-drivers as the 'Hot Box'.

I remember the case of 2750; *Papyrus* her name was and she was one of the best machines that ever worked a train out of London. A monster of a 'Pacific' that with her tender weighed close on 150 tons. She had big 6 ft. 6 in. coupled wheels and the famous 'Gresley' valve gear that cut off the steam in her three cylinders so that every pound of its pressure was used to the best advantage. A fine steamer was 2750. All the drivers wanted her for their regular engine, but only one had her: Driver Goodridge. He had been in the Main Line Express Link for years and she could have asked for no more skilled master.

Yet all the perfection of *Papyrus* and all the skill of Goodridge could not always elude that spectre of the hot box, and one day it came. They were on the 10.40 up; two stops and a mile a minute average between the Scottish border and London; pretty running that with 16 coaches on, near enough to 500 tons, but it was how she liked it. Just a nice cut-off, a steady pull on the collar, and good stretches of straight where she could top 90 to hold her average.

She had come along to within 50 miles of home; was on time and running

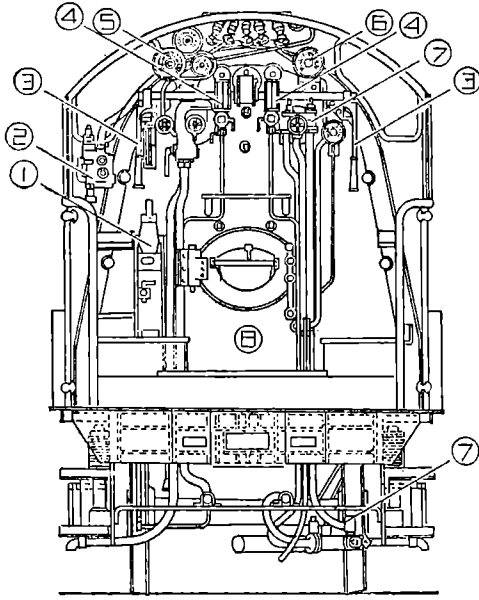

FIG. 1

1. Reversing Gear; 2. Vacuum Brake Ejector; 3. Regulator Handles; 4. Water Gauges; 5. Steam Chest Pressure Gauge; 6. Steam Pressure Gauge; 7. Exhaust Steam Injector; 8. Firehole Door

smoothly when Clarke, the fireman, remarked that a sponge cloth was alight under the footboard somewhere; he could smell it. Goodridge sniffed and said that he at any rate could not, but he told Clarke to 'swill down with the slacker pipe anyway'.

The slacker pipe is a length of rubber hose fitted with a nozzle at one end and attached at the other to the injector delivery pipe. When the injector is feeding the boiler, the opening of the slacker cock releases some of the water, which is forced along the rubber hose and ejected at the nozzle end in a powerful jet. This is used to 'slack' the coal on the tender, i.e. to lay the dust, and also to wash the grease and coal-dust from the footboard.

So Clarke drenched the footplate and resumed his firing. Not a lot more needed now. Just a little at the back corners of the firebox to hold the needle on the 220-lb.-per-square-inch mark whilst Stanton Bank was climbed, and then she would roll the rest of the way into London.

Now *Papyrus* is a 'left-hand drive' engine, which means that the vacuum brake and reversing gear are fitted at the left-hand side of the cab, and the driver's seat, therefore, is on that side also (Fig. 1). This arrangement is a fairly recent development in locomotive design; in the old days railways were thought of in terms of roadways and the driver was on the 'Off' or right-hand side in both cases. Clarke consequently was able to see and hear and smell things that Goodridge, with his head out of the left-hand cab window, watching signals, could not.

And Clarke, in spite of the drenching that he had given the footboard, continued to sniff. He continued to smell the burning sponge cloth. The smell was growing more powerful, too, no doubt about it; his interest was awakened now and he instinctively began to trace its source.

No sign of anything burning under the footboard; no smoke; besides, it wasn't the acrid scent of burning rag; seemed to come from the window on his side.

Clarke put out his head. Now he smelt it distinctly, but there was nothing to be seen; still, he was not satisfied. He stepped across to Goodridge.

'Come and put your head out my side; smells like something's burning.'

Goodridge looked at him and sniffed again, but could himself trace nothing and he was loath to leave his look-out just now; it was hereabouts that the Upton Branch joined the Main Line and at 80 miles an hour the semaphore arms seemed to jump up out of the ground.

Better go and see, though, he thought, for on the footplate of a locomotive at speed no single thing must ever be left to chance. A glance ahead; Upton Home and Starter signals both 'Off', and Manor Road distant, on the Down side under the bridge, 'Off' as well; he had time to step over to the other side of the cab.

In a few seconds he was back again, having discovered all he needed to know.

'What is it makes that smell?' roared Clarke into his ear.

'Burnt oil,' roared back Goodridge.

'Hot box?'

'Hot box.'

The driver put his hand to the regulator, but he held it there before he shut it; perhaps for as long as thirty seconds he paused while what passed through his mind was something like this:

'Can I do it? Manor Road is $45\frac{1}{2}$ miles out, and once up Stanton I can roll down with just a flick of steam to keep her moving; no thrust on the bearing. We've a minute in hand, too, and a five late arrival would be better than a failure. Pretty hot, though; no more lubrication for 45 miles. The oil will burn as fast as it reaches the journal. Wonder how many revolutions that will be—twenty tons on that bearing too—expect it's the driving box—twenty tons—hundreds of revolutions—no oil—45 miles—she'll fire most likely and I'll tear the journal to pieces. No!'

'Snap' went the regulator, and the steady, regular beat of *Papyrus* stopped. A slight hiss of inrushing air and the grind of brakes as the train was slowed down to 50 miles an hour indicated that Goodridge had made his decision.

'Coming off?' asked Clarke.

'Yes! I might have chanced it with another, but I'll not risk hurting this one.'

Clarke turned to his tool-box, for this meant a change of engines, and kits must go with enginemmen; he collected the tools he wanted for himself and his driver, their food baskets and overcoats, and he locked away that little drop of surplus oil saved over from several yesterdays for some tomorrow when a little drop extra might make all the difference.

No need of steam now, so he closed the damper door and re-started the right-hand feed to fill up the boiler with cool water and prevent steam from blowing off through the safety-valves; got to go somewhere since it would no longer be used up in the cylinders.

And Goodridge? He isn't doing anything yet, nor will until Manor Road Up Box comes into sight and he gives the code whistle, 'Fresh engine required at next pilot point'; but his face is set in stern lines, for although he is taking the right and only proper course in giving up his train, to do so is nothing short of a minor tragedy to a driver of his reputation and experience. In no way his fault; just bad luck as later events will show. Still, day after day, year in and year out, this man works the most famous trains in the country, crack Continentals and Pullman Car high-speed flyers, and he works them smoothly, regularly, and punctually. This time he will not do so, and the knowledge is a bitter disappointment.

So he sits, his hand on the whistle. There's the Box! It doesn't seem to jump out of the ground now as so many have done till then, for the speed is down to forty. It's nearly abreast; one more flashing thought: 'Dare I?' and one more quick judgement, 'No', and the code whistle is sounded.

Here, for a time, we will leave the engine and her crew to follow up the consequences of that code signal to Manor Road Up Box.

The signalman is on his way to his window when he hears it, for despite his forty-three years of service, the sight of *Papyrus* and sixteen cars flashing past his box is still one not to be missed for the looking. He mutters, 'Hullo! that's bad; thought she was a long time coming up,' and reaching quickly for his green flag hurries to the window. A wave with it to Goodridge as he goes by tells him that his message had been received and understood, and then he turns at once to his telegraph sending-instrument.

Urgently the Morse Code taps out: 'Manor Road Up Box to Head Control, London. Driver of 10.40 up whistled for assistance 5.58 p.m.

Engine No. 2750, cause not known, smell of burnt oil when passing, is proceeding about 40 miles per hour 2 minutes late here.'

From London a message is telephoned to Redburgh: 'Is that Redburgh Loco. Shed? Head Control here: urgent message. 10.40 a.m. up, Engine No. 2750, 16 cars on, requires assistance on arrival at yours. Reason not known, thought to be hot box. Be prepared, Redburgh; 2 late Manor Road. Repeat please.'

The Redburgh Loco. Depot replies: 'Right, London; 4489 pilot is ready in Up Spur; men on duty 12.0 noon will require relief if they go through, on arrival; be prepared, London.'

So replies the Redburgh 'Running Foreman' on duty before tearing off his telephone slip and hastening with it to the depot Superintendent.

'Goodridge is done, sir; hot box—coming off here.'

'What is he working?'

'10.40 up.'

'The Flyer! That's bad; it'll break his heart. 2750, I suppose?'

'Yes, sir; sixteen on; two minutes late by Manor Road.'

'He'll be due in ten minutes then; what's your pilot?'

'4489, in Up Spur; Harrison on.'

'Good. With sixteen cars though we'll have to double head. One of these days perhaps the powers that be will give us a "Pacific" for these jobs. '89 is no good by herself even in Goodridge's hands. What have you in for the 7.20?'

'4491, sir.'

'Can you cover?'

'Yes; the 6.2 will be in time enough for that.'

'Right; send them both out when she gets here and let Harrison go through. What about relief?'

'I've advised London control to be prepared with a fresh set of men to relieve ours on arrival, sir.'

'Good; they can return passengers, and London work the engines unbalanced. Goodridge will be here any minute now. I'll come out; see that everybody is advised.'

And in the intervening few minutes might be seen the functioning of a well-organized Locomotive Running Shed. Harrison's engine No. 4489 has already been prepared, but he adds a few drops of oil here and there at vital points while his fireman opens the damper to let air to the fire and

the blower to put a draught on it; before Goodridge arrives there will be a full head of steam. Back on the footplate Harrison puts on the injector just to 'top her up' with water and takes a final look round. Coal cracked? Yes. Fire clean? Yes. All tools in place? Yes. Footboard swept and clean? Yes.

No. 4491, with an odd set of men, is moving slowly out of the shed towards Up Spur, where she will be coupled to No. 4489; a fitter and his mate with their bag of tools are walking towards the Loco. Inlet, where 2750 will stop, because the trouble is not *known* to be a hot box; it might be a job that they could put right without detaching the engine, and so save a 'failure'.

A lad is well on his way to the signal-box to advise the signalman what has occurred and what engine movements he will be required to provide for, and a shed shunter is clearing one of the roads in readiness to receive the 'casualty'.

An odd fireman is joining the fitter; he will be found at the exact spot where engine and train must be uncoupled to get a quick release and the fresh engines coupled up. The Running Foreman, watch in hand, is ready to note times of arrival and departure for transmission to Head Control as soon as the train leaves.

The Superintendent is quietly walking towards the Inlet, out of everybody's way but with every movement under his observation. And soon he sees *Papyrus* coming over the brow of the hill, as does the Running Foreman.

'He's coming down with a closed regulator, sir; must be properly hot.'

'Yes. I think it is; we'll soon know.'

And then the grind of the brakes—an unhappy sound to keen locomotive men when it is heard in the wrong place! She should be doing 85 miles per hour past here, but the brakes are on and the Flyer has stopped.

The fireman is off the footplate almost before it has done so and the driver very quickly afterwards, to be greeted by the Superintendent with, 'I'm sorry about this, Goodridge, but you did right to come off; no sense in tearing lumps out of the axle, and you'll have her back that much sooner.'

'I'm sorry too, sir, as you well know, but I'd have done no good stopping on and she would never have got there.'

'That's true; can't be helped. Just bad luck, and even you must have

your dose of that sometimes. We're giving you 4489 with '91 on the front; both are in good trim and you'll not lose any more time once you get away.'

'Thank you, sir, we'll manage; and if you'll be so good as to get my pal up to head-quarters for attention just as soon as you can I shall be grateful.'

'I'll look round her now, Goodridge, and if she is fit to travel I'll work her up light when the box has cooled off; picked up some grit from the ballast, I expect; where were you when you first got hot?'

'My mate smelt it first about a mile yon side of Upton.'

'H'm, six miles from here and as hot as that. Grit wouldn't have done it; you've been short of oil. Well, we shall see when the wheels are dropped!'

Goodridge climbs up into the cab of his new mount, 4489, for by now *Papyrus* has been uncoupled from the train and moved ahead out of the way and the two pilot engines, already coupled together, have been set back and recoupled in its place.

There is a combined 'whistle up', and then that double exhaust beat that so impressively conveys a sense of irresistible power whenever two big engines start away with a heavy load behind them. The coaches move and then begin to travel at increasing speed until only a red tail-light fast disappearing in the distance can be seen to tell of what has happened.

The Superintendent turns to his Foreman. 'Well, what's the damage?'

The Foreman refers to his slip of paper. 'She stopped here at 6.10 p.m., five minutes late, and left again at 6.14 p.m.; that's four minutes for the change-over. She'll lose another two minutes regaining speed, but she'll not lose any more between that and London with those two engines. Goodridge will get the last ounce out of '89, and Harrison will break his back to

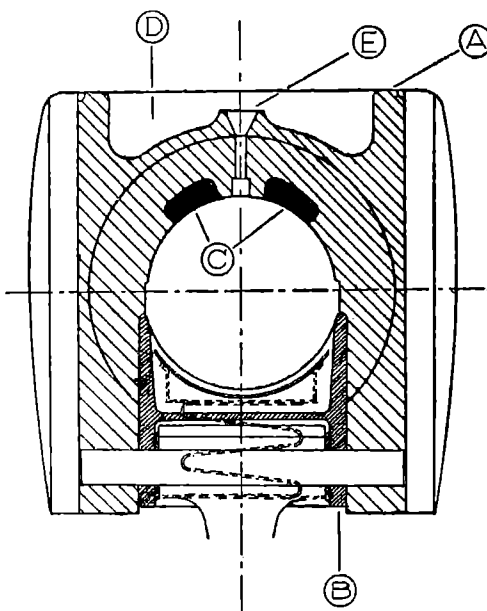

FIG. 2

hold the delay down; he's the sort that will help a mate in a bit of trouble. Say twelve minutes late arrival, it won't be more.'

'Might be worse, I suppose. Have 2750 put into the Shed on a pit road and send round when she's cool enough for me to make an examination.'

That will not be for several hours, for the heating has been severe; everything about that engine is big and heavy and powerful; she could not be puny even in her misfortunes.

But eventually the wheel centre cools to an extent that allows it and the axle-box to be touched and handled, and in the light of concentrated acetylene and vapour lamps an inspection is made.

Now it will be seen on referring to Fig. 2, that a locomotive axle-box comprises two parts: the box proper, marked A, usually made of gunmetal with 'white' or 'anti-friction' metal insets at C to form a bearing; and the 'keep' marked B, which is of cast iron and forms a tray in which is carried a lubricating pad made of cotton. This pad is kept pressed close up to the under side of the axle journal by springs, and keeps it continually cleaned and lubricated; the cotton forming the pad ends in a series of tails which lie in the oil at the bottom of the keep or tray. This oil slowly creeps up the cotton tails and reaches the pad surface, which is consequently always covered with oil.

The oil comes in the first place from the lubricator, which feeds it through pipes to the 'crown' of the axle-box, D, and thence through the oil-hole E to the journal. It will be seen, therefore, that locomotive axle-bearings or journals are lubricated both at the top and bottom.

The white metal used for the insets C is very much like lead and it melts at a relatively low temperature; so that the Superintendent was not greatly surprised, when the keep was drawn out from the axle-box for his inspection, to find that the surface of the lubricating pad, which should have been smooth, clean and oily, was burnt away in places and embedded with pieces of white metal about the size of half a crown.

This indicated to him, as he had expected, that the heating was severe enough to have melted the metal insets and deprived the axle-box of its bearing. It made him doubtful as to how far the journal had itself been damaged.

The removal of the keep uncovered the underneath side of this, so, light in hand, he gets into the pit to examine it. His light throws up definite shadow lines on the journal, which he fears are made by 'cording', i.e. the

cutting of grooves in the material of the axle, and the movement of his hand carefully over the surface confirms that this has been 'scored' or worn by heat and friction into a series of hollows and ridges.

He knows enough now to be aware that the necessary repairs cannot be carried out by himself; Redburgh is an 'out-depot' with only such machine tools and appliances as are necessary to deal with ordinary small running repairs to engines; this job will mean taking out the wheels and axle from under the engine, and that can only be done at the parent depot where there is a wheel-drop.

He turns to the fitter who is with him. 'The journal is cut and all metal out of the crown—a London job. Clean the surface as well as you can and the keep thoroughly, then pack it tightly with clean waste soaked in oil. I think, too, that we'll have a little weight off; say, a couple of threads on each spring hanger to bring it down to about 16 tons. The other boxes will have to carry the extra load; they'll come to no harm.'

To the Running Foreman then on duty: 'Have her steamed in an hour's time and advise Head Control leaving. I want her sent up on the Slow Road, speed not to exceed 30 m.p.h. anywhere, and you must impress that on the driver who takes her. I'll run no risk of further damage to this engine. I shall be 'phoning London myself; it's a job for the wheel-drop.'

Before he leaves to do so, however, an endeavour must be made to trace the cause of the overheating in the first place. Sometimes this is quite easy—a broken lubricator pipe or faulty lubricator, or sometimes water lodges in the keep or finds its way into the crown of the box and washes out the oil.

None of these causes is apparent, however, in the present instance; no broken ends of pipes are visible and no trace of water. Clearly it will be necessary to strip the lubricating system after the wheels have been removed for a close examination to be made of every detail. To do this now would delay the departure, and so a telephone call goes through to head-quarters, who have already been advised of the occurrence itself.

'2750 will be leaving in an hour for yours; right back coupled box badly overheated, journal cut; wheels will have to come out for it to be re-turned. Cause not apparent; left to you to further examine when stripped. Box cleaned and keep repacked and filled fresh oil; weight eased will require re-adjustment after repairs.'

And so in the early hours of a drizzling wet morning as sad and depressed as herself, comes *Papyrus*, pride of the road, limping home to her shed.

Mud-splashed, dirty and bedraggled, with a great scar where the heat has burned the paint from the boss of the right back coupled wheel, she has, for all that, the majesty of power as she towers above the many smaller freight and shunting engines busily bustling about the yard.

A stop for an hour at the disposal and examination pits outside the shed, where the fire is thrown out and the smoke-box and ashpan are cleaned of ash and clinker, and then along comes a fussy little saddle-tank shunting engine which couples up to her and, puffing importantly, pushes and pulls until slowly our patient is negotiated into the Running-Shed Repair Road and to the correct position on the wheel-drop which, to her, becomes the operating table of the depot hospital.

Until quite recently, whenever it was necessary to remove the wheels from a locomotive for any purpose, it was the practice to lift it by means

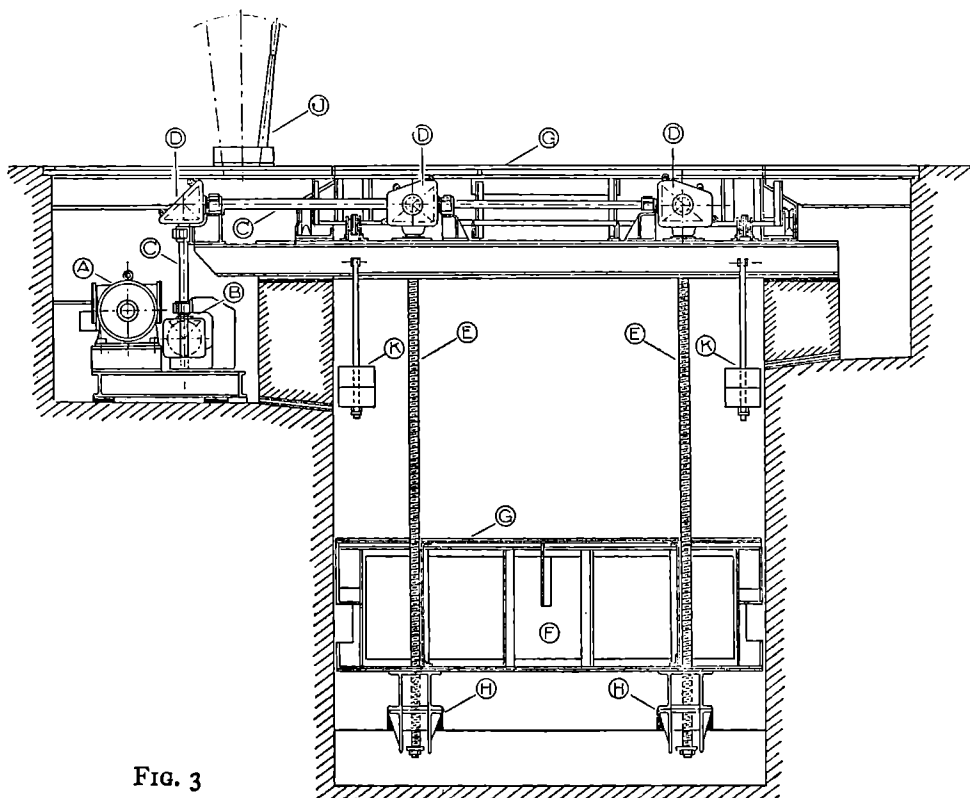

FIG. 3

of an overhead crane to a height sufficient to enable the pair required to be run out. This used to take a good deal of time, occupy a good deal of valuable room, and necessitate the employment of a gang of men to operate the crane or hoist.

Modern Locomotive Shed practice does away with all this, and instead of the engine being lifted up clear of the wheels, the wheels are lowered down clear of the engine.

The appliance used is called a 'wheel-drop' and usually it is electrically operated. It is shown diagrammatically in Fig. 3. An operating electric motor A is connected by bevel gearing at B to a main driving shaft C, which is in turn geared by the bevel wheels at D to four vertical screwed shafts, two of which are shown at E. Each of these passes through the depth of the main girders F, which carry lengths of Bridge Section rail G, and, secured to the bottom flange, long nuts H, with which the screwed shafts engage.

It will thus be seen that as these are rotated by the motor, through the bevel gearing and driving shafts, the girders and the table supported by them will rise or fall according to the direction of rotation.

The engine is set with the pair of wheels to be dropped central on the table when this is in the 'Up' position; the locking bar is withdrawn by pulling over the lever J; the motor is started, and the table lowered to the pit bottom with the wheels on it.

When approximately half-way down, the girders E strike the ends of bar links connected through chains to wheeled runners. These ride upon short, girder-section runways, and carry the continuation rails which by this means are brought towards each other as the table descends, until, when it has reached its lowest limit, they form with pit rails one continuous length, and the engine may therefore be moved off the wheel-drop altogether.

When this has been done, the table and wheels are brought up again, the rails separating under the pull of balancing weights K, leaving a clear way for the table rails to take their place.

In this way the back coupled wheels are dropped from under 2750 and brought up again for close examination and attention. Yes, the right-hand journal is badly cut and will have to be re-turned, and so along comes the shop overhead crane to pick up the wheels and carry them to the other end where they are set in the wheel lathe and a skilled turner commences operations.

Light cuts backwards and forwards gradually restore the damaged surface, and with a 'finishing tool' the final cut leaves the journal as smooth and bright as silver and true to the three-thousandth part of an inch.

Now for the axle-box. All the 'metal' has been melted out, but the bronze body is still sound and fit for further service, so first the box is cleaned and the pockets, c (Fig. 2), deepened a little in a drilling machine; next the surfaces of these pockets are 'tinned' by coating them with a thin layer of solder, and finally they are refilled with new white metal, and the box is allowed to cool down.

When cold, the entire box is taken to another lathe and re-bored to fit the newly turned journal. This fit must be nearly perfect, the two surfaces making contact everywhere; and as no turner, however skilled, could possibly achieve such a degree of perfection, the box and journal are finally hand-fitted, the high parts of the metal in the box that press too hard on the journal being scraped down until the bearing is absolutely uniform over the whole surface.

A new lubricating pad is fitted into the keep, which has been cleaned and recharged with fresh oil, and both axle-boxes are reassembled on the axle. This is run back on to the wheel-drop table and goes down with it to the bottom of the pit, while over the newly formed artificial track *Papyrus* is pulled into position. Steadily the wheels are brought up under her, and carefully the axle-boxes are entered into the 'horns' or guides until they are high enough to permit the spring gear to be connected. Then the wheel-drop table 'lowers off', and our patient leaves hospital.

Not yet, however, is she ready to thunder away north again under the masterly hand of Driver Goodridge, who has been as diligent in his inquiries as any anxious father at a ward door of a hospital.

She must go to the weighbridge where the weight on every wheel is carefully checked and adjusted, and then she must be 'run in', which means sent out to work trains of gradually increasing weight, speed, and distance. A short trip first on a light freight train, then a heavier one, then a stopping passenger train, then a semi-fast while the bearing is given an opportunity to bed itself properly in; and at last the 10.40 up once more.

Shouts Goodridge with a grin: 'Smell anything burning to-day, mate?' But Clarke only grins back as his shovel buries itself in the great, black lumps on the tender.

MR. FLICK PASSES BY

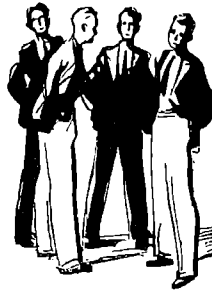

by
Michael Poole

I

I SUPPOSE there will be a good many fellows who can say that the Christmas term of 1939 was just about the queerest that ever happened. It was so at Whitegate.

As a matter of fact Whitegate School ceased to exist in one way. The buildings had been taken over by some Government department and we had been transferred to some place called Nether Clovedale. When my train reached Headley Junction there was quite a crowd of Whitegate fellows waiting for the train to Nether Clovedale.

Four of us, Morley, Huggins, Craven, and I (my name's Dennis) decided to scout round and try to get a cup of tea and a bun. We not only failed to find the tea-shop some ass told us we should find just outside the station but we missed the wretched train to Nether Clovedale.

That was a pretty bad beginning, but we got there all right in the end. Mr. Chidley and two other masters were there to meet us, and, rather surprisingly, they didn't go off at the deep end about our missing the connexion. My impression was that Chiddy had made up his mind to be bright and cheerful, at any rate for this first day, and Mr. Conquest and Mr. Hawkins were taking the same line.

All the Lower School had been fixed up quite comfortably in some place which had until recently been a preparatory school. More than half the Upper School were billeted in two or three large houses quite close together, and the Sixth had also been comfortably fixed up. The Fifth had been scattered round a bit in private houses.

We were the last to arrive, and although the house where we should be staying was about a mile and a half from the Village Hall where the Fifth and the Remove would meet for tuition, Chiddy was quite sure we should be very comfortable and the walk would do us good. Hawky and Mr. Conquest took us along in their cars to Westmead.

It looked a pretty decent place, and Chiddy had mentioned that Mr. Dawson was an Old Blue and that his sister, Miss Dawson, was very charming. It must have been fifty years since old Dawson had rowed in the Oxford boat and I don't think he liked us from the first. That was probably Huggins's fault. He's quite a good sort is Huggy, but one of those clumsy chaps who are apt to knock things about a bit.

We were shown into a sitting-room by an elderly, rather grim-looking maid, and then Mr. and Miss Dawson came in. The room was heated by a gas-fire standing in front of the ordinary fire-place, and after Mr. Hawkins had introduced us, Huggy backed away towards the fire-place. Just how it happened I don't know, and I don't suppose it could have happened to anybody but Huggy. There was one of these padded footstools stuck in front of the fire-place, though I hadn't noticed it until Huggy went backwards over it.

On a film Huggy's performance would have been funny. In this room it just seemed silly. He suddenly gave a little whoop and collapsed backwards into the gas-stove. Mr. Hawkins was jumping forward and shouting out, too late of course: 'Look out!' and was yanking Huggy out of the hearth. The gas-fire had toppled backwards and had gone out with a little plop.

Mr. Dawson standing in the background was shouting out in a thin, excited voice: 'Open the windows! Open the windows—quickly!' and there was a gentle hissing sound from somewhere. Of course I know now that the bang when Huggy knocked the gas-fire backwards had broken it loose from its moorings, so to speak, and the gas was pouring into the room.

Mr. Conquest had grasped that fact pretty quickly and he had jumped forward to turn off the gas, but the place reeked already. However, after the excitement had died down and the maid and the cook had appeared on

the scene, the gas-fire was pushed away in the background and a coal fire would be lighted. The gas company's man would come to-morrow to repair the damage.

Hawky and Conquest left us soon after that, though I think they had a chat with Mr. and Miss Dawson in the dining-room. But I can't help thinking that both Hannah, the cook, and Susan, the maid, took a dislike to us right from that moment. In any case, Mr. Dawson was on a diet and the only time we really saw him was at lunch. Not that he really had any lunch except patent dishes Hannah prepared for him, while Miss Dawson ate less than anybody I've ever seen.

I'd better cut the agony short. Hannah was the world's worst cook, and anyway she'd taken a dislike to us. By the end of our first week we'd forgotten what a decent meal was like. We couldn't even buy anything in the village about that time, as the one or two shops had been eaten out so far as biscuits and chocolates went.

'We shall have to do something about it,' Craven said, and we all made the same assertion. It wasn't only the food, or lack of it; the evenings seemed to be nightmares. We had to be in by black-out time of course, and the light in our sitting-room was hopeless. We actually brought in one or two candles, but of course that led to accidents, especially when Huggy began fooling around.

On one or two free afternoons we scouted round the neighbourhood in the hope of finding some shop, restaurant, or inn where we could get a decent feed. But I've never struck such a scattered, shopless, deserted sort of place. There was, however, another village about four miles away, and on the Saturday afternoon Morley and Huggins went off to Little Clovedale to explore while Craven and I went in another direction.

It didn't seem too hopeful and we must have walked two or three miles and more or less lost ourselves before we saw the notice stuck up at the end of the drive to what looked like a fairly big, rambling farm-house.

'Old Ford Farm. Breakfasts, lunches, teas, &c., provided. Special terms for large parties. Home-grown fruit. New-laid eggs. Week-end accommodation. Ask for tariff.'

'We'll ask for tariff all right!' Craven said. 'Come on, Dennis. It looks a bit deserted, but we may be lucky!'

We were! Just at first we had the feeling that the two bright, smiling, jolly-looking but not so young females who apparently owned the place

regarded us as a joke. In a way it was, as we saw later when they told us something about themselves. Until early September Old Ford Farm had been a flourishing concern even in winter time. Cycling clubs made it their rendezvous and had monster teas, rambling clubs would arrange a date beforehand and turn up even if a gale was blowing, and sometimes there would be a dozen or more putting up here for the week-end.

They employed a couple of men to look after the garden, chickens, and pigs, and waitresses to look after the customers. They made and sold jams and pickles, cakes and fruit cordials. And for well over a month now they had had no more than one solitary guest!

'It's grilled ham and eggs for me,' Craven decided when they told him what we could have. 'With toast, of course. Rather!'

I dare say it doesn't sound frightfully exciting and thrilling, but I've never had such a meal in my life. The Misses Butterfield were glad to see us and hoped we should be mascots. They knew all about Whitegate School having been dumped in the district, and I think they were disappointed that nobody had thought of using this place for billets, or for catering, or some purpose anyway. Instead, they had one solitary paying guest and he would be leaving in a few days. He was a naturalist, or something of the kind, and he never had a word to say for himself.

It turned out, too, that the Old Ford Farm was actually much nearer the Village Hall than Westmead was. We must have walked in a sort of crazy circle before we discovered this place. Before we left we had booked to come again on Monday afternoon and bring Morley and Huggins with us.

We had a couple of hours of so-called school on the Monday afternoon, after a fairly full morning. Afterwards we hung about for a short time yarning with various fellows we knew and hearing all their news. They were all doing very well, and in the evenings there were such amusements as a billiards tournament in one house, and a darts championship in another! There was nothing to complain of about the grub either. Well up to Whitegate standard.

There had been a footer match on the Saturday between the two Fourth forms and some of the villagers had rolled up to cheer. Everything would be in full swing presently. But a couple of fellows had had their wallets emptied and lost six pounds between them. Nasty business that was, but nobody seemed to know how it had happened and there were

rumours that one or two others had lost money. I gathered that Chiddy and the prefects were very worried about it.

I can't say that it worried me much just then. It was hard luck on Waller who had lost three pounds, all ten-shilling notes. What difference it made whether they were ten-shilling notes or pound notes I don't know, and by the time somebody was trying to explain to me the other three were anxious to get along to Old Ford Farm.

The Misses Butterfield were ready for us and we did full justice to the excellent repast, as they say in the newspapers. It might be a bit awkward when rationing started, but they hoped to carry on as they had stocks in hand.

While we were feeding another man came in. A quiet, unassuming fellow he was and we never really noticed him until near the end of our meal. He was having just an ordinary tea and Miss Butterfield whispered to us that he was their one and only paying guest. When he went out he passed by our table, or rather he



He slipped on the highly polished floor and came a lovely cropper

meant to do so. Instead, he slipped on the highly polished floor and came a lovely cropper.

For a moment I thought the poor chap was stunned, but Craven was up in an instant and giving him a hand. The P.G. was on his feet in a second or two and stammered, 'I am so sorry. Thank you very much,' and then bolted.

A shy, harmless, drab little chap he was, and he might have been any age between thirty and forty. He was one of those fellows you'd never notice in a crowd, being one of the meek and mild retiring sort who don't take up much space. Still, he came back for a moment while we were still sitting there. He merely said 'Excuse me' and rubbed the floor with a cloth. Evidently he thought somebody had dropped a pat of butter on the floor and he didn't want anybody else to come a cropper.

I paid the bill and we squared up later. We told Miss Butterfield that the four of us hoped to come along again on Wednesday. There was talk of a practice match to-morrow, and anyway, we couldn't hope to make it a daily custom to visit Old Ford Farm. We were all well in funds but there are limits.

We were right by the gateway leading to the road when somebody called out and there was Miss Mollie Butterfield chasing after us. When she came nearer she held up a brown leather wallet.

'It was on the floor under the table where you sat,' she explained. 'It must belong to one of you.'

Craven recognized the wallet as his at once. A quick look inside convinced him and everybody else. After thanking Miss Butterfield we pushed on to Westmead as it was getting very near black-out time. The long evening didn't seem so bad after a trip to Old Ford Farm!

II

Things were brightening up so far as School was concerned, too. Next day we had a pretty good game on the footer ground, near the Village Hall. There was even a small pavilion, and Baldry, quite an important person on the domestic staff, had fixed up a counter and started a tuck shop. He had quite a decent stock, too, and was even supplying cups of tea!

After the game, Hammond, captain of footer and head prefect, came up to us as we reached Baldry's counter. He was collecting subs at the rate of 3s. 6d. each for the footer club.

'Pay mine, will you, Dennis?' Craven said. 'I'll square with you as soon as I get change from Baldry. Two teas and two pieces of cake, Baldry.'

I gave Hammond a ten-bob note and he was just about to hand me three shillings change when something about my note seemed to puzzle him. He stared at it and then took a postcard from his pocket and examined that.

'Where did you get this note from, Dennis?' he asked, and it was my turn to stare because one doesn't always remember details of that sort. Most likely it was one I'd brought from home, and I said so. Then it came into my mind that I had changed a pound note with Miss Butterfield yesterday. Before I could mention this, and I wasn't too keen about advertising it, somebody called to Hammond. As a matter of fact it was Baldry who wanted to speak to him, apparently rather urgently. Craven turned to me with a cup of tea and a chunk of Genoa cake.

'Baldry hasn't given me change yet,' he remarked, and I looked towards where Hammond and Baldry were each leaning on the counter that had been rigged up. They each held a ten-bob note and seemed to be comparing them. Before we had finished our tea and cake Hammond came back to us.

'Come outside for a minute,' he said, and we gulped down the tea and followed him. Both of us had noticed that he had two ten-shilling notes in his hand.

'Don't get wrong notions into your heads,' Hammond said. 'I'm doing a bit of detective work. That's all. Several others are on the same job and I'm bound to say we hadn't much hope until the past five minutes. Now we may have a clue if you two can help.'

He explained. One way and another there had been a little epidemic among the Whitegate fellows; two boys had lost six pounds between them, as we had heard, but others had also lost smaller amounts. In the two bigger cases all the notes they possessed had vanished from their wallets apparently during the footer match last Saturday, though this was not absolutely certain. In a few other cases fellows had reported, half-heartedly and reluctantly after hearing of others' losses, that they were one or two pounds short. The notes had just vanished at some time from their wallets.

Of course, there was not much chance of tracing pound and ten-shilling notes. But it happened that in Waller's case he had had all ten-shilling notes; they were brand new, fresh from the Bank, and in exchange for ten shillings in silver he had given another fellow one of these notes. The pair of them had noted out of mere curiosity that Waller's notes were

numbered consecutively. As luck had it the fellow who had changed Waller's note still had that one in his possession and they were both dead certain that it had the lowest number.

'So it's pretty well established,' said Hammond, speaking like a judge, 'that Waller had in his wallet six ten-shilling notes and they were numbered 30J 309302 to 30J 309307. They vanished from his wallet some time on Saturday afternoon. He is quite certain they were there all right at two o'clock and they were not there at five o'clock. This note you handed to me, Dennis, is numbered 30J 309306, and this one Craven gave to Baldry to pay for the tea is 30J 309304. How did it happen?'

'Well, it's an absolute certainty that neither Dennis nor I was within a mile of Waller between two and five o'clock on Saturday,' Craven said. 'That's point No. 1. Point No. 2 is that I haven't changed a note until I handed that to Baldry since we came here. Not been spending any money and I had a certain amount of silver. I know just what I had in my wallet, of course.'

He took out his wallet and from it withdrew two one-pound notes and two ten-shilling notes. All of them were folded and all of them, except one of the pound notes, looked pretty new. Craven flicked them open and put them all together, ten-shilling notes on top.

'There you are, Hammond,' Craven said. 'All my worldly wealth, except the change from that ten-bob note I handed to Baldry. I don't see——' He broke off abruptly and then in a different tone asked: 'What were the numbers of Waller's notes?'

Hammond told him and Craven held out his own two ten-shilling notes. They were numbered 30J 309303 and 30J 309305. I looked at my wallet after that but I hadn't another ten-shilling note. Still, between us, Craven and I had held four of the notes which, according to Hammond's evidence, had been stolen from Waller's wallet.

Neither Craven nor I had been within speaking distance of Waller for several days past. Craven was prepared to swear that he hadn't changed any notes for the past week and that these notes must have been in his wallet when he left home for the journey to Nether Clovedale.

I had changed a pound note. That was when I paid for the meals last evening. I told Hammond about that, having decided that I didn't care if everybody knew about it, including Chiddy himself.

'All right,' Hammond said. 'You'd better keep the notes for the present,

but don't part with them. I'll collect the subs some other time and you can pay Baldry without using the ten-shilling notes. It's one of the queerest affairs I've struck.'

He didn't say much more but mooned off, leaving us a bit dazed and irritably bewildered. Obviously we hadn't pinched Waller's wretched notes. It was more likely that he had made a mistake about the numbers. But it was an extraordinary coincidence that I should have a note which ran consecutively with three notes Craven had, and that these numbers should be among the six numbers Hammond had on his list of stolen notes which had been taken from Waller's pocket.

Queer, too, and not very helpful, was the thought that my note had almost certainly been given me by Miss Butterfield. Then I remembered the incident about Craven's wallet and how Miss Butterfield had hurried after us to return it. That led to all sorts of theories and notions and we spent half the evening discussing and arguing about it.

It was nearly supper time when we had the first visitors who had come to see us while we had been at Westmead. As a matter of fact Hannah herself had just dumped the big tray on the table when the ring came at the door. Two or three minutes later Mr. Chidley, Mr. Conquest, Hammond, and some man I'd never seen in my life before came in.

'Don't interrupt the meal,' Chiddy said, still trying to be bright and cheery, but I had an idea that he took stock of that meal. I hoped that he had done so. But it was not about meals he wanted to talk but about the ten-shilling notes. The stranger, Mr. Dymond, asked a lot of questions about our visits to the Old Ford Farm. He even wanted me to describe the paying guest who had nearly broken his neck on the polished floor. I did the best I could but he wasn't the sort of man it's easy to describe.

'Insignificant-looking, on the small side, drab clothes, drab complexion, no outstanding features?' Mr. Dymond asked, and nodded his head as though he quite understood. 'You are going to the farm to-morrow, I understand?'

That was our intention, of course, but we wondered whether Chiddy would put his foot down on the notion. Craven suggested that he might ask Miss Butterfield whether she knew where she had received the ten-bob note she'd given me.

'No, no, no!' Mr. Dymond said. 'Leave it in my hands. I suppose you'll be going there about four to half-past to-morrow?'

We admitted that we should and Mr. Dymond talked a bit more, after which they all said good-night and left us. Why it had been necessary to have four of them on the job of finding out whether we were going to Old Ford Farm to-morrow I didn't know. Neither Hammond nor Mr. Conquest spoke more than half a dozen words while they were in the place. Of course, they'd come in Conquest's car, so in a way it wasn't his job to be interested in the mystery of the ten-shilling notes.

However, soon after four o'clock on the Wednesday we were in the dining-room at Old Ford Farm. I had an idea that Miss Mollie Butterfield who waited on us was a bit stand-offish to-day. The elder Miss Butterfield never even came in to see us. But the meal was top-hole and we were getting ahead in great style when in came Chiddy and Hammond, followed by the man Dymond and another stranger. They nodded to us and sat down at another table as though they weren't really interested in us. Then Dymond strolled over to our table.

'Ah—don't go until I give you the word,' he said. 'We may want to see you presently.'

That was all. We finished our meal, but I'm bound to say that it had not been quite such a cheery show to-day as it had been on the two other occasions. All except the new man at the other table had tea and toast, but I noticed that Dymond's friend did very well with grilled ham, eggs and toast.

We finished our coffee but still sat there. It began to get painful and none of us could think of anything to talk about. Miss Butterfield came in but passed us without a word, and I realized that the paying guest had now turned up. He sat in his own corner and as Miss Butterfield had now switched on a light I had a pretty fair view of him. Not that he interested me; I've never seen a chap who looked less interesting or talkative than he did.

Presently Mr. Dymond and his friend got up from their table and I thought they were coming to speak to us. As a matter of fact Dymond did stop for half a second to say to me: 'Stand by the door for a minute or two, will you?'

I took it that he meant the door leading to the little hall. By the time I'd risen and taken a few steps across to the door Dymond and his friend were speaking to the little man at the table in the corner.

'Hello, Flick!' Dymond's friend said, quite cheerfully. 'Fancy dropping



I made a wild grab for him

across you here! It is a surprise. Business pretty good? I hear you had a nice little haul last Saturday.'

The little man who had been addressed as Flick looked up and I don't think he even looked surprised.

'I beg your pardon,' he said. 'I don't think I have the pleasure of knowing you.'

'That 's a good one, Flick. Just to remind you, I'm Detective-Sergeant Andrews, and a lot of people know me in the West End, especially the gentry with light fingers. You'll come along quietly, Flick? We've been up to your bedroom and collected all the evidence, and we've everything cut and dried for you about the officers' mess at Windways, even to your fingerprints. You can tell us all about it later. Come on, Flick!'

The man they called Flick had stood up and seemed to be blinking in puzzled wonder. Dymond had stepped round one end of the table and Detective-Sergeant Andrews was moving round the other end, quietly but with a sort of determination.

Just how Flick managed it I don't know. One second he was blinking and looking a bit stunned; the next second a jug of hot water was going buzz into Andrews's face, and one-fifth of a second after that, as Andrews's arms were still coming up to keep off another shower, a cup was flung into Dymond's face and then the table seemed to be flung round.

Before I had quite grasped it all Flick was right on me. I made a wild grab for him, suddenly realizing why Dymond had stuck me at this door. I managed to get my arms round his waist but never quite got a real grip. Something that was a good imitation of a sledge hammer caught me well and truly under the jaw and for a few seconds the room seemed to be full of stars and comets. But I knew I'd hit the floor with a real bump and had a dim notion that Flick was mixed up with a human whirlwind. Then Flick came down on top of me, knocking all the breath out of my body and somebody else came on top of Flick.

They rolled off me and, still pretty badly dazed, I managed to sit up. There was Craven kneeling on Flick's chest while Detective-Sergeant Andrews, looking red about the face and limp round the collar, was fastening bracelets round Flick's wrists. Somewhere a whistle was giving a quick blast.

'All right, Flick! You'll come quietly now?' Andrews asked, and then turned to me as I managed to get on my legs again. 'Well done, youngster. And you, too!'

The last was to Craven, who stood back a little and was pulling his tie straight. Somewhere behind him Mr. Chidley and Hammond were standing, and judging by their expressions, they had enjoyed the excitement. For the moment my jaw was hurting too much for me to smile. I had the feeling that it would never move properly again. Flick had a punch all right.

Two policemen came in and Dymond with them. How he'd managed to get out so quickly I don't know. But they took charge of Flick, who looked a poor, weak, downcast little fellow now. We knew later that Dymond was the local detective officer for the district. He went out after a brief word with Andrews; so did the policemen with Flick.

The drama was over and Andrews left soon after. Really and truly it was not until the next day we heard the whole yarn. Chiddy had decided to go to the police about the money being stolen. From what we told Dymond later about the Old Ford Farm the detective decided that the paying guest who had slipped on the floor was a much-wanted man. Apparently Flick was considered the most expert pickpocket in London, but every now and again he vanished from the West End when the police were getting too keen on catching him.

Lately he had evidently been operating in districts where there were camps, or where boys from some of the public schools had been dumped. He had reaped a pretty good harvest, one way and another. The difficulty about his methods was that it was extremely difficult to get proofs. Flick was usually careful not to take anything easily identified.

That was probably the reason why he had passed on a ten-shilling note to Miss Butterfield, or he may only have discovered it then; maybe it wasn't much of a risk, but the fact that he had taken a little bunch of new ten-shilling notes, numbered consecutively, was the sort of thing that Flick didn't like. That was why he had played one of his favourite tricks when he fell down near our table. He had lifted Craven's wallet when Craven was helping him, but had returned it later, or slipped it under the table, with some of the new notes inside instead of the old ones Craven carried. Flick probably thought that was a brain-wave as it might turn suspicion towards Craven, if a record had been made of the notes' numbers.

The Misses Butterfield, of course, had had a nasty shock when they realized their paying guest was 'wanted' by the police, but they played their part all right. Fortunately, too, so Chiddy told us, Andrews had

taken Flick to London to answer a bigger charge there. Moreover, they had found certain silver articles, one or two gold items, and quite a wad of Treasury notes, all nicely tucked away and locked in his case in the bedroom at Old Ford Farm.

'An unfortunate case, of course,' Chiddy told us as he stood in the sitting-room at Westmead. 'I gather, however, that the police will return all the money which this man known as Flick took from our boys. Very satisfactory! And now—ah, ah—there's one other little matter I wish to mention to you. Miss Dawson has been having a talk with me, and although she is most anxious not to make any complaint—Ah, here we are, Miss Dawson! Here we are! Ah, ah!'

Miss Dawson came in, looking frightfully worried I thought. Old Chiddy went on in that lecture-room manner of his, saying that he was just explaining to the boys, and she had explained to him, and as he had explained to her, and as we all understood, there was a war, but nobody was making any complaint. Far from it. He quite understood, and although the boys would be sorry to leave, there it was, and fortunately he had been able to make further arrangements which would also help in other ways.

It took me quite a long time to grasp what old Chiddy was driving at, but I'll put it down at once. We were leaving Westmead that very day. The Dawsons had never really been happy about it and Hannah had given notice twice. But we were parting very good friends. Chiddy said so. He talked about the new billets he had arranged for the four of us, with probably two or four more Fifth-formers. The billets didn't sound too good to me—until Chiddy told us as we squeezed into his car.

He'd fixed up with the Misses Butterfield! We were going there this very day. Probably they would have eight of us. Moreover he was 'commandeering' the dining-room as a form-room. Chiddy spoke as though he'd been frightfully clever in discovering Old Ford Farm. But there was a little twist about his lips, and I'm beginning to think that Chiddy has a queer sense of humour as well as a quick eye and understanding mind, though I didn't always think so.

I've written this at Old Ford Farm. I don't know what really happened to the man known as Flick and I've never seen Andrews or Dymond since. Waller had his money back all right and so did the others. As a matter of fact the police found quite a lot of stuff besides wallets and notes in Flick's

bedroom. Nothing heavy, of course, but rings, brooches, cigarette-cases, and that sort of thing.

But, as Chiddy told us, Flick was really too clever. Apparently he was certain that the masters would keep quiet about the thefts at first, being afraid lest it should turn out to be one of the boys. When they discovered that one of the older boys actually had the notes, as Flick calculated they might do after he realized they were new and consecutively numbered, the police would certainly never hear about it. He had already given one of the notes to Miss Butterfield but that wouldn't matter much. In two or three more days Flick would have passed on to his next hunting-ground.

Chiddy as it happened never suspected that Whitegate fellows were responsible for the thefts. That was why he went to the police so promptly. Probably Flick didn't realize it, but every police-station in the country knew about him, though his description didn't help much. Dymond had a bouquet from Scotland Yard for his quickness.

There are ten of us at Old Ford Farm now—and there are no complaints!

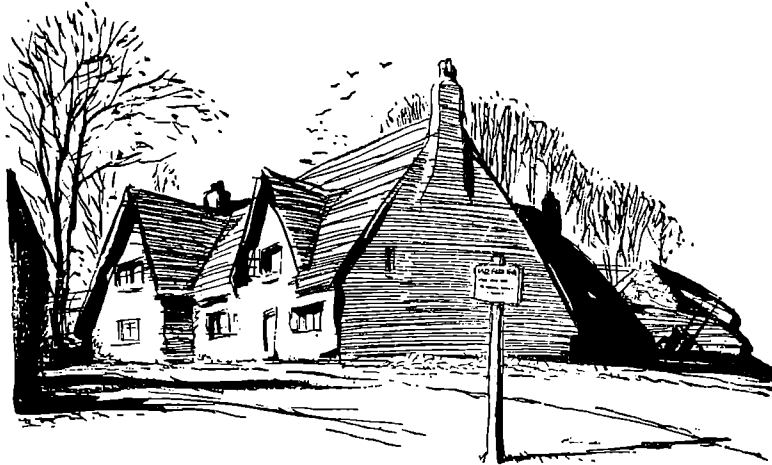



FIVE HUNDRED POUNDS OF SHARK FOR COMPANY

By GEORGE S. SURREY

I AM not prepared to swear that the shark did actually weigh all of five hundred pounds. On an ordinary fishing trip like ours it isn't usual to take along the kind of apparatus that will weigh up to such poundage. But the two native boatmen along with us, the owners of the boat, estimated five hundred pounds as the creature's weight, and none of us was prepared to doubt them. They were men of Trinidad, around which island the ocean seems to be as full of sharks as a pea-pod is of peas; their experience of sharks began at near-babyhood, and what they didn't know about the brutes was hardly worth knowing.

And anyhow, when you're dealing with a fish by the hundredweight, a few pounds either way doesn't make a lot of difference. I know that when we were hauling the brute alongside and into the boat, we felt as though five thousand pounds were at the other end of the line.

The necessary leave had been obtained from the College, and we expected to be back again sometime during the forenoon of the next day—Sunday. We—there were four of us, not counting the boat-owners—left Port of Spain during the early morning and under a glorious sky were soon driving westward across the Boca del Drago (Dragon's Mouth), the narrow sea that separates the top end of Trinidad from the mainland.

We were on pleasure bent, but that is not to say that our craft owned many of the qualities of a pleasure boat. She was a native-built boat and

carried an outboard motor, but she certainly had not been built for comfort. She leaked horribly, but I think the dirt she carried was her most striking feature. And she smelt vilely. But she could move, and she was cheap to hire—a consideration that appealed to us strongly. For twenty-four hours or so we were prepared to put up with her obvious defects.

Our immediate object was Cristobal Colon, a little town situated near the end of the promontory forming the north side of the Gulf of Paria. This call at Cristobal Colon was a necessity, as the tiny island which was our fishing objective belongs to Venezuela, a country somewhat jealous of its rights; therefore it was requisite to obtain a permit for fishing within territorial waters. We had expected some slight trouble about this permit, Venezuelan officials being afflicted with acute suspicions where Europeans are concerned, and liable to surmise ulterior and nefarious motives behind even ordinary requests.

However, we were agreeably disappointed. Our business stated, the official gave one glance at our drill shirts, and khaki shorts and stockings, and exclaimed: 'Ze Boy Scouts! Ah, yes; eet ees all ri'. We give ze permit with pleasure.'

Leaving C. C., having given courteous thanks, we were soon within easy distance of our island; the motor was shut off and we began to fish.

Having done more than a bit of fishing around the English coast, I can easily imagine how the ordinary British sea-angler would have envied us. The Caribbean Sea—parts of it anyway—teems with fish, and fish well worth the catching. There are fish of all shapes and sizes, fish of the most unbelievable colours. Some are poisonous, others are tip-top eating. The barracouda will run up to six feet or more in length, will weigh up to sixty pounds, and looks like a Brobdingnagian pike. Swimmers do well to be wary of him. There are queen-fish and devil-fish, tarpon—and sharks. And the beauty of it all is that the normal question is not, 'I wonder if we'll catch anything', but 'What shall we catch?'

We were mostly concerned with king-fish, decent fighters that will average about twenty pounds, and we were not kept waiting long for bites. Half a dozen were soon hauled in, to flounder for a while on the bottom boards. Of course, we were fishing with handlines.

After a while it became evident that our luck had changed. Instead of catching fish we were hauling in simply fish-heads. Line after line came in with just a head and a bit of shoulder hanging from the hook. The

116 FIVE HUNDRED POUNDS OF SHARK FOR COMPANY

reason needed no asking; there was a shark around. Presently we saw a tell-tale fin. Instead of fishing on his own account in a sporting manner, the lazy rascal was satisfied to snap our catches from the lines as soon as the fish were hooked.

As there is no known method of compelling or persuading such a spoilsport to clear out and go and catch his own dinner, our only form of redress and hope of getting on with our sport was to catch *him*—if we could. Fortunately, our boatmen had not forgotten to bring a shark line with them, and before long we had it in the water with a tempting bait attached. We had not long to wait. There was a bite, a mighty tug, and the line ran out like greased lightning. For quite a while all hands were kept busy and on the *qui vive*.

In due time, after having been within an ace of capsizing half a dozen times, we managed to get the shark near enough to get a good look at him. And weren't we excited! Gosh, but he was a whopper! Something drastic had to be done. To cut the line would have been a huge disappointment

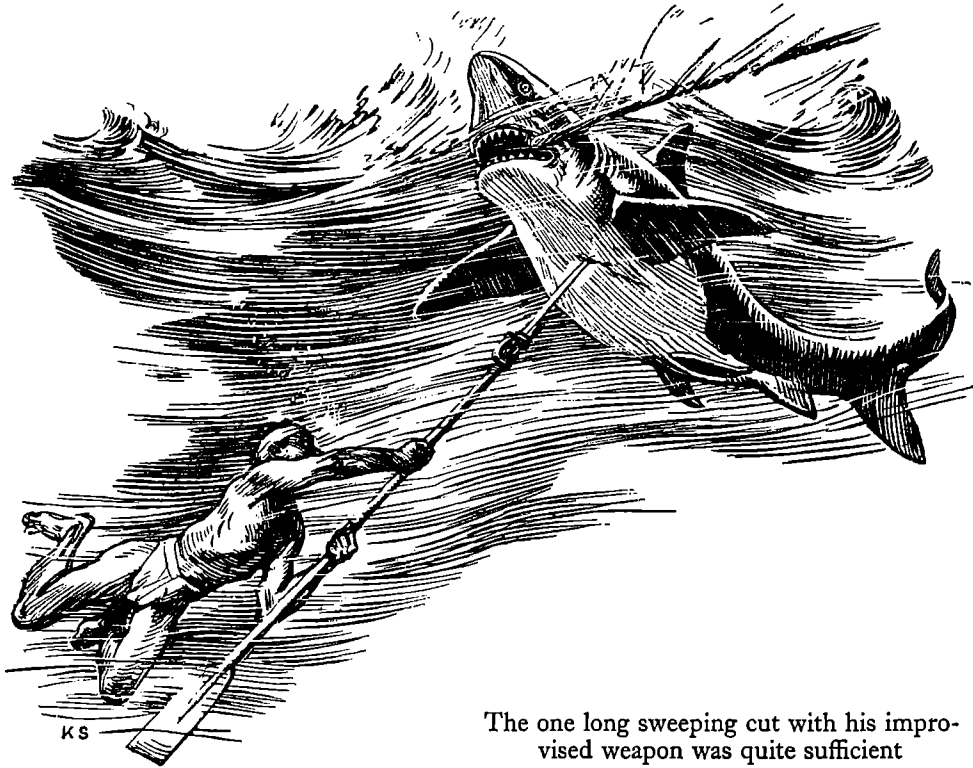

The one long sweeping cut with his improvised weapon was quite sufficient

to that one of our party interested in zoology. But dealing with a five-hundred-pound shark with bare hands is not advisable.

One of the boatmen was equal to the situation. Aboard was an ancient but sharp cutlass. This he bound firmly to one of the oars and with it slipped overboard. A risky proceeding seemingly, for our shark was not at all disposed to remain placid; but the boatman knew what he was doing. There was a sudden violent flurry in the water, the blueness of which overside was deeply tinged with crimson, and almost immediately after the Trinidadian hauled himself aboard, looking very pleased with himself.

The one long sweeping cut with his improvised weapon was quite sufficient. After a while the shark's floundering and threshing ceased, and with all hands lending their help, the carcass was hauled inboard, to lie athwart the forepart of the boat.

At this point a sudden squall swept over us, driving the boat in the direction of the little island. This meant real danger, for the part for which we were heading was pretty steep-to, with a number of ugly-looking black rocks sticking up from the sea about the foot of the cliff. For the moment the shark was forgotten. One of the boatmen dashed aft to start the engine. It started all right, but we might just as well have been without it, the weight of the shark forward being so great that the propeller was well above the level of the heaving, creaming water.

For twenty seconds some vigorous Trinidadian conversation was flying about. One thing was certain; if we were to save the boat from being dashed to bits among the rocks, the shark would have to be got overboard. And a mighty hard—not to say filthy—job it was getting him there. With desperate haste we heaved and hauled until at last the huge body slid over the side. But the fishing line and the rope noosed about the body were not cast off.

The next hour was anything but agreeable. Our party took it in turns sweating at the oars, but even with such help, the engine could give us little or no headway against the force of the wind and sea, and disaster seemed easily possible. We had been driven to within twenty yards of the cliff, and some one suggested the possibility of diving over and swimming and scrambling ashore; but the sight of three or four triangular fins showing now and again among the waves that dashed over the rocks was quite sufficient to knock that idea on the head.

At last the boatman not attending to the engine succeeded in rigging

up some kind of a sea-anchor. That steadied the boat (to the relief of three of our party who had been attacked by violent *mal de mer*) and at the same time acted as a powerful drag against our being driven ashore.

As suddenly as it had arisen the squall ceased—to our immense relief, for the boatman announced that the engine also had ceased to function. At the same time we became aware of the fact that the afternoon was well advanced: the sun gave notice of the immediate approach of evening.

'Lucky if we get back to-morrow morning,' some one said gloomily. He was more than right.

The two natives were at work on the engine, and when we inquired what was the trouble, they explained that the starting handle refused to engage. 'But we put um right; five minutes.'

Half an hour slipped by, and both men straightened up leisurely. The engine was still obstinate; it refused to get going. They did not propose continuing to work on it.

'But it won't put itself right,' the zoologist protested.

'We try um again—bimeby,' he was cheerfully told.

Further questions elicited that 'bimeby' did *not* mean that day. We looked at each other doubtfully. Our special leave was up by Sunday noon, and with even the earliest of starts next morning, getting back by midday was out of the question. We mentioned this.

'Dat all ri', boss,' replied the elder boatman. 'Have to take um to pieces. We do it fust t'ing t'morrer. We quite comf'able here, boss. No mo' squall, no mo' sea. We be all right, sah.'

There was no help for it; without the engine there was no getting back to Port of Spain. Case of Hobson's choice. What did worry us was that we had practically run out of grub. Only a few biscuits were left and our stock of water was short and unpleasantly warm.

Another thing began to worry us—sleeping. A couple could stretch out on a seat below the gunwale of the boat's forepart; the other two would have to be content with the bottom boards, now well covered by the water shipped while trying to get the shark aboard and overboard. We tossed a coin. My luck was out. With dippers and cups we hurriedly set to work bailing.

It was the sort of job any one would wish to get through as speedily as possible. Bilgewater itself is not exactly *eau de Cologne*, and when combined with the drainings from our fish, *and* the oil, blood, and slime exuding

from the carcass of the shark, well heated by several hours of tropical sunshine, the result is a trifle overpowering. Those who had already been seasick were compelled to beat a hasty retreat after a very few minutes.

I've no doubt that each of the four of us found it a very long night. Whether I and my companion in distress did get any sleep is doubtful. Lying at the bottom of the boat with one's nose within a few inches of those odoriferous bottom boards possibly induced periods of intermittent coma, but as a night's rest it was something of a failure. The two natives, case-hardened, slept soundly if not quietly. During my long spells of consciousness I heard them snoring away most abominably out of harmony.

Shortly after sunrise they awakened, and without any urgings set to work upon the engine, a labour that seemed to require as much vocal as muscular effort. Their tools were few and poor, but they were as cheerful as a couple of crickets, and peals of laughter punctuated their good-humoured squabbings.

During the three or four hours necessary for the disruption and re-assembling of the engine our party busied itself with what for courtesy I will call breakfast; and when that distraction ended (pretty quickly), it occurred to the zoologist that we might as well haul up the shark again and see what could be done towards his achieving an ambition to possess the skeleton of its head.

A thoroughly messy job, not improved by the action of the sun's heat and the fact that clasp-knives were our only tools. However, we did get most of the flesh off the bones, hacked through the spine, and let the body drop back into the sea.

Very soon after it was announced that the engine was in working order, so we up-anchored and crept away from the island.

Four hours of slow progress—for we had the wind against us and a nasty cross-sea to negotiate—and then the blessed engine without giving the slightest warning again broke down. Coercion and persuasion were applied in vain. It flatly refused to do its stuff.

'Nossuh,' said the elder boatman, shaking his head, 'we done all we know this mo'nin'. De debbil's in um.'

'Well, but we've got to do something,' the zoologist protested. 'We can't stay here for ever. What's to be done?'

'De dear Lard on'y knows, sah,' the man said simply.

No one of the four of us knew the least thing about outboard motors,

but in sheer desperation, singly and collectively, we worried that infernal engine, breaking our nails and gouging bits from our knuckles. Needless to say, we accomplished nothing else. The boatmen raised no objections. Fatalists, they'd done all they knew, and now squatted on one of the seats, elbows on knees, staring blankly across the heaving sea.

The prospect was certainly anything but cheerful. The chance of being sighted by any craft was extremely thin, the Dragon's Mouth being no sea highway. True, we still had the oars, but any hope of being able to pull back to Trinidad was too slender to offer encouragement, considering the distance, the broiling heat, the lack of food and, above all, water. There was no disguising the truth that we were in a critical position.

'Can't be cured; must be endured,' Tony summed it up. But for how long could we endure?

Night fell, out came the stars; we more or less resigned ourselves to the inevitable. But if the boatmen slept, none of the others did except for a few minutes at a time.

Another morning. No one spoke; no one had anything to say that was worth saying. In silence we shared out the tiny quantity of stinking water. The wind was blowing more strongly, still against us, and there was a nasty sea, waves breaking over the bows from time to time. We bailed it out—mechanically, not because any one felt it was worth while doing.

Towards midday the younger native stirred himself and staggered towards the stern. He stopped beside the engine, staring at it with dull anger.

'You ——!' he muttered, and kicked at it with his bare foot, striking the starting lever.

And, as though the engine had been waiting for this impulse, it sprang to sudden life. What had been the matter with it we never learned.

It was early evening when we nosed our way into the harbour, tied up, and stumbled ashore. We owed our lives to something very like a miracle, but it was the need to satisfy our raging thirst that was foremost in every man's mind. When in due course we were back at the College and explanations given, we learned that the authorities, alarmed by our non-appearance when expected, had made arrangements for a government sloop to leave that night to make search.

Not until many a long day afterwards was it that we made any further attempt at shark-catching, and then it was nearer home.



THE WANDERER SWUNG INTO THE WIND AND TACKED FOR THE STEAMER

(See *No Pirates Nowadays*)

AUTOMOBILE PRESS TEST

By J. HARRISON, A.M.I.MECH.E., A.M.I.A.E.

WHEN a motor-car manufacturer devises a new model he first subjects it to his own extensive and rigorous test, but, before marketing it, he produces half a dozen examples which he lends to independent authorities for trial. Among them are inevitably the testers employed by the technical press.

There are numerous reasons for this procedure. One of the most important is that, as these gentlemen drive every make of car in turn, they have a degree of experience that cannot be equalled by the works staffs. They know what every car in that particular price and size class is capable of, what are its attractions and drawbacks. They can direct the manufacturer's attention to some small points that his own testing staff may have overlooked.

Before the tester arrives at the works he will have already studied the specification. A few questions to the service manager will clear up some points about which he has doubts. He will be careful to check up the mileage that the car has covered, for this affects its performance and, therefore, his conclusions. A new vehicle is a hopeless proposition, for it is so stiff that it is impossible to judge what its performance will be when it is properly run-in. Even a car that has as much as 2,000 miles to its credit will seldom show the maximum speed of which it will ultimately be capable. On the other hand, a vehicle with a lengthy mileage to its credit will have developed rattles and taps inadmissible in a new machine.

Within a very few miles of his taking over the tester is thoroughly familiar with the car. His skilled eye, ear, and touch have already detected more things than its ultimate owner, unless he is unusually experienced, will ever discover.

The first thing that must be checked is the speedometer, for it is necessary to have absolute accuracy and these instruments exaggerate by a varying amount. The makers say that they have to produce instruments that read fast because all motorists like to brag about their prowess as speed drivers. Most owners of popular 8 h.p. saloons who boast of their 'seventy all the time, old boy' would be both pained and surprised to know that,

even when handled by an expert, few cars of this kind will lap Brooklands track at much above 56 miles per hour.

At Brooklands they have accurately surveyed mile-posts at quarter-mile intervals round the track. By the aid of these, a good stop-watch, and the 'Brooklands Speed and Distance Tables', we check the speedometer at speeds of 20, 30, 40, 50, and as many more miles per hour as the vehicle is capable of. It is not safe to assume that because the instrument is 2 miles per hour fast at 20 and 3 at 30 it must be 4 at 40. Generally speaking the error becomes greater with increases in speed. The worst example that I have ever discovered indicated 70 miles per hour when the actual pace was 59 miles per hour.

So far an hour or so will have been spent and the real testing has not yet started. The first figures that are obtained are the maximum speeds in the lower gears. The car is run up until the valves just commence to rattle, and that pace is noted. The highest pace at which the engine seems happy and at which gear changes up and down can be made by an expert are also ascertained.

Next follows the acceleration times from a speed of 10 to 30 miles per hour in each gear, providing that a pace as low as 10 miles per hour or as high as 30 miles per hour can be reached in that gear. Few low-power saloons will attain 30 miles per hour on bottom gear and, on the other hand, some sports cars will not run as slowly as 10 miles per hour on top.

So far the work has all been somewhat technical and, to the non-mechanically minded person, it would appear rather boring—but the following stages are more exciting. Each car is checked for slow running on top and third gear as a matter of routine, although on a sports car good top slow running is not called for. It may, in fact, indicate that the designer could with advantage raise both the gear and the compression ratio. On cars intended to be driven largely in towns by people of limited driving ability good top-gear slow running is a looked-for virtue. The most amazing automobile in this respect that I ever tested was the American twelve-cylinder Lincoln. One could step out of the car, walk beside it, and re-enter the driving seat while it was running.

Now comes one of the most thrilling parts of the procedure, the tests to find the acceleration from rest to 30, 50, and, if the car will do it, 60 miles per hour. It is an exacting trial, for the engine is speeded up to its maximum before the clutch is engaged and there is no time for any finesse in gear

changing. On many cars the clutches start to smell and show signs of slipping at the pick-up after the third or fourth attempt. Even on the smallest vehicles the sensation of power as the machine gathers speed is exhilarating but on the large sports cars it is breath-taking.

During the early part of 1939 I tested the following cars which might be regarded as typical of popular-priced saloons. The then new Austin 8 took 29.2 seconds to reach 50 miles per hour from rest, using all four gears. The corresponding time on the Wolseley Ten was 21.8 seconds, and on the Vauxhall Twelve-Four 18.8 seconds, the last-named being an unusually good figure for a 12 h.p. saloon. Of this trio only one, the Wolseley, was tested up to 60 miles per hour, and the time taken to reach this speed was 36 seconds. The reason was that the Austin's maximum was below 60, while the Vauxhall's was so little above it that no decisive figure could be taken.

Now, by way of contrast, let us examine the figures of three sports two-seaters. All were cars of high price which have done well in competitive events. In every case it was only necessary to use the bottom two gears to reach a speed of 50 miles per hour, and, even in the test to 60 miles per hour, top gear was not engaged. All these cars, by the way, can beat 90 miles per hour by a comfortable margin, and the acceleration tests were thrills never to be forgotten. The ugly but scientifically streamlined 15/98 Aston Martin took 9 seconds to reach 50 and 14 seconds to attain 60. The 3½ litre S.S. 100 reached the 50 mark in 7.8 seconds and the 60 figure in 10.6 seconds. The corresponding times for the Model 52 B.M.W. were 10.8 and 15.8 seconds.

Among sporting cars, as distinct from the out-and-out sports cars mentioned above, the Railton Saloon has a wonderful reputation. It reached 50 in the amazingly good time of 9.8 seconds and 60 in 13 seconds.

We now pass on to the maximum speed tests which, with the passing of years, I am regarding with less and less relish. I know that there are many motorists who boast of having touched 90, but what they THINK is that speed and the Railway Straight half-mile officially timed as 20 seconds are very, very different things. You take a lap in which to gather speed, and by the time the Vickers Sheds have been passed, a mile and a half farther on, your actual pace is over 90. Climbing up on to the beginning of the Members' Banking, the car slows visibly. You can feel it slowing as the needle drops back to 85, but it rapidly gathers speed again and, by the

time the Members' Bridge is reached, it has crept up to beyond the 94 mark and your actual speed is well above the 90.

The windscreen is folded flat and you crouch for shelter below the scuttle. Luckily you have had the sense to wear rubber-edged flying goggles, for ordinary motor-cycle goggles are useless at this pace. To your right you catch sight, out of the corner of your eye, of the retaining wall at the top of the banking, now as near as ten feet. As you watch it you realize that you really are moving quickly.

Below you, to your left, is the junction of the Home Straight and the Railway Straight and, from your position high up on the banking, the view is similar to the one that you get of an aerodrome as the plane circles in to land. The big sports car rides hard on its stiff suspension. There is something very reassuring and solid about its motion.

Now we approach the down grade where the banking joins the straight. The needle of the chronometric speedometer jerks upwards with the decisive motion of its kind. Chronometric instruments are very expensive and more accurate than ordinary speedometers; hence they are fitted only to very fast cars of high price. Ninety-eight, 102, 104, 106, the needle jerks forward. At this moment we are actually travelling in excess of 100 miles per hour, but it does not count, for it is purely a momentary figure and, moreover, we are on a definite down grade.

There is a bump on the bridge over the River Wey and one must take it squarely. The wheels strike it with a jolt that drives you down into your seat. We are on the flat now and the speed drops a little.

To our right is the timing-box, and across the track the white and black line that marks the beginning of the timing area. The half-kilometre post blurs past, followed almost immediately by the half-mile post. Gently you take your foot off the accelerator pedal and allow the car to lose speed. You do not slide it off sideways suddenly and, most emphatically, you do not put your foot on the brake pedal—that is if you place any value on your life.

'Eighteen point eight seconds', your mechanic announces, checking his two stop-watches. Ninety-five point seven four miles per hour. Not quite up to standard for a car that the makers hope to announce as a hundred-miles-per-hour model. So we try again and again, each test adding two and three-quarter miles to our mounting total. Once she turns the half-mile at 97·83 and once at 96·77, but the magic hundred eludes us. A little more

pep will have to be put into that engine or some streamline refinements built into the body before the hundred figure is reached.

My mechanic, new to the job, has not taken the precaution of putting a little lanoline on his face, and I see him feeling his burning cheeks ruefully.

We have now got about half-way through our work on the track. We have collected some figures and driven some 80 miles on Brooklands at speeds varying from walking pace to something in the region of 100 miles per hour.

Before taking a hurried snack of sandwiches and coffee we give the car a brief examination, feeling the brake drums and tyres for any untoward temperature rises.

Over our meal we discuss the cars that we have tested, the things that we have admired and found wanting, our thrills and narrow escapes.

I once had a shock-absorber break on me while driving on Brooklands in the rain at 70 miles per hour, and the resultant skid was the longest in the history of the track from which the car and its crew emerged unscathed. One of my colleagues had the trying experience of a tyre shedding its tread at over 80 miles an hour. Another had a propeller shaft break and hit the ground, causing the car to capsize, fortunately at slow speed. I once had a bird fly into my car during a speed test. Luckily it hit the radiator. I dread to think what would have happened if it had struck the windscreen.

A friend endeavouring to get 100 miles per hour out of a sports car had a bonnet clip break and the side of the bonnet lift. With great presence of mind he brought the car to rest before any serious damage was done.

In the main the job is safe enough, but things do occasionally happen, and if they happen during the speed test, you have not much time to do anything about it.

Our hasty snack over, the car is checked for petrol, oil, and water. As the engine is still warm we can start work at once and, by way of limbering up, we do the steering test. The car is driven briskly round the track and, as it is a sports machine capable of nearly 100 miles per hour, its steering qualities must be above suspicion. Our testing, so far, has already given us a high regard for the steering qualities and we feel that the car will acquit itself in this exacting test with honour.

If a chassis steering is perfect it will find and hold its correct place on

the banking without the necessity for touching the steering wheel. I set the car at the bottom of the banking, travelling at 70 miles per hour, my hands just above the rim of the steering-wheel, ready to grab it in case of need. Slowly the car swings to the right, a good sign, for she is climbing up the banking. As she gains altitude she slowly veers to the left, holding her place half-way up the banking. I ease my foot off the accelerator allowing the speed to drop to 50, and the car obediently noses down the banking. On the next lap the test is repeated at varying speeds, but the machine continues to place itself correctly on the banking.

Back on the Home Straight, the steering-wheel is pulled as far as it can be to the right, and a white mark is placed on the rim. Then the vehicle is set into motion and the wheel is swung as far as is possible to the left, the number of revolutions being counted. Two and a half turns of the steering-wheel are necessary to pull the car from one full lock to the other.

The lady driver or the weakling used to slow travel in congested streets might complain that this steering was too high geared and heavy on corners. The sportsman would, however, love its directness, especially at speed, and it was for speed and sportsmen that it was devised.

Next we have to measure the lock—that is, the diameter of the circle in which the car will turn. The smaller it is the easier will be the vehicle to manoeuvre in the close confines of a crowded garage or on the hairpin turns of a mountain pass. It is curious that on no car is the lock exactly the same in both directions. After mature reflection we marked the test card 'As good as the best'.

Brake test followed in the special braking area in front of the Paddock, where the rough concrete surface shows the brakes to their best advantage. The car is tested at least half a dozen times to get a true average reading and to discover any evidence of brake fade, for some brakes seem to lose a little of their bite after they have become hot with repeated applications. The stopping mechanism is always tested at exactly 30 miles per hour.

In these days of specialist design four-wheel braking systems, all cars are satisfactory in this respect, at least when they are in good condition and properly adjusted, but some are naturally better than others. A cheap car will usually pull up in 34 feet, while some of the high-grade sports cars will come to rest in less than 30 feet. Price, however, is not a good criterion on which to base braking power, for the 1939 Ford Eight is one of the half-dozen best-braked automobiles in this country.

Those who have never been in an official braking test have no conception of the enormous power of some modern car brakes when determinedly handled. Unless one braces one's arms against the scuttle one is liable to be thrown violently against the windscreen and be hurt. I have known men to be violently sick after half a dozen tests of this kind.

Next follows a combined braking and stability test, now always conducted at a modest pace in the region of 25 to 30 miles per hour.

There are many cars that pull up in a satisfactory distance but which, nevertheless, exhibit some unpleasant braking characteristics. Some tend to swing to one side, either because one brake comes into action before its fellows or because of some frame weakness. Others are inclined to roll at the moment of brake application. These characteristics will cause skidding and may be dangerous if the steering wheel is swung hard over in a moment of panic while the brakes are being applied with full force.

Accordingly the car is driven down the middle of the Home Straight at about 25 miles per hour and, with the driver releasing his hold of the steering-wheel, the brakes are applied with full force. If there is no roll, the steering-wheel does not kick, or the car slew, the braking stability may be regarded as O.K.

Setting the vehicle in a sharp curve, the speed is gradually increased and any tendency to capsize is noted. Cars vary very greatly in this respect, some of the low-slung sports models having such stiff suspensions that they will slide bodily sideways before exhibiting any desire to turn over. Curiously enough, however, too great a degree of stability is undesirable in a family saloon, for it is usually accompanied by excessive rigidity which causes the car to jar and the riding to become harsh on a rough road.

Most motorists tend to exaggerate the severity of their favourite test hill, but Brooklands is lucky in possessing a Test Hill with accurately surveyed gradients, the upper sections of which are 1 in 4 and 1 in 5 respectively. The model is driven on to the 1 in 4 section and the hand brake applied. On many automobiles of current design the brake will hold the car on this gradient, but there are some notable exceptions. If the hand lever will not hold the car on the 1 in 5 the braking system gets a black mark.

From the 1 in 4 section a start must be made from rest, which puts a severe strain on the clutch and transmission. There are still too many cars the clutches of which exhibit a distinct tendency to overheat and smell badly and which judder excessively in the transmission when put to these

tests. Almost without exception all the cheap three-speed cars are too highly geared on bottom to start easily on a hill of such severity. Motorists who own four-speed cars, the bottom gears of which are so low that they can get away in second gear on the flat, may wonder what their first ratios are for. A test of this kind will demonstrate in an unmistakable fashion.

Having once been stopped while descending the steepest part of Porlock by a motorist who had stalled his saloon while ascending and been compelled to reverse up the grade to get clear, I subject all cars to a reversing trial on the 1 in 4 section; this includes a test of the hand brake.

Although there are a few straight deserted stretches of road on which one can travel a few miles at a fairly brisk average pace, the fact remains that it is almost impossible to drive on any highway in Great Britain for more than a couple of miles with the accelerator hard down all the time on a vehicle capable of exceeding 60 miles per hour. Therefore any car that can do two complete laps of Brooklands, $5\frac{1}{2}$ miles, flat out without any tiredness on the part of the engine, excessive oil consumption, or water boiling, may be regarded as safe for use on British roads.

The next test, which follows immediately, may involve 2 to 6 laps, depending on the speed of the car. It is concerned with the discovery of the cruising speed. Every automobile has one pace at which it will hum along happily. Below that speed the driver feels that he is holding it in check all the time, and above it the car must really be driven. Most 8 h.p. saloons settle down to round about 45 miles per hour, and most of the twelves at 50 to 55. On these popular types of cars this optimum pace is rapidly ascertained.

Some of the crack continental sports machines designed for the fast European motor roads present difficulties, for they cruise at a pace that cannot be held for sufficiently long on British roads to allow the tester to pass judgement. I have joyous memories of a wonderful French Grand Sport Hotchkiss which hummed away happily a distance of rather more than 8 miles at a timed average speed of above 76 miles per hour on a gentle throttle opening.

Our work on the track has ended. Now follows a main road drive of from 40 to 100 miles, depending on the type of car. A night run of similar length tells us all that we wish to know about the power of the headlamps and the battery's ability to maintain charge, while a few miles in the traffic of London's West End reveals the vehicle's traffic manners.

**THE
CREDIT
FOR
IT**
by
**GUNBY
HADATH**



I

WHOSE was the credit for it? Should the credit go to Arthur Jeans? Or to Mr. Langforth? Or did it belong to Shapcott himself? Those who read this plain narrative must judge.

'Pass it, man! Pass!'

From the touch-line there was little distinguishable except a mix-up of bodies close to the goal-posts, nor had anything been audible for a space save panting breath and the dulled thud of feet. But now above the mêlée this shrill call rang out—'Pass it, man! Pass!'

And how on earth could a man pass with the other side surrounding him, grabbing him, clutching him? And why on earth should he, being almost beneath his own posts?

Yet the danger was that the ball would be snatched from his hands and carried or dribbled across the line in a rush!

'Fall on it, can't you!'

He couldn't.

Then the prior shrill call rang again. 'Pass it, man! Pass!' It battered at the ears of the boy with the ball, so that in his desperation he flung that ball from him with barely a turn of the head in the shouter's direction. But the one who had shouted caught it, though himself surrounded, and he side-stepped, though the crowd thought to see him pulled down. For he

was so hemmed in. The whole of his enemies were up. There was no room for him to round them. Nor to break through them. No room to sprint. No time to get into his stride. No gap to penetrate.

Or so the crowd thought.

But he might just manage to kick the ball into touch.

And that would relieve the siege for a moment at any rate.

Yes, he had dodged again, dodged inward, was poised on his left leg, with his right leg swinging round for a punt into touch. The arms of his opponent immediately confronting him which would have had him round the waist in another split second instinctively flung themselves up to charge down the kick. But the kick was not made. The other had dropped to both feet again, and with a toss of his head and a twist of his body was off.

But he wouldn't get far. The outsides were converging upon him, and none of his own men had breath enough left to support him. Not one there was who had come racing up for his pass, for not one there was who could manage more than a trot. Yet on he rushed and, swerving, avoided the next tackle, and the half-way line was crossed, and his speed had not faltered.

'How fresh the lad must be, Traill! How fresh he must be!'

A young man with glowing eyes and keen eager features had broken the silence of excitement chaining his tongue.

His companion, an elderly man, came out of his thoughts. Queer thoughts they might have seemed in such a tense moment. For he was thinking that grey as he had grown in the Grammar School's service, and many as the thrilling games he had witnessed, he had never watched one in company so enthusiastic as that of their boyish and brand-new Head-master beside him.

'Yes,' he answered laconically.

'What's his name, Traill?'

'It's Shapcott, sir.'

'Look! He's through. He'll be right through! Oh, splendid!'

And through Shapcott was. He had steamed right through, to the full-back, when, with another convulsive toss of that loose lock of hair of his, and discarding his prior devices of jinking and swerving, he had flashed forth his arm and thrust the man out of his way, then had galloped on, over the line, and grounded the ball.

From end to end the field should have rung with the school's cheering.

But there wasn't much cheering.

The Head exclaimed, 'Jolly good try, Traill!'

He was reflecting, as he presently took himself off, that, assuming the form of this afternoon's trial was true, the school could put up a useful game of Rigger for its size, albeit, from all he had heard, it had never distinguished itself at work or at play nor won any laurels worth mentioning out in the world. And might he not take this game for an omen, he felt. For that was his job: to lift the school out of the rut; for that he had come, with his own honours fresh upon him. 'New brooms sweep clean'—oh, yes, he knew all about that. Then the boyish face allowed itself a broad smile. But after the smile came a hardening of the firm lips, as Arthur Jeans vowed to make his ambition good.

January passed. Arrived February, sullen with rain. Then one afternoon when the sun had come out for a change, Mr. Jeans emerged from his own quarters into the school's, to fetch a book he had left behind in his classroom.

It was very quiet indoors. There were no signs of any one. They were all of them making the most of the change in the weather. But as soon as he entered the classroom, he saw a solitary figure at one of the desks with its back to him.

He crossed the room. But the boy whose head was bent over the desk did not rise.

In some astonishment Mr. Jeans advanced to the desk. 'You!' he ejaculated. 'You, Shapcott! What are you doing? Didn't you hear me?'

Then Shapcott looked up. But his eyes were not seeing the Head's eyes. They were looking for something a long way off, searching for something, they were in a dream with a black frown suspended above them.

'Oh, please!' he muttered resentfully.

'I'm disturbing you, am I?' said Mr. Jeans with a smile, as he noticed now a pencil in the boy's hand and a sheet of paper covered with figures beneath it.

'I'd almost got it,' Shapcott muttered again.

'Let me see it, please.'

'No! Wait till I've got it,' growled Shapcott, in so much absorption that he seemed to be unconscious to whom he was speaking. Then down dropped his head again, and off went his pencil, while Mr. Jeans, holding

his breath, looked over his shoulder. And Mr. Jeans had reason for holding his breath. For the boy was working at a problem in higher mathematics which ought to have been immeasurably beyond his reach. Which ought to have been—by every recognized standard.

'Got it!' he exclaimed, his clouded face lifting as he crossed some figures out and dashed down some others. 'There! Isn't that right!' He seemed to come out of himself, and began to breathe heavily.

Mr. Jeans sat down beside him and studied his figures. Then, 'I'll keep these, if you don't mind, Shapcott,' said he. 'Oh, and by the way, you are due to leave in July, aren't you? Did you ever think of trying for a Maths schol. at one of the Universities?' He had made his voice very casual.

'There's no one here who can teach Maths,' Shapcott said surlily.

Returning no answer, the Head jumped up and went for his book. With this under his arm he departed, but not to his own quarters. Instead, he went fast to the study of old Mr. Traill. And, 'Traill,' he burst out, in great eagerness, 'did you know we were harbouring a genius?'

'I did not,' rejoined the old gentleman, dryly and formally.

'I mean it, man! I mean it!' cried Mr. Jeans, and tremendously boyish he looked in his pulsing excitement. 'We have a mathematical genius in this school! There's not a master among us, I bet you, who could

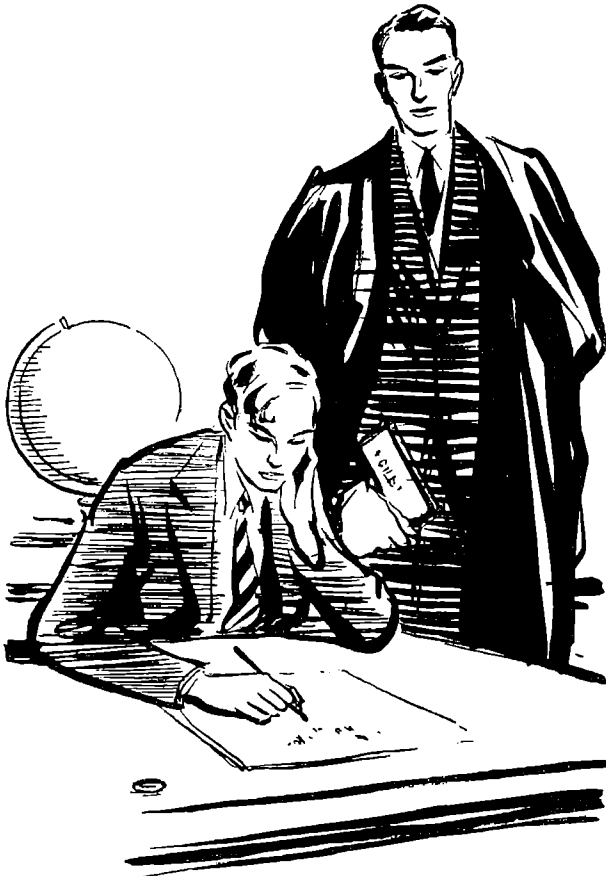

Mr. Jeans, holding his breath, looked over his shoulder

teach him anything.' And tremendously boyish his words sounded to Mr. Traill.

'So the phenomenon is a boy, is he, sir?'

'The phenomenon, as you properly term him, is Shapcott.'

Then Mr. Jeans stared at his colleague to mark the effect. But instead of a spark of fire in those wise old eyes he saw only a shadow.

'You're not thrilled. You ought to be thrilled. We've got the Hyde-Parkinson scholarship in our pocket!'

'The Hyde-Parkinson Maths schol.?' said Mr. Traill, raising his eyebrows.

'It's as good as that, yes, Traill. The Hyde-Parkinson schol. at St. George's, Cambridge. The plum of all the schols. for Maths in the kingdom. And Shapcott will win it. What honour at last for this Grammar School! We'll be on the map; we'll be right on the map at long last, Traill!'

Thus Mr. Jeans exulting, shooting his words forth. But they found an unreceptive target in Traill. And so forced was the tone of his tardy congratulations, that finally Mr. Jeans taxed him.

And out came the truth.

Shapcott, he revealed, was thoroughly unpopular. 'You remember that brilliant try of his the other day, sir? You commented yourself on the lukewarm applause.'

'I remember,' the Head said.

'That try illustrated Shapcott, if I may put it so. Instead of pulling his weight, as the others had done, he'd been slacking all through the game, he'd been saving himself up to do something spectacular. You remarked yourself, sir, how fresh he appeared. That's the reason.'

'I remember,' repeated the Head.

'So the fellows wouldn't applaud his try; not to spite him, but because he'd been obviously letting his side down till then. And that's Shapcott all over. In every way. No one makes friends with him.'

'You have either told me too much or too little,' the Head said.

Mr. Traill drew a sigh. 'You compel me to say more,' he said gravely. 'You haven't been here long enough, sir, to learn Shapcott's character. But all of us on the staff know it. And so do the boys. He's a lad of bad character and of bad influence who would do the school no credit at the University.'

'Is that so?'

'It is so. For my own part, I'm sorry to say, I should be unable to sign a certificate of character for Shapcott.'

'Ah!' uttered Mr. Jeans sharply. 'But if that is the case, Traill, why ever didn't my predecessor get rid of him?'

'Mr. Harbard was always too lenient.'

'In your personal opinion!'

The stress on the 'personal' nettled the veteran's feelings. 'In Mr. Harbard's own opinion as well,' he retorted with a stiffness very unusual. 'I was always in his confidence, let me tell you, and shortly before he resigned he told me that had he been staying he wouldn't have kept Shapcott. May I give you his words? "A young man is following me," he said, "a very young man. And he'll stand no nonsense with Shapcott."'

'So you seriously warn me that Shapcott is a bad egg?'

'I'm afraid that I must, sir.'

'Altogether too bad an egg, in fact, to send up for a scholarship?'

The veteran's troubled silence gave its assent.

II

So at the very onset of his Headmastership, which he had taken up with so much burning enthusiasm, Mr. Jeans found himself with a difficult nut to crack. He had to consider his duty to the school's Governors, his duty to the school, his duty to himself, and his duty to Shapcott. How to reconcile these?

And what was to become of his secret ambitions?

It worried him. He was raw, he felt, lacking experience. But his nettle had to be grasped, and the sooner, the better. So, after checking Shapcott's reports from his very first term onwards, and after very patient and quiet inquiries which went to confirm Traill, he summoned Shapcott himself and came straight to the point. 'Shapcott,' he said, 'is it true that you're not very popular?'

'Who cares for that, sir!' said Shapcott, with a bold leer.

(So that's the sort of boy you are, thought Mr. Jeans.)

'Shapcott, during my few weeks here, I have seen nothing to find fault with at all in your conduct. But tell me: if my predecessor, Mr. Harbard, had been called upon to give you a character, would he have been able to give you a good one?'

'He wouldn't. He'd have spited me,' Shapcott said viciously.

(So that *is* the sort of boy you are, thought Mr. Jeans.)

'Well, Shapcott,' he proceeded, 'let's turn to your Maths. You have consistently been top of your set in that subject. But I can't ascertain that you've ever done more than you were asked for.'

'Why should I?' said Shapcott curtly, and leering again. 'I've always been a long way ahead of the work in class, but if I'd let that out to the masters they'd only have bothered me.'

'That sounds strange, Shapcott.'

'A chap can do what he likes, sir.'

'Oh, can he? Still, as your aptitude's never been guessed your explanation seems credible. So you've worked up your Maths for your own satisfaction entirely?'

'It's fun, sir,' said Shapcott, speaking naturally for the first time.

(So now you're revealing your other side, thought Mr. Jeans.)

He studied the boy in perplexity. 'Shapcott,' he said next, 'it happens that I was a Cambridge wrangler myself, and accordingly I know what I'm talking about. Your Maths would win you a scholarship at the University.' And he went on to tell of the famous Hyde-Parkinson scholarship. 'But am I justified,' he inquired, 'in entering you for it?'

'Why shouldn't you?' mumbled Shapcott.

'Because of your character. I should have to lodge a certificate of your good character. And from all accounts, I'm afraid I could hardly do that.'

'You might manage it, at a pinch, sir,' said Shapcott ungraciously. An uncouth creature. Yes, and with abominable manners.

But shrewd, very shrewd. 'Besides, sir, you say all the celebrated schools have shots at that schol. So what a feather in this potty school's cap if I win it!'

'Shame on you for speaking like that of your school!'

With a shrug of his heavy shoulders, Shapcott passed that. 'And what an honour for you if I win it, sir!' he continued.

Mr. Jeans pulled him up. 'You can leave that out,' he said sharply. 'In your case my personal feelings are not to the point and I shall not allow them to influence my decision. The point is, Shapcott, that it wouldn't do this school any good to send a boy of no character into the limelight. And mark this, Shapcott. The fellow who wins the Hyde-Parkinson is going to be very much in the limelight among the authorities of his College and so forth.'

Shapcott scowled, but said nothing.

Then Mr. Jeans laid down his terms.

If Shapcott gave no trouble between now and then, in June he should go up to Cambridge to sit for the scholarship. In any event, he was due to leave in July. So if he continued to give no trouble before then, in exchange he should receive the conduct certificate which would qualify him to take up the schol. if he had won it.

‘Does one hear before July, sir?’ Shapcott put in.

‘Yes. The result is announced before the schools break up, in order to enable the winner to make his arrangements for Cambridge.’

‘Where he’ll go in October?’

‘Yes, Shapcott.’

Then Mr. Jeans rose to his feet. ‘And listen!’ he said. ‘I’m game to help you every bit that I can. I’ll give you as much of my private time as you want. Does that go with you? Do we pull together, old man?’

He had spoken simply, throwing off the Headmaster. He wanted to get inside this queer creature’s shell. But, except for a bare word of thanks, Shapcott showed no acknowledgement. So when he came away, he left Mr. Jeans wondering. For although he had done his best to overcome prejudice, he couldn’t pretend to himself that he found the chap likeable. . . .

Still, Shapcott was in a class by himself so far as mathematics were concerned. And many such men who’d contributed to man’s progress had exhibited a sour face to the world. So one couldn’t have it every way, he supposed; your genius couldn’t be measured by ordinary conventions. Accordingly one might make some allowance for Shapcott. . . .

At these cross-roads of his reflections, Mr. Jeans halted. ‘Come! We’re growing a little too abstract!’ he told himself, smiling. ‘And, genius or no genius, unless Shapcott watches his step, he’ll wangle no certificate out of me.’

And he laughed his free, boyish laugh.

III

It appears, however, that Shapcott had watched his step. For here he was with the Head on this Monday, the second of June, within an hour of taking the train to sit for the schol. He looked in the highest of spirits, and supremely confident. As he tossed back his loose lock of hair from over his forehead (how Mr. Jeans always wished that the fellow would have that

lock shorn!) he chuckled and said, 'When I slogged till my eyes ached, for fun, sir, I never imagined I was earning three years at Cambridge!'

'You're not there yet,' he was warned.

'As good as,' grinned Shapcott; 'as good as! But I wanted to ask you, sir: I'm to stay in one of the College's lodging-houses while the exam. is on. Do they charge me for that?'

'For your lodging? Oh no! You're their guest for to-night and to-morrow night. Then on Wednesday, the second day of the exam., you will finish at four o'clock; which will give you plenty of time to catch the train back.'

'That's fine, sir,' said Shapcott. 'But instead of coming straight back here on Wednesday, may I go on to Histon and spend the night with some cousins there?'

'Yes, certainly. Then report to me Thursday midday. And mind you, Shapcott,' smiled Mr. Jeans, shaking his hand, 'the next time I see you standing here in my study I can vision the goddess of Victory standing beside you!'

'Trust me, sir,' said Shapcott.

His confidence accompanied him in the train, strode along with him to his lodging in the Petty Cury, shared his evening meal with him, and saw him to bed. And next morning at a quarter to ten to the tick it stood arm-in-arm with him in the panelled Hall of St. George's where the candidates assembled for roll. There were twenty-seven of them, and each, after answering his name, was conducted by the usher to his place at the long, polished tables, where he seated himself in front of writing-materials to wait for the distribution of the printed paper.

This waiting, these formalities, might have unnerved some, but Shapcott's heart was beating as steadily as ever when at five to ten two dons in their gowns arrived gravely and passed along the tables with their dread documents. Then these two went, and the College Tutor himself came; and, as the final stroke of the hour was sounding outside, he gave sign—and another Hyde-Parkinson had begun.

Some had pounced on the paper avidly, some of them anxiously; but to Shapcott it was only 'rather good fun', as he stated, after they'd come out at twelve o'clock, when reporting how he'd got on to Gorman and Creak. These were two of the Grammar School Old Boys, who had sought him out as soon as they'd seen on the list posted outside the Senate House that their

old school was sending a candidate. Creak slapped him on the back. 'You're a great lad!' said he. 'Who'd ever have dreamed of our jolly old show going in for the Hykers!'

'So that's what you call it!' drawled Shapcott. 'Well, between you and me, I found this morning's paper quite elementary.'

They laughed. 'Now you're pulling our legs. But go on and prosper.'

'And, by James,' added Creak, 'if you win, we'll show you round, Shapcott!'

'Right! That's a promise!' grinned Shapcott.

At two o'clock the candidates reassembled. At four they came out again, a few of them looking depressed and others looking tired. Next morning three were missing. That told its tale. They had butchered yesterday's papers and thrown up the sponge.

But on sailed Shapcott through the smoothest of waters. And at four o'clock as his work was collected and he stuffed the questions into his pocket, he knew that he had hardly dropped a mark. And now to pack up and get off to his cousins at Histon. But should he not say good-bye first to Gorman and Creak?

So, his suit-case in hand, he went to St. Jude's, and found them just back from the river and brewing some tea. 'Well? How have you finished up, Shapcott?'

'No complaints,' he said merrily.

'That's splendid! Have some tea.' Creak brought out a third cup, and pouring the tea out, asked 'Going straight back?'

'No, I'm spending the night at Histon.'

'Still splendid!' Creak said, and, as he set down the tea-pot, he glanced at his friend. Gorman nodded in reply; then said, 'Shapcott, my hearty, you've any amount of time to get on to Histon. So Creak and I are going to show you round first!'

Oh, grand, to be shown round the town by two 'Varsity bloods! Hang Histon. Histon could wait! 'You'll feed with us first, Shapcott. Creak, where shall we stagger for a mouthful of fodder?'

'What about Attiani's?'

'A bit risky, isn't it?'

'Bosh! There's no need to be spotted.'

So, after Shapcott's suit-case had been deposited at the station, a private room in Attiani's it was. And then where? Well, for all that *he* cared,

laughed Shapcott, wherever it might be, it wasn't Histon just yet. So Rod Royal's Band in the Assembly Rooms appeared indicated. They would leave their caps and gowns outside in the car park, for, as Creak explained to their guest, undergrads weren't allowed there.

'But you're all right, Shapcott. You're not an undergrad yet!'

Shapcott laughed his high scoffing laugh. 'If I was,' he protested, 'it wouldn't make any difference. You don't imagine I'd funk any mouldy old proctors!'

'Not you, old sport!' applauded Gorman. 'Come on, then!'

The band was great, the dancing top-hole, Shapcott thought. At ten o'clock, having missed his last train to Histon, he would have to try to scrounge a car, he supposed. 'I doubt if you'll get a car to-night,' Creak was telling him, when a whisper went through the throng like the rustle of wind, to be followed by an immediate bolt to the cloak-rooms. There were only townees left on the floor when the proctor appeared.

There he stood, with his 'bulldogs' behind him, framed in the doorway, a stocky man, black-bearded, with square, thrusting jaw. Stay! Were the revellers only townees, or were those three young fellows, one of them with a gay paper cap on his head, who were crouching behind the bandstand, were they undergraduates?

Mr. Langforth sent one of his bulldogs. The man came back with the three.

'Your name and College?'

'Gorman, sir, of St. Jude's.'

'Report to me at St. George's at ten o'clock in the morning.'

'And your name and College?'

'Creak, of St. Jude's, sir.'

'Report with your friend.'

Shapcott had not snatched off his paper cap. *He* didn't belong to the 'Varsity! He'd show these chaps that he didn't funk their old proctors! 'And you? Your name?' He returned an impudent grin. 'My name has nothing to do with you. It's my business!' Oh, tremendous! What a dog his companions would think him!

Mr. Langforth rejoined, 'So you're not at the University?'

He spoke very quietly, while Gorman and Creak were doing their best to warn Shapcott. They dared not interrupt, but their glances said, 'Stop it, you fool!' But Shapcott and his folly were not to be parted. 'No, I'm

not,' he answered, fleeing, 'and you can't touch me. You can put it across these other two chaps, but you can't touch me!'

One wonders whether he had actually heard Mr. Langforth telling Gorman and Creak to report to him *at St. George's*? Or had his mind been too busy preparing his braggadocio?

Mr. Langforth's eyes grew hard as steel, but his voice did not rise. 'I have no jurisdiction over you,' he responded. 'But before I let you go I must know where you live. Do you live in Cambridge?'

'I don't.'

'You're at school, are you? Where?'

'That isn't your business.'

'I am sorry, but I must make it my business,' said Langforth. 'And incidentally, when you address me, say "sir". And take that ridiculous paper cap off your head.'

Shapcott should have climbed down then and apologized. Gorman's agonized glance implored him. Creak's arm nudged his elbow. But instead he tossed his head and would have marched off if the bulldogs had not been too quick for him.

'And now. Your name and the name of your school?' he was bidden.

He gave both with a surly defiance.

'And what are you doing in Cambridge?'

'I am up for a schol.,' he said sullenly.

'What scholarship!'

'The Hyde-Parkinson—if you want to know.'

This was flung out into Langforth's face like a stone.

The proctor waited a moment. Then, with his eyes dwelling coldly on Shapcott, he said, 'Well, it happens that Mr. Jeans and I are old friends. And you may be sure that I shall certainly lose no time in writing to inform him how his pupils behave when they come as the guests of my College to sit for our scholarships.' He paused. 'That is all. You can go.'

IV

After parting from Gorman and Creak and recovering his suit-case, he knocked up the people at his lodging, and, his temper still very hot, he went to bed fuming. But at four o'clock he woke up with a start—to the truth.

And then how gladly he would have given all he possessed to go to sleep again and wake up and find that he'd dreamed it all!



'And now, your name and the name of your school?'

But he couldn't sleep any more. And it wasn't a dream. He got out of bed and, with his mind in a torment, began pacing the room. To and fro. To and fro. Then he dressed and, as soon as the light showed, he slipped from the house. He hadn't had any breakfast. He couldn't eat breakfast. Although there were few signs of life on the streets yet, his fears drove him on to St. George's, where he waited for the porter's lodge to be opened.

Restlessly he waited outside on the pavement, till he heard the key grind in the lock, saw the door swinging wide and the porter himself in the entrance. He rushed at him. 'Can I see Mr. Langforth?' he gasped.

His agitation brought a wide stare from the porter. 'Mr. Langforth has his rooms in College,' he answered, 'but resides in Queen's Road.' He added the number; and as Shapcott muttered a word of thanks and darted away, the porter stood there looking after him with pursed lips.

It was not the Shapcott who had been showing off to his friends, but a terrified and horribly miserable creature who eventually gained admission to the house in Queen's Road to throw himself upon Mr. Langforth's mercy. Nine o'clock was chiming as the parlour-maid showed him in and left him in the study, a prey to suspense. In ten minutes Mr. Langforth came. Shapcott broke down then. In stuttering words he apologized for his insolence. 'And, sir,' he confessed, 'Mr. Jeans gave me leave for the night on the understanding that I spent it with cousins at Histon. When he hears that I broke my word, I don't know what he'll do.'

Mr. Langforth smiled. Here amid his domestic surroundings he looked more human than he had looked in the trappings of office. Yet his smile was not at all a comforting smile, as he answered that Shapcott ought to have thought of that earlier.

Then Shapcott entreated him not to write to the Head.

'Indeed I shall. I have never encountered more shameful impertinence. And I hope Mr. Jeans will punish you as you deserve.'

Then out it had to pour, the tale of the sword that hung over him: the withholding of the essential certificate of character if his conduct gave any further cause for complaint.

'So you see, sir, if you report me, I'm done, sir,' he moaned.

Those blue-grey eyes, the colour of steel, did not soften as they pierced him through and through; the cold voice was pitiless. 'I shall write to your Head. You will take him the letter yourself. And after that I have washed my hands of the matter. I shall never return to it. I have done with it,

Shapcott. It is most distressing. I've done with it, understand, Shapcott, as soon as I have reported you to your Headmaster.'

He tried to plead again, but he could not move Langforth, who rose at once, and wrote his letter, and sealed it. 'Now there you are,' he bade, as he gave it to Shapcott; 'you go straight back and deliver it to your Headmaster. And that is the end so far as I am concerned,' he repeated with bitter significance.

And Shapcott took the letter, and came away.

V

Destroy it? Of course he'd destroy it. Who wouldn't destroy it! That brute had said that he'd never return to the subject, that he'd 'washed his hands' of it. All right, then! So would he. Jeans would never find out. And if Jeans did, it wouldn't be for a long time, by when he himself would be safe and sound up at Cambridge! Destroy the beastly thing. Tear it up into pieces and scatter them out of the window. . . .

Thus Shapcott, with a brow as black as the night, as his train was carrying him swiftly back to his doom.

His hand went to his breast pocket. He brought out the letter. One rip across and across, and it would be finished. 'Yes, finished and done with, my dear Mr. Langforth!' mocked Shapcott.

Forty minutes later found him with Mr. Jeans. 'Well? How have you got on, Shapcott?'

'Very well, sir!' He showed Mr. Jeans the questions. He demonstrated how he had worked out the problems. And Mr. Jeans was glowing. His spirits had soared. 'And how was Cambridge? How were your cousins at Histon?'

'I didn't see them, sir!'

'What!'

'I didn't see them.'

'But you spent last night there!'

'No, sir,' said Shapcott dejectedly. Then he brought out a letter from his breast pocket, but as he gave this letter to Mr. Jeans his hand was trembling. And his voice had broken as he said with a rush, 'It's for you, sir.'

Mr. Jeans took the letter to the window, where he broke the seal and read it.

THE CREDIT FOR IT

Dear Jeans,

It was very pleasant to hear of you again. Do you remember that July at Dittisham when I tumbled into the Dart and you fished me out?

But it wasn't quite so pleasant to hear of you via your go-between, a boy called Shapcott, whom in return I am employing as my postman. He may deliver this letter, and again he may not. Were I in his shoes I might be sadly tempted to destroy it. Because I have made it plain to him that, regarding the matter concerned, he has no more to fear from me.

You must take my point, Jeans. If this letter never comes into your hands, Shapcott can tell you any story he likes without any danger of contradiction. On the contrary, if he does deliver this letter, then he'll have to tell you how he spent yesterday evening. In that case he is convinced that you will stop him from taking up his scholarship.

So, you see, I am setting your scapegrace a stiff test. If he is past hoping for, he will suppress this letter.

But if he stands up to the test by delivering it, then I think I can assure you that we shall be glad to have him at St. George's if he wins the Hyde-Parkinson.

That will do your school some good, won't it?

Yours, G. R. Langforth.

Post Scriptum. My own feeling is that Cambridge will make a good man of him.

And Cambridge did.

So whose was the credit for it? Should the credit go to Arthur Jeans? Or to Mr. Langforth? Or to Shapcott? Those who have read this plain narrative must judge for themselves.

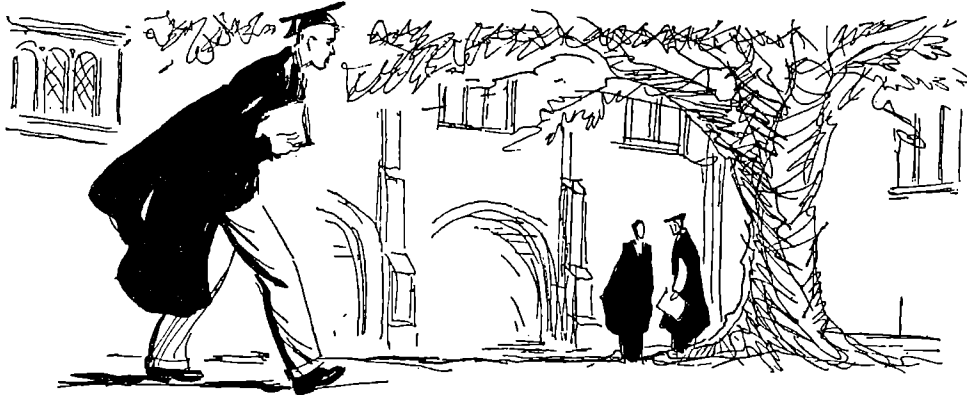

KICKING GOALS AT RUGGER

Adding those extra points

By REFEREE

IT is astonishing how many matches in Rugby Football are just won or lost by a narrow margin of points, and how, only too often, this margin is represented by the success or failure of a place or penalty kick. The writer has had experience as a player and referee for over twenty-five years and it is his belief that in ordinary Club and School matches kicking is not so successful in recent years as it was in the Rugby revival which followed the Great War. Unfortunately, statistics are not readily available except in important games such as the International or County Championships, but even in these elevated contests poor attempts at penalties and conversions are not unknown. A representative side should never take the field without several really good kickers capable of improving the hard-won try or the reasonably situated penalty. And by practice it is wonderful how the kicking of the Club and School member can be improved. It is not enough that you should say, 'This is scarcely likely to concern me because we have our regular place-kick,' for he may be absent or temporarily injured;

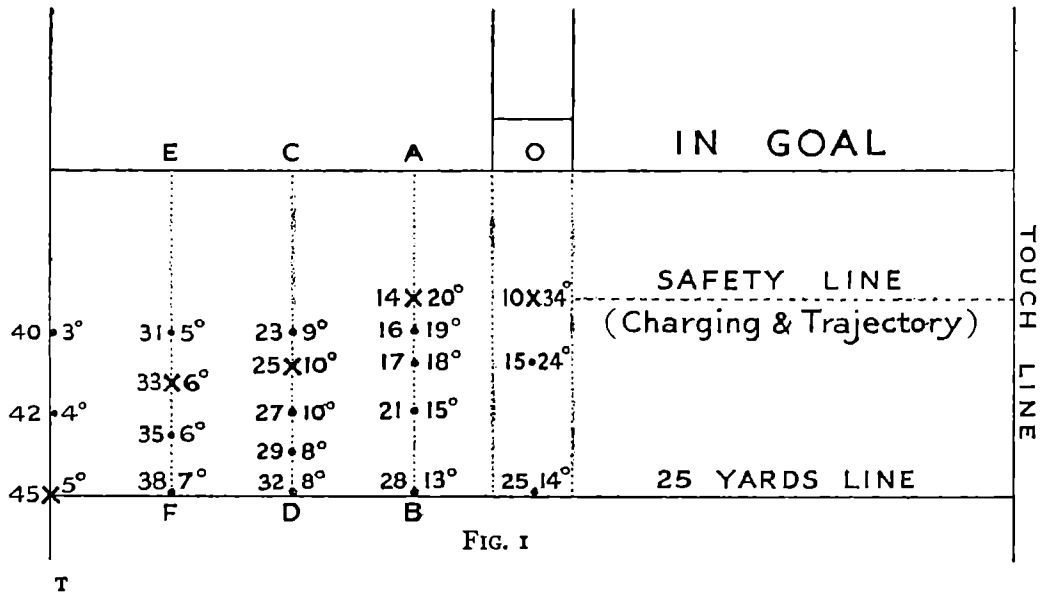

again, if you make a mark within anything like striking distance you will have to take the kick yourself, and to kick feebly to touch when there is reasonable chance of a goal may make all the difference to the result of the game.

It is the purpose of this article to discuss some of the methods by which you may develop into a useful place-kick.

On p. 145 is a diagram (Fig. 1) which will help to explain some of the points at issue. It represents a pitch 75 yards wide, and extends to the 25 yards line and part of the 'in-goal' area. A narrow lane is drawn at right-angles to the goal-posts, marking, of course, the area from which kicks are taken when a try is grounded between the posts. A, C, and E are various positions along the goal-line opposite which tries may be scored and AB, CD, and EF run at right angles to these positions. Points along these dotted lines represent possible positions for kicks. At each position is the range to the nearest yard and the angle offered by the width or face of the goal-posts. One side only is given, for identical problems occur the other side of the field.

We shall take first the easiest position, that is, when a try is scored between the posts and when conversion ought to be an absolute certainty. But let us quote the rule governing such kicks before proceeding. (It would be an excellent idea if coaches at Schools subjected the boys to periodic examinations and discussions on the rules of rugger. Boys should know them before taking part in matches.)

Law 25 (a).

The ball must be brought into the field-of-play, and be placed on the ground on a line parallel to the touch-lines through the place where the try was obtained. Any player of the team may take the kick, but the ball must not be handled by the kicker after it has been placed on the ground.

The part of the rule that I want to drive home is that the kicker comes out into the field-of-play *any distance that he pleases*. Note that he need not come back to the 25-line. It is not necessary to do so; in fact, from 10 to 15 yards out is a much easier position along the narrow lane, making assurance doubly sure, and although a goal from such direct approach should be scored even from the 25-yard line I have seen quite a number narrowly missed which would have sailed over the bar from 15 yards. Theoretically, each kick that does not land exactly between the posts has a

certain margin of error which increases with the distance the ball travels, so that it is quite possible for the 15-yard kick just to score and a similar kick from the 25-yard mark just to miss. A pulled or sliced ball increases its distance from the target each yard it travels.

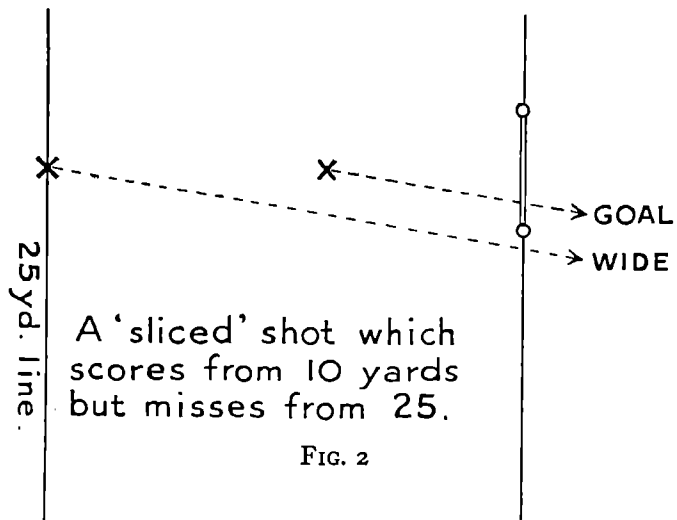

FIG. 2

From 10 yards the angle offered is 34° ; from 15 yards the angle is 24° ; from 25 yards the sector is reduced to 14° . The wider the sector the better chance of scoring, for it is obvious that the larger the angle through which you kick the more generous is the allowance for a margin of error. I am not forgetting that the ball has to be lifted to a height of 10 feet when it passes the posts, and this consideration of what is called trajectory is very important. Also we have to remember a line of eager opponents who will charge out the moment the placer has grounded the ball for the kicker. But 15 yards, or even 10 yards, is ample distance to allow sufficient rise for the ball, and the short run necessary for such a kick gets the ball away without danger from charging. Don't be afraid of a short distance. Some time ago the writer experimented with a club member and we took careful note of the angles and distances of various placings. We found it possible to kick over the bar from a spot only 5 yards in front of goal! From 10 to 15 yards, however, is the safest distance for the direct kick, and it is hardly possible to miss at a range where the goal is as wide as the proverbial barn door: moreover, there is plenty of distance for the ball to rise.

Another argument against taking the ball right back to the 25-line occurs when the elements are unfavourable, that is, when rain, wet, or mud add considerably to the regulation weight of the ball—13 to $15\frac{1}{2}$ ounces—and when the wind is likely to cause delay, slice, or pull in the flight of the shot for goal. Reduce the distance and you reduce the effect of the margin

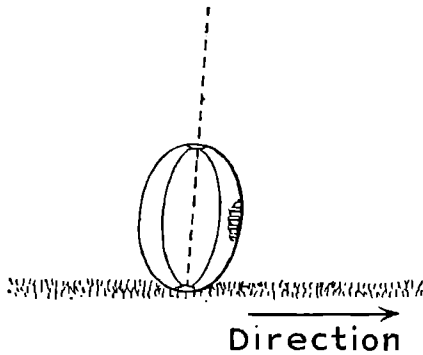

FIG. 3

of error caused by the elements. How often have I seen a heavy ball kicked from the 25-line, against the wind, and fall just below the bar or go just wide of the post! The skipper says, 'Hard luck!' when he ought to shout, 'Very thoughtless and careless shot, sir!'

Now for the actual placing and kicking of the ball. To a certain extent this is a matter for individual trial and experiment and depends upon certain factors which you must prove for your-

selves. Most players agree that for the short distance it is best to place the ball with its axis inclined very slightly from the vertical towards the goal. A side view of the ball, taken from the touch-line, would make the ball appear as it is in Fig. 3.

A long run is not essential in the approach to the ball. The kick itself supplies or imparts the actual force which propels the ball forward and upward, although with a longer shot a slightly longer run brings a gathering speed which allows of a stronger kick. This again is a matter of opinion and the keen player will experiment like the athlete practising the long jump as to the speed, stride, and distance of his approach to the ball. Then a sharp crisp kick, the toe making contact with the ball at a point about two inches from the ground. In the case of a longer distance more follow-through with body and leg is advisable owing to the longer and speedier approach, and the ball should be kicked at a point a trifle higher than for the short kick.

It is not easy to plot out the course taken by the ball in these kicks, except perhaps by ciné-camera, but in the experiments previously mentioned my colleague and I did make approximate diagrams of our efforts in the air. He was a more powerful kicker than myself, but when we came to analyse our successful shots we found a difference which was quite interesting. And in practice or training I am inclined to think that we shall derive more benefit from asking after the good shot, 'What did I do right?' than from saying, 'What went wrong?' after the unsuccessful kick. We each favoured a different trajectory, myself a comparatively high one and my friend a rather low one. After all, the style or trajectory of shot matters little so long as the goal is kicked.

Mapped out in diagram form the shots were rather like Fig. 4 as seen from the touch-line. A represents my 'howitzer' trajectory whilst B shows my friend's 'gun-like' course. After reaching its highest flight the ball loses its early impetus and drops rather more sharply. In placing the ball, my friend inclined its axis at a smaller angle than I, and generally the total length of his kick (that is, from the point of kicking to the point of dropping) was greater than mine. Yet this did not mean that he could necessarily kick goals from a greater distance. It will be appreciated that his chief concern was to make the height, whereas mine was to reach the distance. His shot sometimes

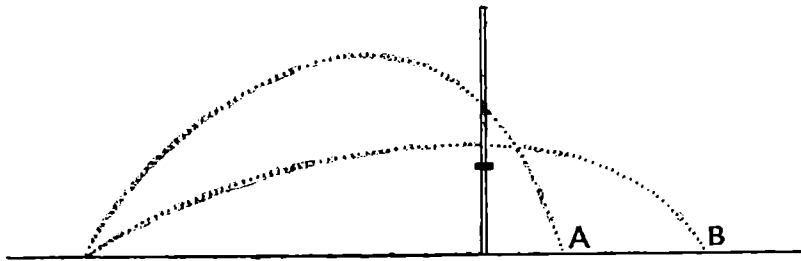

FIG. 4

made a greater distance but failed to clear the bar, whereas my shorter length would just manage to go over. Needless to add, his method on the average brought as many extra points as mine. The comparison merely seeks to indicate that length is not everything, and whereas he slightly reduced the angle of axis as the distance out increased I found that a ball near the vertical was always better for the high trajectory. The point is that we adopted methods which best suited our respective styles, studying both ordinary conversions and penalties from longer distances.

Coming now to conversions from positions not directly in front of goal the player is confronted with a more intricate problem, for he has to consider two factors, the range of the target and the size of the angle through which the kick is taken. What he requires is a point which

- (a) is safe from the charge, i.e. at least 10 yards out;
- (b) provides the shortest range;
- (c) allows of the most generous angle.

The last two factors are the principal ones since the first consideration is always constant, and the kicker will therefore endeavour to place the ball as near as possible to the goal without sacrificing too much benefit of angle.

A, C, and E are one quarter, one-half, and three-quarters respectively of the distance out from the centre O towards the touch-line and these are the positions we shall study. For a try opposite A most players bring the ball back to the 25-line, seeing that from there they view a maximum width of goal-face. Yet this distance from the posts gives a range of 28 yards and an angle of a mere 13° through which to kick, whereas a position 10 yards from A (and only 14 yards from the posts) yields an angle of 20° . How many players attempt their conversions from such an easy position?

Next we come to the half-way position opposite c. Along this line the maximum sector was found at a distance of about 15 yards from c and therefore 25 yards from the posts. Of course the angles become smaller and the kicks more difficult as we move towards the touch-line, but we shall always feel more satisfied if we make the kick from the best possible position.

Along the line EF there is little difference in the narrow angles offered for selection and the player will be concerned chiefly with the range. Incidentally the difference in this latter factor also decreases as we move towards the touch-line. Thus a range of 33 yards seems to be about the best mark along EF.

On the touch-line itself we have little choice, for anywhere along it the player has to kick through a very small angle with a range of 40 yards as a safe minimum. Such a kick is a difficult but by no means an impossible proposition and requires both strength of kick and great accuracy in direction. On a fine day with light ball and favourable conditions the player would be well advised to go back to the 25-line, a range of 45 yards, to obtain the slight advantage of angle; on a wet day with heavy ball he would do better to gain 5 yards in range, since no kick can score—however accurate in direction—unless the distance is reached. The keen player through practice and experience should be able to know his limitations of range under varying conditions, and should thus be able quickly to gauge the best point for conversion in any position under different conditions.

There are other minor factors all worthy of attention, such as care of boots, a thorough understanding with the colleague who places the ball (with the lacing away from the kick), the hole made for the ball, and allowance for the wind. The keen player will study all these matters.

To sum up, crosses have been placed on the diagram near the positions which would seem to offer the best chance of success, and all you now need is a friend, a field, and a ball to test these theories for yourselves.



A Cipher Affair

by

*Alexander
d'Alypheyeff*

I

I WAS sitting peacefully in our sitting-room at the cottage. Only the day before had the carpenter finished nailing down the floor-boards and bookshelves, and that morning Bob and I had brought in the old oak bureau and the two easy chairs from the barn, where we stored our furniture while the cottage was being rebuilt. We had made a cheerful log fire, and it was crackling in the Adam basket grate when we sat down to admire our handiwork. The new window we had put in on the south wall to get more sun, the stone surround which now replaced the old kitchen grate, and the antique gilt mirror over the fire-place which Bob had picked up at an auction, all looked very cosy. The rumours of impending war were completely alien to this place. We looked out of our windows on the peaceful field with its line of trees at the far end, and beyond the bluish Cotswold hills, basking in the glow of a setting August sun.

I felt I could now settle down to write my new book, the plan of which I had already discussed with my publishers, and I was full of eager anticipation, imagining quiet days of writing, sitting at the old bureau, with Bob pottering about with his model aeroplanes, or getting the garden ready outside. Bob and I had been through many vicissitudes in each other's company, though we had never before tried the experiment of living together. But motoring along one summer day, we had come across this

derelict cottage and decided to do it up ourselves and see what it looked like. This we had done, and on the whole were proud of our work.

I lit my pipe and looked through the other window at the leafy narrow lane that connected us with the main trunk road, full of bustling noisy traffic, which was happily a quarter of a mile away.

Rather astonishingly, a large American limousine was drawing up outside our gate, and almost before it was at a standstill a large man in a light-grey suit impatiently jumped out of it and strode up our front path. I had barely time to say: 'Bob, we have visitors,' when impatient knocking made my remark unnecessary.

Bob opened the door, which was in the next room.

'Is Mr. Rochfort in?'

'Yes. What name?'

'Eric Smith, please.'

Listening to this, I thought that I could detect a faint American accent.

I got up to meet Mr. Smith and immediately rather liked his looks.

'Are you the author of the recent book on *Codes and Ciphers*?' asked Mr. Smith with a perfunctory handshake.

I said that I was.

'You are not English, Mr. Rochfort, are you?' he continued rapidly.

'No, I am not,' I answered, wondering what he was going to ask me next.

'Then I have a business proposition to put up to you.' I asked Mr. Smith to sit down and offered him a cigarette. Business propositions to the impecunious author are the breath of life.

Bob, who had followed him in, winked at me. Mr. Smith lit his cigarette and continued rather surprisingly, 'Will you not introduce me? Does your friend live with you?'

Quite taken aback and feeling rather like a guilty schoolboy I answered, 'Er, yes, he does. Mr. Cummings—Mr. Smith.' They shook hands and Mr. Smith turned to me immediately.

'I have here an encoded message and the code has been lost. As it concerns a tender made by a competitor of ours it is of the greatest importance to my firm to know what it is about. I propose, Mr. Rochfort, that you and I should set to work to decode the document. It may take several days, but that doesn't matter. My staff will run your house for you. I have with me a competent cook and manservant, so that neither you nor your friend will lack anything. The only stipulation is that you concentrate

on my business to the exclusion of everything else. Once you have decoded it I will pay you the sum of £500. Do you agree?’

I was amazed. Our cottage has only two bedrooms upstairs, a kitchen-cum-dining-room, and the sitting-room, which we had christened the parlour, downstairs, plus a small scullery we had built ourselves. We might manage to put up Mr. Smith, but there was no room for his servants. All the same, the fee of £500 would be very welcome, although the whole story somehow seemed rather odd to me.

Wanting time to think about it all, I answered, ‘Well, Mr. Smith, your terms are very generous, but we have made certain plans for this evening; besides we couldn’t put up your servants—as you see, we have no room.’

‘Oh, they can find lodgings in the nearest village and go there for the night; that’s of no importance. The point is, will you undertake to decode the message?’

I wished the fellow was not in such a devil of a hurry. I wanted to talk it over with Bob, who had an uncanny knack of knowing the right people and detecting the wrong ones. But £500!

‘I can’t guarantee that I can decode your message,’ I said cautiously.

‘In that case I will pay you £50 for your trouble, Mr. Rochfort. Now, is it a bargain?’

‘Well, I suppose so. Let me have a look at the message, anyway.’

I could not afford to let that £500 go—I needed it very badly.

Mr. Smith, who had all this time been standing puffing impatiently at his cigarette, seemed relieved. Out of his hip pocket he took a leather wallet and passed me a sheet of paper, on which the following letters were neatly typed:

EDCDEAEDAACDEA ADCBEA ECCDACDCEADEBD EBECCD
 ADCBBBCDADDE ADCBECAEBDAADCDA BADE ADCBCDEAEA
 CBAEDCDACDEADA EDBCAADCEABD EBECCD ECCAADECBAEACD
 ADCBEA EBBBCDBDAD DCAECCBAEACD ADCBBBCDADDE
 EBECAECD

I whistled. ‘Mr. Smith,’ I said, ‘this is not a code; it is a cipher—a bilateral substitution cipher, and it may take a very long time.’

‘That is as it may be; will you try to do it?’

‘Yes I will.’ I had decided that it might be interesting, and even £50 meant a lot to me at that moment.

‘Very well,’ said Mr. Smith. ‘If you will be good enough to show my servants the kitchen, we can start right away.’

I sat down at the old bureau and Mr. Smith ensconced himself in an easy chair by the side of the fire, apparently intending to do the deciphering with me. But just as I was going to start he said, looking at me, very gravely, 'Now, Mr. Rochfort, you will of course give me your word that the contents of this message will remain secret? You must promise not to mention either my visit or my business, to anybody. I know that I can take your word, and you will understand that anything you may learn must be regarded as confidential. And that applies to your friend too.'

At that moment his servant came in, wanting to see him about the car. He turned to me and said over his shoulder, 'Well, that's understood, is it not?' and left the room.

All this was very puzzling—his slight foreign accent, the business of the ciphered message, his question as to whether I was English. In point of fact, I am not English. Studying at Cambridge during the last war, I had joined the British Army and served for three years as a cipher officer; but although I had lived ever since either in England or in the British colonies in Africa, I had never taken the trouble to become naturalized. Nevertheless, I considered England as my country.

It was apparent at first glance that the cipher was not of a kind that is commonly used in business transactions. As only the first five letters of the alphabet were used, it looked as though it was what is called a square cipher, the key of which should look like this:

	A	B	C	D	E
A	a	b	c	d	e
B	f	g	h	i	j
C	k	l	m	n	o
D	p	q	r	s	t
E	u	vw	x	y	z

Of course the alphabet would not be used in this simple sequence, but would be somehow jumbled up. For ordinary business correspondence this would be much too complicated, especially when there are excellent code books in existence. Business codes are used both for secrecy and for economizing on cablegrams.

During the next few hours it became quite obvious that Bob and I were virtually prisoners in our own house. Although the cook busied

himself in the kitchen, where he produced an excellent meal for us, the silent manservant I noticed kept track of us whenever either of us went outside, if we were not already accompanied by Mr. Smith.

During our meal he spoke about books and London plays, and seemed to have an excellent fund of small talk, but was not very communicative about himself or his business. He asked many questions about ciphers, and was obviously pumping me for all he was worth. He also seemed interested in Bob's latest model aeroplane. Bob was an old pilot with an engineering turn of mind, and five years ago, an aunt having left him a bit of money, he had begun quite seriously to design models. He often talked of taking them up to the Air Ministry, but so far had done nothing about them.

The circumstances being as they were, I decided that I would try to puzzle out the cipher without letting Mr. Smith find out anything about it, and when I was sure that his business was really harmless I would let him know the results. Otherwise I would communicate with Scotland Yard. After all his yarn might be true, however fishy it sounded to me.

I worked on the cipher after supper. I was now sure that it was a biliteral substitution cipher using a simple square key, but the way in which the alphabet fitted into the squares would be very difficult to find out. I gave up trying to find the 'E', the most often used letter, as the message was too short to establish frequencies, and started straight word deciphering, for luckily the message was divided into words.

I had meant to do some more work on it in the privacy of my bedroom, but Mr. Smith was too clever for me, and when we were ready to go to bed he promptly collected all the papers relating to the cipher, and put them in a large file which he took upstairs with him. So that was that.

I tried to recollect the cipher, but apart from the first two words I could remember nothing.

ED/CD/EA/ED/AA,CD/EA AD/CB/EA

The second word was obviously one of three letters. In biliteral cipher two code letters are used for each plain text letter. Now the most common three-letter word is 'the'. If I took the meaning of ADCBEA to be 'the' and substituted these values throughout the message, I might spot something, but it would be pure luck if I did. I decided to do so first thing in the morning, and try also to make a copy of the whole message to hide in my pocket.

Fortune favoured me in the morning. Another car drew up, and as soon



I quickly copied down the message and hid it in my pocket

as Mr. Smith saw a short stout man get out of it, he hurried out to meet him. I quickly copied down the message and hid it in my pocket.

Mr. Smith talked excitedly to the newcomer. I pushed the window wide open, trying to catch their conversation, and somehow I was not very surprised when odd words in German floated towards me. I had already thought that Mr. Smith might possibly be a business man, but his business was in Potsdam and not in the city of London. Mr. Smith and his friend went round the house and I could hear no more.

As soon as I could, I substituted the values of the T, H, E

throughout my copy of the message. I got the following:

(1)	(2)	(3)	(4)	(5)	(6)	(7)
-- e	-- e	the	---	e	---	th-- t-- th
(8)	(9)	(10)	(11)	(12)	(13)	(14)
th- ee	---	e-	---	e-	---	t-- e-- the
(15)	(16)	(17)				
---	e-	th	---	t-	---	

The group number eight jumped to my eyes. A most likely word of five letters in which the first two were 'th' and the last two were 'ee' was 'three'; this gave me the value of 'r'.

But I had no time to continue. Mr. Smith was at my elbow, and fortunately found me making calculations as to the frequencies of letters to put him off the scent.

'Do you speak any foreign languages?' he asked me suddenly.

'Yes,' said I; 'French quite fluently.'

'Do you speak any German?'

'I used to know a little German,' I replied, 'but I have had no practice for so long that I have forgotten the little I knew.'

'And your friend?'

'I think he only speaks English.'

'You sympathize with England in this crisis, don't you?'

I thought it better not to deny that. 'Of course I do.' I looked straight at him. 'I have lived in this country for twenty-one years, and I like it.'

'We in America do not think that English policy towards Germany is altogether as free from ulterior motives as they pretend. They wish to keep the German colonies.'

'And why shouldn't they?' I asked. 'The right of conquest still holds. The Germans took possession of Czechoslovakia, and Italy annexed Albania after swallowing Abyssinia quite calmly.'

'Czechoslovakia was a German land; it is only the Treaty of Versailles which took lands from Germany. We in America of course dislike Germany emotionally, but I myself always try to be fair.' Mr. Smith was, I thought, trying to pose a bit too obviously as an American.

This little conversation was rather transparent. He was obviously trying to find out how much he could trust me, and I decided that it would inspire greater confidence if I was honest. I was now persuaded his business was not open and above-board.

It was absolutely impossible either for me or for Bob to communicate with any one. Mr. Smith was always on the spot. Our cottage stands quite alone in the fields, our nearest neighbour, a farmer, living about one and a half miles away, so apart from the telephone and the radio, we are rather out of the world.

Our wireless that morning gave an alarming account of Germany's

preparation to seize Danzig. Although we were quite accustomed to crises and rumours of war, this time it looked rather like the real thing.

Mr. Smith was quite perturbed although he appeared to try to conceal his anxiety. I managed to be alone for fifteen minutes or so again, and I quickly wrote in my copy $CD = R$. This gave surprising results in the similar fifteenth and sixteenth groups which were $th(BB)rt(DE)$ and suggested 'thirty' right away. Also I was struck by the fourth, eleventh, and seventeenth groups, of which the first two were similar three-letter words, and the last was the same but included one more.

Mansfield's frequency table gave the three-letter words next in frequency to 'the' as 'and' and 'for'. If I took 'for', since $CD = R$, for these groups, it was easy to see that the seventeenth group— $f, o, (AE), r$ would be 'four', where $AE = U$.

I placed the sheet of paper in my pocket just as Mr. Smith came back into my room and said impatiently that he would have to get back very soon and I must try to solve the cryptogram quickly. After a while the discussion became rather heated; I foolishly lost my temper and pointed out to him that I objected to being kept a prisoner in my own house. It was not part of our original agreement.

He laughed at that and said it would not be so bad if that was my only trouble, threatening me suddenly with mysterious consequences if I was to go back on the agreement or was going to talk about the affair. In the excitement of the moment I thought the best way to get into touch with the outside world would be to lift the telephone receiver off the stand and hope that some one at the exchange might overhear our conversation. I managed to do this without his noticing it, and after that I egged him on. He very quickly lost his temper and shouted at me.

'Mr. Rochfort, there are times when ordinary polite relations are suspended. This is as good as war-time, if you only realize it, and if you do not want to come to any harm you had better solve this crypt; otherwise I shall have to take stringent measures. You must do it for your own sake. Do I make myself clear?'

At that moment he stood up by the fire-place, and being tall, he could see behind the top of the bureau which was facing the window, on the sill of which we kept our telephone. He saw the telephone receiver off the stand.

He immediately reached over and replaced it. Then he turned to me and said quite calmly: 'You will realize that now, Mr. Rochfort, we have

to understand each other. Resistance is useless and you will have to obey my orders. I shall take both you and your friend away in my car, and if you want to see your home again you had better decipher this message very quickly. We have no time to lose.'

He left the room to tell his servants of the altered plans, and a moment later Bob ambled into the room. I managed to tell him what had happened, and he, who had been rather more interested in the whole thing than I had thought, whispered back, 'Don't fight him, whatever happens. We may find out something of importance.'

When Mr. Smith came in again we both put on indignant expressions, but Mr. Smith had us bundled into the car, the blinds of which were drawn.

II

By now I knew the whole message by heart, and as we were being driven very quickly in an unknown direction I tried to recapitulate my findings. Obviously the first thing I should do was to solve the cipher secretly for myself; then I would know what it was all about. I was quite sure that the moment I gave a couple of clues to Mr. Smith he would not let me finish the deciphering but would do it himself, so that he could still keep the message secret from me.

The cryptogram in my mind now looked like this:

'(ED)re(ED)(AA)re the or(AC)(DC)ey(BD) for thirty thou(BD)(AA)(DC)(DA)
(BA)y three hu(DC)(DA)re(DA) (ED)(BC)(AA)(DC)e(BD) for o(CA)to(BA)er
the fir(BD)t (DC)u(CC)(BA)er thirty-four.'

Now the fourteenth group—fir-t—must be 'first', in which case it looked like a date, and the twelfth group which was o-to-er equals 'October'. This deduction gave me the value of $CA = c$, $BA = b$, and $BD = s$, which are three very important letters. Knowing all these letters, I could have reconstructed the cipher square without any difficulty, if I had had pencil and paper. But under the circumstances this was impossible. On the other hand, to keep on the right side of Mr. Smith I had to show him some progress, so I gave him the deduction of ADCBEA (second group) as equalling 'the' and let him get on with that. I did not think it would be of any help to him.

We were being driven in an easterly direction. It was morning, and through the chinks at the sides of the window blinds I could see the sun coming in mostly from the front of the car. But very soon we halted. Mr. Smith got out and slammed the door very quickly; then, after a little

manœuvring, our car slowly went up a steep incline, while some directions were being shouted to the driver. Then the car stopped and we were in complete darkness. A low rumble, however, was soon heard again, and we started to sway slightly and move forward. From the noises coming from the darkness and some talking, it seemed to me that men were busy lashing the car to something with ropes. I realized that we were inside a large covered lorry, and I remembered the gangster films in which cars, to escape pursuit or detection, were taken inside vans and so evaded the detectives. But were we pursued?

Bob did not show any sign of anxiety or worry. He sat quite calmly, occasionally smoking a cigarette, and smiled benignly when Mr. Smith came in and switched on the interior light.

Mr. Smith brought me a pad and pencil, as well as some fruit, and seemed pleased that we were taking the whole thing so calmly, apparently taking for granted the extraordinary circumstances in which we found ourselves.

We continued with our work. He explained that we would soon have lunch, but that at the moment the delay was inevitable. He played the part of a host very well, and the idea of abduction seemed for the moment quite absurd.

As soon as Mr. Smith left us alone I tore a sheet off the pad and wrote all the letters I had discovered so far.

	A	B	C	D	E
A				t	u
B	b	i		s	
C	c	h		r	
D					y
E	e	f	o		

Bob suddenly nudged me, and I wrote in very quickly the 't's', 'h's', and 'e's' throughout the message. I did this for Mr. Smith's benefit, feeling that I had to show him something, and hoped he would not spot the eighth group which had given me the key, ADCBCDEAEA = three.

It was just as well that I did so, as Mr. Smith appeared again and this time sat down in front of me. I thought that Bob must have heard him coming but it appeared afterwards that he had seen him looking through the chink in the front blind. They were still drawn.

All this time we were travelling at a pretty high speed, judging by the swaying and jolting we were experiencing. I complained to Mr. Smith that it was not very conducive to concentration, but he said that we were not very far from our destination.

That cheered me. I knew that as soon as I could have another quarter of an hour to myself I could decipher the whole of the message, and even if Mr. Smith could make head or tail of it with the clues I had given him, it would take him considerably longer than it would take me, and therefore I was safe for the time being; but how could I convey the information I should then have to the authorities? We were now completely his prisoners, and it seemed unlikely that he would let one of us leave him. On the other hand, I had an old friend with the Inner Security Branch at the War Office who would no doubt be intensely interested to know the contents of the message and who, moreover, could get the machinery of Scotland Yard on the move to bring about our release; but how to let him know? For by now I felt that the message had some political significance.

The van stopped suddenly and Mr. Smith hurried out. I asked Bob if he remembered my friend Geoffrey's telephone number at his office. He had it pat. I told him that should any opportunity present itself he must try to slip away from the tender care of Mr. Smith and communicate immediately with Geoffrey. Bob very kindly suggested that if Mr. Smith discovered him missing, he would probably put my head under the wheels of his car. I pointed out that Mr. Smith had a greater regard for my brains, and that as long as the message was not deciphered, I was safe. Then Bob volunteered the information that he had taken the trouble to notice and jot down the number of our car, which was FOP 136. At that moment the car we were in drove backwards out of the lorry into the sunlight. Peering through the blinds, I saw that we were in a lonely spot on the road in a part of the country I did not recognize. Mr. Smith looked in and informed us that we were within a few miles of an inn that belonged to a friend of his—this he rather emphasized—where we were going to have our belated lunch. The blinds were still drawn and we must have driven straight into the back yard of the inn, for when we did get out of the car I could not see the name of the inn anywhere. It was, I felt, rather important to know our whereabouts, but all I could do was to surmise that we were somewhere in the eastern or even north-eastern counties.

We went into an empty room. All my wild ideas of passing a written

message to a complete stranger went by the board. But as soon as we had got in Bob expressed a desire to wash his hands. 'Certainly,' said Mr. Smith, 'my servant will show you the way.' The silent and sinister-looking manservant opened the door for him and he left. Mr. Smith suggested that I could do some more work while we were waiting for our food, so I got out my pad and we discussed the next plan, based on the fifth group being 'thirty'. That would not take him very far either, I thought.

He left shortly afterwards, and except for the cook, who sat stolidly at the far end of the room by the door, guarding me, I was alone. I got my square out quickly, but even a superficial look at the cipher with all the new values written in showed surprising results. The sixth group looked like this now: *thous(AA) (DC) (DA)* which surely stood for 'thousand'. That gave me the values of 'a', 'n', and 'd'. The whole message then looked like this:

-RE-ARE THE OR-NEYS FOR THIRTY THOUSAND BY THREE HUN-
DRED --ANES FOR OCTOBER THE FIRST NU-BER THIRTY FOUR

That seemed a funny kind of a business tender submitted by Mr. Smith's competitors, and although I could not offhand get the hang of the message, I felt more than sure that this was something that would interest Geoffrey. Bob then came back and Mr. Smith followed him in. I knew that something had happened, for there was a glint in Bob's eye that I had learnt to recognize twenty-five years ago when we were fighting side by side. But he had the proverbial poker face of the Englishman, and it had taken me many years to recognize that glint. I was sure that Mr. Smith saw nothing. He did not volunteer any information, so I concluded that it was not of a nature he would wish Mr. Smith to know. As it was so late, we ate a combined lunch and tea, and although I had expected to be whisked away immediately after we had finished eating, this was not to be. Mr. Smith had a couple of easy chairs brought into the room, and arranged a small table near the window so that we could work; but as soon as we had sat down he was called away again. Then Bob, without saying a word, managed unobtrusively to pass me a note. It read:

'Phoned Geoffrey and told him about us, also gave him the number of our car, couldn't say where we were, was interrupted but no one heard.'

I breathed a sigh of relief. Every road policeman in England would

be looking for us in half an hour, and I felt really glad for the first time in my life to know that they were about on the roads.

To delay the deciphering, I now started Mr. Smith off on the counting of frequencies. Certain letters are used more often than others, and frequency tables have been calculated which show that the letter 'E' appears almost twice as often as the next most frequent letter, which is 'T', followed by 'R' and then 'I' and 'N' together. With slight variations and allowing for accidents, these frequencies can be relied upon to appear with an almost mathematical precision, but the message to be deciphered must be a very long one before these frequency laws can provide the clue. I knew that the cipher in question was not long enough for this method to be of any use, and that this would prove to be a red herring for Mr. Smith.

Just as it was getting dusk he said that after we had had supper we were to get into the car. Bob and I were much less anxious now. I knew that very soon when we were on the road we would be intercepted, and that it would mean good-bye to Mr. Smith.

We had an excellent supper, after which we walked out into the yard. Facing us was the back of the car, which was ready to be driven out through the gates. The number plate was staring at us, and the number was not the one that Bob had taken that morning. I realized that it had been changed, either while we were in the van or else while we were having our meals, and as we passed close to it we could see that the paint was still wet on the alterations. The original number had been FOP 136, and only a few deft strokes were needed to alter this to EQR 486.

We got into the car, which drove off at a tremendous speed into the dusk. We drove through a few villages, which we could just discern on account of the lights. Mr. Smith sat with the driver, and the manservant sat with us in complete silence.

Suddenly a police car gong sounded close behind us. We heard a shout as they passed us, to draw up on the near side. The car stopped; Mr. Smith promptly jumped out of his front seat and got in with us, and before we knew what was what he took out a revolver which he pointed at me while he looked at Bob.

'I'm sorry, Mr. Cummings, but one word or gesture from you,' he said, and there was a nasty rasp in the way he said it, 'and your friend will not live to see another day.'

I was just going to make a fight for it when an almost imperceptible



He took out a revolver which he pointed at me while he looked at Bob

shake of Bob's head made me realize how stupid that would be. We were two to three and they were armed and we weren't; also, if we really wanted to find out anything we had to sit still and wait. Besides, what were the police doing?

Our hearts gave several extra beats. I thought that by some miracle Geoffrey had discovered our car and the police were going to arrest Mr. Smith. I then heard the policeman's voice outside speaking to the driver.

'Sorry, old man, but your back light has just gone phut; I saw it flicker and go out just now. It's probably only the bulb.'

This was terrible. It meant the end of all our hopes. We heard the driver and the policeman go towards the back of the car, and the policeman was obviously helping the driver to unscrew the rear lamp cover. Sitting

half turned as I was towards Bob, I could just see the two forms against the window.

'No, it's not the bulb,' said our driver; 'it looks like the cable. As I jerk it, it lights up, you see. I'll fetch some insulating tape.'

The policeman was still tinkering with the lamp, and although he was so near, I was powerless to do anything. Inside the car the tension did not abate.

But within a couple of minutes or so the rear lamp was permanently alight, our driver bid a hearty 'Good-night and thank you' to the constable, and off we went again. The policeman's car was the first to move off, and Mr. Smith decided to relieve us of his attention and drive. I daresay he needed some fresh air. He did not say a word, and I thought that perhaps he did not really relish using such gangster methods.

However, we did not go very far when one of the back tires went flat. I heard Mr. Smith swear softly as he got out. Then things happened very quickly. A couple of very bright headlamps shone in front, straight at our car; we heard several running footsteps; some one shouted: 'That's them,' then: 'The game's up; put your hands up,' and our door was thrown open by a burly policeman. I had never seen such a desirable sight.

'Are you Mr. Rochfort?' he asked.

'Yes,' we gasped in one breath.

'Here they are, Inspector, safe and sound,' shouted our policeman to some one in the darkness, and then said, remembering his dignity, 'Well, that's that.'

An Inspector, still holding a revolver, came up to us from a group of policemen, in the middle of which were Mr. Smith and his two assistants, all looking rather scared.

'He has got a gun, Inspector,' I volunteered.

'I've relieved him of it already, Mr. Rochfort,' said the Inspector and added, 'I'm glad we've got you at last; but Colonel Bingley is waiting for you. If you don't mind we'll take you to London in our car, sir. I'll tell the Sergeant to telephone through to him at once to say you're coming.'

We got into the back of the police car. I asked him where we were, and it appeared that we were near Harwich.

While we were speeding back to London with superb disregard for speed limits and such trifles, occasionally sounding the police gong to

clear the road, I asked the Inspector how they had spotted the car when they had the wrong number.

It appeared that the first policeman who stopped Mr. Smith's car on account of the rear light, while helping the driver to fix it, had rubbed against the fresh white paint on the rear number-plate. His suspicions were aroused, and while the driver went to fetch the insulating tape he had looked closer and found that it had been FOP 136, which number had been broadcast by Geoffrey. Realizing that he was outnumbered and that probably some of the members of the party were armed, he had slit the back tire with his penknife and had then gone on quickly in advance to give warning. The inspector had collected two more police cars, and all three trailed Mr. Smith until he was forced to stop on account of his puncture.

Geoffrey, in spite of the late hour, was waiting for us in his office, having phoned through to his wife, telling her that he was bringing us back for the night.

I explained to him all that had happened and showed him the cipher message, which now read: 'Prepare the or(?)neys for thirty thousand by three hundred planes for October the first number thirty four,' though it did not seem to me to make very much sense.

As soon as he saw this he sat heavily back in his chair and fumbled for a cigarette.

'What's the matter, Geoffrey—anything wrong?' I asked.

'My dear fellow, the third word which you did not decipher is ORKNEYS. In the event of war the Nazis had a crazy plan of dropping 30,000 troops by aeroplanes there and making the islands their base for bombing our fleet at Scapa Flow. We knew all about it and had prepared a warm reception for them; but since the cat is now out of the bag, I suppose they will just drop this plan and we'll have to find out all about their next one. That's all. None of this is new to us and I wouldn't be surprised if we've got the real name of "No. 34" on our files. The Germans were always rather heavy-footed with their spying; we've got their original code book, and this message was enciphered apparently on the spur of the moment with a new key which they had forgotten to give to our friend Mr. Smith, whose real name by the way is Schmidt. Anyhow we'll find out about that to-morrow, so come along now; my wife will be waiting for us—she'll want to hear all the details of the chase.'

And that was that.

THE LOST BALL



BY MAJOR
J. T. GORMAN

I

THROUGH the morning air came sounds typical of army life in India. The strains of the latest dance tune came from beneath the shade of an enormous banyan-tree where the band was practising; bugle-calls kept up a musical running commentary on the morning routine. Crows cawed, kite-hawks whistled, voices buzzed bee-like from the hive of mud huts forming the lines of the Indian regiment.

Lieutenant Ruthven Spencer and his immediate junior, 2nd Lieutenant Ramdyaal Singh, crossing the beaten earth of the *maidan* or plain towards the officers' mess, found it dotted with parties of sepoy in process of training.

Here a group studied signalling, others toiled at the loading of recalcitrant mules and camels with singularly little collaboration from their four-legged fellow pupils, while a third party was busy with the intricacies of the machine-gun.

With a jerk of his head towards this group Spencer laughed.

'Mechanization somehow seems out of place in Khundwala,' he said. 'It's the sort of spot where nothing ought to change.'

'No, it's the old India.' Ramdyaal Singh, descendant of an ancient Rajput family, nodded. 'I think I like it.'

'Oh, it's restful enough—beautiful too.' Spencer looked away across the *maidan* at a scene like all the ideal pictures of India ever painted. Mosques, temples and turrets, the ruins of the old deserted city of Khundwala, cast shadows across the surface of the Sutlej which gleamed through

groves of pipal and banyan as it flowed serenely on to receive the waters of those other great streams that give their name to the Punjab, the land of the Five Rivers.

Between river and *maidan* was the Bhandar Topi, orange groves of immense antiquity surrounding a marble tank. In these trees and the adjoining strip of jungle lived hundreds of monkeys held sacred by the people of Khundwala and the priests of the nearby temple.

For a moment the two young officers were silent, then Spencer shook himself.

'Won't do to let ourselves get too moss-grown—even if we are the regiment that Simla forgot!' he said.

'We shan't do that as long as we keep the ball rolling—and the cricket-pitch rolled.' Ramdyaal laughed, glancing towards that immediately smooth, sanded surface. 'At present it's good enough for Lords.'

'And so it ought to be, my son, with our cricketing reputation in the army to keep up,' Spencer rejoined.

The 1st Battalion of the Mooltanee Grenadiers, a gallant regiment with a fine history, owing to some extraordinary memory lapse of the Olympians at Simla, had been stationed at Khundwala for eight years and seemed unlikely ever to be relieved. All ranks took this unusual departure from military procedure with resignation, and accepted the consequent amenities as heaven-sent. To them, Khundwala had become a soldiers' paradise, where, remote from main trunk-roads and railways, unvisited by brass hats, they could train for war in peace, devoting their leisure to sport—above all to cricket.

For the Mooltanee Grenadiers were, first and foremost, a cricketing regiment, and Spencer and Ramdyaal were two of the keenest exponents of the game, with which at the present moment they were particularly preoccupied.

Walking on towards the mess, Spencer paused to hail the signalling group.

'Havildar, send Lance-naik Girdhari Ram here!'

A tall, well-built young sepoy, with bright, intelligent dark eyes, left the group and ran towards them. As he saluted, standing to attention, Spencer spoke again.

'I've great news for you, Lance-naik,' he said. 'We're going to play the famous English Eleven who are touring India. They're passing this

way on their route to the north and they've asked for a game with the Grenadiers, a three-day match under the rules of first-class cricket. So we'll see what you can show 'em with those wonderful googlies and spinners of yours, eh?'

The young sepoy flushed with excitement and surprise. Stammering and nervous, he managed to convey that although his bowling might be adequate for regimental cricket, he had doubts where an English team was concerned.

'I am not good enough, Espencer sahib,' he ended earnestly.

'Rot, Girdhari Ram! It's been done before and there's no reason why it shouldn't happen again—why you shouldn't be a second Lance-naik Bahadur Ali. Haven't you seen his ball in the mess—the ball that is always put on the dining-table on guest nights? Come along and we'll show it you. It ought to be an inspiration, eh, Ramdyaal?'

Still looking doubtful, Girdhari Ram followed the young officers to the anteroom of the officers' mess, which might have been a sealed pattern for all anterooms in every regiment in India. One wall was occupied by the Colours with battle-honours glittering gold in the sunlight, surmounted by the bugle which had sounded the charge at Plassey. On the opposite wall hung trophies of the chase—a tiger's skin, a snow-leopard's head, an elephant's tusk of enormous dimensions, the head of a markhor with horns that were said to beat all records.

But Ruthven Spencer went straight to a sideboard, holding a few silver cups for shooting and polo, with a far larger number for cricket. All-India Cup, Punjab Challenge Trophy, Central India Challenge Shield—these surrounded and seemed as it were subservient to something that appeared at first glance to be an insignificant object amid such proud trophies.

On a small, black ebony plinth, under a crystal case, stood a tripod of silver cricket-bats and stumps on which rested a single cricket-ball, its red leather so well polished and tended as to appear new. Beneath, on a silver-plate stand, was engraved: 'With this ball Lance-naik Bahadur Ali of the 1st Mooltanee Grenadiers took five wickets in one over in the match between the Regiment and the All-India Team on 21st December 1911.'

II

Lance-naik Girdhari Ram was in that state of nerves known as the jitters.

The condition had grown worse daily since the fixture between the Grenadiers and the visiting team had been arranged: it was much more acute now that the third and all-important day of the great match had actually arrived.

Curiously enough, Girdhari Ram would have felt happier if there had been any doubt about his being chosen for the regimental eleven. But in all discussions, official or unofficial, his inclusion had been taken for granted.

Those discussions had been many and heated. In the lines over hookahs and *pan sapari*, on the parade-ground, groups of non-commissioned officers and men talked over the team's make-up; overheard fragments of conversation always bore on the same theme.

'Did not San Waliya Ram at practice yesterday make 100 not out?'

'Aree! He's no good—he'll never do it again. That was just luck.'

'Have you seen Jafar Ali bowling . . .?'

'They must find a place for Bir Singh. . . .'

'Fazal Ellahi's the only possible wicket-keeper. . . .'

Everyone pressed the merits of his special favourite; no one listened to any one else; probables, improbables, and possibles were violently canvassed.

The Subedar-major, a Sirdar Bahadur and himself an old cricketer with a record of 200 not out against the Maharaja of Thargargh's formidable team, poured cold water on these unofficial opinions, bringing would-be selectors to their senses.

'There's too much talk,' he said. 'To-night the Colonel Sahib holds a Council of five, a *Panchayet*, to decide who will play.'

That evening the battalion gathered in strength to hear the decision of the Selection Committee, consisting, according to old Indian custom, of representatives from each of the four companies, presided over by the colonel.

It was not easy to choose from six hundred stalwart Indian soldier-cricketers, but the cheers greeting the names of those selected showed the regiment's approval—and Girdhari Ram's name drew louder applause than any other.

They expected too much of him, the young Lance-naik decided miserably, wandering round the cricket pitch during the intervening days of practice and preparation, and repeated his fears to Spencer and Ram-dyaal Singh.

'My heart sinks, my knees and wrists lose their strength. I fear so much to fail that I shall surely do so.'

'Nonsense, man, you'll come up to scratch; you'll never let down the side,' Spencer encouraged him; but Girdhari Ram shook his head drearily.

'But that is just what I'm afraid of,' he said. 'I do not feel myself good enough.'

He practised feverishly—but all the regiment did that. Cricket was in the air. Aiming-marks and dummy targets were replaced by stumps painted on mud-walls, pitches were marked out on all available empty spaces; practice nets were set up at intervals round the lines.

Cricket levelled all ranks: captains, subalterns, even senior majors stopped, passing across the parade-ground, to join a circle where catches were in progress, or to field a ball hit by some enthusiastic batsman.

And now, on the third day of the match, Girdhari Ram's hopes and spirits were at their lowest ebb. It had been perfect weather, intensely warm, but with a cool breeze drifting intermittently through the trees of the Bhandar Topi. The sunlight flashed from stumps, bats, and balls, the sky was unclouded; but Girdhari Ram would have welcomed an earthquake to end the match prematurely as he fielded at slip, alert in spite of his dejection.

From the two large *shamianas* or marquees, from the packed spectators, came voices: 'Well played!' 'Oh, good hit, indeed!' 'Well bowled, sir!', with 'Ahs' and 'Ohs' at an attempted catch missed, or a hair-breadth escape as a ball whizzed past the stumps.

The match hitherto had been a long spell of spectacular cricket. The Grenadiers, after winning the toss, had scored 310, Ruthven Spencer carrying out his bat, while San Waliya Ram, Jafar Ali, and Fazal Ellahi all justified their inclusion in the team.

The English team, however, followed up with a score of 325. The Grenadiers, not to be outdone, had made 260 for their second innings, leaving the English eleven with 246 to score for a win.

This morning their batsmen had accordingly dug themselves in, playing fine cricket; now, with the tea interval imminent, they were four wickets down for 170.

Six wickets to fall, and 76 to win; stumps to be drawn at 6 o'clock. Six wickets to fall and 76 to win! One could almost hear the commentator in a National radio programme repeating these words.

They rang ominously through Girdhari Ram's mind, for he, the Grenadiers' hope, their demon bowler, had fulfilled his own worst fears, failing ignominiously that morning to take a single wicket—and this in spite of a worn patch which gave all the chances he needed, granted his usual skill.

But that was lacking, and there was consternation among the Mool-tanee Grenadiers, both team and spectators.

A community sigh of relief greeted the tea interval. Ramdyaal Singh, seeing Girdhari Ram walking dejectedly towards the players' *shamiana*, went to meet him.

'Cheer up,' he said kindly. 'I'm sure the luck will turn now. You'll do better when you go on again after tea.'

'No, Lieutenant Sahib,' Girdhari Ram shook his head. 'The ball has a devil: it will not go as I wish.'

'It'll be time for a new ball. *Then* you'll strike that worn patch.'

'No, Sahib,' the Lance-naik repeated. 'Only one thing could help.'

'What's that?' Ramdyaal Singh asked.

'If I could use that ball from the *mess kote*, the ball of Lance-naik Bahadur Ali. I feel I could do great things—perhaps as great as he.' Ramdyaal Singh stared.

'But that's impossible!' he said.

'I know it, Sahib. I speak only foolishness. Yet I feel I am right.'

'You may be. If one believes a thing strongly enough—All the same, that ball—I don't see how—'

'Don't think of it more, Sahib.'

'If it were possible! Wait, I'll speak to Spencer Sahib. After all, he's captain.'

Ramdyaal Singh ran to join his friend.

'I say, Spencer,' he spoke breathlessly, 'it's Girdhari Ram—he swears if he's allowed to bowl after the interval with Bahadur Ali's ball he'll do wonders—perhaps take the six wickets.'

'Good lord, man, you're joking!' Spencer laughed.

'I'm not. I mean it—at least, he does. He believes there's *jadoo* in the ball—magic. Spencer, is it absolutely impossible to let him have it?'

'Superstitious nonsense! How can it make any difference to his bowling if he uses that old ball?' Spencer grumbled.

'It will!' Ramdyaal Singh spoke confidently. 'I know my own people,

Spencer, and what faith in anything can do with them. After all, as regards the game, we can't be worse off than we are now. Six wickets to fall and only 76 to win.'

'Don't I know it? You needn't rub it in. But an idiotic stunt like that won't do any good.'

'It might. It's worth trying; and if you won't help, Spencer, I'll take the ball myself, I swear I will!' Ramdyaal Singh declared desperately.

'I say, you can't! There'd be the most unholy row if you were caught. It's got to be on the table to-night at mess.'

'I know—but I'll put it back before dinner-time. Honestly, Spencer, I wouldn't suggest it if I didn't feel sure it would give Girdhari Ram a chance——'

'Oh, very well then!' Suddenly Spencer gave in. 'I think it's most awful drivel, but if you really believe there's anything in it—well, I'll say no more. And—look here! I'll pinch the ball from the glass case myself—I can manage it better than you, Ramdyaal; you'll only give yourself away by stammering and blushing. I'll see that Girdhari Ram has it instead of the new ball when I put him on again after tea. They've only 30 to score to bring it up to the 200 runs, which won't take 'em long, I'm afraid. That do?'

'Do! I should think so! It's most awfully good of you to help, Spencer. I'm sure you'll not regret it——'

'I shall if I'm caught! I'll get it now while there's nobody about. Go and give Girdhari Ram the glad tidings, and tell him that if he doesn't do Bahadur Ali credit I'll never trust *jadoo* again!'

Spencer strode off towards the mess, while Ramdyaal Singh returned to the Lance-naik and the English and Grenadier teams discussed matters over tea, little thinking that wizardry had been summoned to transform the game.

The scoring after tea was not so fast as Spencer expected. It was 5.35 before the English passed their 200 runs, their fifth and sixth men having dug themselves in and played cautiously.

The partnership seemed indeed thoroughly set when 206 stood on the board and Spencer beckoned to Girdhari Ram to take the bowling—with that supposedly new ball that held such magical possibilities.

Four wickets for 206: only 40 to win—but the words were no longer ominous for Lance-naik Girdhari Ram.

The atmosphere had changed for him. Otherwise it was still charged with the complete certainty of success for the English team. The batsmen were cocksure, the fielders grimly despairing, the umpires on their toes with expectation, while the man at the scoring-board waited impatiently to send up those wobbling figured squares which all the spectators expected confidently in tense silence.

And then, in a split second, something entirely unexpected happened. It was as though the unsteady streak of quicksilver in a thermometer elected to take a definite stand.

The bowler took his run, with a pit-a-pat of feet, the batsman played the ball defiantly, but immediately came one of those clicks so musical to a bowler's ear. Caught in the slips! The ensuing surprised silence was broken only by the metallic clatter of the figures on the scoring-board and the resolute tread of the new number seven taking his place, until the Grenadiers' supporters came to life with belated applause.

Again the bowler's arm whirled up in taking his run; this time a sharp crackling sound followed as the ball caught the new-comer's centre stump and sent it flying, while the bails scattered like skittles.

Six wickets for 206—and precious time was passing.

Awaiting the rather tardy arrival of the eighth batsman, Girdhari Ram polished the ball on the seat of his trousers, breathed on it, rubbed it with his palm. Afterwards the regiment said he had done *puja* to it.

The new English batsman took up position less confidently than his predecessor. His uncertainty was justified. Girdhari Ram bowled—and the off-stump flew out of the ground, this time to a chorus of cheers and shouts.

Fresh hope walked to the wicket in the shape of the English ninth man. He had been their star turn all through the tour, and the team held their collective breaths and gave him a blessing as he prepared to receive what seemed, deceptively, the easiest bowled ball in cricket history.

But when he regained the pavilion, with the scoring-board displaying an ignominious duck, he found little to say in self-defence.

The tenth man was plainly nervous even before he took position. The spinning ball came down, found that worn patch which had eluded Girdhari Ram until this over, and did its dread work in spite of the batsman's futile effort to stop it.

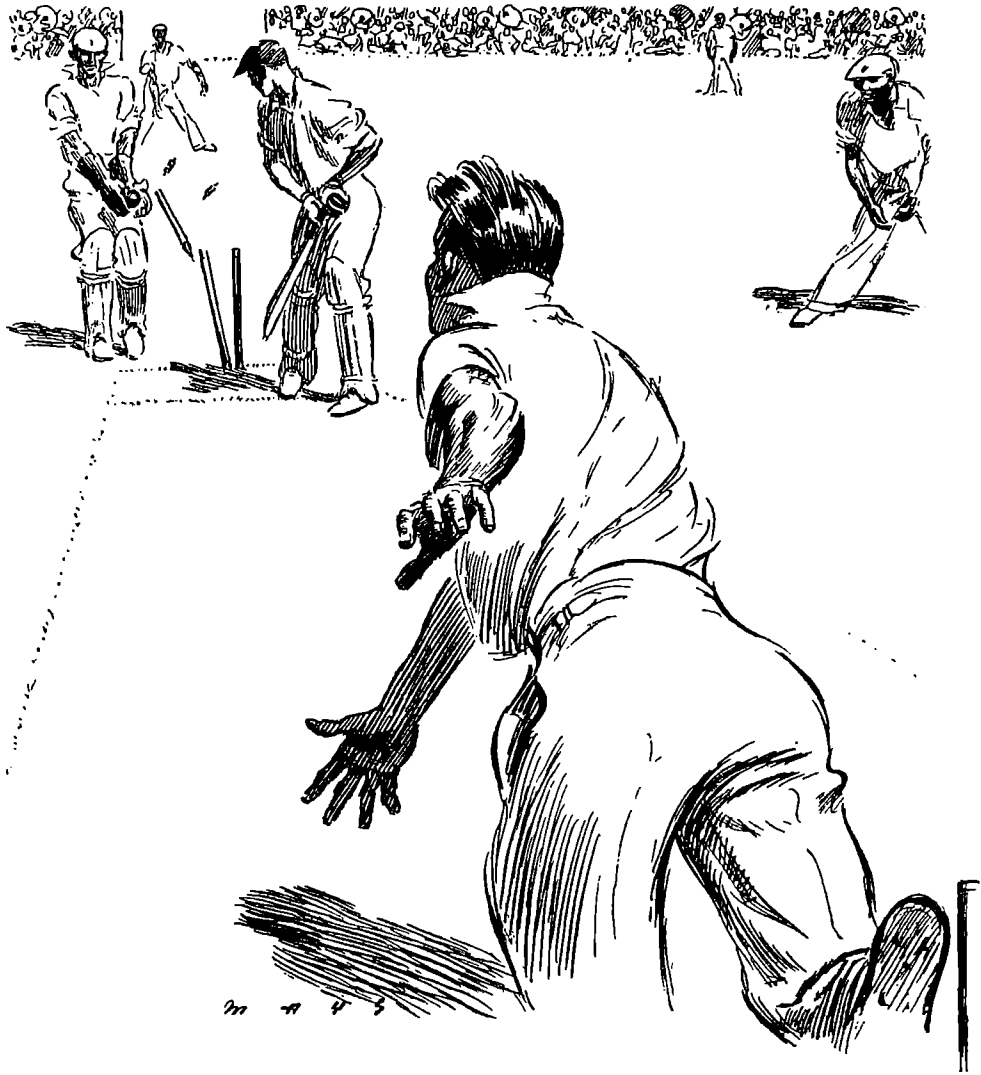

Girdhari Ram bowled—and the off-stump flew out of the ground

He took his place among the fallen and the score was 9 wickets for 206, with four minutes to go before stumps were drawn.

The tail-tip of the team was a giant of a man, who strode out with the obvious intention of making some sort of mark, wiping out somehow the failure of his predecessors.

As Girdhari Ram bowled, the batsman opened his shoulders and smote. The sound of the impact might have been heard for miles, or so it seemed, and the ball soared upwards swallow-like, whizzing between Ramdyaal Singh and another fielder, away to the boundary.

The umpire held up both hands to notify the six of a boundary hit, then signalled the end of the over. Inexorably the pavilion clock struck six, synchronizing with the click of the bails as they were flicked off.

The match was over.

III

Girdhari Ram had already given one outstanding display; now he provided another sensation.

Clapping, shouts of applause, cries of '*Girdhari Ram ko manghta—we—want—Girdhari Ram!*' acclaimed the performance, but the leading actor failed to take his curtain in the usual fashion.

With straining eyes he had watched the ball soar away to the boundary, followed its flight towards the feathery tamarisks of the Bhandar Topi, with Ramdyaal Singh in full chase. When pursuer and pursued disappeared, Girdhari Ram could stand the strain no longer. His one thought was that the ball must be recovered and replaced in the ante-room before being needed as the central ornament on the mess-table that night.

Running off the field at full speed, he was close on Ramdyaal's heels as both raced into the grove—and pulled up simultaneously. For there on a patch of sandy ground fifty yards away the dark red sphere had come to rest.

'Good! It's safe!' Ramdyaal Singh sighed with relief. 'I'd an awful idea that it might be——'

He broke off with an exclamation of consternation, echoed by Girdhari Ram.

Down from a tall pipal tree dropped a lithe, lean grey shape, paused for a second, wicked eyes gleaming, then pounced to seize the ball.

Quick as it had come the monkey darted back with the prize to its companions, and sat there in the tree gibbering loudly, pawing over the fascinating object it held.

'Aree! The magic ball! What shall we do?' Girdhari Ram cried despairingly.

'We must make the brute drop it!' As he spoke Ramdyaal Singh snatched up a pebble and threw it at the monkey, who only chattered angrily and sprang to another branch.

The shower of stones and sticks that followed sent the whole tribe bounding away around the ball-thief, pausing occasionally to peer down and jabber derisively.

There was nothing to do but follow, a nightmare pursuit through the grove into the jungle patch beyond, waist-high in grass, then splashing over marshy ground.

Panting, dripping with perspiration, not daring to pause for fear of losing sight of the quarry, it was not until after half an hour's hard going that they reached the outskirts of a village, where the monkey band dispersed.

The two saw the ball-thief linger behind its comrades and skip down on to the curb of an old well from a banyan-tree which shadowed it, and sit there, re-examining its loot with careful thoroughness.

Even while they planned a strategic movement, the monkey caught a glimpse of its own reflection in the water below. Gibbering excitedly, it peered over, made a grab for the shadow, and let the substance fall from its skinny fingers.

A concerted rush sent the beast scampering, but even then it was some time before they located the elusive ball, lodged in a bush which grew out from the well-side.

After that, it was a matter of minutes for the 2nd Lieutenant to lower the Lance-naik in the big leather *chagul* or bucket, and to haul him up again holding the precious ball once more in his hand.

But even now the main question remained: could they possibly return it to its place in time? More than five miles to go—and a bare three-quarters of an hour to dinner-time.

Without a word to each other, the pair put out all their sprinting powers. Gasping, exhausted, Ramdyaal Singh staggered up the steps of the veranda as the second mess-call rang out over *maidan*.

A glance told him that guests and hosts were already assembled in the ante-room. No hope there—but was the empty case on the dining-table? With sinking heart he hurried to the other door and looked through into the dining-room.

Whiteness of cloth, sheen of silver, sparkle of glass, brilliance of flowers dazzled his tired eyes, and—he rubbed them, bewildered—on its stand, the Ball!

Utterly confused, Ramdyaal Singh stared from the ball in his hand to the ball on the table. And as he stood there a hand descended on his shoulder. He turned to face Ruthven Spencer, in mess kit, grinning into his frightened face.

'What's up? Why aren't you dressed?' the Englishman demanded.

'The ball—the ball you brought——' the young Rajput stammered incoherently. 'Tell me, am I mad? Or is it more magic? How can it be there—and here?'

Spencer laughed and took his arm.

'Come along and dress,' he said. 'I'll tell you on the way. It's all very simple. You see, I'd no faith in your idea about the ball and Girdhari Ram, and I felt sure besides that the old thing would drop to pieces in spite of all its spit and polish—but I thought I'd give you and our crack bowler the chance.'

'So you *did* bring it? It was the ball? Then—why?'

'I didn't and it wasn't. I merely took the ordinary new ball out of the bag when the time came, passed it to the other captain and the umpire for inspection—and Girdhari Ram did the rest.'

'Then it wasn't the magic ball after all?' Ramdyaal Singh stared stupidly at his friend.

'No—but Girdhari Ram thought it was and that's all that matters! It did the trick, so I take off my hat to all three of you!'

'Those wickets were taken by an ordinary ball?'

'Yes, a common or garden cricket-ball—but, mind, we mustn't tell Girdhari Ram. Faith's a wonderful thing and, by Jove, he's proved it to-day. It was a victory of mind over matter and a jolly outstanding one too.'

'No, we mustn't tell Girdhari Ram,' Ramdyaal Singh agreed. 'Even although it was his own bowling that did the trick and not the *jadoo* of the ball—that lost ball which never was lost at all.'

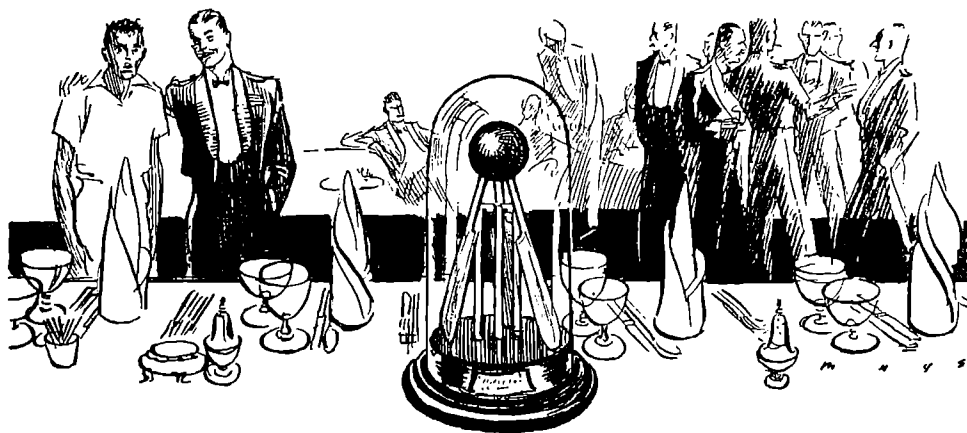

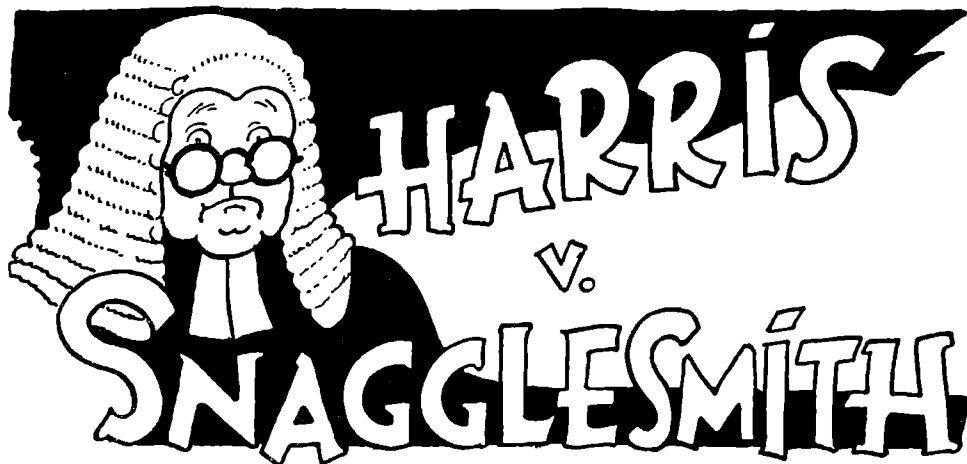

HARRIS v. SNAGGLES SMITH

A humorous trial scene

By R. J. MCGREGOR

PEOPLE IN THE PLAY

A Court Usher.

The Judge.

Clerk of the Court.

A Jury of twelve persons.

JOHN SNAGGLES SMITH, *a baker.*

Counsel for the Prosecution.

Counsel for the Defence.

PERCY HARRIS, *a small boy.*

Policemen, solicitors, reporters, members of the public, a baker's boy.

SCENE. *A court of justice. When the curtain rises the jury are already in their places, on the left of the stage. The high seat for the JUDGE is, at the moment, empty. In front of, and below it, sits the CLERK OF THE COURT, fiddling fussily with many papers. To the left of the JUDGE'S seat, and between it and the jury, is the witness-box. In front is the dock. Between the dock and the CLERK are seats for COUNSEL. On the right of the stage is an entrance which is guarded by a policeman. Reporters have a bench below and in front of the jury. There is a door behind and to the right of the JUDGE'S seat.*

COUNSEL and solicitors are whispering, nodding, and laughing together. The jury, a mixed one, is looking very full of itself.

Through the door at the back the COURT USHER enters.

USHER. *Silence in court! All stand, please.*

The JUDGE enters and bows to COUNSEL, jury, and public in turn.

The CLERK OF THE COURT stands on his chair to bow to the JUDGE, fearing he will not otherwise be seen.

The JUDGE takes his seat, puts on huge spectacles, and looks over the top of them at various parts of the court.

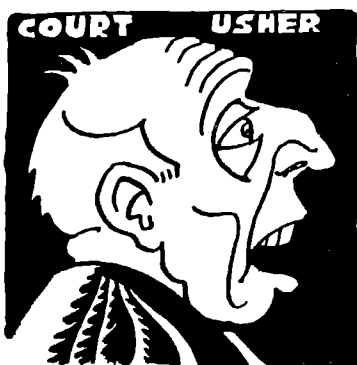

USHER. Be seated. Silence in court.

Every one sits, except the USHER himself and the police. The CLERK again stands on his chair and puts papers in front of the JUDGE. His Lordship takes off his glasses and peers at them. Then he coughs throatily.

JUDGE. Has the jury been sworn?

CLERK (*again mounting his chair and bobbing to the JUDGE*). Yes, m'lud.

JUDGE. Let me see. The first case is—a——

CLERK (*once more mounting on his perch*). It is the case, m'lud, of Percy Harris, a minor, suing through his father, versus John Snagglesmith.

JUDGE. Snagglesmith! Dear me! Percy Harris, yes. H'm! What is his father's name?

CLERK. Tom Harris, m'lud.

JUDGE. Tom? Do you mean Thomas?

CLERK. I don't know, m'lud. On all the documents in the case his name is given as Tom.

ONE OF THE JURYMEN. That's right. He was christened Tom. I know him well.

JUDGE (*looking fierce*). Members of the jury may not address the court.

This is most irregular. Eh? What do you say, you know him well?

This is a most improper state of affairs. Who empanelled this jury?

CLERK (*in a great state of agitation*). M'lud, I did, but I had no idea——

JURYMEN. You needn't worry, Sir. I know Snagglesmith just as intimately.

They are both friends of mine.

COUNSEL FOR DEFENCE (*rising*). M'lud, I——

JUDGE. Well, Mr. Corder?

C.D. M'learned friend and I have both scrutinized the jury, m'lud, and we are quite satisfied.

JUDGE. So you may be, but I don't know that I am. It is an extraordinary state of affairs, a member of the jury being a personal friend of both parties.

COUNSEL FOR THE PROSECUTION. Doesn't that make him quite impartial, m'lud?

JUDGE. Eh? Well, well, have it your own way. Let us proceed. We have

a heavy list before us, and I am to be entertained—H'r'r'mp!—no matter. Proceed. (*The juryman who interrupted winks at COUNSEL, but unfortunately for him the JUDGE sees him do it.*) Please understand me, I will have no levity in this court. I am here to see that justice is meted out with impartiality. This is not the place for pantomime. Now, please.

CLERK. Call John Snagglesmith.

VOICE OUTSIDE. John Snagglesmith! John Snagglesmith!

SNAGGLESMITH *enters and is conducted to the dock by a policeman. He is an elderly man, rather seedy-looking.*

CLERK. Are you John Snagglesmith?

SNAG. Yes, Sir.

CLERK. John Snagglesmith, you are charged with that you did, on or about the thirty-first of August last sell, or cause to be sold, or did display and offer for sale, or did cause to be displayed and offered for sale a confection, to wit, a doughnut, which was entirely without its proper content, to wit, jam. Do you plead Guilty or Not guilty?

SNAG. Not guilty.

The CLERK does his climbing and bobbing act again.

JUDGE. Very well. Let the case be heard. Mr. Lachrymose.

COUNSEL FOR THE PROSECUTION *rises with papers in his hand. He does not look at them, and after a time drops them. He stands near the jury, facing them, but so that he can easily turn to the JUDGE.*

C.P. Members of the jury, you are about to try a most unusual case, I might say a unique case. My client, a schoolboy, is by the law of the land unable to bring this action except through his father. Consequently I must ask you to keep clearly in your minds that in the course of this trial the injured party is not really a grown man but a young and innocent child who is an easy prey to the scheming of an unscrupulous—

C.D. (*rising quickly*). M'lud, I protest.

JUDGE. What is it, Mr. Corder?

C.D. M'lud, with all deference I submit that m'learned friend is going beyond the bounds of latitude allowed in referring to my client as unscrupulous.



JUDGE. I agree. Mr. Lachrymose, will you please withdraw that?

C.P. (*bowing*). M'lud, I crave the Court's pardon. I allowed my natural indignation at the unscrup—

JUDGE. Please be careful.

C.P. (*to jury*). The point I was trying to make, members of the jury, when m'learned friend interrupted, was that the injured party in this action is in reality an innocent child.

C.D. (*again rising*). M'lud, with apologies to your lordship, I submit that the innocence of the child is merely a matter of supposition.

C.P. A quibble, if I may say so, m'lud.

JUDGE. I don't agree. Counsel on both sides must bear in mind that the boy does not enter into the case, except, possibly, as a witness. Please continue, Mr. Lachrymose.

C.P. I think the jury will understand. Now, members of the jury, you have been chosen as those well fitted by your sagacity, your common sense, your sense of fairness, your qualification as respected and responsible citizens, your—your—your all-round ability to listen to the evidence that is put before you and to sift the grain of truth from the chaff of circumlocution.

JURYMEN. Use words we can understand, please.

Tittering in the court.

USHER. Silence!

JUDGE. I will have the court cleared if this uproar continues. Members of the jury, I must insist that you listen with no attempt at interruption. I have large powers to commit you for contempt of court if my orders are not obeyed. Please get on, Mr. Lachrymose.

C.P. The case briefly is this. I am going to bring witnesses of the highest integrity to prove that the defendant in this action has been in the habit of selling—

C.D. M'lud, this is too much. I beg your lordship to restrain m'learned friend. There is nothing in the charge about habit.

JUDGE (*looking over papers*). No, the charge specifies a particular occasion. There must be nothing said about habit.



C.P. I bow to your lordship's ruling. I hope to prove to your entire satisfaction that on the material date the defendant did actually sell a doughnut which contained no jam. I need not, I will not, insult you by saying how horrible a thing that was.

JUDGE. One moment, Mr. Lachrymose. Before you proceed with your opening speech I think it would be as well if the jury were informed exactly what is a doughnut.

C.P. Surely, m'lud, every one knows that!

JUDGE. You have no right to assume it. I may not, for one.

There is a gasp throughout the court.

C.P. A doughnut, m'lud, is a confection.

JUDGE. No doubt, but there are confections and confections. We had better have the dictionary definition. Is there a dictionary in court?

The JUDGE, COUNSEL, the CLERK, all look around hopefully. A jury-man pulls a small and battered dictionary from his pocket. It is seized by a policeman, handed to COUNSEL, then to the CLERK, and so to the JUDGE.

JUDGE (*turning over pages*). How do you spell the word?

CLERK. I'm not quite sure, m'lud.

SMALL BOY IN COURT (*in a squeaky voice*). D, o, u, g, h, n, u, t.

JUDGE (*looking over his glasses*). Do you think the boy is right?

CLERK. We can but try, m'lud.

JUDGE. Yes, here it is. Listen, members of the jury. Doughnut, a cake made of d.—made of d.?—Oh! I see. A cake made of dough, containing jam, sweetened and fried. There you are. Now the court knows what is the nature of the confection in question.

He continues to turn over pages of the dictionary.

C.P. When I have brought witnesses to prove that the defendant did indeed sell doughnuts with no jaminem, I mean jam in them, you will have no difficulty in finding for my client, with appropriate damages. I will now call my first witness, Percy Harris.

POLICEMAN. Percy Harris!

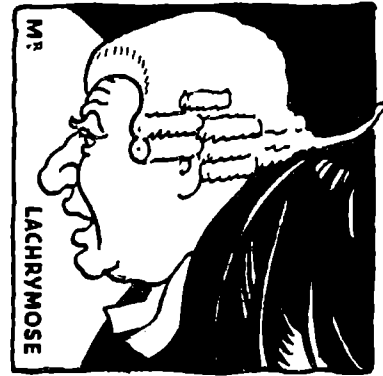

PERCY (*running forward*). All right, you needn't shout. I'm ready.

PERCY is put in the witness-box.

POLICEMAN. Take hold of this and say these words after me.

JUDGE. Just read the oath over to him and make sure that he understands it.

The policeman mumbles very rapidly a few words of which only I swear can be heard.

PERCY. Don't I have to kiss the book?

JUDGE. Do you understand that you are now bound to tell the truth?

PERCY. I always do.

JUDGE. Very well then.

C.P. Now then, is your name Percy Harris?

PERCY. You know very well it is. When I was in your office yesterday——

C.P. You are not allowed to do anything except answer my questions.

Now, tell me, did you, on August the thirty-first last, go to the shop of John Snagglesmith?

PERCY. Of course I did.

C.P. For what purpose?

PERCY. To buy tuck.

JUDGE. To buy what?

C.P. Tuck, m'lud, a child's name for—for——

PERCY. Good things to eat. Sweets and things like that.

JUDGE. But surely the case concerns a doughnut.

C.P. Yes, m'lud.

JUDGE. Oh, I see! He went to buy tuck but he changed his mind and bought a doughnut. Is that it?

PERCY. A doughnut *is* tuck, me lud.

JUDGE. I fear—Never mind, proceed with the evidence.

C.P. What was the nature of the tuck you decided to buy, which, indeed, you did buy?

PERCY. Two doughnuts.

C.D. M'lud, there is nothing in the charge about two doughnuts.

JUDGE. I think, Mr. Corder, the point is immaterial. Even if he did buy two doughnuts we are only concerned with one of them.

C.D. Very good, m'lud.

C.P. All right, you bought two doughnuts. For what purpose?

PERCY. What d'you think? To throw at my Aunt Sally.

Loud laughter in the court.

USHER. Silence!

JUDGE. I am becoming a little confused by this dragging in of immaterial names. Have you an Aunt Sally?

C.P. I apologise for the witness, m'lud. It was unseemly merriment on his part.

JUDGE. Then I must insist that you restrain your witness.

C.P. Did you eat the doughnuts?

PERCY. I ate one of them.

C.P. Only one. Why didn't you eat both?

PERCY. Because they were frauds.

C.P. What precisely do you mean by that? Tell the jury.

Percy. There was no jaminem.

C.P. There was no—jam—in—them. You are sure of that?

PERCY. Positive.

C.P. Thank you. (*Turning to COUNSEL FOR THE DEFENCE.*) If m'learned friend—

C.D. (*rising slowly, and smiling at the witness*). Don't go, Percy. I have now to ask you a few questions. This is what is called cross-examination.

PERCY. I know. You are going to try to make me contradict myself. He said you would.

C.D. Dear me, no! An intelligent boy like you—

PERCY. Yes, and he told me you would say that, too.

C.D. M'lud!

JUDGE (*looking up from dictionary*). Eh?

C.D. This witness is being facetious.

JUDGE. He doesn't know what that means. Here, pass him the dictionary.

No, later perhaps. Answer counsel's questions, boy. Don't waste the time of the court.

PERCY. He hasn't asked me any yet.

C.D. I will. Now pay particular notice to this question. Did you eat both doughnuts?

PERCY. No, I did not.

C.D. Why not?

PERCY. I've told you once.

C.D. You told m'learned friend, but I want

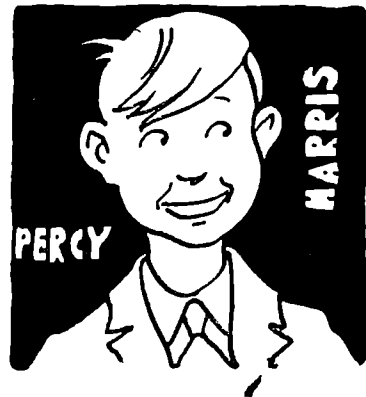

you to tell the judge and the jury once more. Why did you not eat both?

PERCY. Because there was no—jam—in—them.

C.D. Do you insist upon that? That there was no—jam—in—them.

PERCY. I do.

C.D. How do you know?

PERCY. Because I ate one of them.

C.D. Ha! You ate one only?

PERCY. That's right. I couldn't stomach the other one.

JUDGE. Couldn't what? Never mind, let it pass.

C.D. If you only ate one of them how do you know there was no jam in the other one?

PERCY. Because I do.

C.D. That is no answer.

PERCY. '—thou unfeeling man'. Shakespeare, *Merchant of Venice*.

C.D. (*storming*). Answer me, sir!

PERCY. I've forgotten what the question was.

C.D. I will repeat it. If you only ate one, how do you know there was no jam in the other one?

PERCY. Because old Snagglesmith is too mean to put any.

C.D. If you had bitten into the other one might you not have found some jam?

PERCY. My father discourages gambling.

C.D. That will do. You may stand down.

PERCY *goes back to his seat, grinning.*

C.P. That concludes my case, m'lud.

JUDGE. Mr. Corder, have you any witnesses to call?

C.D. Only one, m'lud.

JUDGE. Very well.

C.D. (*turning to jury*). Members of the jury, m'learned friend has tried to show that my client has been guilty of the sale of a doughnut which contained no jam. He does not suggest that there was any systematic omission of jam from the doughnuts, but he does say that on August the thirty-first last my client sold a doughnut, one doughnut, which was without jam. In order to prove his case he brings one witness only, a schoolboy, and you have seen for yourselves what a dreadful figure he cut.

VOICE FROM THE BACK. That's my Percy you're talking about.

USHER. Silence!

VOICE. Silence yourself. I won't have my Percy——

A chorus of hisses and a fierce look from the JUDGE silences the voice.

C.D. The boy admits that he only sampled one doughnut. He did not even take a bite at the other. Yet he declares that he is sure there couldn't have been any in the second one. A witness who will declare the non-existence of jam in a doughnut when he has only seen the outside cannot be relied upon at all. I submit that the boy was so greedy that he wolfed down the one doughnut without even knowing what he was eating. I shall bring a witness to prove that there was jam there. John Snagglesmith.

SNAGGLESMITH is conducted from the dock to the witness-box and is sworn in the same mumbling fashion.

C.D. Now, sir, is your name John Snagglesmith?

SNAG. It is.

C.D. How old are you?

SNAG. Sixty-five.

C.D. And what is your business?

SNAG. Baker and confectioner.

C.D. Do you make and sell doughnuts?

SNAG. I do.

C.D. Did you sell two doughnuts to the plaintiff on August the thirty-first last?

SNAG. No.

C.D. You didn't?

SNAG. No, but my assistant might have.

C.D. Doughnuts were sold in your shop that day?

SNAG. They are sold there every day.

C.D. And do you always put jam in them?

SNAG. Certainly.

C.D. Then any doughnut sold in your shop on August the thirty-first must have had jam in it?

SNAG. It must.

C.D. Do you make the doughnuts yourself?

SNAG. Always.

C.D. And you are particular to see that they all contain jam?



SNAG. I am.

C.D. You don't think that by inadvertence you omitted the jam?

SNAG. By what?

C.D. By accident?

SNAG. No, sir.

JUDGE. Tell me—I have always wanted to know—how do you put the jam in a doughnut? Do you inject it?

SNAG. No, your lordship.

JUDGE. You don't pump it in?

SNAG. No, sir. In the first place the doughnut is just a thick and flat piece of dough. Then the jam is laid on it and the dough is wrapped round it and shaped into its proper shape.

JUDGE. Dear me! Yet the thing never seems to have a join in it.

C.D. I think that is all unless m'learned friend wishes to cross-examine.

C.P. (*rising*). Now, Mr. Snagglethwaite—

SNAG. SnaggleSmith, if you please, sir.

C.P. Pardon, yes. Do you declare it is impossible for any doughnut to be sold in your shop with the jam omitted?

SNAG. I don't say it is impossible.

C.P. Ha! Members of the jury will take notice of that. Your system is not fool-proof?

SNAG. Perhaps not, but on that particular occasion I am positive I remembered the jam in each one.

C.P. Your memory is a very good one?

SNAG. Where my business is concerned, yes.

C.P. Can you tell us, Mr. Snagglewit—I beg your pardon—can you tell us exactly how many doughnuts you sold on the date in question?

SNAG. All of them.

C.P. Yes, but how *many*?

SNAG. Between eighty and a hundred.

C.P. Come, come! Can't you tell us nearer than that?

SNAG. Might have been ninety.

C.P. You can't swear to the precise number?

SNAG. No.

C.P. Yet where your business is concerned your memory is a very good one. I think the jury will draw their own conclusions.

C.P. (*after a pause*). One more question, Mr. Snagglebotham.

JUDGE. The defendant has a right to be called by his proper name, Mr. Lachrymose.

C.P. As your lordship pleases. Now, Mr. Snag—(*he turns over papers*) Mr. Snagglesmith, do you suggest that my client was mistaken in thinking there was no jam in the doughnut he bought and ate?

SNAG. The greedy little pig probably ate it so fast that he didn't know what he was eating.

C.P. You have no right to make assertions of that sort. The members of the jury have seen the child and by no stretch of imagination can he be likened to a pig. I put it to you that you have made so many doughnuts in your time—you can't remember how many on this one occasion—that you have grown careless about the jam.

SNAG. Oh no, it becomes a habit.

C.P. In fact, you put in the jam unconsciously: without taking particular notice.

SNAG. That's right.

COUNSEL FOR THE PROSECUTION *smiles at this damaging admission.*

COUNSEL FOR THE DEFENCE *holds his head between his hands.*

C.P. Thank you, Mr.—uh——

SNAG. *stands down and COUNSEL turns to address the jury once more.*

C.P. Members of the jury, I think you have heard enough. Your natural intelligence will show you how to give your verdict. You have seen the innocent boy who has been defrauded out of the main enjoyment of his pennyworth of doughnut. Can you doubt for one moment that the reason for his refusal to eat the second piece of tuck was that the first was deficient in just that which makes a doughnut what it is, namely, the jam? The defendant has admitted that habit has made him careless. He admits that his memory is failing—(COUNSEL FOR THE DEFENCE *half rises in his seat, but says nothing and sits down again.*)—m'learned friend may have some observations to make on that point later, but I want you to bear in mind that the defendant did indeed admit that he cannot remember——

JUDGE. One moment, Mr. Lachrymose. Are you likely to be long? I should like to finish this case before lunch.

C.P. I have almost finished, m'lud. Members of the jury, I ask you to find the defendant guilty of fraudulently selling a doughnut without jam in it: selling to a boy, a young child who is not in a position to defend himself, and has been cruelly wronged by the fact that he did not receive proper value for his meagre pocket money. I leave my case with you, trusting to your wisdom and sense of that fair play which is the right of every Englishman.

COUNSEL *sits down, looking very satisfied. Defending COUNSEL at once rises.*

C.D. Members of the jury, I have now the right to address you before his lordship sums up. As m'learned friend has so eloquently stated (C.P. *stands up and bows to C.D.*) we can trust your wisdom to see that justice is done. But there are one or two points that I should like to fix in your mind. (*The JUDGE appears to have gone to sleep.*) First, I deny that my client is suffering from a failing memory. You saw him in the witness-box, you see him there now. A fine specimen of vigorous manhood, with all his powers in their prime. It is ridiculous to suggest that he can't remember whether he put any jam in the doughnut in question. The man is an artist in his profession. It is the pride of his life. (*He pauses and looks over his papers.*) Now about the boy. You notice that the prosecution only brings one witness. His lordship will have something to say about that.

JUDGE (*sitting up*). Eh? Oh, yes.

He shuts his eyes again.

C.D. Can you believe that the boy knew what he was eating? The fact that he threw away the second doughnut is evidence enough of his greed. He bought more than he could eat. No, members of the jury, it is plain that this prosecution has nothing to stand upon. It is obvious that the boy was telling——

C.P. (*jumping up quickly*). M'lud, I protest.

C.D. I haven't said it yet.

JUDGE. Said what?

C.D. I was going to say the boy was telling what he believed to be the truth, but m'learned friend objects, so I will withdraw that. I think the case is proved beyond any shadow of doubt that my client did indeed put jam in all his doughnuts, but that the boy bolted the one he first chose and therefore didn't know whether there was any jam there or not. I await your verdict with complete confidence. Thank you, m'lud.

The JUDGE heaves himself up in his chair, sighs loudly, polishes his glasses, scratches his ear with the end of his pen, and then turns to the jury.

JUDGE. Members of the jury. You have heard the evidence on both sides of this unusual case, but as I see it, you have nothing to decide, for the simple reason that the defendant has no case to answer. (*Every one in court looks amazed, and there is a hum of conversation.*) As I see it the whole case turns on the definition of a doughnut. I read it to you from the dictionary, but it would be as well if you read it for yourselves. Let the jury study the dictionary definition.

The dictionary is passed to the jury. While they are looking at it counsel whisper together. The JUDGE taps on his desk to attract the attention of the CLERK, who mounts his chair again. The JUDGE says something to him, and he bows. He climbs down and scribbles a short note which is passed over to COUNSEL FOR THE DEFENCE. COUNSEL turns and speaks to SNAGGLESMITH, who nods and smiles.

JUDGE. Have you read it, members of the jury? (*There are mutterings of assent from the jury.*) Very well. There are two, and only two, possible answers to this charge. Either there was jam in the doughnut or there wasn't. Do I make myself clear?

FOREMAN. Quite, m'lud.

JUDGE. Thank you. Let us take the first case: that there was jam in the doughnut. Well, in that case the defendant has nothing to answer, and the prosecution fails. (*COUNSEL FOR THE DEFENCE nods and smiles back at his client. SNAGGLESMITH is looking bewildered.*) Now for the second case: that there was no jam in this confection. Well, as I read the law, and the dictionary, if it had no jam *it wasn't a doughnut at all!*

Consternation in the court, followed by some applause.

USHER. Silence.

JUDGE. The dictionary is perfectly clear about that: the definition says 'containing jam'. Well, if it didn't contain any jam how could it be a doughnut? It seems to me that either the defendant sold a genuine doughnut, which would automatically contain jam, or he sold a different kind of—a—tuck, which, being without jam, wasn't a doughnut. I feel that it would be a pleasant ending to this unhappy case if Mr. Snagglesmith were to provide the court with a light lunch of his own particular doughnuts.

FOREMAN. Including the jury, m'lud?

JUDGE. Certainly.

JURYMAN. With jaminem?

JUDGE. Haven't I made it clear that they only become doughnuts if they do contain jam?

A boy enters with a tray of doughnuts. It is passed to the JUDGE, who takes the biggest and takes a huge bite. In a few seconds COUNSEL, jury, solicitors, and witnesses are all munching. The CLERK mounts on his chair and seizes a second doughnut that the JUDGE has put on his desk, and bites it as

THE CURTAIN FALLS.

