

CONFERENCE VISUAL IDENTITY STANDARDS

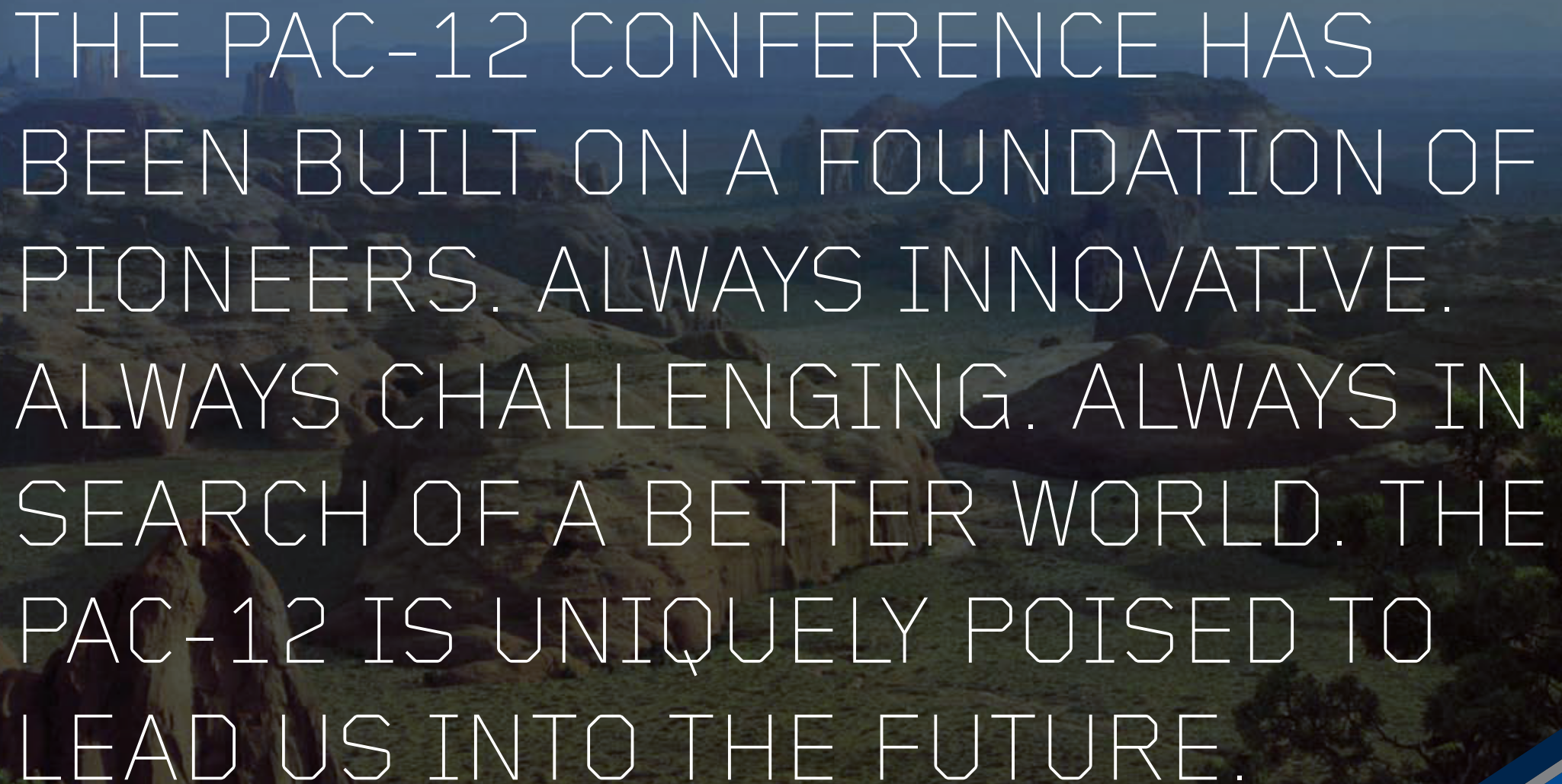

THE PAC-12 CONFERENCE STYLE GUIDE // BEGINNING 2011-12 ACADEMIC YEAR

The background of the image is a scenic landscape featuring a wide river or valley in the foreground, with rolling hills and mountains in the distance under a clear sky. The text is overlaid in a white, outlined, sans-serif font. In the bottom right corner, there is a decorative graphic consisting of two parallel diagonal lines, one blue and one white, pointing towards the bottom right.

THE PAC-12 CONFERENCE HAS
BEEN BUILT ON A FOUNDATION OF
PIONEERS. ALWAYS INNOVATIVE.
ALWAYS CHALLENGING. ALWAYS IN
SEARCH OF A BETTER WORLD. THE
PAC-12 IS UNIQUELY POISED TO
LEAD US INTO THE FUTURE.

TABLE OF CONTENTS

THE MARKS	5
.....	
An introduction to the Pac-12 brand mark, variations and basic outline of proper usage.	
THE COLORS	11
.....	
A list of the colors of the Pac-12 for both screen and print.	
RESTRICTED MARKS	12
.....	
A list of marks restricted from use.	
RESTRICTED USAGE	13
.....	
A list of restricted uses of the Pac-12 shield.	
TYPOGRAPHY	14
.....	
An overview of the typographic system of the Pac-12.	
PHOTOGRAPHY	19
.....	
Pac-12 photography style and cropping guidelines.	
DESIGN ELEMENTS	20
.....	
Overview and examples of the use of the supporting graphics available as part of the Pac-12 designer toolkit.	
MEDIA BACKDROPS	24
.....	
Media backdrop layout requirements.	
INSTITUTIONAL ASSETS	27
.....	
Pac-12 collateral asset guidelines.	
UNIFORMS	30
.....	
Required logo usage on uniforms.	
FACILITIES	51
.....	
Required logo usage by facility type.	

PAC-12 // CONFERENCE VISUAL IDENTITY STANDARDS



THE MARKS

INSPIRATION

SHIELD

The shield shape conveys excellence in academics and athletics. It is unique amongst major college conferences.

ELEMENTS

The wave evokes a sense of movement, while the mountain represents “rising”. Both elements conjure up an image of the west.



LETTERFORMS

The typography is handcrafted to reflect a modern edge, west coast feel and to ensure legibility from a distance.

COLOR

The blue gradient in the mark is designed to suggest the deep underwater blues of the Pacific Ocean.

THE MARKS

THE BREAKDOWN

In an effort to build flexibility into the brand, the Pac-12 mark has been designed to break down into three purpose-built marks.

PRIMARY



INSTITUTIONAL



REDUCED
UNIFORM / EQUIPMENT



HORIZONTAL



HORIZONTAL
INSTITUTIONAL



THE MARKS

THE PRIMARY MARK

In an effort to build brand consistency, the primary Pac-12 mark (shield with the wave and mountain) shall be used on all institutional elements other than uniforms, equipment and apparel.

To determine the appropriate primary mark color scheme for a given element, please refer to the guidelines shown here.

For each color scheme, two versions of the primary mark are available for use: one for use on white / light backgrounds and one for use on black / dark backgrounds.

Pac-12 Blue Fade Mark

use on white / light backgrounds



use on black / dark backgrounds

Uses :

Pac-12 Championships

All general marketing elements outside of the game day experience including:

Media Guides

Institutional Athletic Websites

Institutional Marketing Communications

Team Posters

Television & Media Graphics

Institutional Colors

use on white / light backgrounds



use on black / dark backgrounds

Uses :

All elements of the game day experience including:

Playing Surface

Venue Signage

Video Boards

Press Credentials

Media Backdrops

Tickets

Game Programs

Promotional Game Day Materials

Black & White

use on white / light backgrounds



use on black / dark backgrounds

Uses :

Limited to black and white printed elements

THE MARKS

THE HORIZONTAL MARK

The Pac-12 horizontal mark shall only be used on elements approved by or originating from the Conference office.

In Pac-12 blue, black and white and in institutional colors, two versions of the horizontal mark are available for use: one for use on white / light backgrounds and one for use on black / dark backgrounds.

Please note that there is a color shift in the blue when the horizontal mark is used on a black / dark background. On a white / light background the "12" and "Conference" are PMS 662 c and on a black / dark background the "12" and "Conference" are PMS 2935 c.

Pac-12 Blue



Uses :

- Television & Media Graphics
- Pac-12 Website
- Other Approved Elements

Black & White



Uses :

- Approved Black & White Printed Elements

Institutional Colors



THE MARKS

MARK CLEAR SPACE

The area of isolation around the outer edges of the shield is crucial to ensure proper visibility.

Please ensure that page edges, borders and other design elements fall OUTSIDE of the "isolation zone".

The height and width of the isolation zone is equal to the height of the "1" (from the "12") for the primary, reduced and horizontal mark.

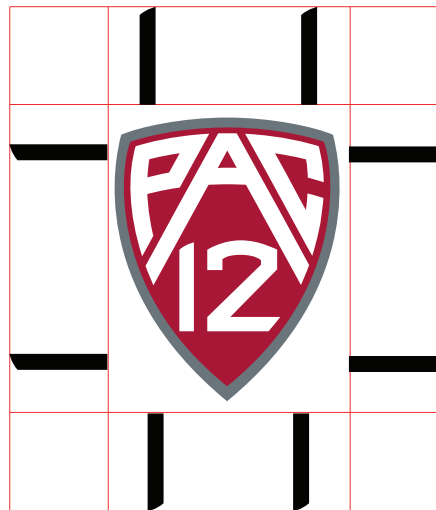

THE MARKS

MINIMUM MARK SIZE

The minimum size for the primary Pac-12 mark (with the wave and mountain) shall be no less than .5" wide.

The reduced mark is designed exclusively for institutional uniforms, equipment and apparel. It shall be no smaller than 1.25" wide.

The minimum size for the horizontal mark shall be no less than 1" wide.

There are no restrictions to how large any of these marks may appear.

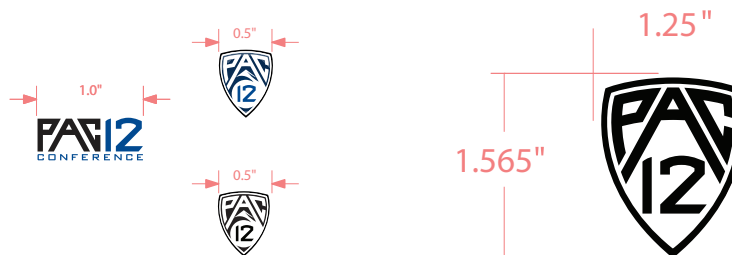

THE COLORS

THE COLORS OF THE PAC-12

The colors of the Pac-12 mark are inspired by the deep blues of the Pacific Ocean. In order to maintain a uniform brand identity, it is vital that great care is taken in utilizing the proper Conference color palette.

For different applications, the logo colors are implemented in the respective color systems. For print, there are Pantone spot colors and CMYK; and for electronic media in RGB (screen) and hex code (Web). For other applications (e.g., silk screening of fabrics), the Pantone colors can be used for comparison.

MAIN COLORS



PMS 662 c PMS 5395 c PMS 2935 c Rich Black

C=100	C=100	C=100	C=70
M=71	M=44	M=46	M=30
Y=0	Y=0	Y=0	Y=30
K=18	K=76	K=0	K=100

R=0	R=0	R=0	R=0	R=214	R=161	R=229
G=75	G=39	G=118	G=0	G=224	G=161	G=197
B=145	B=76	B=192	B=7	B=61	B=164	B=187

L=31	L=15	L=47	L=0	L=86	L=66	L=66
A=2	A=-1	A=7	A=0	A=-18	A=0	A=0
B=-45	B=-27	B=-47	B=-9	B=72	B=-2	B=0

HEX = 004B91	HEX = 00274D	HEX = 0076C0	HEX = 000007	HEX = D6E03D	HEX = A1A1A4	HEX = D3C4A
--------------	--------------	--------------	--------------	--------------	--------------	-------------

ACCENT COLORS



PMS 381 c Cool Grey 8 c PMS 4745 c

C=20	C=0	C=0
M=0	M=1	M=17
Y=91	Y=0	Y=18
K=0	K=43	K=10

RESTRICTED MARKS

BRANDING IDENTITY

The use of old Pac-10 Conference marks is STRICTLY PROHIBITED after July 1, 2011. The new mark can be used prior to this date for production of materials that will be publicly available after March 16, 2011.

Please see the included examples of prohibited marks.



RESTRICTED USAGE

BRANDING IDENTITY

Variations of the Pac-12 mark outside of the institution-specific color options included in this guide are not permitted. Any variation will compromise the integrity and unifying function of the Pac-12 brand.

Please see the included examples of prohibited variations.



Do not stretch



Do not outline



Do not enclose within a shape



Do not screen



Do not rotate

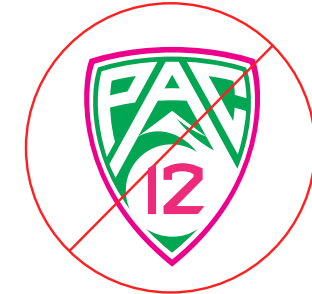

Do not re-color



Do not run text or graphics over logo

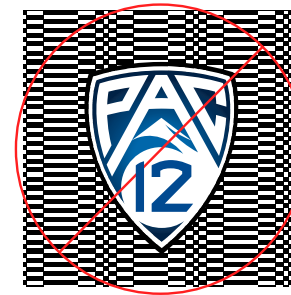

Do not use on distracting background

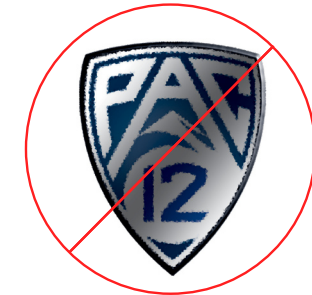

Do not use special effects

TYPOGRAPHY

BRAND TYPE

All typographic specifications indicated in this manual for point sizes, tracking and leading are based on InDesign™ and the fonts used specifically for the Pac-12.

The corporate font is Trade Gothic. It is characterized by its clarity and a modern look, and it is easy to read. Trade Gothic should be used for long text blocks. The array of available faces makes it possible to create individual designs for a wide variety of content, while still ensuring a uniform, consistent image.

To support this image, the italic faces of the Trade Gothic font family are excluded from use in any Pac-12 corporate design.

The Trade Gothic font family is complimented by the serif font Clarendon Light. Clarendon is also very easy to read and adds a distinctly 'West' feel. Text blocks should NOT be set in Clarendon Light or Foundry Gridnik.

To allow the designer flexibility, Foundry Gridnik is included as an alternate headline font. Opti Althea is similar to the shield numerals, and may be used for page numbers as demonstrated in this document.

Note: the unauthorized distribution of fonts is unlawful.

MAIN TYPEFACES

Trade Gothic Light

abcdefghijklmnopqrstuvwxy ABCDEFGHIJKLMNOPQRSTUVWXYZ
0123456789

Trade Gothic Medium

abcdefghijklmnopqrstuvwxy ABCDEFGHIJKLMNOPQRSTUVWXYZ
0123456789

Trade Gothic Bold #2

abcdefghijklmnopqrstuvwxy ABCDEFGHIJKLMNOPQRSTUVWXYZ
0123456789

TRADE GOTHIC LH
EXTENDED

abcdefghijklmnopqrstuvwxy
ABCDEFGHIJKLMNOPQRSTUVWXYZ 0123456789

TRADE GOTHIC LH
EXTENDED

abcdefghijklmnopqrstuvwxy
ABCDEFGHIJKLMNOPQRSTUVWXYZ 0123456789

SUPPORT TYPEFACES

Clarendon Light

abcdefghijklmnopqrstuvwxy
ABCDEFGHIJKLMNOPQRSTUVWXYZ
0123456789

FOUNDRY GRIDNIK

abcdefghijklmnopqrstuvwxy
ABCDEFGHIJKLMNOPQRSTUVWXYZ
0123456789

Opti Althea

abcdefghijklmnopqrstuvwxy
ABCDEFGHIJKLMNOPQRSTUVWXYZ
0123456789

TYPOGRAPHY

HEADLINE TYPE

Headlines are primarily set in Trade Gothic but may be set in Foundry Gridnik if a more modern look is desired.

Trade Gothic Bold LH Extended or Foundry Gridnik in black, 90% black, reverse white or in the main Conference colors.

The font size in each case depends upon the overall format of the print medium. Minimum size of headlines when printing on letter formats

(Example A):

18 pt tracking +4, 23 pt leading

(Example B):

18 pt tracking +4, 22 pt leading

HEADLINES

Trade Gothic Bold #2

A.

**THE PAC-12 WAS FOUNDED
IN PORTLAND, OR.**

**THE PAC-12 WAS FOUNDED
IN PORTLAND, OR.**

**THE PAC-12 WAS FOUNDED
IN PORTLAND, OR.**

ALTERNATE HEADLINE

FOUNDRY GRIDNIK

B.

THE PAC-12 WAS FOUNDED
IN PORTLAND, OR.

THE PAC-12 WAS FOUNDED
IN PORTLAND, OR.

THE PAC-12 WAS FOUNDED
IN PORTLAND, OR.

TYPOGRAPHY

INTRO / COPY HEAD TYPE

For copy heads, the preferred font face is Trade Gothic Bold #2 at 9 pt with 12.5 pt leading. This style can also be used for longer passages of introductory text.

Short passages of introductory text in the copy head style can be set in black, 90% black as well as the primary or accent colors.

It is important to ensure that the overall impression of a page does not become multi-colored, and that the selected color is used consistently. In addition to the color, the styles of introductory text can also be modified (Example A).

When a paragraph begins with a copy head, it is separated from the preceding body copy by a blank line. Body copy follows the copy head, but without the insertion of an additional blank line. The copy head may be set in any desired color, but must be used consistently throughout a print medium (Example B).

HEADLINES

Trade Gothic Bold #2

Dummy text to illustrate the appearance of a copy head: Trade Gothic#2 Bold, 9 pt, tracking +4, 12.5 pt leading, left justified. Si meliora dies, ut Vina, poemata Reddit, scire Velim. Chartis pretium quotus Arroget annus. Scriptor abhinc annos Centum qui decidit, inter perfectos Veteresque.

- A. **Example for use in an introduction: Si meliora dies, ut vina, poemata reddit, scire velim, chartis pretium quotus Arroget annus. Scriptor abhinc annos Centum qui decidit, inter perfectos Veteresque referri debet an inter Vilis atque novos? Excludat iurgia finis.Est vetus atque probus. Centum qui perficit annos.**

EXAMPLE FOR USE IN AN INTRODUCTION: Si meliora dies, ut vina, poemata reddit, scire velim, chartis pretium quotus Arroget annus. Scriptor abhinc annos Centum qui decidit, inter perfectos Veteresque referri debet an inter Vilis atque novos? Excludat iurgia finis.Est vetus atque probus. Centum qui perficit annos.

EXAMPLE FOR USE IN AN INTRODUCTION: Si meliora dies, ut vina, poemata reddit, scire velim, chartis pretium quotus Arroget annus. Scriptor abhinc annos Centum qui decidit, inter perfectos Veteresque referri debet an inter Vilis atque novos? Excludat iurgia finis.Est vetus atque probus. Centum qui perficit annos.

- B. **Example for use in a copy head** | Si meliora dies, ut vina, poemata reddit, scire velim, chartis pretium quotus Arroget annus. Scriptor abhinc annos Centum qui decidit, inter perfectos Veteresque referri debet an inter Vilis atque novos?

TYPOGRAPHY

BODY COPY STYLE / ACCENT TYPE

Extensive amounts of body copy, such as annual reports and image brochures, are set in Trade Gothic Medium. (Example A). Alternately, copy may be set using Trade Gothic Light (Example B).

Clarendon Light is used as an accent font. In the case where Trade Gothic and Clarendon are set on the same line, a dividing line element used in the same color of the font or an accent color is suggested.

COPY

Trade Gothic Medium

Trade Gothic Light

- A. Dummy text to illustrate the appearance of a copy head: Trade Gothic Medium, 9 pt, tracking +4, 12.5 pt leading, left justified. Si meliora dies, ut Vina, poemata Reddit, scire Velim. Chartis pretium quotus Arroget annus. Scriptor abhinc annos Centum qui decedit, inter perfectos Veteresque.
- B. Dummy text to illustrate the appearance of copy: Trade Gothic Light, 9 pt, tracking +4, 12.5 pt leading, left justified. Si meliora dies, ut Vina, poemata Reddit, scire Velim. Chartis pretium quotus Arroget annus. Scriptor abhinc annos Centum qui decedit, inter perfectos Veteresque.

EXAMPLES OF ACCENT TYPE

Track & Field | 100 yard dash

Track & Field

- ▶ 3000 m steeplechase
- ▶ Javelin
- ▶ Shotput
- ▶ Pole vault
- ▶ Discus throw

Track & Field // 100 yard dash

1. **California**
2. **USC**
3. **Oregon**
4. **Washington**
5. **Arizona**

Track & Field ▶ 100 yard dash

- California**
- USC**
- Oregon**
- Washington**
- Arizona**

TYPOGRAPHY

OTHER TYPOGRAPHIC ELEMENTS

The typographic system of the Pac-12 includes several simple additional elements to help organize information.

The first are a set of three sentence dividing elements, used when separating a copy head from copy body.

The second elements are shields for displaying page numbers. The shields should always appear in brand colors and be set in OptiAlthea.

The third set of elements are to aid the designer in the consistent layout of listed information. Bullets and row highlights should always remain in brand colors.

EXAMPLES OF ELEMENTS USED TO BREAK LINE.

Track & Field | 100 yard dash

(Element to be used in a brand accent color.)

Track & Field // 100 yard dash

(Element to be used in type color.)

Track & Field ▶ 100 yard dash

(Element to be used in brand accent color, this style recommended for web.)

EXAMPLES OF SHIELD PAGE NUMBERS.



EXAMPLES OF BULLETED, NUMBERED, AND COLORED LISTS.

Track & Field

- ▶ 3000 m steeplechase
- ▶ Javelin
- ▶ Shotput
- ▶ Pole vault
- ▶ Discus throw

1. California
2. USC
3. Oregon
4. Washington
5. Arizona

California

USC

Oregon

Washington

Arizona

(Highlighted rows must always be set on brand colors. Both a fade to 0% opacity, OR a solid bar are acceptable.)

PHOTOGRAPHY

PHOTOGRAPHIC STYLE AND FEEL

The photography should always be big and emotional. When selecting images keep in mind the Pac-12's dedication to the values of the west, innovation and excellence. All photography should look authentic, not overly effected or treated.



WEST COAST

INNOVATIVE

EXCELLENCE

CROPPING PHOTOGRAPHY

When cropping photography, find where the heart of the story and the emotion lies. Always make sure the Pac-12 athletes, students and facilities remain the heroes.



UNCROPPED

CROPPING

CROPPED

DESIGN ELEMENTS

BAND OF EXCELLENCE

The band of excellence is a design element to be used in conjunction with the main Conference mark or horizontal mark ONLY. It is designed to work at the angles shown. Do not stretch or warp the band.



Example of horizontal use

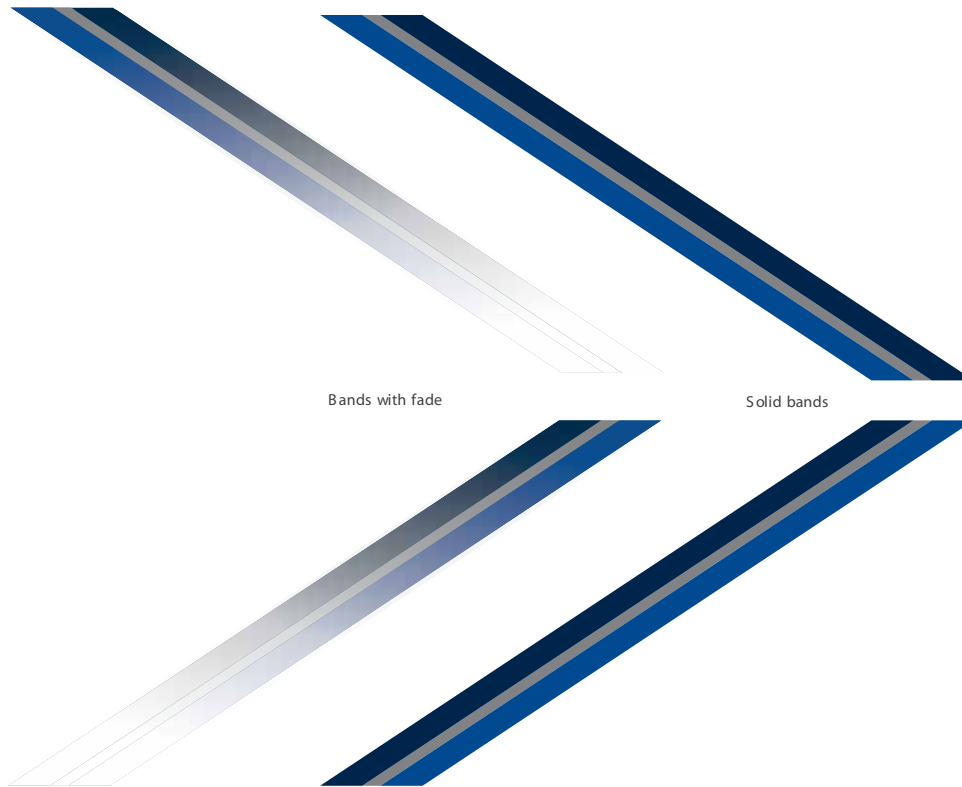

Bands with fade

Solid bands



Example of vertical use

DESIGN ELEMENTS

SHIELD OVERLAY

The shield overlay is another element in the Pac-12 designer's toolkit. As shown in the example on the right, when properly cropped and set to 4% opacity, the shield detail creates a dynamic backdrop. The designer must take care to ensure that the peak of the mountain is always centered, and the numerals or the 'A' are not showing. The crop shown is ideal, but may be altered in width slightly to accommodate your page size.

Detail of cropped area

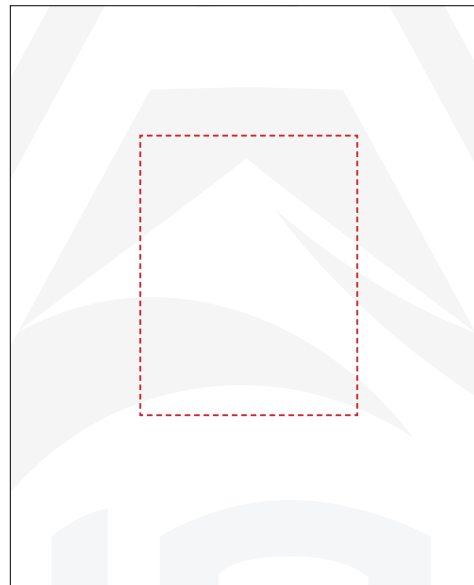

Example of shield overlay in use

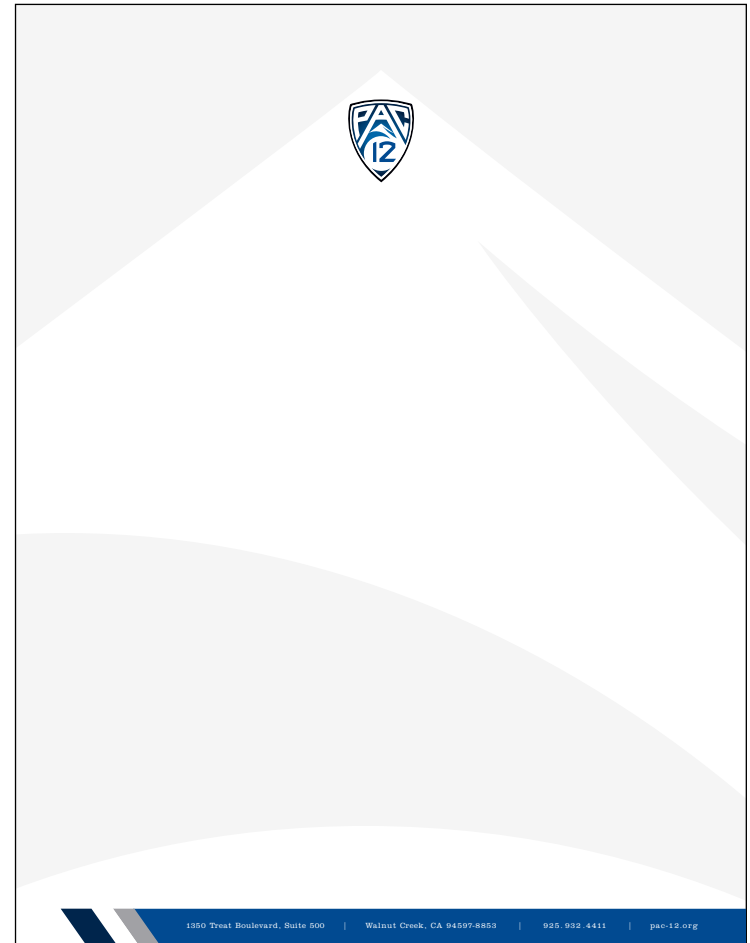

DESIGN ELEMENTS

COLOR ACCENT

The look and feel of the brand materials for the Pac-12 Conference should feel clean and modern. A second brand element that is available to the designer is the Pac-12 color accent.

The color accent is designed to be used in conjunction with the main Conference mark and the horizontal mark.

The designer may crop into the color accent up to 50% its width (example A), and may run the color accent up to 1/3 the length or width of the page. The color accent may only be positioned in the lower right corner of a design.



A.

David Smith | Director of Business Development

The Pac-12 Conference
1350 Treat Blvd., Suite 500
Walnut Creek, California 94597-8853
main. 925.932.4411
dsmith@pac-12.org

Example of horizontal use on business card

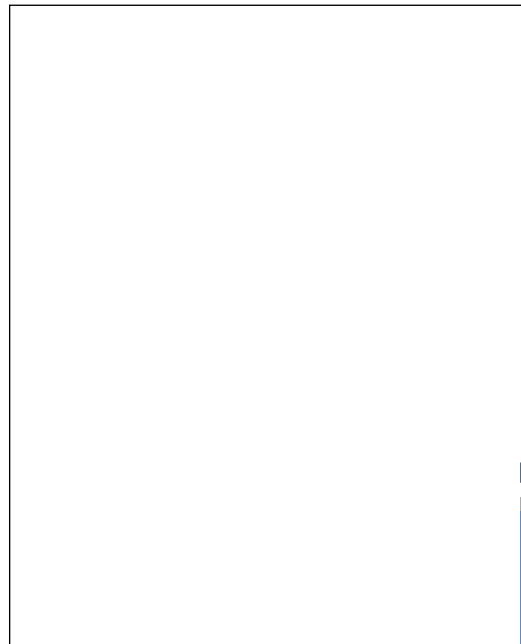

Example of vertical use on vertical layout



Example of horizontal use on horizontal banner

DESIGN ELEMENTS

SHIELD, MOUNTAIN / WAVE LINE ART USE

The shield with the mountain and wave may be used as a design element when building graphics, but great care should be taken not to sacrifice the integrity of the logo itself.

Only the white primary logo may be used when using the primary shield (with wave and mountain) as a design element. Careful consideration should be used when cropping into the shield. The ideal implementation (shown in examples on the page) is achieved when using the wave and mountain to suggest movement, or to accentuate a portion of the photograph.

Do not color the portions of the shield or add textures to it.



THE HORIZONTAL MARK LINE ART USE

The horizontal mark may also be used as a design element. The ideal implementation of the horizontal mark is to crop into the letters and numbers in a way that abstracts their legibility. The focus should be on the angles and negative space.

While you may screen the horizontal mark line art, please do not rotate, add color, textures or effects to it.

Do not color the portions of the shield or add textures to it.



MEDIA BACKDROP

LAYOUT

The following layout is required on media backdrops for Conference championships and other Conference events.



MEDIA BACKDROP

LAYOUT

The following layout is required on media backdrops for institutional events.

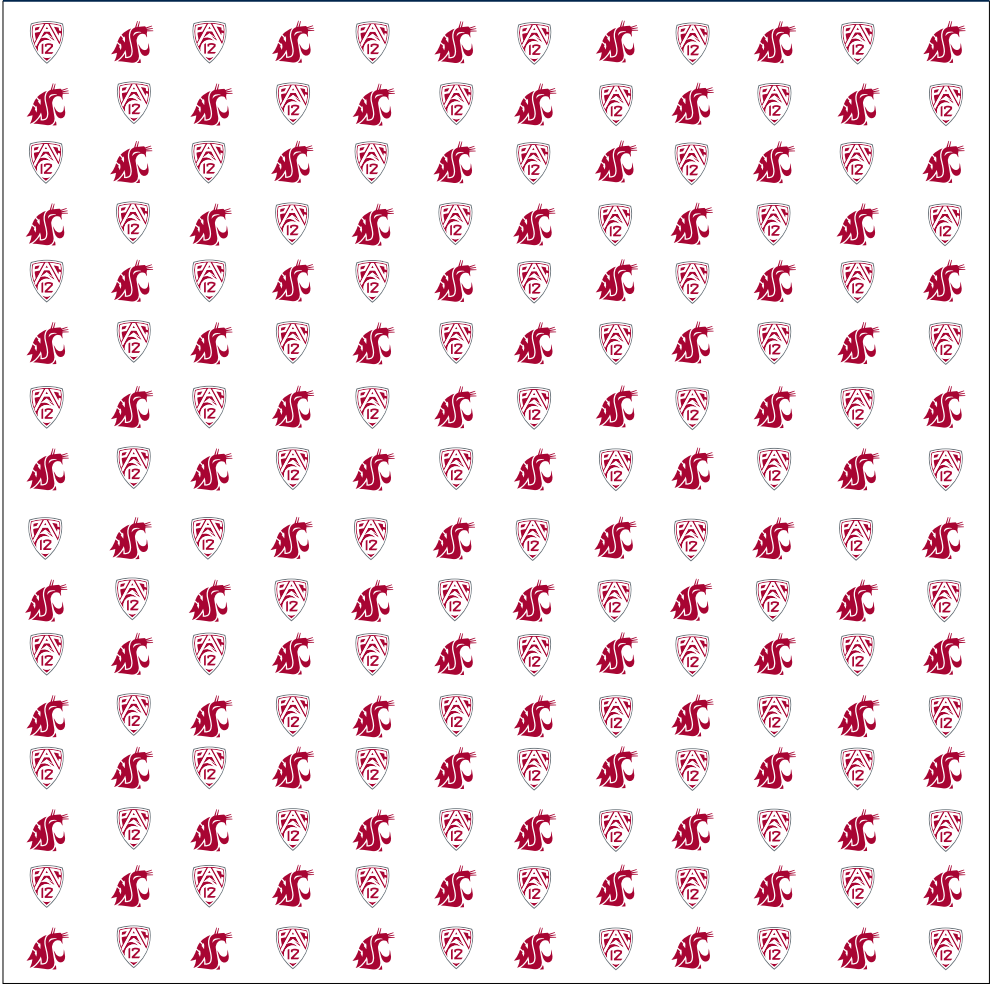

MEDIA BACKDROP

LAYOUT

The following layout is required on media backdrops for sponsored institutional events.



INSTITUTIONAL ASSETS

REQUIRED USAGE

Per the mark guidelines included in this guide, the primary Pac-12 blue fade mark must appear on all general marketing elements included on this page.

Email Marketing

Any location on the message



Print Advertisements

Any location on the advertisement

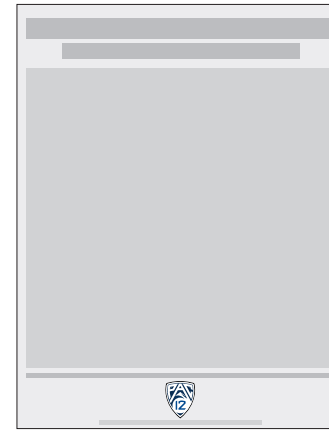

Schedule Cards

Any location on the front of card



Team Posters

Any location on the poster

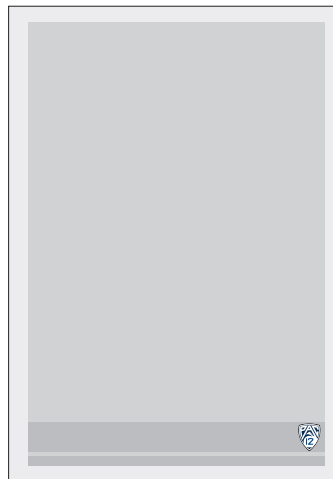

Institutional Athletic Websites

Any location on the homepage

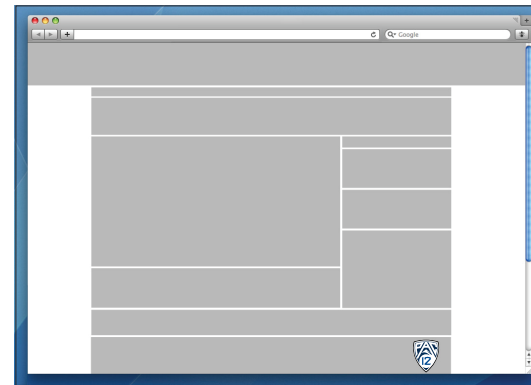

Media Guides

Per the enclosed guidelines

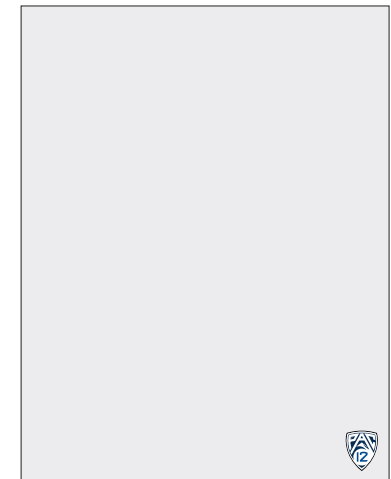

INSTITUTIONAL ASSETS

REQUIRED GAMEDAY USAGE

Per the mark guidelines included in this guide, the Pac-12 institutional mark must appear on all game day elements included on this page.

Game Programs

Any location on the outside of the front or back cover

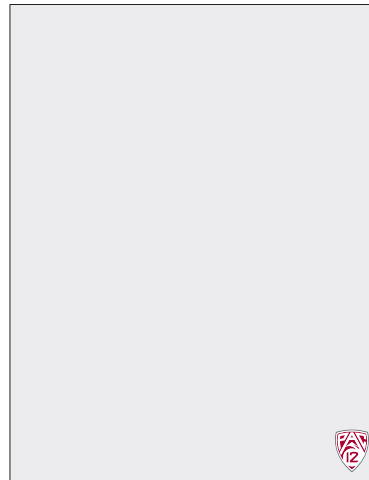

Media Backdrop

Per enclosed guidelines

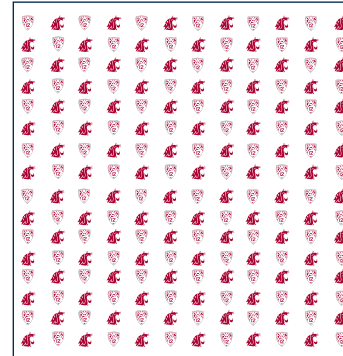

Press Credentials

Any location on the front of the credential

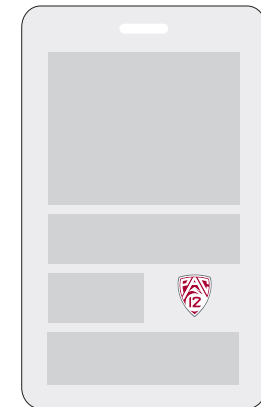

Tickets

Any location on the front or back of the ticket



INSTITUTIONAL ASSETS

RECOMMENDED USAGE

Per the mark guidelines included in this guide, the Pac-12 strongly encourages its member institutions to include the Pac-12 mark on the elements included to the right.

RECOMMENDED GAMEDAY USAGE

Per the mark guidelines included in this guide, the Pac-12 strongly encourages its member institutions to include the Pac-12 Institutional mark on the elements included to the right.

Television Spots

Any location on the spot

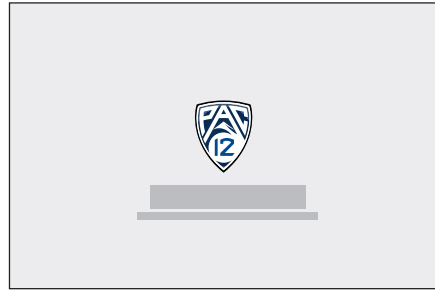

Venue Signage

Any location in the venue



Video Board

Any location on screen or board





VISUAL IDENTITY STANDARDS // UNIFORMS // WSU

REQUIRED MARK USAGE

UNIFORM REQUIREMENT ROLL-OUT

Uniform and equipment logo requirements will be rolled-out according to the schedule shown here.

SPORT	2010-11	2011-12	2012-13
Football	Required	Required	Required
Women's Volleyball	Required	Required	Required
Men's Basketball	Required	Required	Required
Women's Basketball	Required	Required	Required
Baseball	Required	Required	Required
Softball	Required	Required	Required
Men's Soccer	Optional	Required	Required
Women's Soccer	Optional	Required	Required
Men's Tennis	Optional	Required	Required
Women's Tennis	Optional	Required	Required
Track & Field	Optional	Required	Required
Swimming & Diving	Optional	Required	Required
Men's Golf	Optional	Optional	Required
Women's Golf	Optional	Optional	Required
Men's Cross Country	Optional	Optional	Required
Women's Cross Country	Optional	Optional	Required
Gymnastics	Optional	Optional	Required
Rowing	Optional	Optional	Required
Wrestling	Optional	Optional	Required

THE MARKS

THE REDUCED MARK (UNIFORMS / EQUIPMENT)

The use of the reduced Pac-12 mark (without the wave and mountain) is limited to institutional uniforms, equipment and apparel.

The displayed marks must be used on respective fabric colors as shown here.

The reduced mark is not permitted in the Pac-12 blue fade or in black and white.

Example:



Fabric Color : White

Institutional Colors



Uses :

Uniforms

Equipment

Institutional Apparel

SPECIAL INITIATIVES

BREAST CANCER AWARENESS

For special uniforms supporting breast cancer awareness, the included marks shall be used.

Mark version 1



Mark version 2



FOOTBALL

MARK USAGE

Per the included examples, the reduced mark (without the wave and mountain) shall be placed on the right chest of the uniform.

The helmet sticker shall be placed on the left, backside of the helmet.

Pac-12 football mark requirements began in the 2010-11 academic year.

- * Pac-12 patch to be provided by the Conference office.
- * Pac-12 helmet decal to be provided by the Conference office.

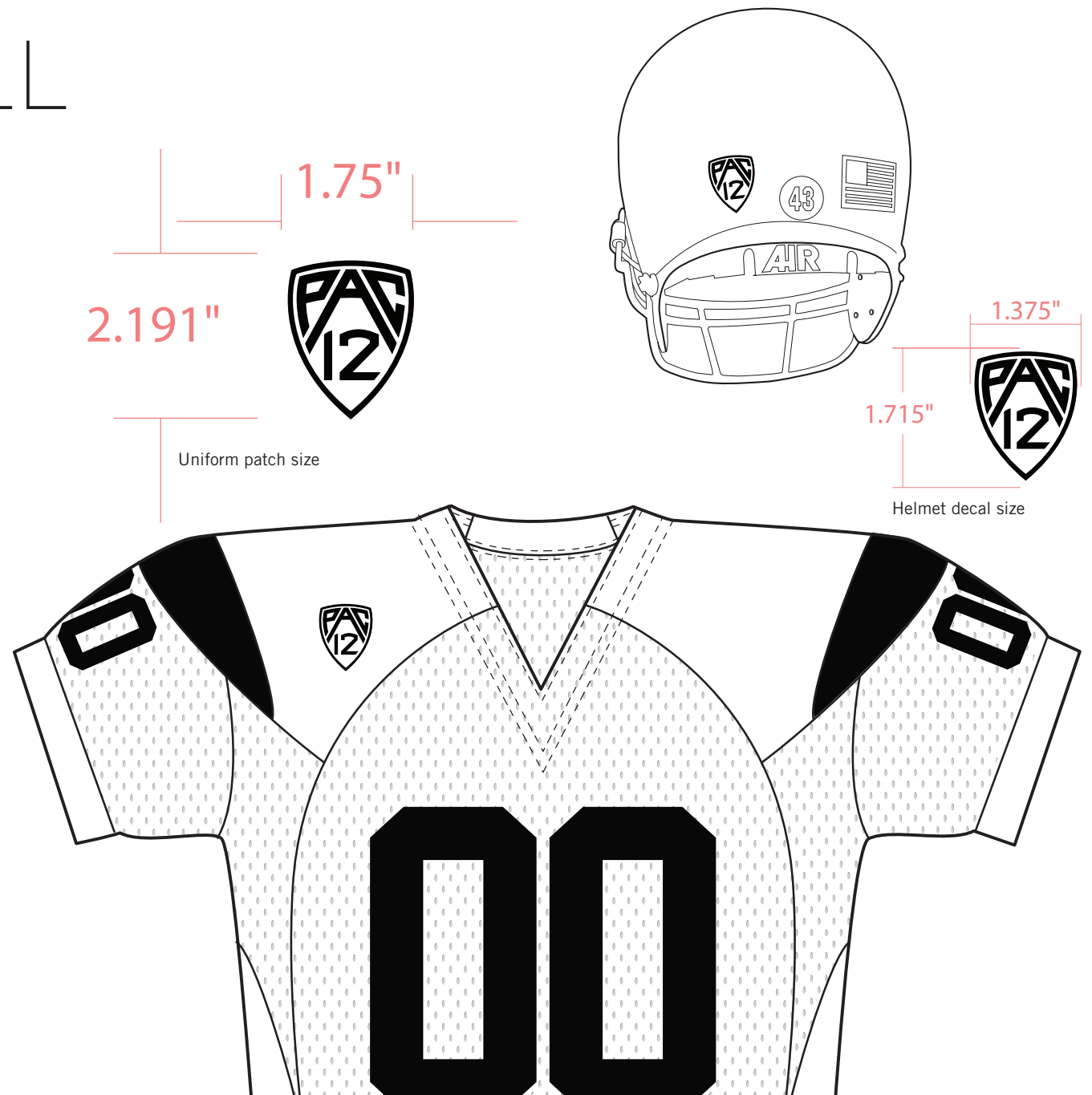

VOLLEYBALL

MARK USAGE

Per the included examples, the reduced mark (without the wave and mountain) shall be placed on the right sleeve, below the shoulder but above the elbow on the long sleeve uniform.

The reduced mark (without the wave and mountain) shall be placed mid-back, just below the number on the short sleeve or sleeveless uniform.

Pac-12 volleyball mark requirements began in the 2010-11 academic year.

*Pac-12 mark to be screened on by the institution.



MEN'S BASKETBALL

MARK USAGE

Per the included examples, the reduced mark (without the wave and mountain) shall be placed on the left chest of the uniform.

Pac-12 basketball mark requirements began in the 2010-11 academic year.

* Pac-12 patch to be provided by the Conference office.

* Subject to change based on NCAA authenticating program.

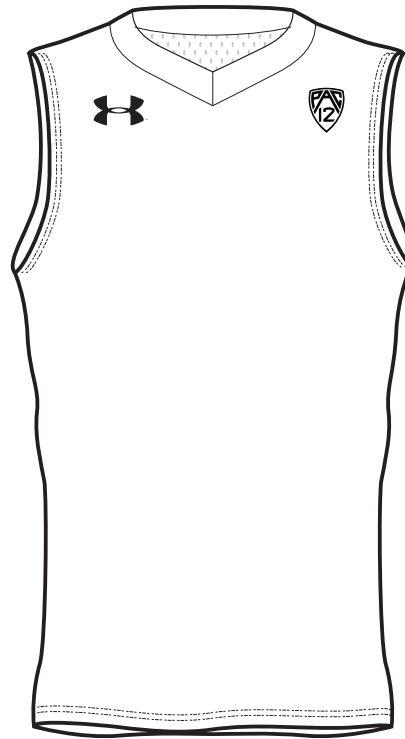
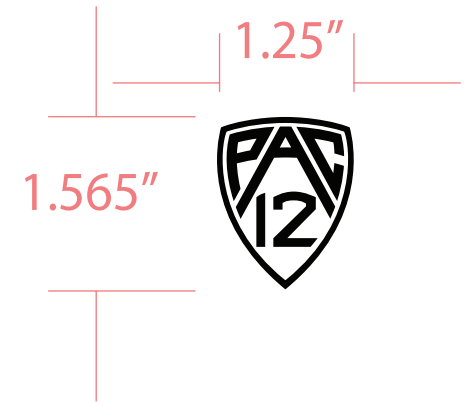

uniform type A.

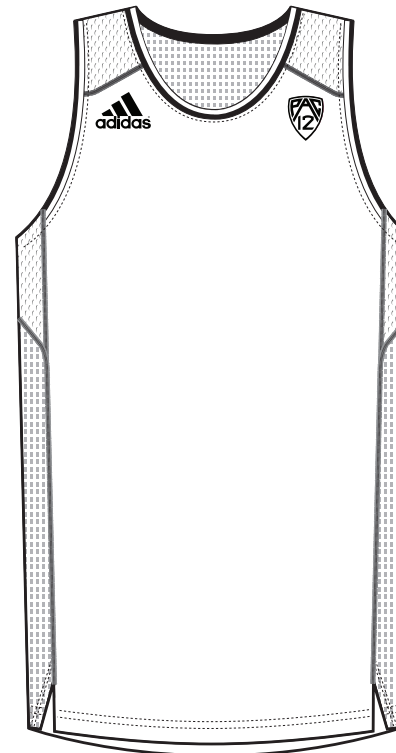

uniform type B.

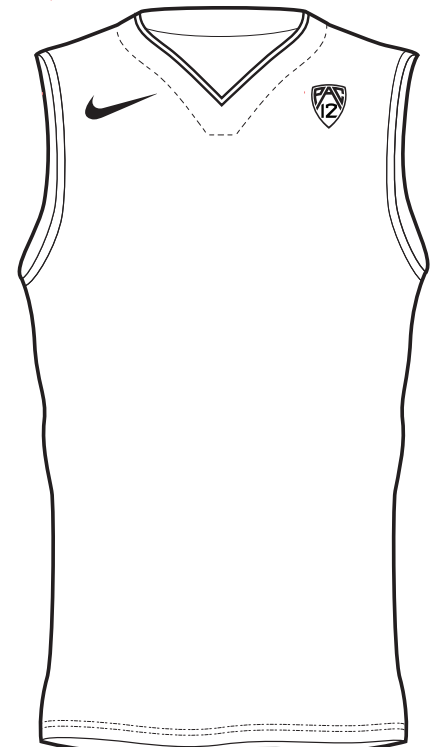

uniform type C.

WOMEN'S BASKETBALL

MARK USAGE

Per the included examples, the reduced mark (without the wave and mountain) shall be placed on the left chest of the uniform.

Pac-12 basketball mark requirements began in the 2010-11 academic year.

*Pac-12 patch to be provided by the Conference office.

*Subject to change based on NCAA authenticating program.

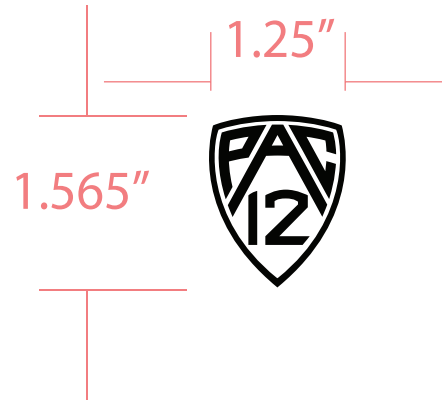

BASEBALL

MARK USAGE

Per the included examples, the reduced mark (without the wave and mountain) shall be placed on the left sleeve of the short sleeve uniform.

The reduced mark (without the wave and mountain) shall be placed on the right chest of the sleeveless uniform.

The helmet sticker shall be placed on the left, backside of the helmet.

Pac-12 baseball mark requirements began in the 2010-11 academic year.

* Pac-12 patch to be provided by the Conference office.

* Pac-12 helmet decal to be provided by the Conference office.

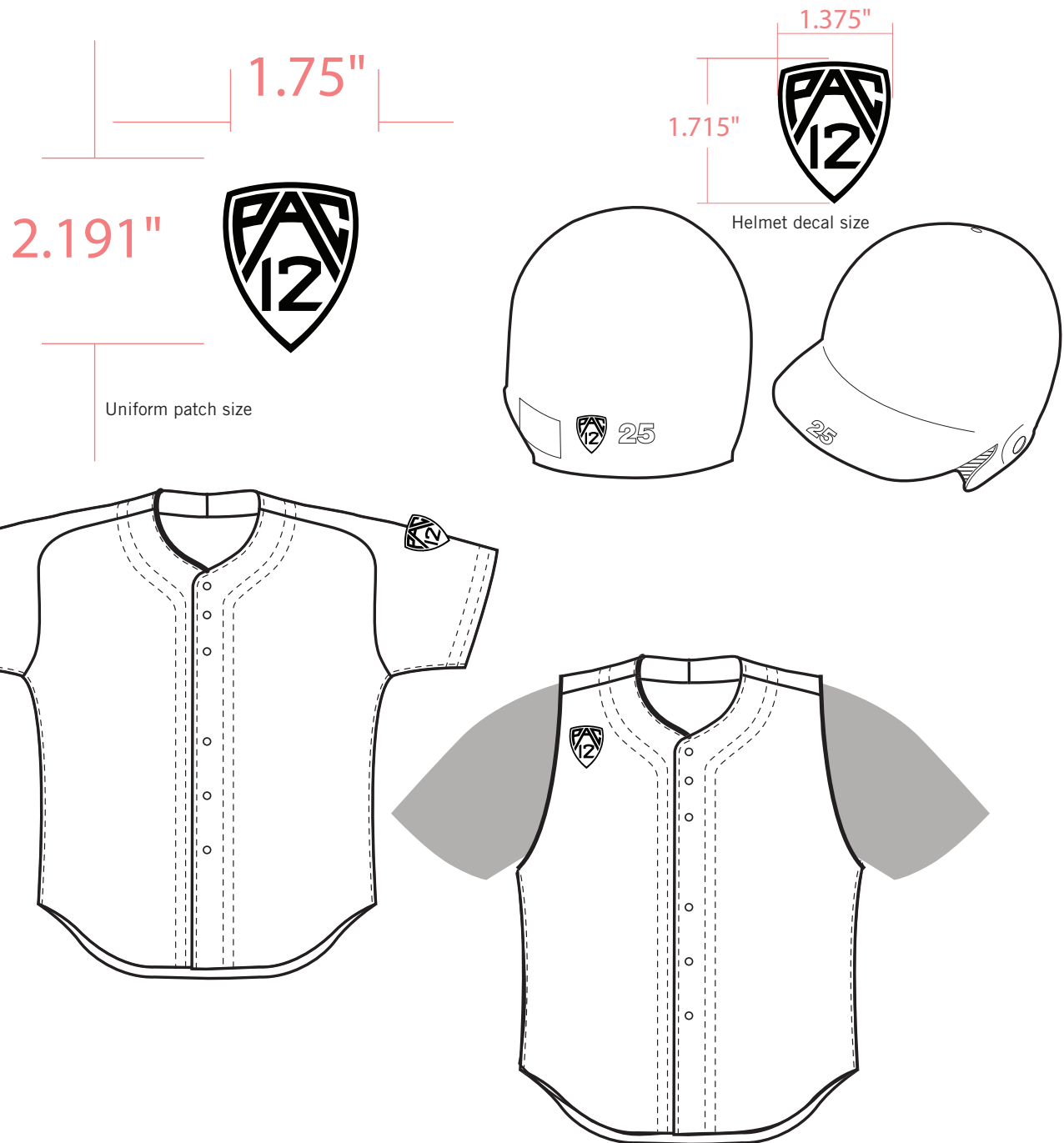

SOFTBALL

MARK USAGE

Per the included examples, the reduced mark (without the wave and mountain) shall be placed on the right chest of the uniform.

The helmet sticker shall be placed on the left, backside of the helmet.

Pac-12 softball mark requirements began in the 2010-11 academic year.

* Pac-12 patch to be provided by the Conference office.

* Pac-12 helmet decal to be provided by the Conference office.

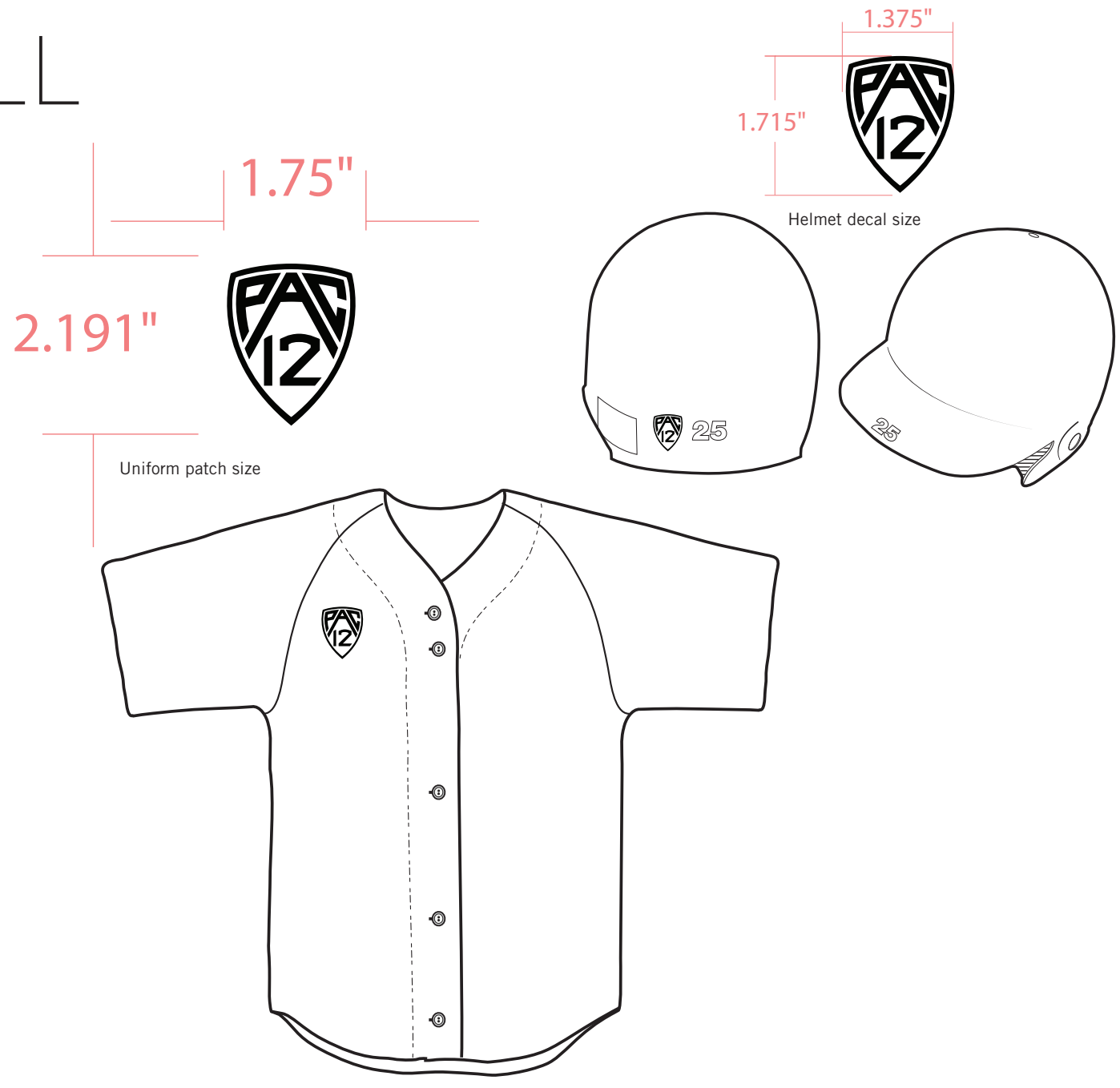

SOCCER

MARK USAGE

Per the included examples, the reduced mark (without the wave and mountain) shall be placed on the right sleeve of the uniform.

Pac-12 soccer mark requirements begin in the 2011-12 academic year.

*Pac-12 patch to be provided by the Conference office.

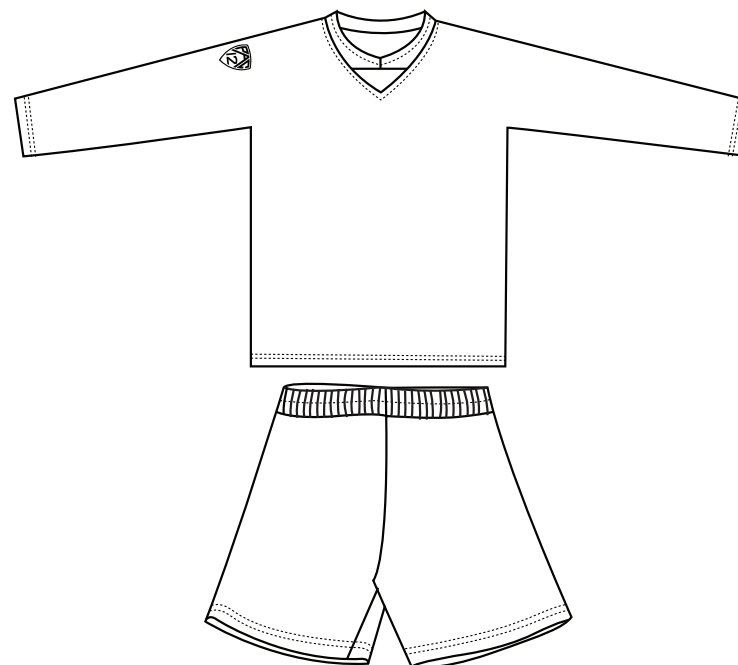
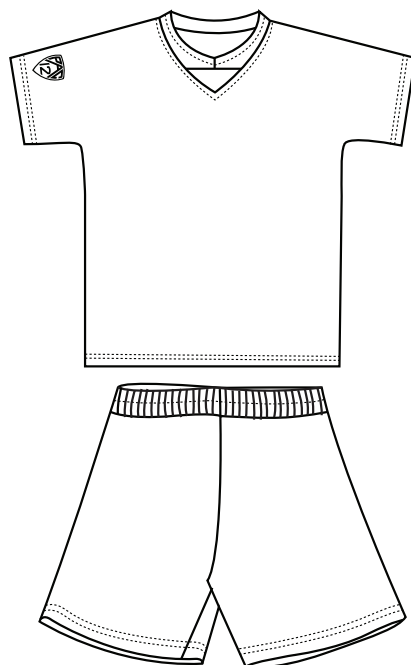

TENNIS

MARK USAGE

Per the included examples, the reduced mark (without the wave and mountain) shall be placed on the back of the neck of the uniform.

Pac-12 tennis mark requirements begin in the 2011-12 academic year.

* Pac-12 patch to be provided by the Conference office.

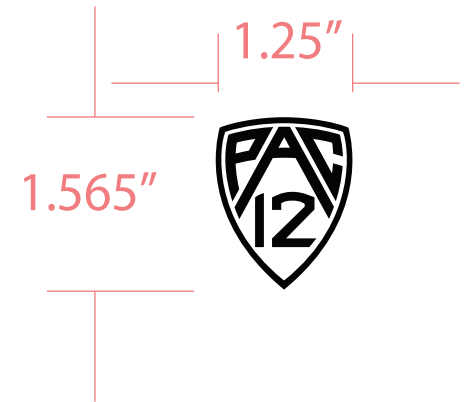

TRACK & FIELD

MARK USAGE

Per the included examples, the reduced mark (without the wave and mountain) shall be placed on the right chest of the sleeveless uniforms and right sleeve of the t-shirt style uniforms.

Pac-12 track & field mark requirements begin in the 2011-12 academic year.

*Pac-12 mark to be applied by the institution.

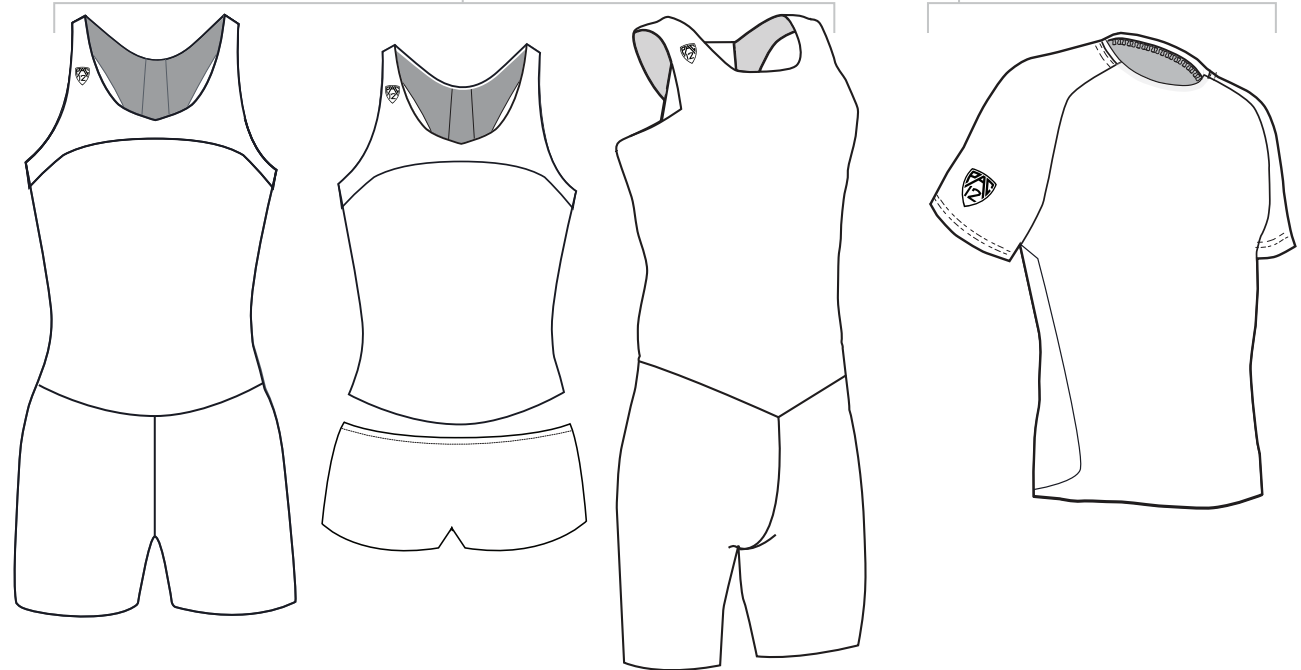

SWIMMING

MARK USAGE

Per the included example, the reduced mark (without the wave and mountain) shall be placed on the side of the swim cap.

Pac-12 swimming mark requirements begin in the 2011-12 academic year.

*Pac-12 mark to be applied by the institution.

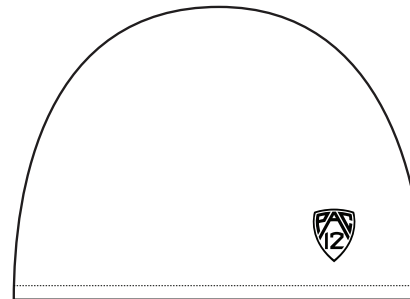
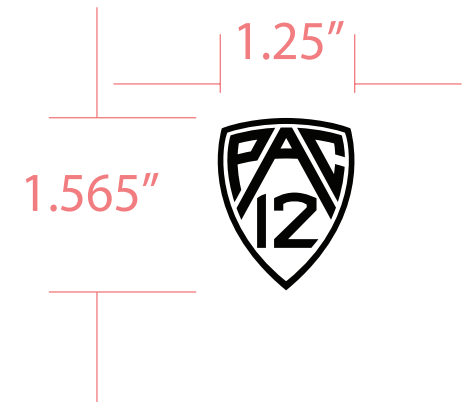

GOLF

MARK USAGE

Per the included examples, the reduced mark (without the wave and mountain) shall be placed on the right sleeve of the golf shirt.

The reduced mark (without the wave and mountain) may be placed on the side of the headwear opposite the manufacturer logo or on the side of the golf bag.

Please note - only the golf shirt is required to display Pac-12 mark. All other items are optional.

Pac-12 golf mark requirements begin in the 2012-13 academic year.

* Pac-12 patches to be provided by the Conference offices.

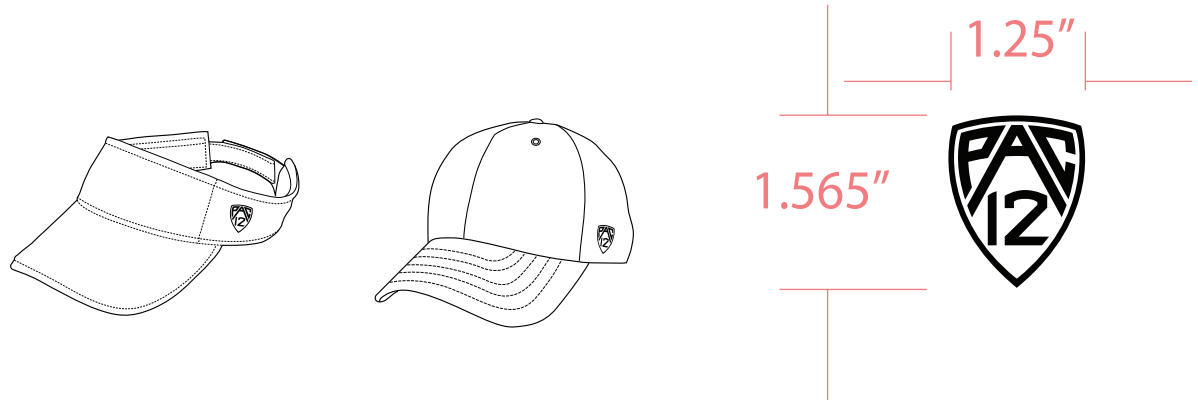
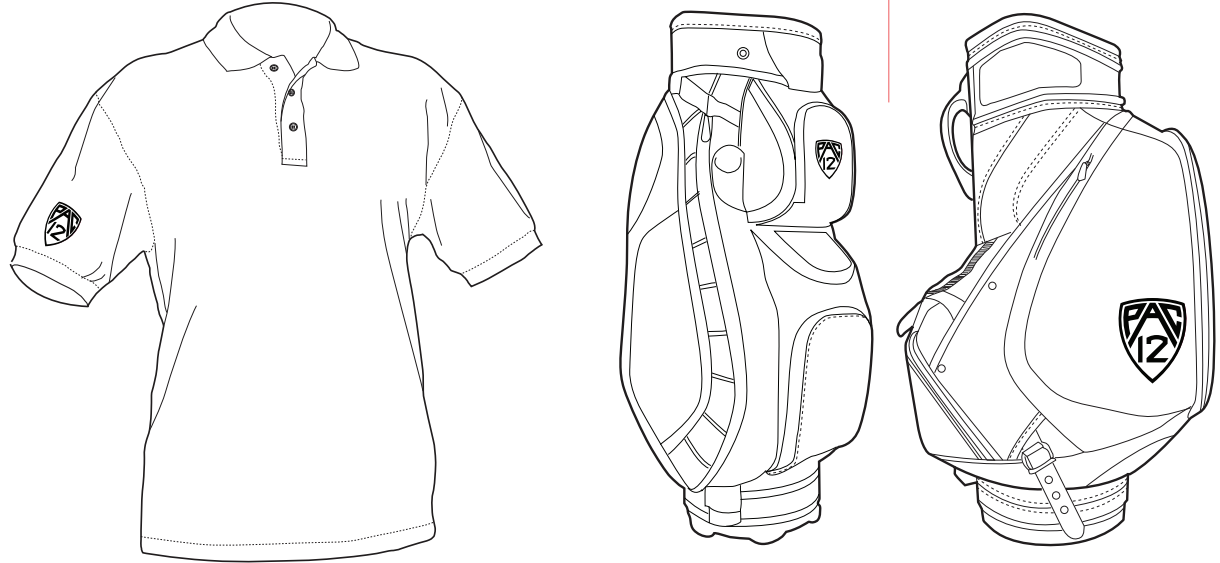

CROSS COUNTRY

MARK USAGE

Per the included examples, the reduced mark (without the wave and mountain) shall be placed on the right chest of the uniform.

Pac-12 cross country mark requirements begin in the 2012-13 academic year.

*Pac-12 mark to be applied by the institution.

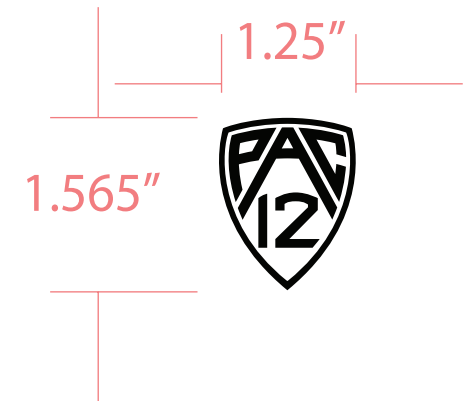
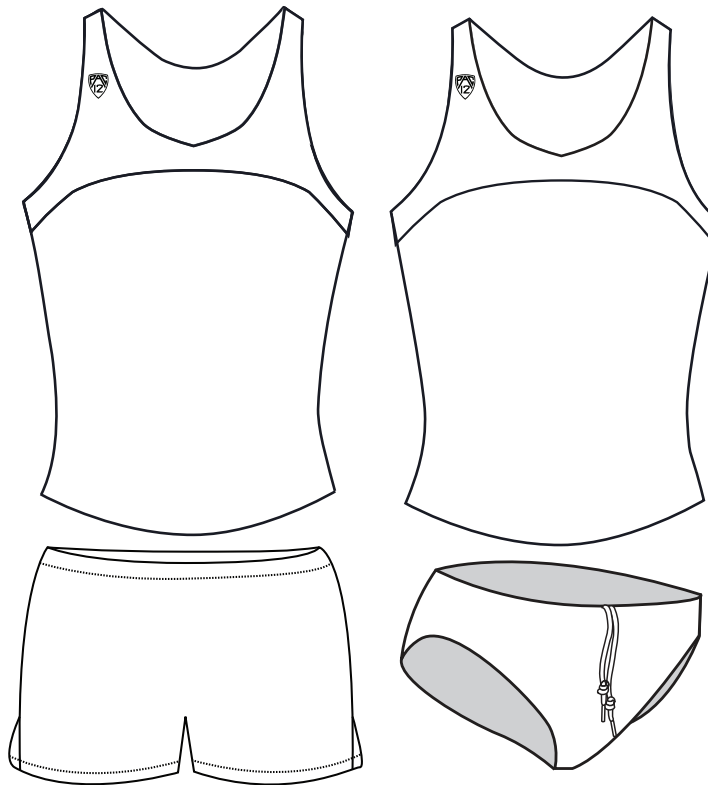

GYMNASTICS

MARK USAGE

Per the included examples, the reduced mark (without the wave and mountain) shall be placed on the left hip of the uniform.

Pac-12 gymnastics mark requirements begin in the 2012-13 academic year.

*Pac-12 mark to be applied by the institution.

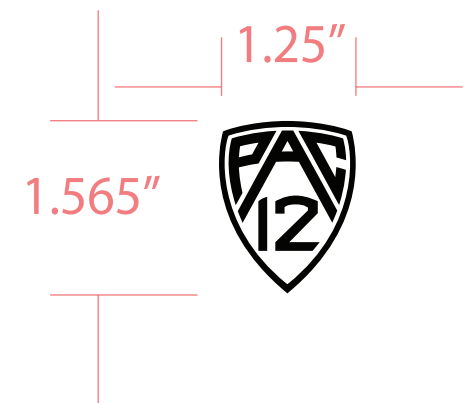
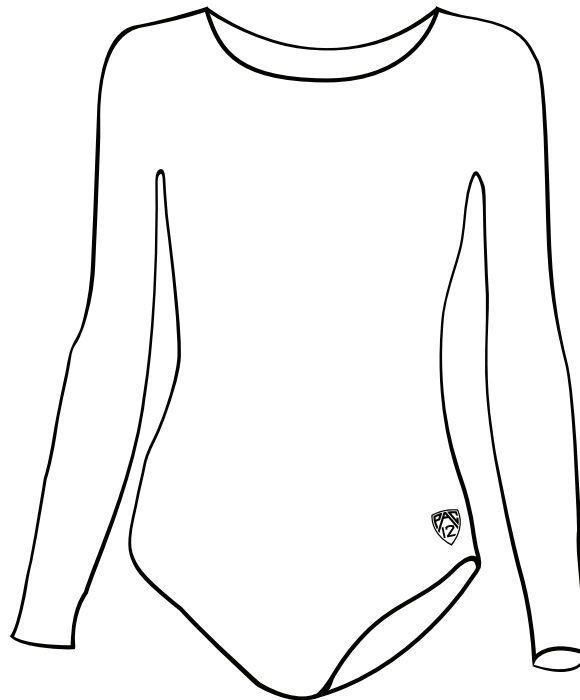

ROWING

MARK USAGE

Per the included examples, the reduced mark (without the wave and mountain) shall be placed on the center back of the singlet and jersey.

Pac-12 rowing mark requirements begin in the 2012-13 academic year.

*Pac-12 mark to be applied by the institution.

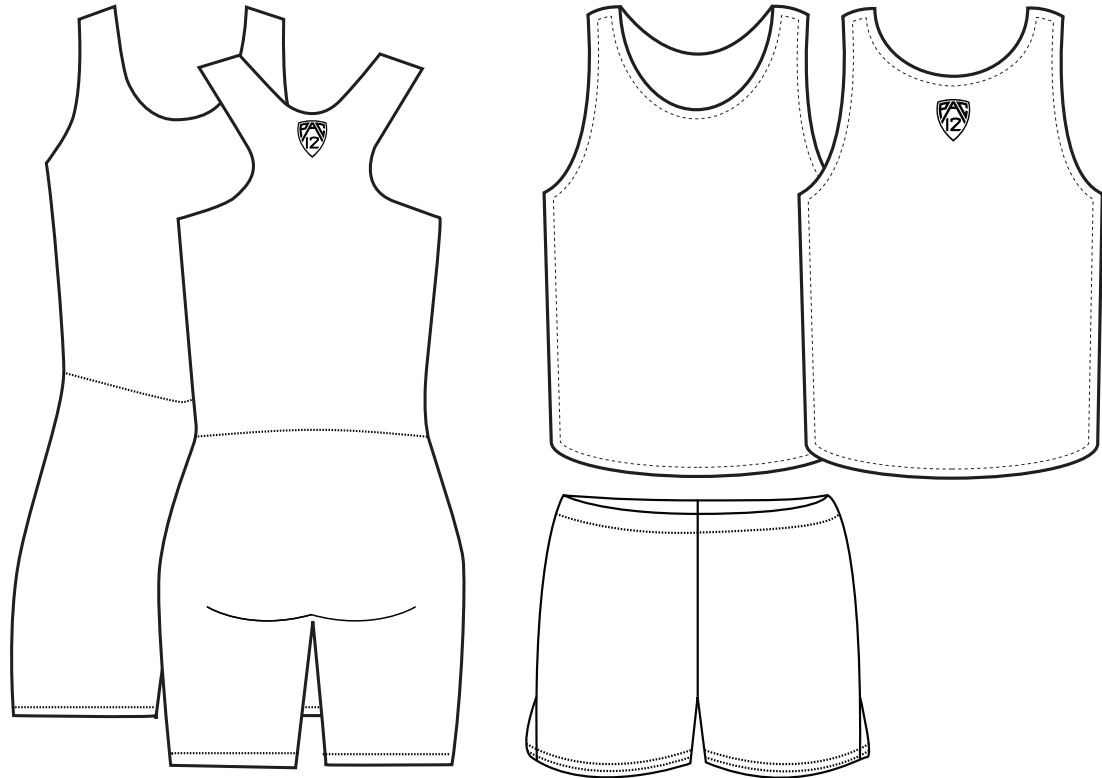
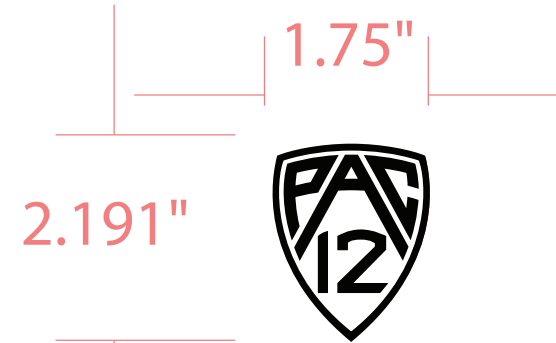

WRESTLING

MARK USAGE

Per the included examples, the reduced mark (without the wave and mountain) shall be placed on the upper center back of the singlet.

Pac-12 wrestling mark requirements begin in the 2012-13 academic year.

*Pac-12 mark to be applied by the institution.

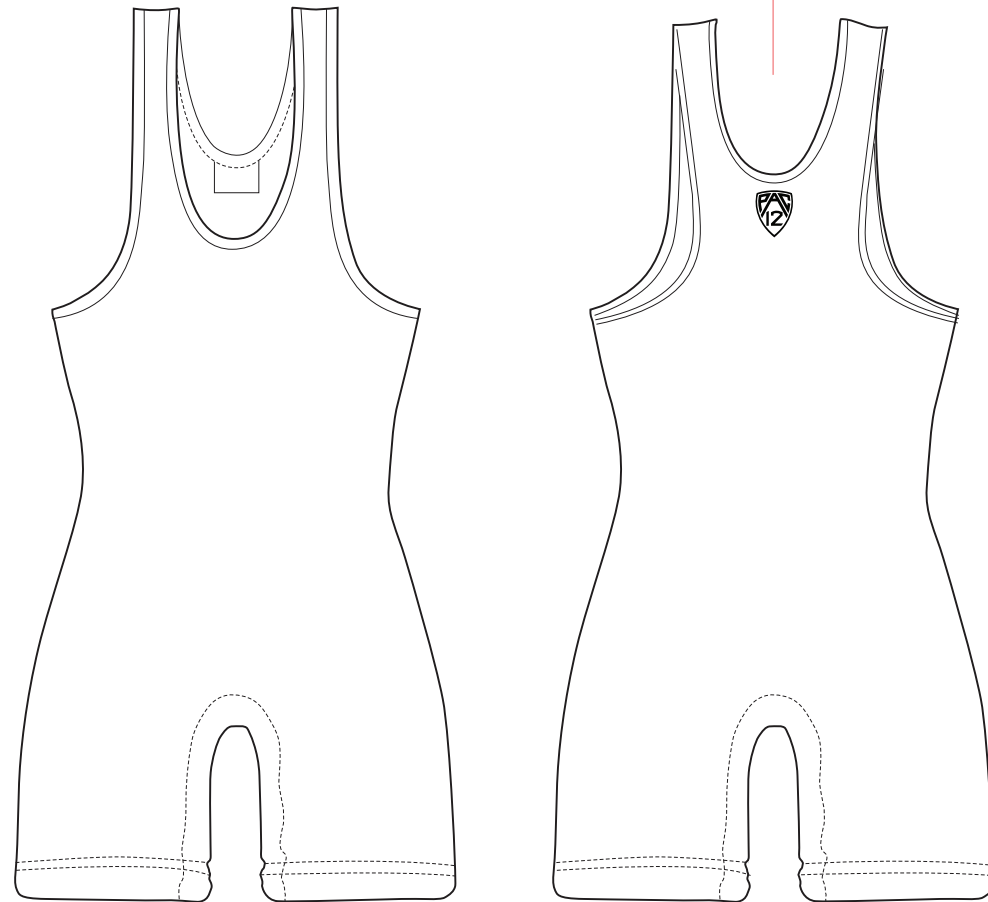

WARM-UPS

OPTIONAL MARK USAGE

Per the included examples, the reduced mark (without the wave and mountain) shall be placed on either the right or left sleeve or right chest of the warm-up jacket.

* Institutions wishing to apply the mark to warm-ups must contact the Conference office for patches.

* Institutions may screen the mark on their warm-ups.

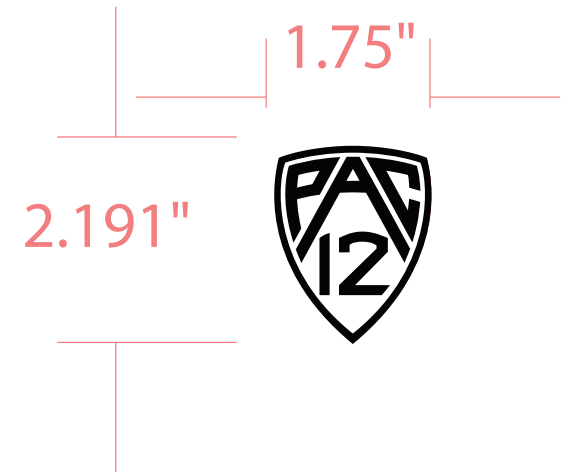

BAGS & BACKPACKS

OPTIONAL MARK USAGE

Per the included examples, the reduced mark (without the wave and mountain) shall be placed on the side or front of bags and backpacks.

* Institutions wishing to apply the mark to bags and backpacks must contact the Conference office for patches.

* Institutions may screen the mark on their bags and backpacks.

1.75"

2.191"

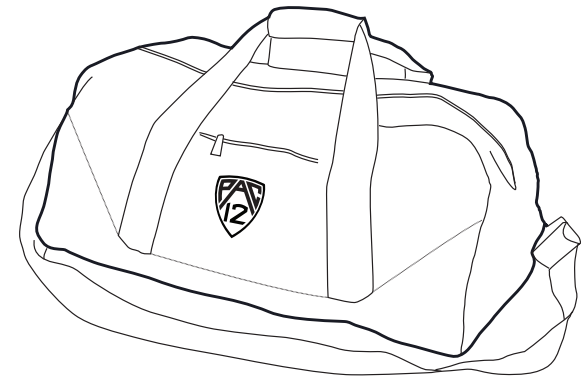
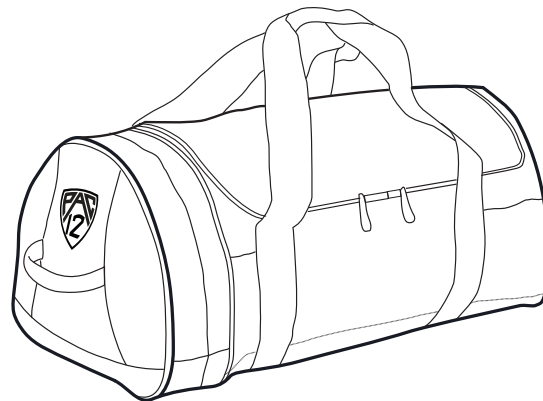
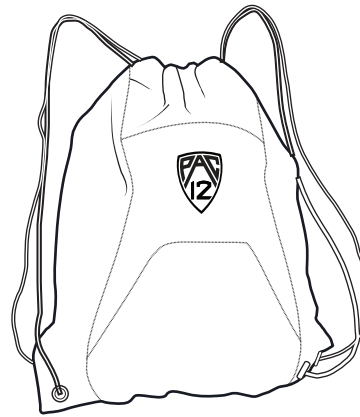



VISUAL IDENTITY STANDARDS // FACILITIES // WSU

REQUIRED MARK USAGE

FACILITIES REQUIREMENT ROLL-OUT

Facilities logo requirements will be rolled-out according to the schedule shown here.

SPORT	2010-11	2011-12	2012-13
Football	Required	Required	Required
Men's Basketball	Required	Required	Required
Women's Basketball	Required	Required	Required
Women's Volleyball	Optional	Required	Required
Baseball	Optional	Required	Required
Softball	Optional	Required	Required
Men's Soccer	Optional	Required	Required
Women's Soccer	Optional	Required	Required
Men's Tennis	Optional	Required	Required
Women's Tennis	Optional	Required	Required
Track & Field	Optional	Required	Required
Swimming & Diving	Optional	Required	Required
Men's Golf	Optional	Optional	Required
Women's Golf	Optional	Optional	Required
Men's Cross Country	Optional	Optional	Required
Women's Cross Country	Optional	Optional	Required
Gymnastics	Optional	Optional	Required
Rowing	Optional	Optional	Required
Wrestling	Optional	Optional	Required



- PMS 201 c
- PMS 431 c
- WHITE

WASHINGTON STATE UNIVERSITY

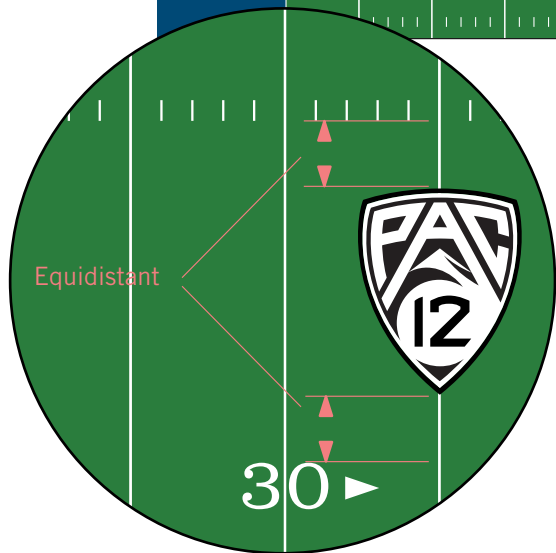
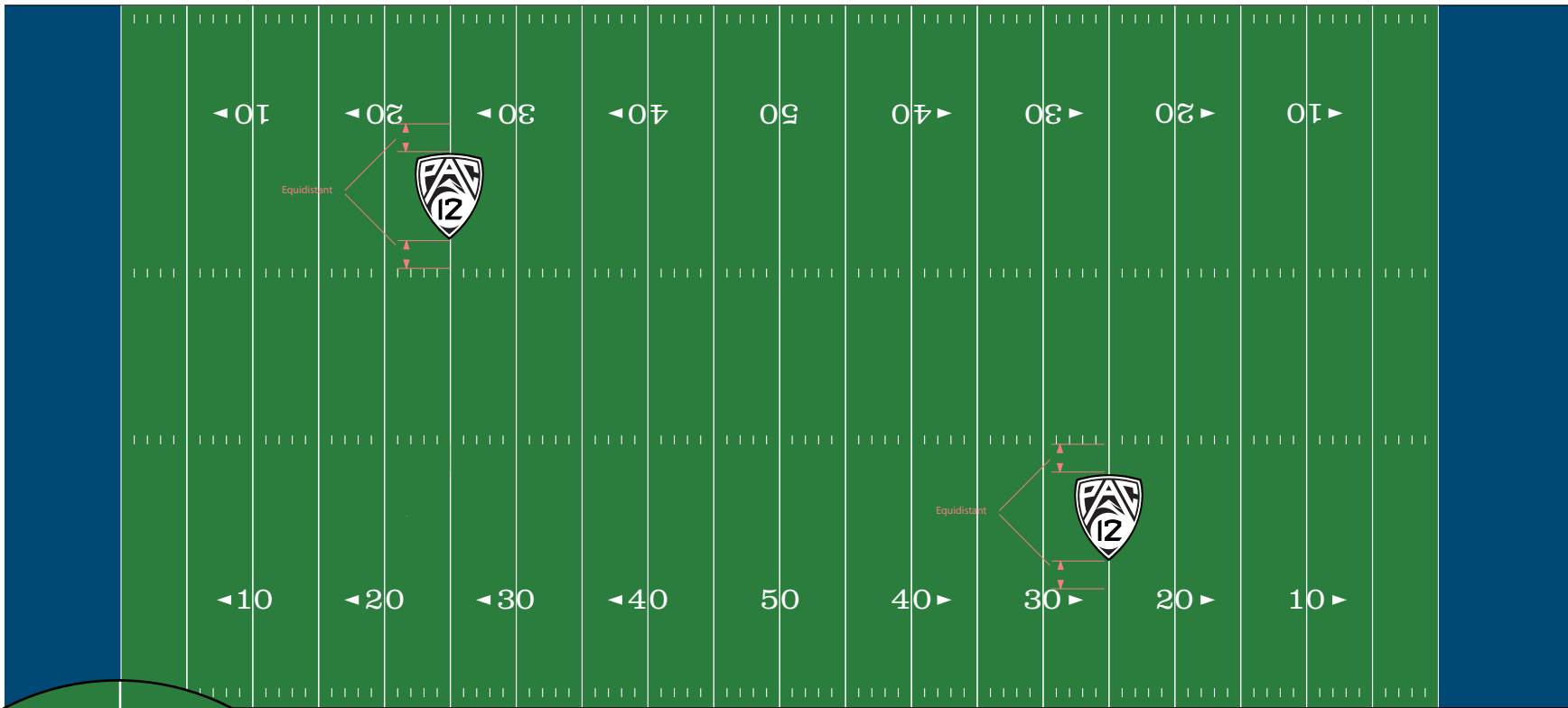

placement detail

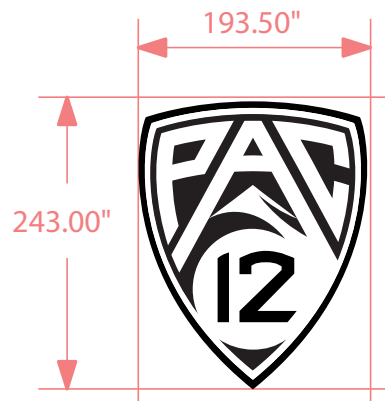

shield dimensions

Football Field – The use of the Pac-12 mark was required on all football fields beginning in the 2010-2011 academic year.

It is essential that each institution incorporate the Pac-12 Conference mark within the designated area on the 25-yard line. The mark must appear in institutional colors on the playing surface. When viewed from the 50-yard line camera position, the mark shall appear below the near hash mark on the right side of the field and above the far hash mark on the left side of the field. Both marks must be oriented towards the television cameras.

Per the diagrams on this page, the shield shall be centered on the 25-yard line and positioned equidistant from the respective hash mark and number. The 25-yard line must remain visible for official use. The required subtle shadow line shall not be visible on television.

Additional mark usage within the football facility is encouraged but not required. Utilization of the primary mark (blue gradient) is recommended in such instances.

*Pac-12 stencil to be provided by the Conference office.

*Institutions are responsible for mark application.

*Marks applied to the field with paint shall be applied with two coats prior to every game.

*The Pac-12 strongly recommends painting the marks in the summer months to allow the marks to “set” into the field, enhancing their visual appeal throughout the season.

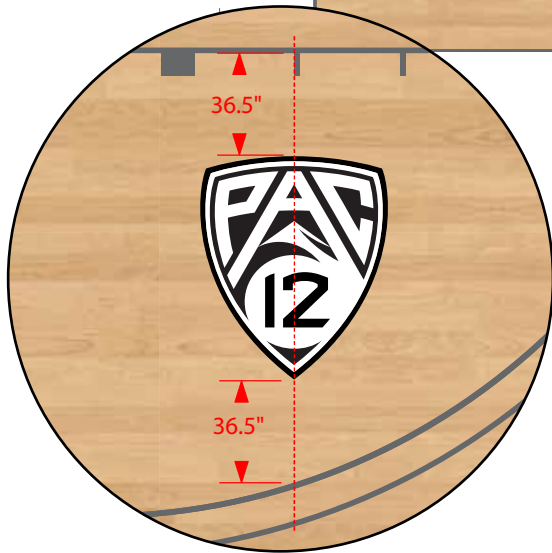
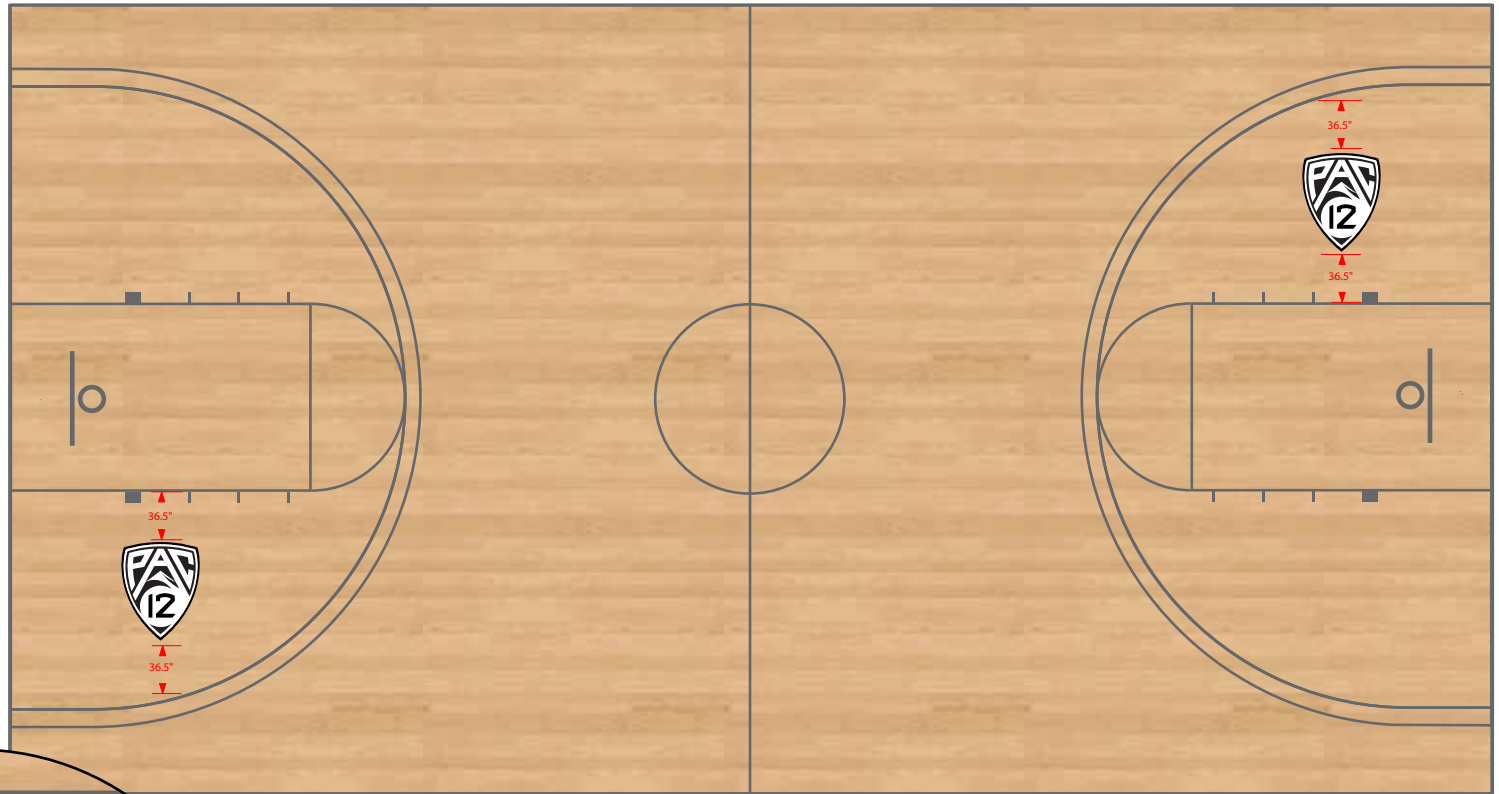

placement detail

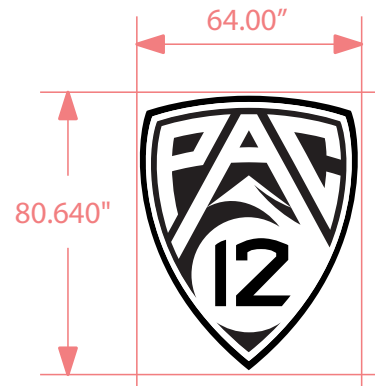

shield dimensions

Basketball Court – The use of the Pac-12 Conference mark was required on all basketball courts beginning in the 2010-2011 academic year.

It is essential that each institution incorporate the Pac-12 Conference mark within the designated area between the key and the 3-point line on both sides of the court. The marks must be painted in institutional colors on the playing surface and decals may not be used. When viewed from the center court camera position, the mark shall appear below the key on the left side of the court and above the key on the right side of the court. Both marks must be oriented towards the television cameras.

Per the diagrams on this page, the shield shall be centered on the baseline edge of the second lane-space mark and positioned 36.5" from the key. Additional mark usage within the basketball facility is encouraged but not required. Utilization of the primary mark (blue gradient) is recommended in such instances.

*Digital logo file to be provided by the Conference office.

*Institutions responsible for mark application.

BASEBALL FIELD

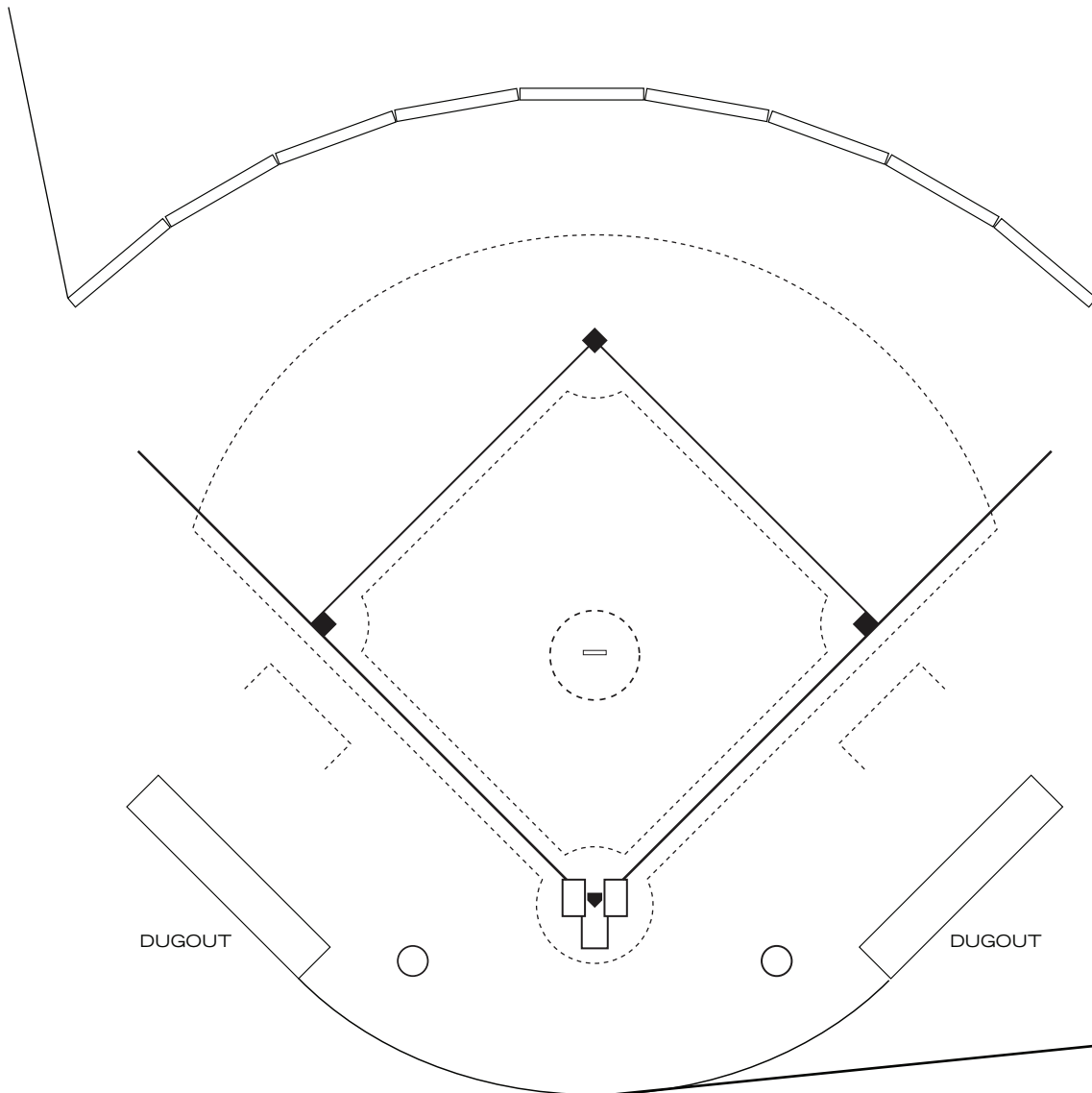

Baseball Field – The use of the Pac-12 Conference mark is required on all baseball fields beginning in the 2011-2012 academic year.

Per the diagrams on this page, the marks must appear in institutional colors on the backstop wall.

Additional usage within the baseball facility is encouraged but not required. Utilization of the primary mark (blue gradient) is recommended in such instances.

*Decals for backstop to be provided by the Conference office.

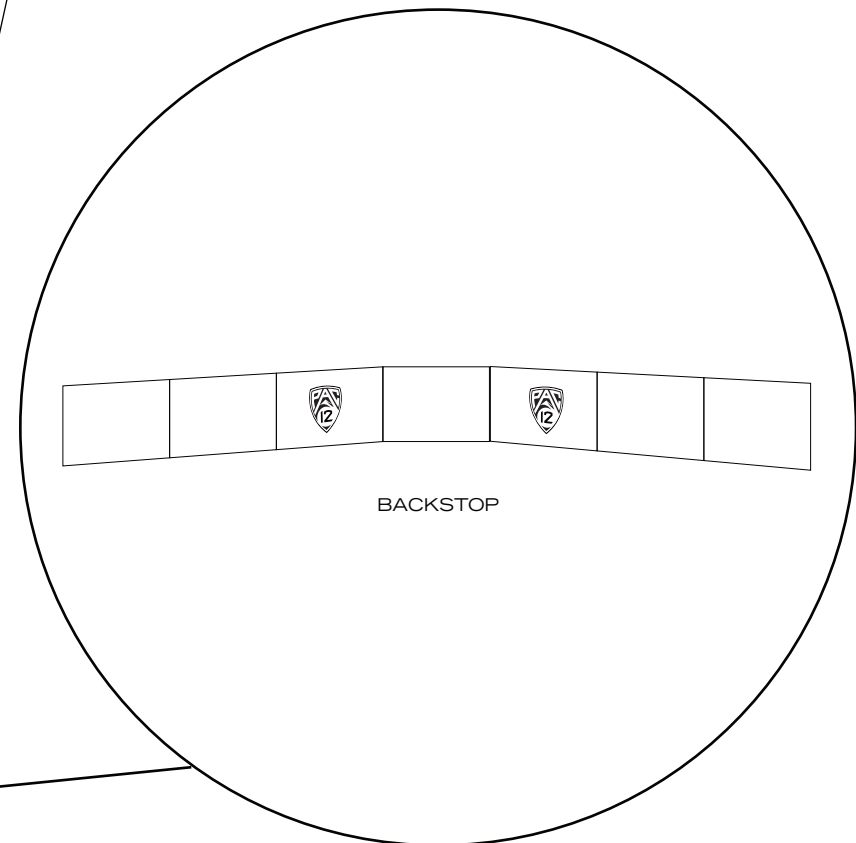

SOFTBALL FIELD

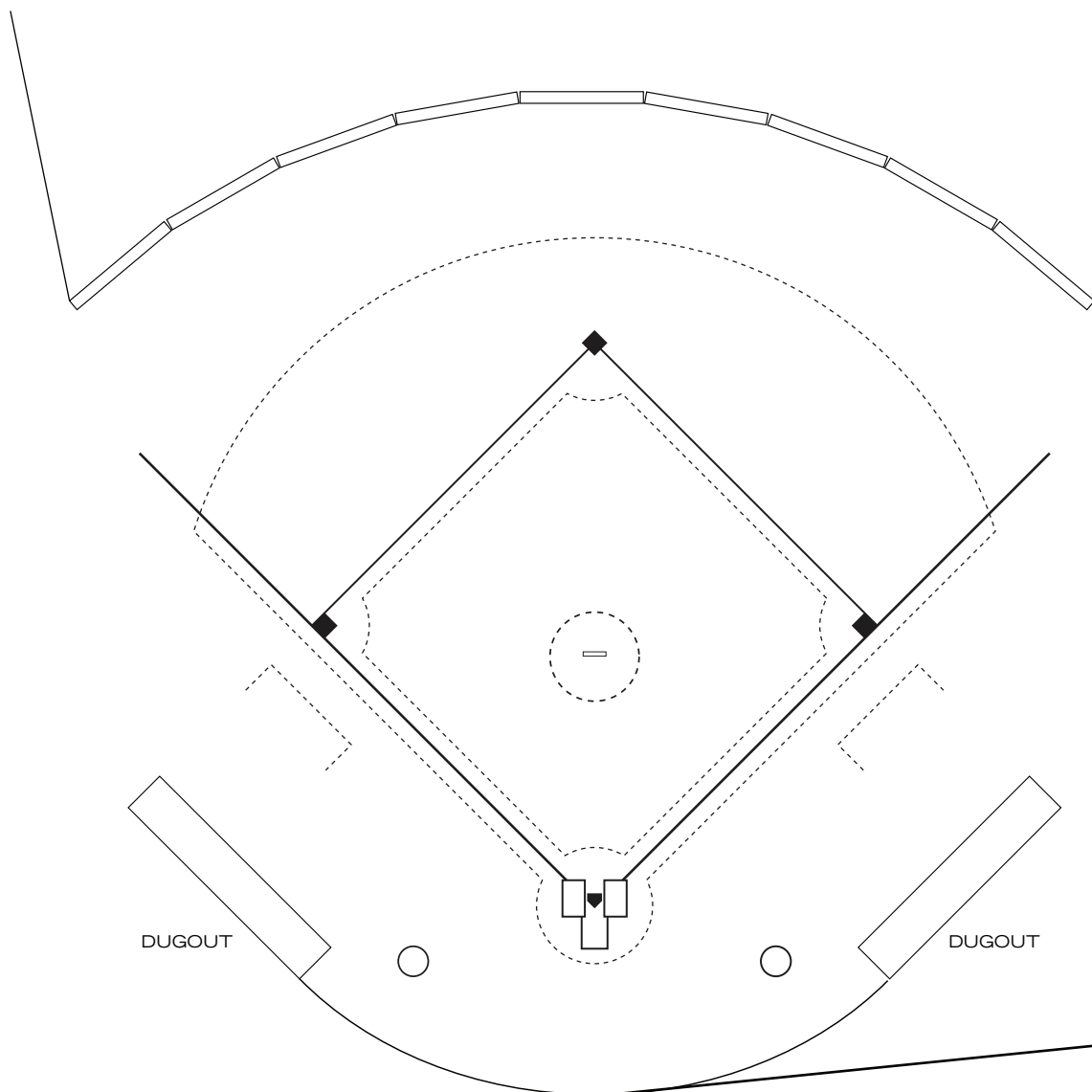

Softball Field – The use of the Pac-12 Conference mark is required on all softball fields beginning in the 2011-2012 academic year.

Per the diagrams on this page, the marks must appear in institutional colors on the backstop wall.

Additional usage within the softball facility is encouraged but not required. Utilization of the primary mark (blue gradient) is recommended in such instances.

*Decals for backstop to be provided by the Conference office.

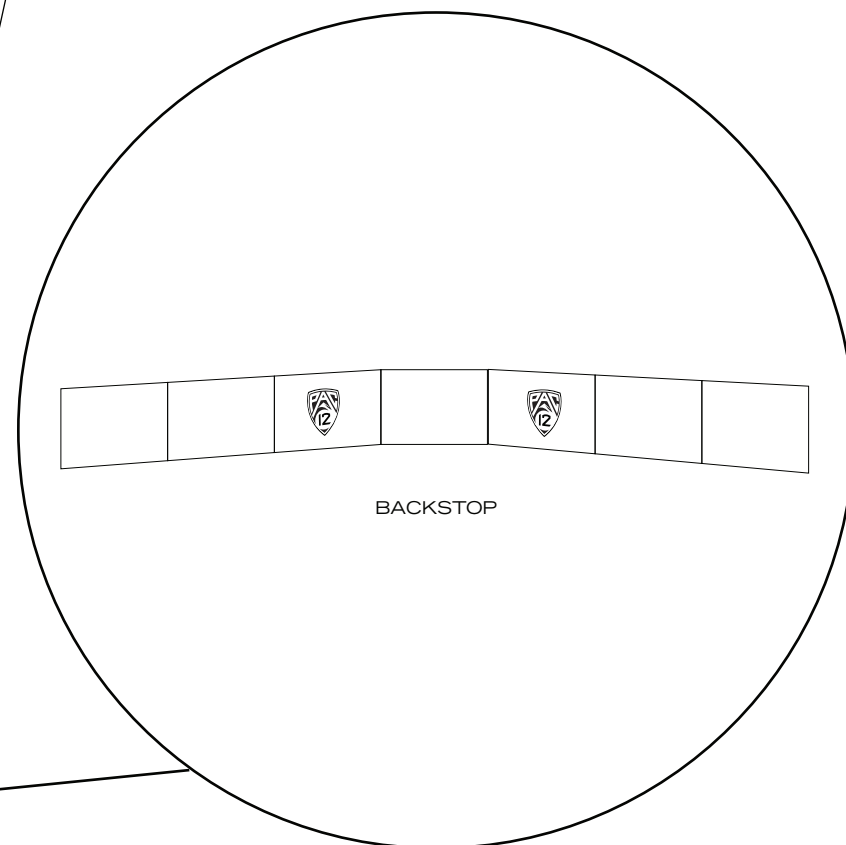

VOLLEYBALL COURT

Volleyball Court – The use of the Pac-12 Conference mark is required on all volleyball courts beginning in the 2011-2012 academic year.

Per the diagrams on this page, the marks must appear on the playing surface equidistant between the net and the end line in front of the benches and on both net pole pads. The marks must appear in institutional colors and be oriented towards the television cameras in both locations.

Additional usage within the volleyball facility is encouraged but not required. Utilization of the primary mark (blue gradient) is recommended in such instances.

*Decals for pole pads to be provided by the Conference office.

*Institutions responsible for mark application on the playing surface.

*In instances when the volleyball team plays on the basketball court, application of the marks on the playing surface is not required.

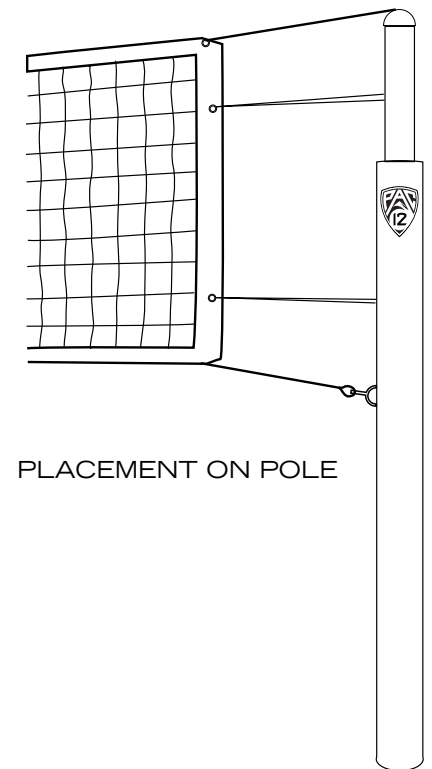
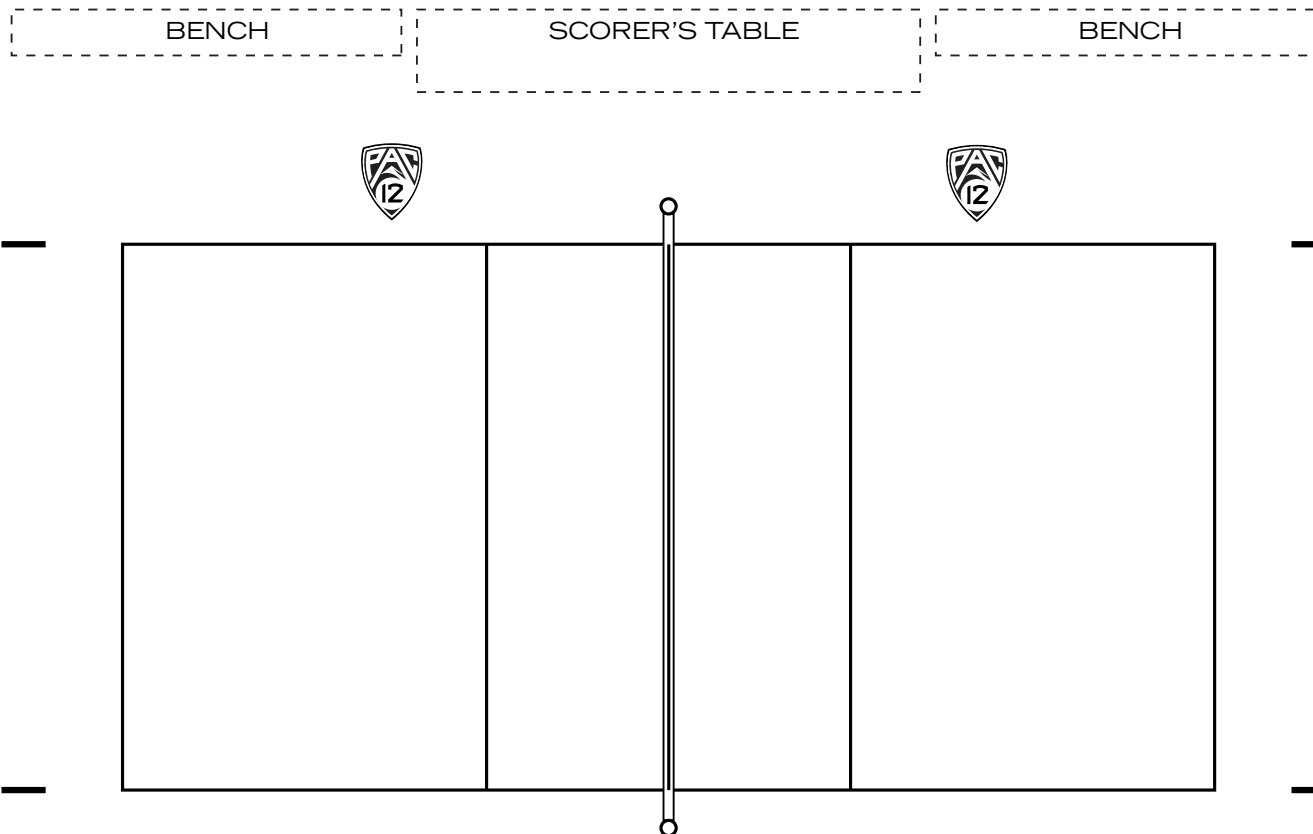

SOCCER FIELD

Soccer Field – The use of the Pac-12 Conference mark is required on all soccer fields beginning in the 2011-2012 academic year.

When viewed from the television camera position, the bottom of the mark on the left side of the field shall align with the top edge of the 18-yard box. The top of the mark on the right side of the field shall align with the bottom edge of the 18-yard box. Each mark shall be equidistant from the midfield line and the goal line. Both marks must be oriented towards the television cameras and appear in institutional colors.

Additional usage within the soccer facility is encouraged but not required. Utilization of the primary mark (blue gradient) is recommended in such instances.

*Institutions to use the Pac-12 football stencil provided by the Conference office for application.

*Marks applied to the field with paint shall be applied with two coats prior to every game.

*Institutions with turf fields may in-lay the marks.

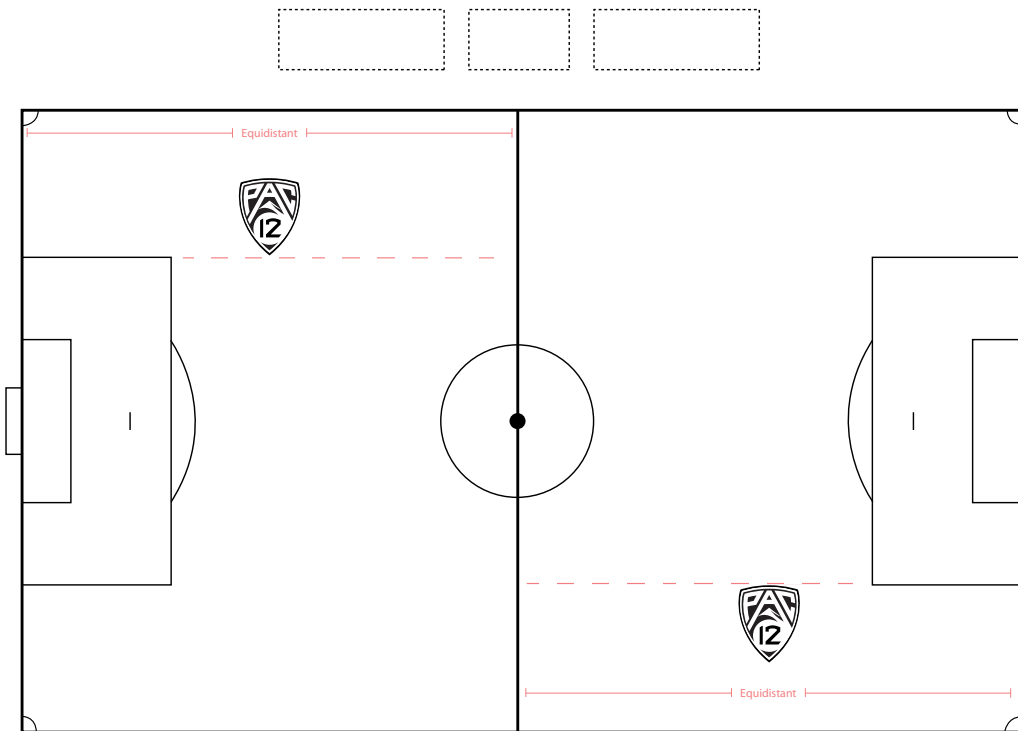

TENNIS COURT

Tennis Court – The use of the Pac-12 Conference mark is required on the net of all tennis courts beginning in the 2011-2012 academic year.

Per the diagram on this page, the mark shall appear on the net in the doubles alley on both sides of the court. The marks must appear in institutional colors.

Additional usage within the tennis facility is encouraged but not required. Utilization of the primary mark (blue gradient) is recommended in such instances.

*Net logo to be provided by the Conference office.

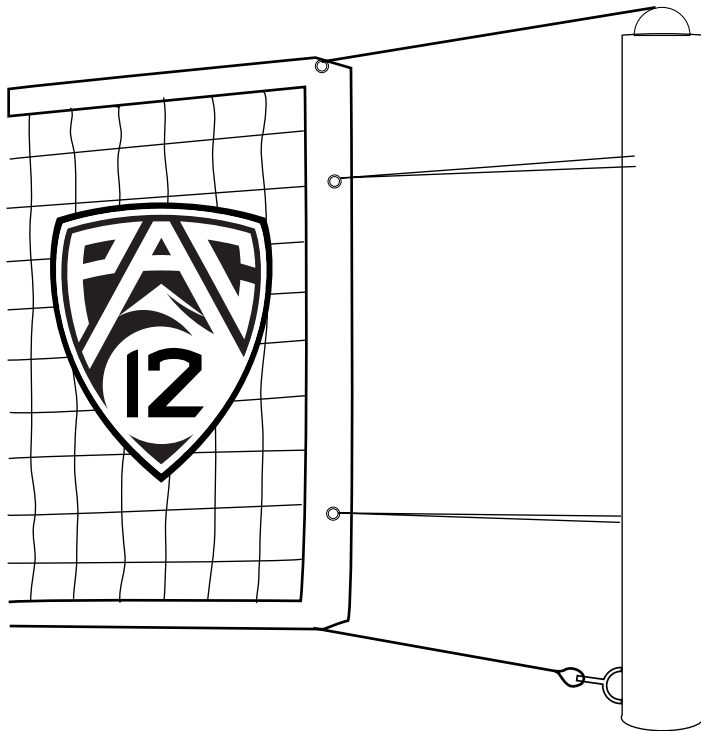

TRACK & FIELD VENUE

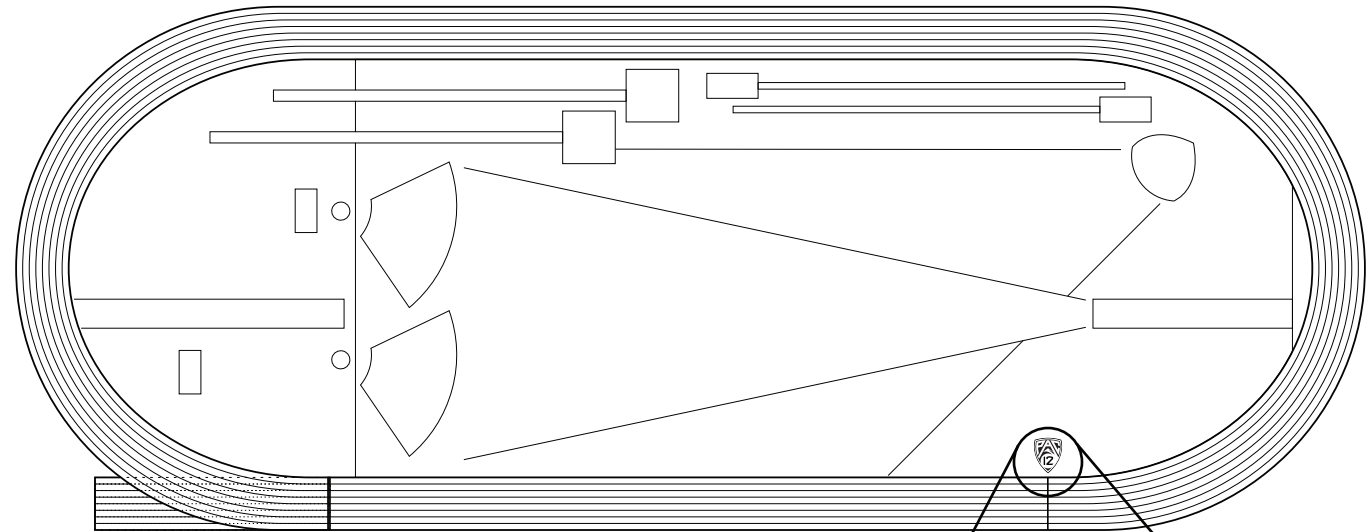

Track and Field Events – The use of the Pac-12 Conference mark is required on all tracks beginning in the 2011-2012 academic year.

Per the diagrams on this page, the mark shall appear on the inside of the track close to the finish line. The mark shall be oriented so that the bottom of the shield is closest to the track. If directly inside the finish line is not grass, the mark must be applied in another location within the infield. The marks must appear in institutional colors.

If there is no grass in the infield at all, please contact the Conference office for alternative mark placement.

Additional usage within the track facility is encouraged but not required. Utilization of the primary mark (blue gradient) is recommended in such instances.

*Institutions to use the Pac-12 football stencil provided by the Conference office for application.

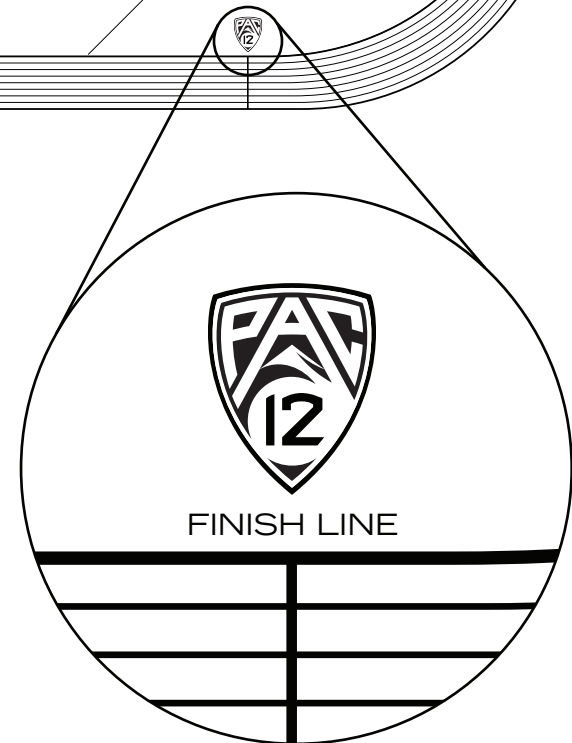

TRACK & FIELD VENUE

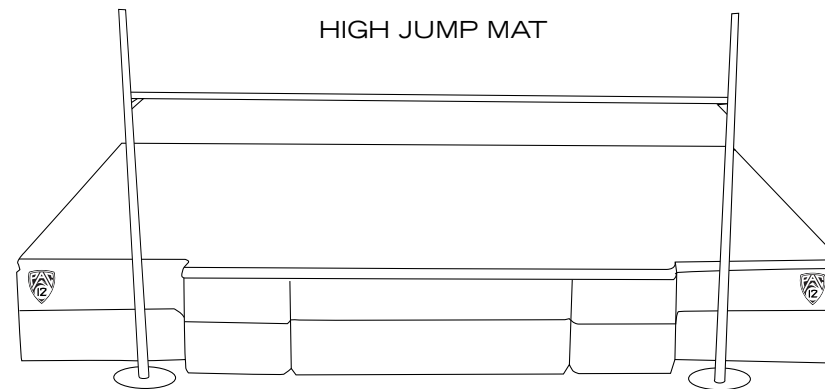
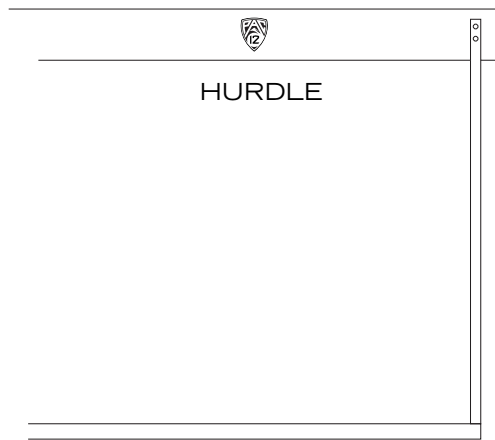

Track and Field Events – The use of the Pac-12 Conference mark is required on track and field equipment beginning in the 2011-2012 academic year.

Per the diagrams on this page, the mark shall appear on the hurdles and high jump mat in institutional colors. Location may be altered if institutional logo is already present in a designated location (e.g. if institutional mark is in the middle of the hurdle, Pac-12 mark can be placed on end).

Additional usage within the track facility is encouraged but not required. Utilization of the primary mark (blue gradient) is recommended in such instances.

*Decals for the hurdles and mat to be provided by the Conference office.

SWIMMING POOL

Swimming Pool – The use of the Pac-12 Conference mark is required in the swimming facilities beginning in the 2011-2012 academic year.

Per the diagram on this page, Pac-12 signage in institutional colors shall appear at mid-pool in the swimming facility. If the event is televised, the signage must be oriented towards the television cameras.

Additional usage within the swimming facility is encouraged but not required. Utilization of the primary mark (blue gradient) is recommended in such instances.

*Signage to be provided by the Conference office.

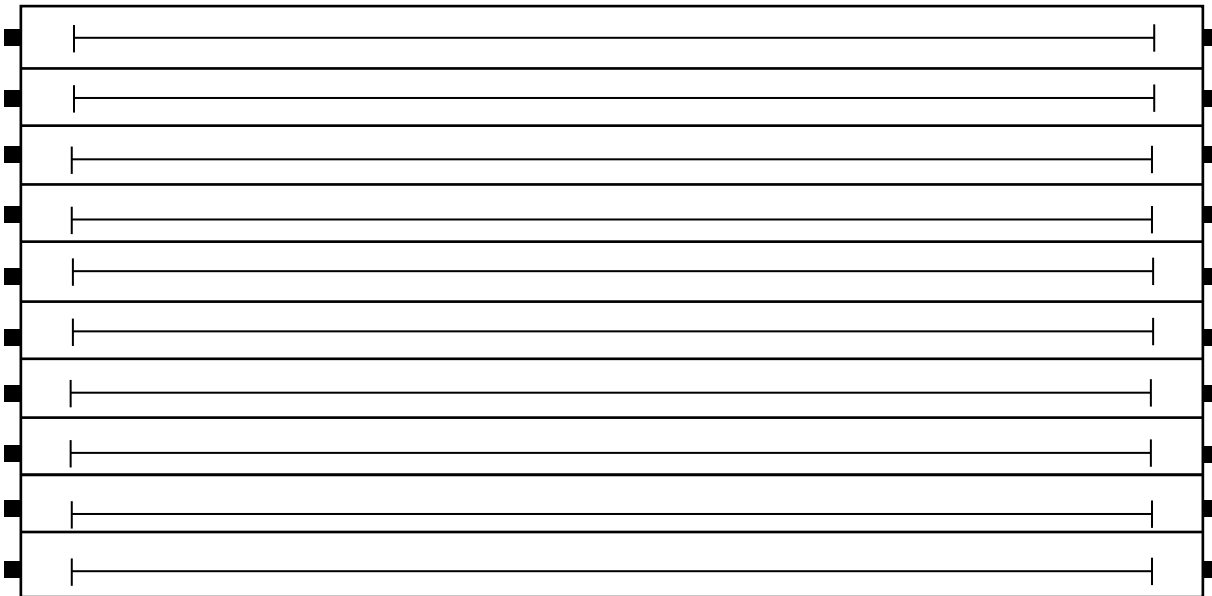

DIVING PLATFORM

Diving Platform – The use of the Pac-12 Conference mark is required on the diving platform beginning in the 2011-2012 academic year.

Per the diagram on this page, the mark shall appear on the side of the platform in institutional colors.

Additional usage within the diving facility is encouraged but not required. Utilization of the primary mark (blue gradient) is recommended in such instances.

*Decal for the platform to be provided by the Conference office.

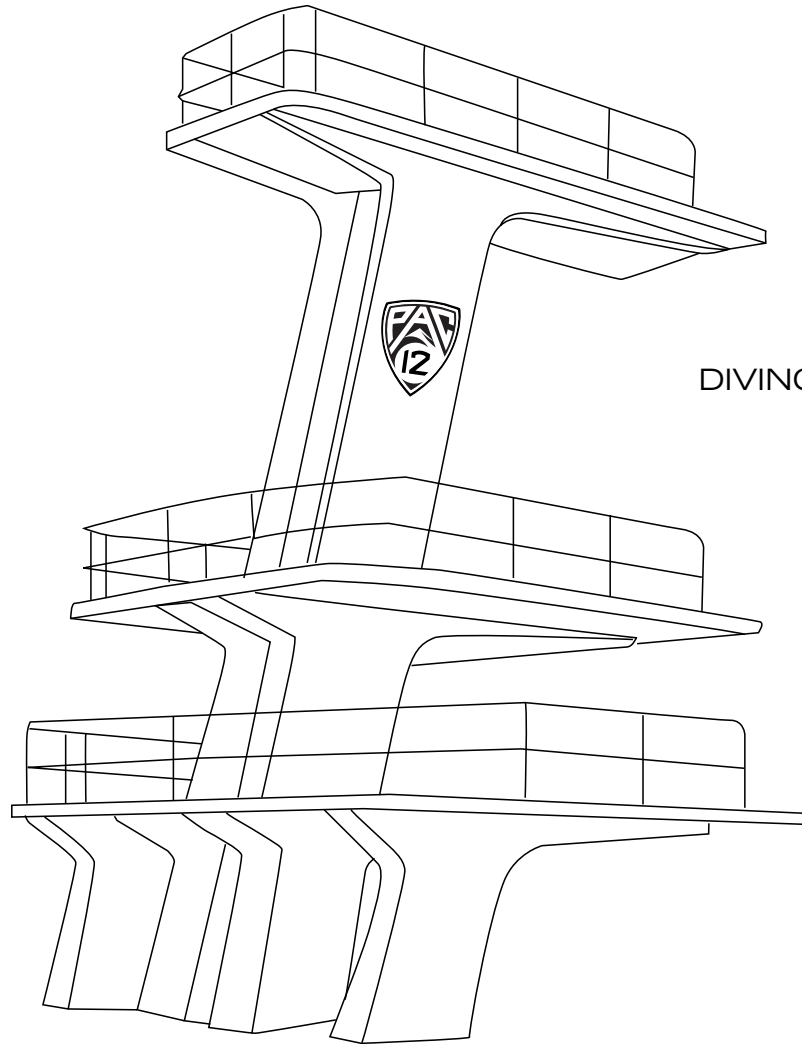

DIVING PLATFORM

GOLF

HOLE FLAG

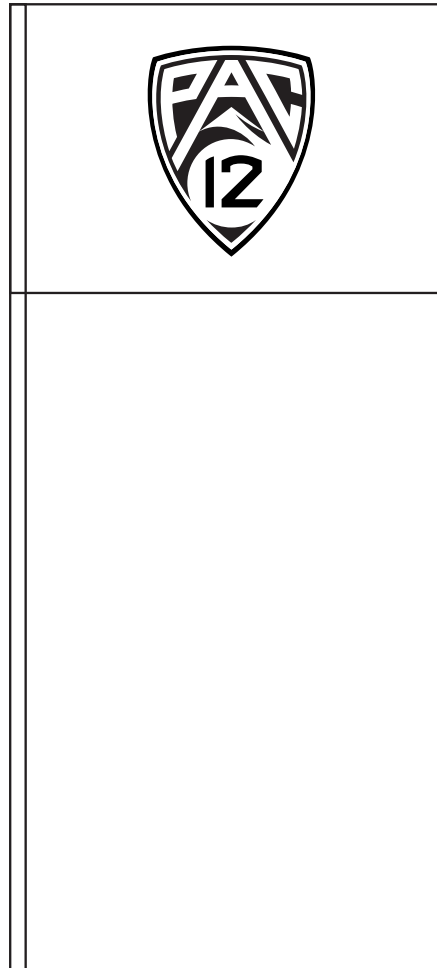

Hole Flags – The use of the Pac-12 Conference mark is required on golf hole flags on holes 3, 6, 9, 12, 15, and 18 beginning in the 2012-2013 academic year.

Per the diagram on this page, the mark shall appear in the center of the above listed 6 hole flags in institutional colors. Institutions are free to use hole flags of their choice for the remaining 12 holes.

Additional usage on the golf course and in surrounding facilities is encouraged but not required. Utilization of the primary mark (blue gradient) is recommended in such instances.

*6 hole flags to be provided by the Conference office.

GYMNASTICS

Gymnastics Apparatuses – The use of the Pac-12 Conference mark is required in the gymnastics facility beginning in the 2012-2013 academic year.

Per the diagrams on this page, the mark shall appear on the floor routine carpet in at least one location in institutional colors. Additionally, the mark shall appear on the table skirt of the head judge's table for each event in institutional colors. If the event is televised, the mark on the carpet and the head judge's table should be oriented towards the television cameras.

Additional usage within the gymnastics facility is encouraged but not required. Utilization of the primary mark (blue gradient) is recommended in such instances.

*Decal for the carpet to be provided by the Conference office.

*Table skirt to be provided by the Conference office.



TABLE SKIRT

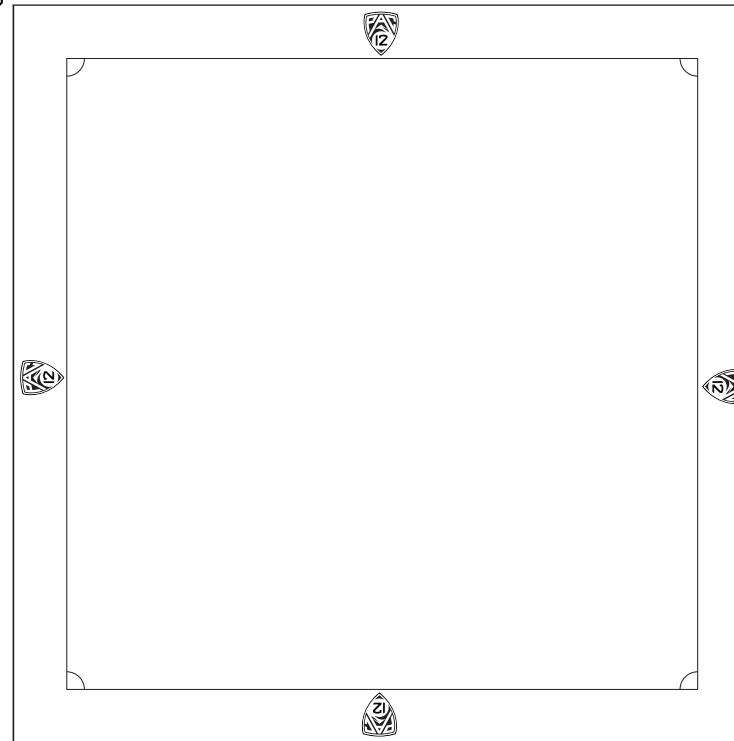

FLOOR ROUTINE AREA

WRESTLING MAT

JUDGE'S TABLE

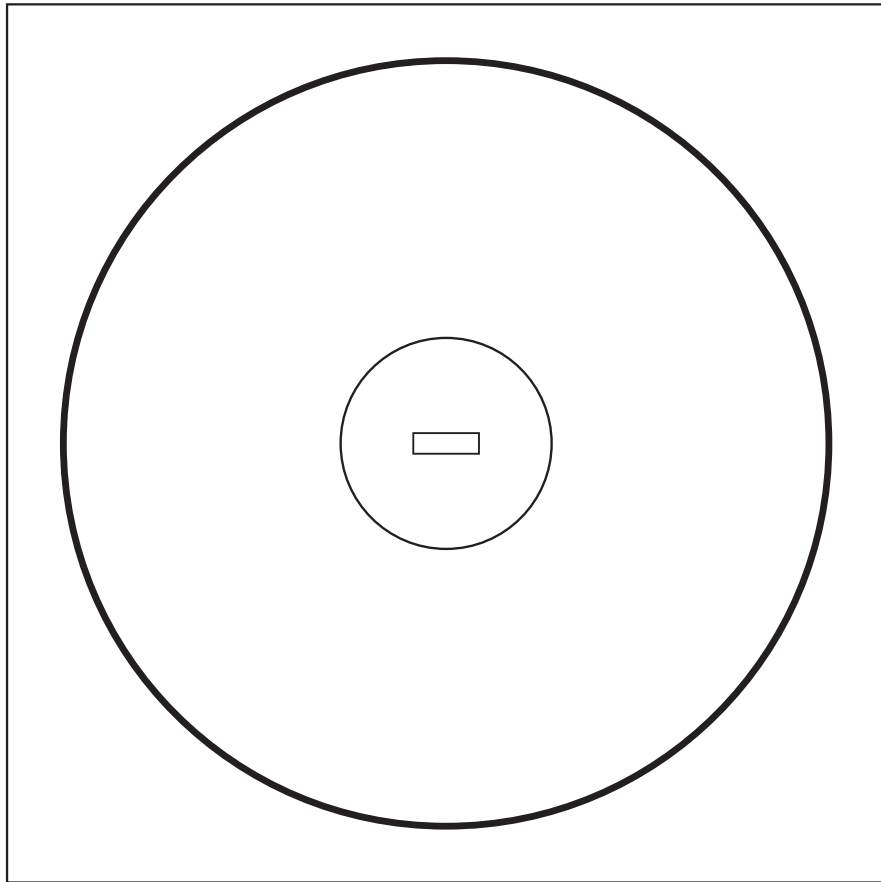

Wrestling Mat – The use of the Pac-12 Conference mark is required in the wrestling facility beginning in the 2012-2013 academic year.

Per the diagram on this page, Pac-12 signage in institutional colors shall appear in front of the judges' table. If the event is televised, the signage must be oriented towards the television cameras.

Additional usage within the wrestling facility is encouraged but not required. Utilization of the primary mark (blue gradient) is recommended in such instances.

*Signage to be provided by the Conference office.

ROWING

The Shell – The use of the Pac-12 Conference mark is required on the shell beginning in the 2012-2013 academic year.

Per the diagram on this page, the mark shall appear on the front or the back end of the shell in institutional colors.

Additional usage throughout the rowing venue is encouraged but not required. Utilization of the primary mark (blue gradient) is recommended in such instances.

*Decal for the shell to be provided by the Conference office.

