



**Central
Hockey
League**

**Official Rules
2005-2006**

4909 East McDowell Rd., Suite 104
Phoenix, AZ 85008
Phone: (480) 949-8600 • Fax: (480) 949-8616
www.centralhockeyleague.com



© Copyright 2005 Central Hockey League

All rights reserved. The use of information contained in this book by members of the media is encouraged. The use of any part of this publication reproduced, transmitted in any form or by any means, electronic, mechanical, photocopying, recording, or otherwise stored in a retrieval system, without the prior written consent of the Central Hockey League is an infringement of copyright law.

Printed in Canada

Project management: Dan Diamond and Associates, Inc., Toronto, Ontario

**CENTRAL HOCKEY LEAGUE
OFFICIAL RULES
2005-06**



TABLE OF CONTENTS

	PAGE
Alphabetical Rules Index	4
Rink Diagram	8
Goal Crease Dimensions	9
Face-Off Configuration	9
Approved Goal Frame	9
CHL Official Rules	10
Section One The Rink	10
Section Two Teams	16
Section Three Equipment	24
Section Four Penalties	32
Section Five Officials	49
Section Six Playing Rules	58
2005-06 CHL Schedule	110
2005-06 CHL Team Directory	122

NOTE: "President" in these playing rules shall mean President of the Central Hockey League or any League Officer designated by him to perform duties and exercise authority set out in these rules.

Rules reproduced with permission of the
National Hockey League © September 2005.

ALPHABETICAL INDEX

Abuse of Officials and Other Misconduct	Rule 41
Adjustment of Clothing and Equipment.....	Rule 42
Appointment of Officials	Rule 34
Attempt to or Deliberate Injury of Opponents	Rule 43
Awarded Goals.....	Rule 51 (c)
see also	Rule 30 (b), Rule 67 (h), Rule 72 (n)
	Rule 88 (a), Rule 91 (c)
Bench Minor Penalties.....	Rule 26 (b)
Blue Lines	Rule 5
Boarding	Rule 44
Broken Stick	Rule 45
Butt-Ending	Rule 46
Calling of Penalties	Rule 33
Captain of Team	Rule 14
Center Ice Spot and Circle	Rule 6
Change of Players.....	Rule 17
see also	Rule 51 (e)
Charging.....	Rule 47
Charging the Goalkeeper.....	Rule 47 (c)
see also.....	Rule 78
Checking from Behind	Rule 48
Clipping	Rule 49 (d)
Coincident Major Penalties	Rule 27 (c)
Coincident Minor Penalties	Rule 26 (d)
Composition of Team.....	Rule 13
Cross-Checking.....	Rule 50
Dangerous Equipment.....	Rule 23
Delayed Off-Sides	Rule 74 (a)
see also	Rule 75 (f), Rule 77 (c)
Delayed Penalties	Rule 32
Delaying the Game	Rule 51
see also.....	Rule 42 (a,d), Rule 55, Rule 59
	Rule 79 (b), Rule 87 (e,f)
Deliberate Illegal Substitution.....	Rule 17
Diving.....	Rule 52
Dimensions of Rink.....	Rule 2
Dislodging Net from Moorings.....	Rule 51 (c)
Disallowed Goals.....	Rule 11 (c), Rule 15 (b)
see also	Rule 57 (c)(d)(e)(g)(h), Rule 59 (e)
	Rule 70 (a)(c), Rule 72 (q)(r)
	Rule 78 (a)(b)(d)(e)(g)(h)(j)(l)
	Rule 93 (d)
Disputes with Officials.....	Rule 41 (c)
Division of Ice Surface.....	Rule 5

Diving	Rule 41 (o)
Elbowing.....	Rule 53
End Zone Face-Off Spots and Circles	Rule 8
Face Guards	Rule 21
see also.....	Rule 23
Face-Off Configuration	Page 9
Face-Off Spots in Neutral Zone	Rule 7
Face-Offs	Rule 54
Falling on Puck.....	Rule 55
see also.....	Rule 59
Fisticuffs.....	Rule 56
see also	Rule 41 (e, f), Rule 52 (a), Rule 72
Forfeiting a Game	Rule 35 (q)
see also.....	Rule 83
Game Line-up	Rule 15
Game Misconducts.....	Rule 28
Game Timekeeper.....	Rule 40
Goal Crease.....	Rule 4
see also.....	Rule 78
Goal Crease Diagram	Page 9
Goal Frame Diagram	Page 9
Goal Judge	Rule 37
Goal Posts and Nets.....	Rule 3
Goalkeeper – Outside the Crease.....	Rule 47 (c)
see also.....	Rule 78
Goalkeeper – Substitute.....	Rule 15
see also	Rule 18, Rule 31
Goalkeeper’s Equipment	Rule 21
see also	Rule 42 (c)
Goalkeeper’s Penalties	Rule 31
Goals and Assists	Rule 57
Gross Misconduct.....	Rule 28
see also.....	Rule 58
Handling Puck with Hands.....	Rule 59
Head-Butting	Rule 60
Helmet	Rule 22
High Sticks.....	Rule 61
Holding an opponent	Rule 62
Holding an opponent’s sticks	Rule 63
Hooking	Rule 64
Ice Cleaning	Rule 87 (d)
see also	Rule 90 (c)
Ice Surface	Rule 1
Icing the Puck	Rule 65
Icing the Puck – Unnecessary Contact.....	Rule 44 (a)
Illegal Puck	Rule 66
Injured Players.....	Rule 18

Intentional Off-Sides	Rule 74 (b)
see also	Rule 77 (c)
Interference	Rule 67
see also	Rule 88 (a)
Interference by/with Spectators	Rule 68
Interference with Goalkeeper	Rule 78
Kicking a Player	Rule 69
Kicking the Puck	Rule 70
Kneeing	Rule 71
Leaving Players' or Penalty Bench	Rule 72
see also	Rule 41 (b)
Linesmen	Rule 36
Lineup – Game	Rule 15
Lineup – Starting	Rule 16
Major Penalties	Rule 27
Masks	Rule 21
see also.....	Rule 23
Match Penalties	Rule 29
see also.....	Rule 43, Rule 52, Rule 69
Minor Penalties	Rule 26
Misconduct Penalties	Rule 28
Obscene Language or Gestures	Rule 73
Official Scorer	Rule 39
see also	Rule 57
Off-Side	Rule 74
see also	Rule 75, Rule 77
Overtime.....	Rule 89
Passes	Rule 75
Penalties	Rule 25
Penalties – Automatic expiry	Rule 26
Penalty Bench	Rule 10
see also	Rule 72
Penalty Shot	Rule 30
see also	Rule 15 (f), Rule 17 (b), Rule 26(c)
Rule 51 (c,d), Rule 55 (c), Rule 59 (d)	
Rule 67 (l), Rule 72 (m), Rule 88 (a,b)	
Rule 91 (b)	
Penalty Timekeeper	Rule 38
see also.....	Rule 72 (l)
Physical Abuse of Officials	Rule 76
Players' Benches	Rule 9
see also	Rule 72
Players' Jerseys.....	Rule 24A
Players in Uniform	Rule 15
Police Protection	Rule 12
Preceding Puck into Attacking Zone	Rule 77
Pre-Game Warm-Up	Rule 87 (c)

Profane Language	Rule 73
see also	Rule 41 (a,h,i)
Protection of Goalkeeper	Rule 78
Protective Equipment	Rule 22
Puck	Rule 24
Puck – Illegal	Rule 66
Puck Out of Bounds or Unplayable	Rule 80
Puck Must Be Kept in Motion	Rule 79
see also	Rule 55, Rule 59
Puck Out of Sight	Rule 81
Puck Striking Official	Rule 82
Referee	Rule 35
Referee’s Crease	Rule 10
see also	Rule 41 (m)
Refusing to Start Play	Rule 83
see also	Rule 87 (e)
Rink	Rule 1
Rink Diagram	Page 8
Rink Dimensions	Rule 2
Roughing	Rule 84
Signal and Timing Devices	Rule 11
Skates	Rule 20
Slashing	Rule 85
Slow Whistle.....	Rule 74
see also	Rule 75 (f), Rule 77
Spearing	Rule 86
Standing in Goal Crease	Rule 78 (b)
Start of Game and Periods	Rule 87
Starting Line-Up	Rule 16
Statistician.....	Rule 40A
Sticks.....	Rule 19
Supplementary Discipline	Rule 33A
Suspension – Exhibition Games	Rule 33B
Throwing Stick	Rule 88
see also.....	Rule 67
Throwing Objects onto the ice.....	Rule 41 (k)
see also.....	Rule 45 (c), Rule 68 (c)
Tied Game	Rule 89
Time of Match	Rule 90
Time-Outs.....	Rule 92
Tripping	Rule 91
Uniforms.....	Rule 13
Unsportsmanlike Conduct.....	Rule 41

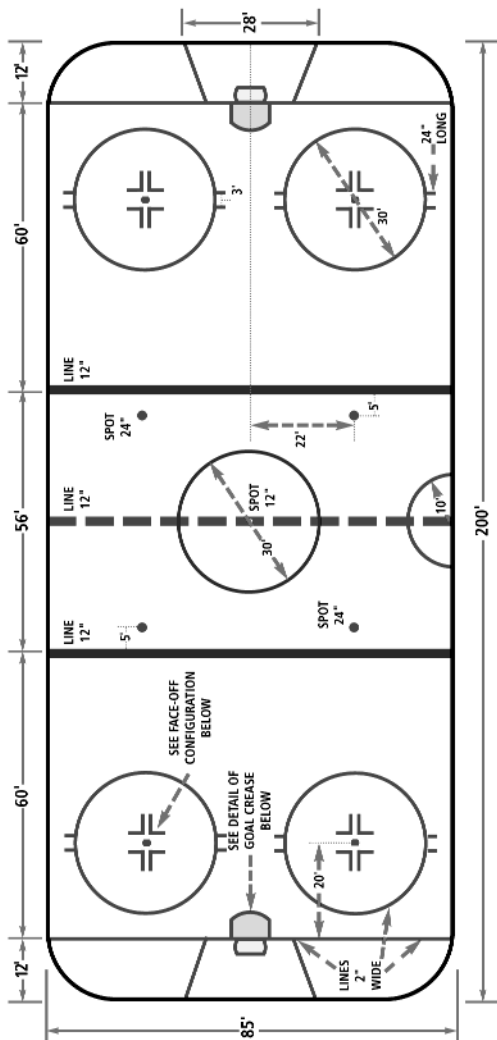

OFFICIAL DIMENSIONS OF RINK SURFACE



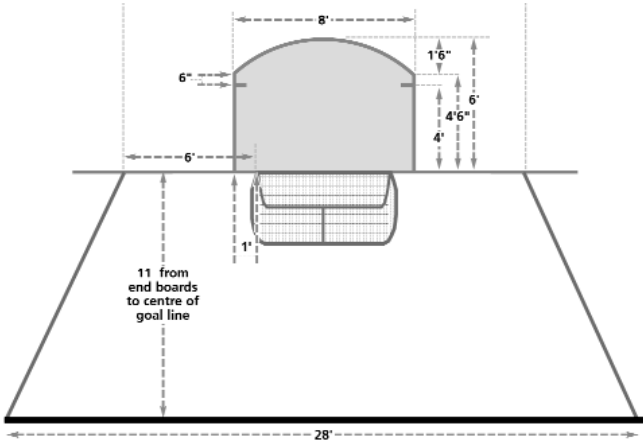

DETAIL OF GOAL CREASE

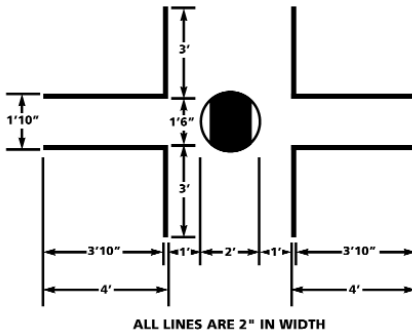

FACE-OFF CONFIGURATION

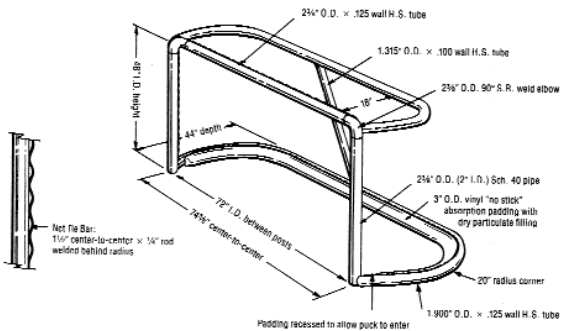

APPROVED GOAL FRAME

RULES GOVERNING THE GAME OF ICE HOCKEY

SECTION ONE – THE RINK

Rule 1. Rink

The game of "Ice Hockey" shall be played on an ice surface known as the "RINK".

(NOTE) There shall be no markings on the ice except as provided under these rules without the express written permission of the League. On-ice logos must not interfere with any official game markings.

Rule 2. Dimensions of Rink

- (a) The official size of the rink shall be two hundred feet (200') long and eighty-five feet (85') wide. The corners shall be rounded in the arc of a circle with a radius of twenty-eight feet (28').

The rink shall be surrounded by a wooden or fiber-glass wall or fence known as the "boards" which shall extend not less than forty inches (40") and not more than forty-eight inches (48") above the level of the ice surface. The ideal height of the boards above the ice surface shall be forty-two inches (42"). Except for the official markings provided for in these rules, the entire playing surface and the boards shall be white in color except the kick plate at the bottom of the boarding which shall be light yellow in color.

Any variations from any of the foregoing dimensions shall require official authorization by the League.

- (b) The boards shall be constructed in such a manner that the surface facing the ice shall be smooth and free of any obstruction or any object that could cause injury to players.

All doors giving access to the playing surface must swing away from the ice surface.

All glass or other types of protective screens and gear to hold them in position shall be properly padded or protected. Protective glass shall be required in front of the penalty benches to provide for the safety of the players on and off the ice. All equipment used to hold the glass or screens in position shall be mounted on the boards on the side away from the playing surface.

- (c) Spectator netting shall be hung in the ends and corners of the arena, of a height, type, and in a manner approved by the League.

Rule 3. Goal Posts and Nets

- (a) Twelve feet (12') from each end of the rink and in the center of a red line two inches (2") wide drawn completely across the width of the ice and continued vertically up the side of the boards, regulation goal posts and nets shall be set in such a manner as to remain stationary during the progress of a game. The goal posts shall be kept in position by means of flexible pegs affixed in the ice or floor. The flexible pegs shall be ten inches (10") in length.
- (b) The goal posts shall be of approved design and material, extending vertically four feet (4') above the surface of the ice and set six feet (6') apart measured from the inside of the posts. A crossbar of the same material as the goal posts shall extend from the top of one post to the top of the other.
- (c) There shall be attached to each goal frame a net of approved design made of white nylon cord which shall be draped in such a manner as to prevent the puck coming to rest on the outside of it, yet strung in a manner that will keep the puck in the net.

A skirt of heavy white nylon fabric or heavyweight white canvas shall be laced around the base plate of the goal frame in such a way as to protect the net from being cut or broken. This protective padding must be attached in a manner that will not restrict the puck from completely crossing the goal line. This padding must be set back a minimum of six inches (6") from the inside of the goal post. This skirt shall not project more than one inch (1") above the base plate.

(NOTE) The frame of the goal shall be draped with a nylon mesh net so as to completely enclose the back of the frame. The net shall be made of three-ply twisted twine (0.197 inch (5 mm) diameter) or equivalent braided twine of multifilament white nylon with an appropriate tensile strength of 700 pounds. The size of the mesh shall be two and one-half inches (2-1/2") (inside measurement) from each knot to each diagonal knot when fully stretched. Knotting shall be made as to ensure no sliding of the twine. The net shall be laced to the frame with medium white nylon cord no smaller in size than No. 21.

- (d) The goal posts and cross bar shall be painted in red and all other exterior surfaces shall be painted in white.
- (e) The red line, two inches (2") wide, between the goal posts on the ice and extended completely across the rink, shall be known as the "GOAL LINE".

Rule 4. Goal Crease

- (a) In front of each goal, a "GOAL CREASE" area shall be marked by a red line two inches (2") in width.
- (b) The goal crease shall be laid out as follows: One foot (1') outside of each goal post a two inch (2") line shall be painted extending four feet, six inches (4' 6") in length. These lines shall be at right angles to the goal line. A semi-circle line six feet (6') in radius and two inches (2") in width shall be drawn using the center of the goal line as the center point and connecting both ends of the side of the crease. On the side of the crease lines, four feet (4') from the goal line, extend a five inch (5") line into the crease. (See diagram on page 9).
- (c) The goal crease area shall include all the space outlined by the crease lines and extending vertically four feet (4') to the level of the top of the goal frame. The area outlined by the crease line and the goal line shall be painted a light blue color. (Paint code PMS 298.)
- (d) The area inside the goal frame to the goal line shall be painted a gloss white color.
- (e) A restricted trapezoid shaped area behind the goal will be laid out as follows: Five feet (5') outside of each goal crease (six feet (6') from each goal post), a two inch (2") red line shall be painted extending from the goal line to a point on the end of the rink ten feet (10') from the goal crease (eleven feet (11') from the goal post) (twenty-eight feet (28') in width) and continuing vertically up the boards (see diagram on page 9). (Paint code PMS 186).

NEW

Rule 5. Division of Ice Surface

- (a) The ice area between the two goals shall be divided into three parts by lines, twelve inches (12") in width, and blue in color, drawn sixty feet (60') out from the goal lines, and extended completely across the rink, parallel with the goal lines, and continued vertically up the side of the boards. (Paint code PMS 286.)
- (b) That portion of the ice surface in which the goal is situated shall be called the "DEFENDING ZONE" of the Team defending that goal; the central portion shall be known as the "NEUTRAL ZONE", and the portion farthest from the defended goal as the "ATTACKING ZONE".
- (c) There shall also be a line, twelve inches (12") in width and red in color, drawn completely across the rink in center ice, parallel with the goal lines and continued vertically up the side of the boards, known as the "CENTER LINE". This line shall contain regular interval

markings of a uniform distinctive design, which will readily distinguish it from the two blue lines...the outer edges of which must be continuous. (Paint code PMS 186.)

Rule 6. Center Ice Spot and Circle

A circular blue spot, twelve inches (12") in diameter, shall be marked exactly in the center of the rink; and with this spot as a center, a circle of fifteen feet (15') radius shall be marked with a blue line two inches (2") in width. (Paint code PMS 186.)

Rule 7. Face-off Spots in Neutral Zone

Two red spots two feet (2') in diameter shall be marked on the ice in the neutral zone five feet (5') from each blue line. Within the face-off spot, draw two parallel lines three inches (3") from the top and bottom of the spot. The area within the two lines shall be painted red, the remainder shall be painted white. The spots shall be forty-four feet (44') apart and each shall be a uniform distance from the adjacent boards.

Rule 8. End Zone Face-off Spots and Circles

- (a) In both end zones and on both sides of each goal, red face-off spots and circles shall be marked on the ice. The face-off spots shall be two feet (2') in diameter. Within the face-off spot, draw two parallel lines three inches (3") from the top and bottom of the spot. The area within the two lines shall be painted red, the remainder shall be painted white.

The circles shall be two inches (2") wide with a radius of fifteen feet (15') from the center of the face-off spots. At the outer edge of both sides of each face-off circle and parallel to the goal line shall be marked two red lines, two inches (2") wide and two feet (2') in length and three feet (3') apart.

One foot (1') away from the outer edge of the face-off spot, two lines shall be drawn parallel with the sideboards that shall be four feet (4') in length and eighteen inches (18") apart. Parallel to the end boards, commencing at the end of the line nearest to the face-off spot, a line shall extend two feet ten inches (2' 10") in length. All lines shall be two inches (2") in width. (See diagram on page 9.)

- (b) The location of the face-off spots shall be fixed in the following manner:

Along a line twenty feet (20') from each goal line and parallel to it, mark two points twenty-two feet (22') on

both sides of the straight line joining the center of the two goals. Each such point shall be the center of a face-off spot and circle. (See diagram on page 9.)

Rule 9. Players' Benches

- (a) Each rink shall be provided with seats or benches for the use of players of both Teams. The accommodations provided, including benches and doors shall be uniform for both Teams. Such seats or benches shall have accommodation for at least fourteen (14) persons of each Team. The benches shall be placed immediately alongside the ice, as near to the center of the rink as possible. Two doors for each bench must be uniform in location and size and as convenient to the dressing rooms as possible.

Each players' bench should be twenty-four feet (24') in length and when situated in the spectator area, they shall be separated from the spectators by a protective glass of sufficient height so as to afford the necessary protection for the players. The players' benches shall be on the same side of the playing surface opposite the penalty bench and should be separated by a substantial distance, if possible.

(NOTE) Each players' bench shall have two doors which must be uniform in location and size. ("Mirrored image benches"). All doors opening to the playing surface shall be constructed so that they swing inward.

- (b) No one but players in uniform, the Manager, Coach and Trainer shall be permitted to occupy the benches so provided, unless approved by the Central Hockey League.
-

Rule 10. Penalty Bench

- (a) Each rink must be provided with benches or seats to be known as the "PENALTY BENCH". These benches or seats must be capable of accommodating a total of ten (10) persons including the Penalty Timekeepers. Separate penalty benches shall be provided for each Team and they shall be situated on opposite sides of the Timekeeper's area, directly across the ice from the players' benches. The penalty bench(es) must be situated in the neutral zone.
- (b) On the ice immediately in front of the Penalty Timekeeper's seat there shall be marked in red on the ice a semi-circle of ten foot (10') radius and two inches (2") in width which shall be known as the "REFEREE'S CREASE".
- (c) Each Penalty Bench shall be protected from the specta-
-

tor area by means of a glass partition which shall not be less than five feet (5') above the height of the boards.

Rule 11. Signal and Timing Devices

- (a) Each rink must be provided with a siren, or other suitable sound device, for the use of Timekeepers.
- (b) Each rink shall be provided with some form of electrical clock for the purpose of keeping the spectators, players and game officials accurately informed as to all time elements at all stages of the game including the time remaining to be played in any period and the time remaining to be served by at least five (5) penalized players on each Team.

Time recording for both game time and penalty time shall show time remaining to be played or served.

The game time clock shall measure the time remaining in tenths of a second during the last minutes of each period.

- (c) Behind each goal, electrical lights shall be set up for the use of the Goal Judges. A red light will signify the scoring of a goal and a green light will signify the end of a period or a game.

(NOTE) A goal cannot be scored when a green light is showing.

Rule 12. Police Protection

All clubs shall provide adequate police or other protection for all players and Officials at all times.

The Referee shall report to the President any failure of this protection observed by him or reported to him with particulars of such failure.

SECTION TWO – TEAMS

Rule 13. Composition of Team

- (a) A Team shall be composed of eighteen (18) players (sixteen (16) skaters and two (2) goalkeepers as per Rule 15 (a)(c)(d) – Players in Uniform) who shall be under contract to the Club they represent.
- (b) Each player and each goalkeeper listed in the line-up of each Team shall wear an individual identifying number at least ten inches (10") high on the back of his sweater. Sweater numbers e.g. 00, 1/2 (fractions), .05 (decimals), 101 (three digit) are not permitted. In addition, each player and goalkeeper shall wear his surname in full, in block letters three inches (3") high, across the back of his sweater at shoulder height.

All players of each Team shall be dressed uniformly with approved design and color of their helmets, sweaters, short pants, stockings and skates.

Altered uniforms of any kind, i.e. Velcro inserts, oversized jerseys, altered collars, etc. will not be permitted. Any player or goalkeeper not complying with this Rule shall not be permitted to participate in the game. See also Rule 21 – Goalkeeper's Equipment.

Each Member Club shall design and wear distinctive and contrasting uniforms for their home and road games, no parts of which shall be interchangeable except the pants.

Rule 14. Captain of Team

- (a) One Captain shall be appointed by each Team, and he alone shall have the privilege of discussing with the Referee any questions relating to interpretation of rules which may arise during the progress of a game. He shall wear the letter "C", approximately three inches (3") in height and in contrasting color, in a conspicuous position on the front of his sweater.

In addition, if the permanent Captain is not on the ice, Alternate Captains (not more than two) shall be accorded the privileges of the Captain. Alternate Captains shall wear the letter "A" approximately three inches (3") in height and in contrasting color, in a conspicuous position on the front of their sweaters.

(NOTE) Only when the captain is not in uniform, the Coach shall have the right to designate three (3) Alternate Captains. This must be done prior to the start of the game.

- (b) The Referee and Official Scorer shall be advised prior to the start of each game, the name of the Captain and the Alternate Captains of both Teams.

- (c) Only the Captain, when invited to do so by the Referee, shall have the privilege of discussing any point relating to the interpretation of rules. Any Captain or player who comes off the bench and makes any protest or intervention with the Officials for any purpose shall be assessed a minor penalty for unsportsmanlike conduct under Rule 41(b) – Abuse of Officials. Should this protest continue, he may be assessed a misconduct penalty, and if it further continues, a game misconduct penalty shall be warranted.

A complaint about a penalty is NOT a matter "relating to the interpretation of the rules" and a minor penalty shall be imposed against any Captain or other player making such a complaint.

- (d) No goalkeeper shall be permitted to act as Captain or Alternate Captain.

Rule 15. Players in Uniform

- (a) At the beginning of each game, the Manager or Coach of each Team shall list the players and goalkeepers who shall be eligible to play in the game. Not more than eighteen (18) players, including goalkeepers, shall be permitted.
- (b) A list of names and numbers of all eligible players and goalkeepers must be handed to the Referee or Official Scorer before the game, and no change shall be permitted in the list or addition thereto shall be permitted after the commencement of the game.
- i) If a goal is scored when an ineligible player is on the ice, the goal will be disallowed.
 - ii) The ineligible player will be removed from the game and the club shall not be able to substitute another player from its roster. Only players on the list submitted to the Referee or Official Scorer before the game may participate in the game.
 - iii) The determining factor when considering whether or not a player is ineligible is that his name and not necessarily his number must be correctly listed by the Manager or Coach of that Team.
- (c) Each Team shall be allowed one goalkeeper on the ice at one time. The goalkeeper may be removed and another player substituted. Such substitute shall not be permitted the privileges of the goalkeeper.
- (d) Each Team shall have on its bench, or on a chair immediately beside the bench, a substitute goalkeeper who shall, at all times, be fully dressed and equipped ready to play.

The substitute goalkeeper may enter the game at any

time following a stoppage of play, but no warm-up shall be permitted.

- (e) Except when both goalkeepers are incapacitated, no player in the playing roster in that game shall be permitted to wear the equipment of the goalkeeper.
- (f) In regular League and Playoff games, if both listed goalkeepers are incapacitated, that Team shall be entitled to dress and play any available goalkeeper who is eligible. This goalkeeper is eligible to sit on the player's bench, in uniform. No delay shall be permitted in taking his position in the goal, and he shall be permitted a two-minute warm-up. However, the warm-up is not permitted in the event a goalkeeper is substituted for a penalty shot.

(NOTE) In the event that the two regular goalkeepers are injured in quick succession, the third goalkeeper shall be provided with a reasonable amount of time to get dressed, in addition to a two-minute warm-up.

- (g) The Referee shall report to the President for disciplinary action any delay in making a substitution of goalkeepers.
-

Rule 16. Starting Line-Up

- (a) Prior to the start of the game, at the request of the Referee, the Manager or Coach of the visiting Team is required to name the starting line-up to the Referee or Official Scorer. At any time in the game, at the request of the Referee made to the Captain, the visiting Team must place a playing line-up on the ice and promptly commence play.
 - (b) Prior to the start of the game, the Manager or Coach of the home Team, having been advised by the Official Scorer or the Referee the names of the starting line-up of the visiting Team, shall name the starting line-up of the home Team. This information shall be conveyed by the Official Scorer or the Referee to the Coach of the visiting Team.
 - (c) No change in the starting line-up of either Team as given to the Referee or Official Scorer, or in the playing line-up on the ice, shall be made until the game is actually in progress. For an infraction of this Rule, a bench minor penalty shall be imposed upon the offending Team, provided such infraction is called to the attention of the Referee before the second face-off in the first period takes place.
-

Rule 17. Change of Players

- (a) Players may be changed at any time from the players' bench provided that the player or players leaving the
-

ice shall be within five feet (5') of his players' bench and out of the play before the change is made.

If in the course of making a substitution, either the player entering the game or the player retiring from the ice surface plays the puck with his stick, skates or hands or who checks or makes any physical contact with an opposing player while either the player entering the game or the retiring player is actually on the ice, then the infraction of "too many men on the ice" will be called.

If in the course of a substitution either the player entering the play or the player retiring is struck by the puck accidentally, the play will not be stopped and no penalty will be called.

During the play, the player retiring from the ice must do so at the players' bench and not through any other exit leading from the rink. This is not a legal player change and therefore when a violation occurs, a bench minor penalty shall be imposed.

A goalkeeper may be changed for another player at any time under conditions set out in this section. The only exception to this provision is when a goalkeeper is removed for an extra attacker in regular season overtime. Any attempt by the goalkeeper to return to his position prior to the next stoppage of play (on the fly) shall be deemed to be an illegal substitution and a bench minor penalty shall be assessed for having an ineligible player. (See Rule 89 (NOTE 5)).

(NOTE 1) When a goalkeeper leaves his goal area and proceeds to his players' bench for the purpose of substituting another player, the skater cannot enter the playing surface before the goalkeeper is within five feet (5') of the bench. If the substitution is made prematurely, the official shall stop the play immediately unless the non-offending team has possession of the puck in which event the stoppage will be delayed until the puck changes hands.

There shall be no time penalty to the Team making the premature substitution, but the resulting face-off will take place at the center ice face-off spot when play is stopped beyond the center red line. When play is stopped prior to the center red line, the resulting face-off shall be conducted at the point where the play was stopped.

In all other situations not covered in the above, a minor penalty may result for Too Many Men on the Ice.

(NOTE 2) The Referee shall request that the public address announcer make the following announcement: "Play has been stopped due to premature substitution for the goalkeeper."

(NOTE 3) Goalkeepers' substitution during a game will be conducted within the same time frame as a regular line change. No

extra time will be allotted to the goalkeeper coming off the bench, except in the case where an injury to a goalkeeper occurs.

- (b) If by reason of insufficient playing time remaining, or by reason of penalties already imposed, a bench minor penalty is imposed for deliberate illegal substitution (too many men on the ice) which cannot be served in its entirety within the legal playing time, or at any time in overtime, a penalty shot shall be awarded against the offending Team.
- (c) A player serving a penalty on the penalty bench, who is to be changed after the penalty has been served, must proceed at once by way of the ice and be at his own players' bench before any change can be made.

For any violation of this Rule, a bench minor penalty shall be imposed.

- (d) Following the stoppage of play, the visiting Team shall promptly place a line-up on the ice ready for play and no substitution shall be made from that time until play has been resumed. The home Team may then make any desired substitution which does not result in the delay of the game.

(NOTE 1) "Placing a line-up on the ice" shall mean that both teams shall place the full compliment of players (and not exceed) to which they are entitled within the line change time frame.

If there is any undue delay by either Team in changing players, the Referee shall order the offending Team or Teams to take their positions immediately and not permit any further player changes.

(NOTE 2) When a substitution has been made under the above Rule, no additional substitution may be made until play commences.

- (e) Following a stoppage of play, the Referee will enforce the following line change procedure once he has determined that this procedure may begin:
 - (1) The Referee shall give the visiting Team up to five (5) seconds to make their line change.
 - (2) The Referee shall raise his hand to indicate no further changes by the visiting Team and to commence the home Team's line change.
 - (3) The Referee shall give the home Team up to eight (8) seconds to make their line change.
 - (4) The Referee shall lower his hand to indicate no further changes by the home Team.
 - (5) Any attempt by the either Team to make a change after the Referee's signal, attempt to place too many men on the ice for the subsequent line change, or attempt to make additional personnel changes, shall not be permitted and the Referee

will send the players who have attempted to change back to their players' bench. The Referee will then issue a warning to the offending Team (through the Coach) indicating that any subsequent violations during the rest of the game (including overtime), shall result in a bench minor penalty for delaying the game. This penalty shall be announced as a "Bench Minor Penalty for Delay of Game – Improper Line Change".

(6) The Linesman conducting the face-off will blow his whistle (once the Referee has lowered his hand for the line changes) to indicate that all players must be in position and on-side for the face-off within five (5) seconds. The face-off will then be conducted in accordance with Rule 54 – Face-Offs.

(7) Players who are slow (after the five second warning whistle given by the Linesman) getting to the face-off location or who are in an off-side position for the ensuing face-off will be warned once in the game by the Referee. This warning will also be given to the offending Team's Coach. Any subsequent violation shall result in a bench minor penalty for delay of game being assessed to the offending Team.

NEW

(8) In the last two (2) minutes of regulation time and anytime in the overtime period(s), points 6 and 7 above are not applicable. The Linesman shall give the teams a reasonable amount of time to set up for the ensuing face-off after points 1 through 5 above have been enforced.

Players must proceed directly to the location of the face-off to participate in the ensuing face-off. Any attempts to delay the game by stalling or otherwise unnecessary actions by either team shall result in the assessment of a bench minor penalty for delaying the game. This penalty shall be announced as a "Bench Minor Penalty for Delay of Game – Slow Proceeding to Face-Off Location (or, Slow Proceeding to Players' Bench)".

Rule 18. Injured Players

- (a) When a player other than a goalkeeper is injured or compelled to leave the ice during a game, he may retire from the game and be replaced by a substitute, but play must continue without the Teams leaving the ice.
- (b) If a goalkeeper sustains an injury or becomes ill, he must be ready to resume play immediately or be

replaced by a substitute goalkeeper and NO additional time shall be allowed by the Referee for the purpose of enabling the injured or ill goalkeeper to resume his position. The substitute goalkeeper shall be allowed a two (2) minute warm-up during all pre-season games. No warm-up shall be permitted for a substitute goalkeeper in all regular League or Playoff games. (See also Section (d).)

- (c) The Referee shall report to the President for disciplinary action any delay in making a goalkeeper substitution.

The substitute goalkeeper shall be subject to the regular rules governing goalkeepers and shall be entitled to the same privileges.

- (d) When a substitution for the regular goalkeeper has been made, such regular goalkeeper shall not resume his position until play has resumed.
- (e) If a penalized player has been injured, he may proceed to the dressing room without the necessity of taking a seat on the penalty bench. If the injured player receives a minor penalty, the penalized Team shall immediately put a substitute player on the penalty bench, who shall serve the penalty until such time as the injured player is able to return to the game. He would replace his teammate on the penalty bench at the next stoppage of play. If the injured player receives a major penalty, the penalized Team shall place a substitute player on the penalty bench before the penalty expires and no other replacement for the penalized player shall be permitted to enter the game except from the penalty bench. For violation of this Rule, a bench minor penalty shall be imposed.

Should the injured penalized player who has been replaced on the penalty bench return to his players' bench prior to the expiration of his penalty, he shall not be eligible to play until his penalty has expired. If, however, there is a stoppage of play prior to the expiration of his penalty, he must then replace his teammate on the penalty bench and return to play once his penalty has expired.

- (f) When a player is injured so that he cannot continue play or go to his bench, the play shall not be stopped until the injured player's Team has secured possession of the puck; if the player's Team is in possession of the puck at the time of injury, play shall be stopped immediately unless his Team is in a scoring position.

(NOTE) In the case where it is obvious that a player has sustained a serious injury, the Referee and/or Linesman may stop the play immediately.

- (g) When play has been stopped by the Referee or Linesman due to an injured player, or whenever an injured player is attended to on the ice by the Trainer or medical personnel, such player must be substituted for immediately (except goalkeeper). This injured player cannot return to the ice until play has resumed.

If when the attacking Team has control of the puck in its attacking zone, play is stopped by reason of any injury to a player of the defending Team, the ensuing face-off shall take place at one of the defending Team's end zone face-off spot.

SECTION THREE – EQUIPMENT

(NOTE 1) A request for a stick measurement shall be limited to one request per Team during the course of any stoppage in play.

(NOTE 2) Altered uniforms of any kind, e.g. Velcro inserts, oversized jerseys, etc., will not be permitted. Any player or goalkeeper not complying with these Rules shall not be permitted to participate in the game.

(NOTE 3) These equipment regulations are written in the spirit of "fair play". If at any time the CHL feels that this spirit is being abused, the offending equipment will be deemed ineligible for play until a hearing has ruled on its eligibility.

(NOTE 4) At random during the season, goalkeepers' and players' equipment may be checked by League staff.

Rule 19. Sticks

- (a) The sticks shall be made of wood or other material approved by the League Office, and must not have any projections. Adhesive tape of any color may be wrapped around the stick at any place for the purpose of reinforcement or to improve control of the puck. In the case of a goalkeeper's stick, there shall be a knob of white tape or some other protective material approved by the League. This knob must not be less than one-half inch (1/2") thick at the top of the shaft.

Failure to comply with this provision of the Rule will result in the goalkeeper's stick being deemed unfit for play. The goalkeeper's stick must be changed without the application of a minor penalty.

- NEW** (b) No stick shall exceed sixty-three inches (63") in length from the heel to the end of the shaft nor more than twelve and one-half inches (12-1/2") from the heel to the end of the blade.

(NOTE) Requests for an exception to the length of the shaft (only) may be submitted in writing to and must be approved by the League's Hockey Operations Department prior to any such stick being approved for use.

The blade of the stick shall not be more than three inches (3") in width at any point nor less than two inches (2"). The curvature of the blade of the stick shall have no restriction, and no measurement of the curvature will be permitted. All edges of the blade shall be beveled.

- (c) The blade of the goalkeeper's stick shall not exceed three and one-half inches (3-1/2") in width at any point except at the heel where it must not exceed four and one-half inches (4-1/2") in width; nor shall the goalkeeper's stick exceed fifteen and one-half inches (15-1/2") in length from the heel to the end of the blade.

There is to be no measurement of the curvature of the blade on the goalkeeper's stick. All other elements of the stick are subject to a measurement and the appropriate applicable penalty.

The widened portion of the goalkeeper's stick extending up the shaft from the blade shall not extend more than twenty-six inches (26") from the heel and shall not exceed three and one-half inches (3-1/2") in width.

- (d) A minor penalty shall be imposed on any player or goalkeeper who uses a stick not conforming to the provisions of this Rule.

(NOTE 1) When a formal complaint is made by the Captain or Alternate Captain of a Team, against the dimensions of any stick, the Referee shall take the stick to the Timekeeper's bench where the necessary measurement shall be made immediately. The result shall be reported to the Penalty Timekeeper who shall record it on the back of the penalty record.

If the complaint is not sustained, a bench minor penalty shall be imposed against the complaining club.

(NOTE 2) A player who participates in the play, who checks or who intentionally prevents the movement of an opponent, or who intentionally plays the puck while carrying two sticks (including while taking a replacement stick to his goalkeeper) shall incur a minor penalty under this Rule. If his participation causes a foul resulting in a penalty, the Referee shall report the incident to the President for disciplinary action.

(NOTE 3) A request for a stick measurement in regular playing time or overtime is permitted. A request for a stick measurement following a goal in overtime is not permitted. Stick measurements prior to or during the shoot-out are not permitted.

- (e) Any player who deliberately breaks his stick or who refuses to surrender his stick for measurement when requested to do so by the Referee shall be assessed a minor penalty plus a ten (10) minute misconduct. In addition, this player shall be subject to a twenty-five dollar (\$25) fine.
- (f) When a formal complaint is made by the Captain or Alternate Captain of a Team, against the dimensions of any stick of an opponent, that opponent must be on the ice at the time the request is made to the Referee. Once the request is made, and as long as the officials maintain visual contact with the stick, it can be measured. This means that if a player whose stick is about to be measured steps off the ice onto his players' bench, his stick may still be measured provided that the request was received prior to him leaving the ice surface and the stick remains in the view of at least one of the On-Ice Officials.

Rule 20. Skates

- (a) All hockey skates shall be of a design approved by the League Office. All skates worn by players (but not goalkeepers) and by the Referee and Linesmen shall be equipped with an approved safety blade.

When the Referee becomes aware that any person is wearing a skate that does not have the approved safety blade, he shall direct that it be replaced immediately. If such replacement is not carried out, the Referee shall report the incident to the President for disciplinary action.

- (b) The use of speed skates or any skate so designed that it may cause injury is prohibited.
-

Rule 21. Goalkeeper's Equipment

- (a) With the exception of skates and stick, all the equipment worn by the goalkeeper must be constructed solely for the purpose of protecting the head or body, and he must not wear any garment or use any contrivance which would give him undue assistance in keeping goal.
- (b) The leg guards worn by goalkeepers shall not exceed twelve inches (12") in extreme width when on the leg of the player. The maximum length from bottom mid-point to top mid-point of the pad is not to exceed thirty-eight inches (38"). No attachments such as plastic puck foils are permitted. Calf protectors must follow the contour of the calf and ankle and can have a thickness of no greater than one and a half inches (1-1/2"). The minimum length of the boot of the pad is to be no less than seven inches (7"). The knee strap pad is not to exceed six inches (6") in length by five and one-half inches (5-1/2") in width by one and one-half (1-1/2") in thickness. All knee protection must be worn under the thigh guard of the pant.

(NOTE) At random during the season, goalkeeper's leg guards and gloves may be checked by League Staff. A member of the League Staff (Hockey Operations and/or Officiating Department) will request the equipment from the team. This equipment will be removed to a secure location for measuring.

Any violation of this Rule will result in an automatic one (1) game suspension for the next League game to the offending goalkeeper. Should both goalkeepers on a Club have illegal equipment, both will be suspended in sequence. The goalkeeper who played the day/night of the measurement will be suspended for the next game, and the back-up goalkeeper will be suspended for the

following game.

Refusal to submit the equipment for League measurement will result in the same sanctions as that of a goalkeeper with illegal equipment.

Any violation of this Rule shall be reported to the Club involved and to the President of the League.

(c) Chest and Arm Pads

- (i) No raised ridges are allowed on the front edges or sides of the chest pad, the inside or outside of the arms, or across the shoulders.
- (ii) Layering at the elbow is permitted to add protection but not to add stopping area. This layering, both across the front and down the sides, to protect the point of the elbow shall not exceed seven and one half inches (7-1/2").
- (iii) Shoulder Cap Protectors must follow the contour of the shoulder cap without becoming a projection/extension beyond or above the shoulder or shoulder cap. This contoured padding must not be more than one inch (1") in thickness beyond the top ridge of the shoulder and shoulder cap.
- (iv) On each side the Shoulder Clavicle Protectors are not to exceed seven inches (7") in width. Their maximum thickness is to be one inch (1"). This protection is not to extend or project above or beyond the shoulder or shoulder cap nor extend beyond the armpit. No insert is allowed between the Shoulder Clavicle Protector and the chest pad that would elevate the Shoulder Clavicle Protector.
- (v) If, when the goalie assumes his normal crouch position, the shoulder and/or shoulder cap protection is pushed above the contour of the shoulder, the chest pad will be considered illegal. (See Rule 23(a) – Dangerous Equipment)

(d) Pants

- (i) No internal or external padding is permitted on the pant leg or waist other than to provide protection.
- (ii) The maximum width (straight line) of the thigh pad across the front of the leg is eleven inches (11"). If the groin and/or hip pads extend beyond the edge of the front thigh pad they are to be included in this eleven-inch measurement. This measurement is to be taken while the goalie is in an upright standing position. This measurement is to be made five inches (5") up from the bottom of the pant.
- (iii) All knee protection must be strapped and fit under

the thigh pad of the pant leg and not exceed the eleven inches (11") allowed for the width of the thigh pad.

(e) Goalkeepers' Jerseys

(i) The maximum jersey size is (see below).

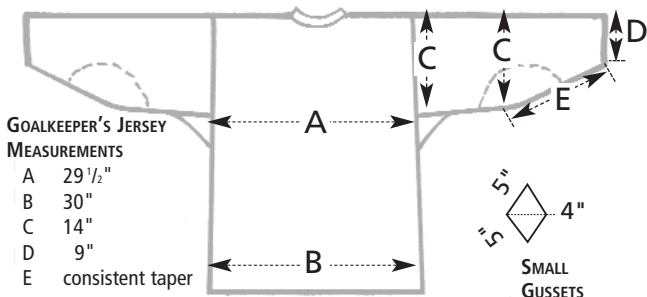

(ii) No inserts or additions are to be added to the standard goalie cut jersey as produced by the manufacturer. (Modifications at the manufacturer are not allowed unless approved in advance by the League) (see Rule 13(b) – Composition of Team).

(iii) No "tying down" of the jersey is allowed at the wrists if it creates a tension across the jersey such that a "webbing effect" is created in the armpit area.

(iv) No other tie downs are allowed that create a "webbing effect."

(v) The length of a jersey is illegal if it covers any area between the goalies' legs.

(f) Catching Glove:

(i) A maximum perimeter of forty-eight inches (48") is permitted. The perimeter of the glove is the distance around the glove. (See measurement procedures below)

(ii) The wrist cuff is to be a minimum of four-and-a-half inches (4-1/2") in height. The cuff of the glove is considered to be the portion of the glove protecting the wrist from the point where the thumb joint meets the wrist. Any protection join-

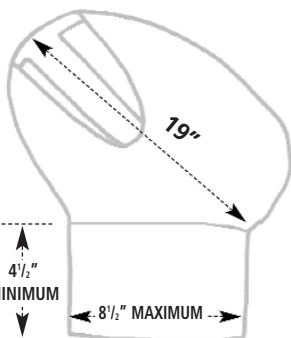

ing/enhancing the cuff to the glove will be considered part of the glove rather than the cuff.

- (iii) The wrist cuff is to be a maximum of eight and a half inches (8-1/2") in width (this includes the bindings). All measurements follow the contour of the cuff.
- (iv) The distance from the heel of the glove along the pocket and following the contour of the inside of the trap of the glove to the top of the "T" trap must not exceed nineteen inches (19"). The heel is considered to be the point at which the straight vertical line from the cuff meets the glove (see diagram above).
- (v) Measuring Procedures for Goalkeepers' Catching Glove

(a) Suggested Equipment - binder clip, pins and a 5/8" fiberglass cloth measuring tape that measures 1/8th of an inch.

(b) Procedure:

- (1) The tape is to be placed on the outside edge of the glove with the midway line of the tape following the top ridge of the edge/binding.



- (2) At the "starting point" of the measurement, anchor the tape with a pin or binder clip.
- (3) Ensure that the midpoint line of the measuring tape follows the outside top ridge of the edge/binding.
- (4) If at the junction of the cuff and catch portions of the glove there is a "jagged point"; the measurement tape will follow the imaginary perpendicular line to the glove ridge above. (A "jagged joint" anywhere else on the glove will not be allowed this "straight line" privilege, i.e. where the trap joins the main glove).

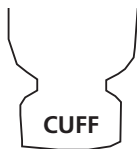

- (g) Blocking Glove:
 - (i) Protective padding attached to the back or forming part of the goalkeeper's blocking glove shall not exceed eight inches (8") in width nor more than sixteen inches (16") in length at any point (this includes the bindings). All measurements follow the contour of the back of the glove.

(ii) The blocking glove must be rectangular in shape.

(NOTE) All goaltenders must use one of each a blocking glove and catching glove, meeting League-approved sizing specifications.

(h) Protective masks of a design approved by the League Office may be worn by goalkeepers. Protective masks, deemed to be worn only to increase stopping area, will be considered illegal.

(NOTE) The Hockey Operations/Officiating Department is specifically authorized to make a check of each Teams' equipment to ensure the compliance with the Rule. It shall report its findings to the President for his disciplinary action.

Rule 22. Protective Equipment

(a) All protective equipment, except gloves, headgear and goalkeepers' leg guards must be worn under the uniform. For violation of this Rule, after warning by the Referee, a minor penalty shall be imposed.

(NOTE) Players including the goalkeeper violating this Rule shall not be permitted to participate in the game until such equipment has been corrected or removed.

(b) All players of both Teams shall wear a helmet of design, material and construction approved by the League Office at all times while participating in a game, either on the playing surface or the players' or penalty benches and during pre-game warm-up.

All players of both teams shall wear a half visor of design, material and construction approved by the League Office at all times while participating in a game, either on the playing surface or the players' or penalty benches and during pre-game warm-up. A player not wearing his helmet/visor in the proper manner will be issued one (1) warning during a game. A second warning during that game will result in a misconduct penalty to that player and a fine to the player for improper use (wear) of a helmet/visor.

When a goalkeeper has lost his helmet and/or face-mask and his Team has possession of the puck, the play shall be stopped immediately to allow the goalkeeper the opportunity to regain his helmet and/or face mask. When the opposing Team has possession of the puck, play shall only be stopped if there is no immediate and impending scoring opportunity. This stoppage of play must be made by the Referee. When play is stopped in the defending zone because the goalkeeper has lost his helmet and/or face mask, the ensuing face-off shall take

place at one of the defending Teams end zone face-off spots.

- (c) A glove from which all or part of the palm has been removed or cut to permit the use of the bare hand shall be considered illegal equipment and if any player wears such a glove in play, a minor penalty shall be imposed on him.

When a complaint is made under this Rule, and such complaint is not sustained, a bench minor penalty shall be imposed against the complaining club under Rule 51 – Delaying the Game.

Rule 23. Dangerous Equipment

- (a) The use of pads or protectors made of metal, or of any other material likely to cause injury to a player, is prohibited.

(NOTE) All elbow pads which do not have a soft protective outer covering of sponge rubber or similar material at least one-half inch (1/2") thick shall be considered dangerous equipment.

- (b) A mask or protector of a design approved by the League Office may be worn by a player who has sustained a facial injury.

In the first instance, the injured player shall be entitled to wear any protective device prescribed by the club doctor. If any opposing club objects to the device, it may record its objection with the President.

(NOTE) The Officiating Department is specifically authorized to make a check of each Team's equipment to ensure compliance with this Rule. It shall report its findings to the President for his disciplinary action.

Rule 24. Puck

- (a) The puck shall be made of vulcanized rubber, or other approved material, one inch (1") thick and three inches (3") in diameter and shall weigh between five and one-half ounces (5-1/2 oz.) and six ounces (6 oz.). All pucks used in competition must be approved by the League Office, and include the CHL official puck logo.
- (b) The home Team shall be responsible for providing an adequate supply of official pucks which shall be kept in a frozen condition. This supply of pucks shall be kept at the penalty bench under the control of one of the regular Off-Ice Officials or a special attendant.

Rule 24A. Players' Jerseys

- (a) The maximum jersey size is (see below).
- (b) No inserts or additions are to be added to the standard players' jersey as produced by the manufacturer. (Modifications at the manufacturer are not allowed unless approved in advance by the League) (see Rule 13(b) – Composition of Team).
- (c) No alteration of the neck opening is permitted.
- (d) Sleeves must extend into the cuff of the glove.
- (e) Jerseys must be "tied down" properly at all times.

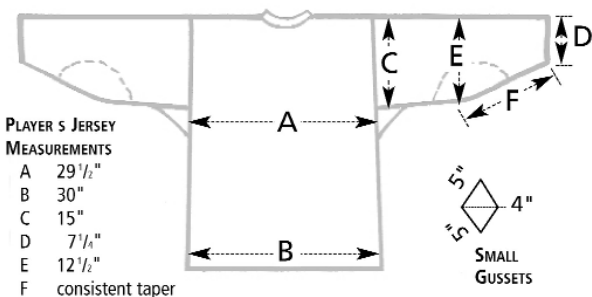

SECTION FOUR – PENALTIES

Rule 25. Penalties

Penalties shall be actual playing time and shall be divided in the following classes:

- (1) Minor penalties
- (2) Bench minor penalties
- (3) Major penalties
- (4) Misconduct penalties
- (5) Match penalties
- (6) Penalty shot

When coincident penalties are imposed on players of both Teams, the penalized players of the visiting Team shall take their positions on the penalty bench first in the place designated for visiting players.

(NOTE) When play is not actually in progress and an offense is committed by any player, the same penalty shall apply as though play was actually in progress.



Rule 26. Minor Penalties

- (a) For a "MINOR PENALTY", any player, other than a goalkeeper, shall be ruled off the ice for two (2) minutes during which time no substitute shall be permitted.
- (b) A "BENCH MINOR" penalty involves the removal from the ice of one (1) player of the Team against which the penalty is assessed for a period of two (2) minutes. Any player except a goalkeeper of the Team may be designated to serve the penalty by the Manager or Coach through the playing Captain and such player shall take his place on the penalty bench promptly and serve the penalty as if it was a minor penalty imposed upon him.
- (c) If while a Team is "short-handed" by one or more minor or bench minor penalties, the opposing Team scores a goal, the first of such penalties shall automatically terminate.

(NOTE) "Short-handed" means that the Team must be below the numerical strength of its opponents on the ice at the time the goal is scored. The minor or bench minor penalty which terminates automatically is the one with the least amount of time on the clock. Thus coincident minor penalties to both Teams do NOT cause either side to be "short-handed".

This Rule shall also apply when a goal is awarded.

This Rule does not apply when a goal is scored on a penalty shot (i.e. offending team's penalized player(s) do not get relesed on the scoring of a goal on a penalty shot.

Minor penalty expiration criteria:

- i) *Is the Team scored against short-handed?*
- ii) *Is the Team scored against serving a minor penalty on the clock?*

If both criteria are satisfied, the minor penalty with the least amount of time on the clock shall terminate except when coincidental penalties are being served.

When the minor penalties of two (2) players of the same Team terminate at the same time, the Captain of that Team shall designate to the Referee which of such players will return to the ice first and the Referee will instruct the Penalty Timekeeper accordingly.

When one player receives a major penalty and a minor penalty at the same time, the major penalty shall be served first by the penalized player, except under Rule 27(c) where coincidental major penalties are in effect, in which case the minor penalty will be recorded and served first.

- (d) When ONE minor penalty is assessed to ONE player of EACH Team at the same stoppage in play, these penalties will be served without substitution provided there are no other penalties in effect and visible on the penalty clocks. Both Teams will therefore play four skaters against four skaters for the duration of the minor penalties.

(NOTE) Should one or either of these players also incur a misconduct penalty in addition to their ONE minor penalty, this rule shall apply and teams would still play four skaters against four skaters (the player incurring the misconduct penalty would have to serve the entire 12 minutes – minor plus misconduct – and his team would have to place an additional player on the penalty bench to serve the minor penalty and be able to return to the ice when the minor penalty expires).

When multiple penalties are assessed to both teams, equal numbers of minor and major penalties shall be eliminated using the coincident penalty rule and any differential in time penalties shall be served in the normal manner and displayed on the penalty time clock accordingly. If there is no differential in time penalties, all players will still serve their allotted penalty time, but will not be released until the first stoppage of play following the expiration of their respective penalties.

Rule 27. Major Penalties

- (a) For the first "MAJOR PENALTY" in any one game, the

offender, except the goalkeeper, shall be ruled off the ice for five (5) minutes during which time no substitute shall be permitted.

- (b) For the third major penalty in the same game to the same player, or for a major for Butt-ending (Rule 46), Checking from Behind (Rule 48), Clipping (Rule 49), Cross-checking (Rule 50), Head-butting (Rule 60), Hooking (Rule 64), Kneeing (Rule 71), Slashing (Rule 85) or Spearing (Rule 86), he shall be ruled off the ice for the balance of the game, but a substitute shall be permitted to replace the player so suspended after five (5) minutes have elapsed. (Major penalty plus game misconduct with automatic fine of twenty-five dollars (\$25).)

The substitute is not required to take his place on the penalty bench immediately, but must do so at a stoppage of play prior to the expiration of the major penalty. He may then legally exit the penalty bench when the major penalty has expired. Failure to place a player on the penalty bench prior to the expiration of the major penalty will result in that team having to continue playing one player short (but not officially considered short-handed) until the next stoppage of play. Any replacement player who enters the game other than from the players' bench shall constitute an illegal substitution under Rule 17 – Change of Players calling for a bench minor penalty.

Furthermore, if the Team fails to place a player on the penalty bench to return to the ice at the end of the major penalty, they continue to play shorthanded but are NOT permitted to ice the puck as they are no longer shorthanded by reason of a penalty.

- (c) When coincident major penalties or coincident penalties of equal duration, including a major penalty, are imposed against players of both Teams, the penalized players shall all take their places on the penalty benches and such penalized players shall not leave the penalty benches until the first stoppage of play following the expiration of their respective penalties. Immediate substitutions shall be made for an equal number of major penalties, or coincident penalties of equal duration including a major penalty to each Team so penalized, and the penalties of the players for which substitutions have been made shall not be taken into account for the purpose of the Delayed Penalty Rule, (Rule 32).

Where it is required to determine which of the penalized players shall be designated to serve the delayed

penalty under Rule 32 – Delayed Penalties, the penalized Team shall have the right to make such designation not in conflict with Rule 26 – Minor Penalties.

- (d) During the last five (5) minutes of regulation time, or at any time in overtime, when a minor penalty (or double minor penalty) is assessed to one player of Team A, and a major (or match) penalty is assessed to one player of Team B on the same stoppage of play, the three (3) minute (or one (1) minute) differential shall be served immediately as a major penalty. This is also applicable when coincidental penalties are negated, leaving the aforementioned example. In such instances, the Team of the player receiving the major penalty must place the replacement player in the penalty bench prior to expiration of the penalty (in the case of a match penalty, the replacement player must enter the penalty bench immediately). The differential will be recorded on the penalty clock as a three (3) minute or a one (1) minute penalty (as applicable), and served in the same manner as a major penalty.
-

Rule 28. Misconduct Penalties

- (a) In the event of "MISCONDUCT" penalties to any players except the goalkeeper, the players shall be ruled off the ice for a period of ten (10) minutes each. A substitute player is permitted to immediately replace a player serving a misconduct penalty. A player whose misconduct penalty has expired shall remain in the penalty box until the next stoppage of play.

When a player receives a minor penalty and a misconduct penalty at the same time, the penalized Team shall immediately put a substitute player on the penalty bench and he shall serve the minor penalty without change.

When a player receives a major penalty and a misconduct penalty at the same time, the penalized Team shall place a substitute player on the penalty bench before the major penalty expires and no replacement for the penalized player shall be permitted to enter the game except from the penalty bench. Any violation of this provision shall be treated as an illegal substitution under Rule 17 – Change of Players, calling for a bench minor penalty.

- (b) A misconduct penalty imposed on any player at any time shall be accompanied with an automatic fine of fifteen dollars (\$15).
- (c) A "GAME MISCONDUCT" penalty involves the suspension of a player for the balance of the game but a sub-

stitute is permitted to replace immediately the player so removed. A player incurring a game misconduct penalty shall incur an automatic fine of twenty-five dollars (\$25) and the case shall be reported to the President who shall have full power to impose such further penalties by way of suspension or fine on the penalized player or any other player involved in the altercation.

- (d) The Referee may impose a "GROSS MISCONDUCT" penalty on any player, Manager, Coach or Trainer who is guilty of gross misconduct of any kind. Any person incurring a "gross misconduct" penalty shall be suspended for the balance of the game and shall incur an automatic fine of fifty dollars (\$50) and the case shall be referred to the President of the League for further disciplinary action.

(NOTE) For all game misconduct and gross misconduct penalties regardless of when imposed, a total of ten (10) minutes shall be charged in the records against the offending player.

- (e) In regular League games, any player who incurs a total of three (3) game misconduct penalties in the "General Category" and exclusive of other designated categories, shall be suspended for the next League game of his Team. For each subsequent game misconduct penalty, the automatic suspension shall be increased by one (1) game.

(NOTE) The "General Category" shall include the following infractions:

- (i) Charging – Rule 47(b)(c)
- (ii) Clipping – Rule 49(b)
- (iii) Elbowing – Rule 53(b)
- (iv) Fighting off the playing surface – Rule 56(c)
- (v) Head-butting – Rule 60(b)
- (vi) Inciting an opponent into incurring a penalty – Rule 41(g)
- (vii) Intervening in an altercation – Rule 56(d)
- (viii) Kneeing – Rule 71
- (ix) Not properly tied down during an altercation – Rule 56(a)
- (x) Obscene Language or Gestures – Rule 73(a)
- (xi) Persists in an altercation – Rule 56(f)
- (xii) Removing jersey prior to an altercation – Rule 56(a)
- (xiii) Resisting a Linesman in the discharge of his duties – Rule 41(f)
- (xiv) Secondary Altercation – Rule 56(a)(f)
- (xv) Third major penalty in a game – Rule 27(b)
- (xvi) Throwing stick outside the playing area – Rule 88(c)

In Playoff games, any player who incurs a total of two (2) game misconduct penalties in the "General Category" shall be suspended automatically for the next

Playoff game of his Team. For each subsequent game misconduct penalty during the Playoffs, the automatic suspension shall be increased by one (1) game.

Any request by a Club to have a game misconduct reviewed and rescinded by the League must submit their request in writing to the Hockey Operations Department with twenty-four (24) hours of the conclusion of the game in which the game misconduct was assessed. Failure to submit the written request within this timeframe will automatically result in the game misconduct being upheld and no further review of the incident will be considered or entertained. This does not apply to infractions addressed under Rule 33A – Supplementary Discipline.

- (f) In regular League games, any player who incurs a total of two (2) game misconduct penalties for Abuse of Officials related infractions penalized under Rule 41(a), (b) or (c) – Abuse of Officials and other Misconduct, shall be suspended automatically for the next League game of his Team. For each subsequent game misconduct penalty in this category, the automatic suspension shall be increased by one (1) game.
- (g) In regular League games, any player who incurs a total of two (2) game misconduct penalties for stick-related infractions shall be suspended automatically for the next League game of his Team. For each subsequent game misconduct penalty in this category, the automatic suspension shall be increased by one (1) game.

(NOTE) Stick-related infractions shall include the following infractions:

- (i) Butt-ending – Rule 46(b)
- (ii) Cross-checking – Rule 50(a)
- (iii) High-Sticking – Rule 61(b)
- (iv) Hooking – Rule 64(b)
- (v) Slashing – Rule 85(b)
- (vi) Spearing – Rule 86(b)

In Playoff games any player who incurs a total of two (2) game misconduct penalties for stick-related infractions shall be suspended automatically for the next Playoff game of his Team. For each subsequent game misconduct penalty in this category during the Playoffs the automatic suspension shall be increased by one (1) game.

- (h) In regular League games, any player who incurs a total of two (2) game misconduct penalties for Boarding – Rule 44(b), or Checking from Behind – Rule 48(a), shall be suspended automatically for the next League game of his Team. For each subsequent game misconduct penalty in this category, the automatic suspension

shall be increased by one (1) game.

In Playoff games any player who incurs a total of two (2) game misconduct penalties for boarding or checking from behind shall be suspended automatically for the next Playoff game of his Team. For each subsequent game misconduct penalty in this category during the Playoffs the automatic suspension shall be increased by one (1) game.

- (i) In regular League games, any player who incurs a total of three (3) misconduct or game misconduct penalties for instigator or three (3) game misconduct aggressor infractions shall be suspended automatically for the next League game of his Team. For each subsequent misconduct (instigator) or game misconduct penalty (instigator/aggressor), the automatic suspension shall be increased by one (1) game.

In Playoff games any player who incurs a total of two (2) misconduct or game misconduct penalties for instigator or two (2) game misconduct aggressor infractions shall be suspended automatically for the next Playoff game of his Team. For each subsequent game misconduct penalty (instigator/aggressor) during the Playoffs the automatic suspension shall be increased by one (1) game.

Prior to the commencement of each President's Cup Finals, a player will have his current stick-related, instigator, aggressor, fighting/general related, boarding and checking from behind game misconducts removed from his current playoff record. They will remain part of his historical record.

(NOTE) The automatic suspensions incurred under this subsection in respect to League games shall have no effect with respect to violations during playoff games.

Rule 29. Match Penalties

A "MATCH" penalty involves the suspension of a player for the balance of the game and the offender shall be ordered to the dressing room immediately. A substitute player is permitted to replace the penalized player after five (5) minutes playing time has elapsed when the penalty is imposed under Rule 43 – Attempt to or Deliberate Injury of Opponents.

(NOTE 1) The match penalty shall be served by a player to be designated by the Manager or Coach of the offending Team through the playing Captain, such player to take his place in the penalty box immediately.

For all match penalties, regardless of when imposed, or prescribed additional penalties, a total of ten (10) minutes shall be

charged in the records against the offending player.

(NOTE 2) When coincident match penalties have been imposed to a player on both Teams, Rule 27(c) covering coincident major penalties will be applicable with respect to player substitution.

(NOTE 3) The Referee is required to report all match penalties and the surrounding circumstances to the President of the League immediately following the game in which they occur.

Rule 30. Penalty Shot

- (a) Any infraction of the rules which calls for a "PENALTY SHOT" shall be taken as follows:

The Referee shall ask to have announced over the public address system the name of the player designated by him or selected by the Team entitled to take the shot (as appropriate). He shall then place the puck on the center face-off spot and the player taking the shot will, on the instruction of the Referee, play the puck from there and shall attempt to score on the goalkeeper. The puck must be kept in motion towards the opponent's goal line and once it is shot, the play shall be considered complete. No goal can be scored on a rebound of any kind (an exception being the puck off the goal post, then the goalkeeper and then directly into the goal), and any time the puck crosses the goal line, the shot shall be considered complete.

Only a player designated as a goalkeeper or alternate goalkeeper may defend against the penalty shot.

- (b) The goalkeeper must remain in his crease until the player taking the penalty shot has touched the puck and in the event of violation of this Rule or any foul committed by a goalkeeper, the Referee shall allow the shot to be taken and if the shot fails, he shall permit the penalty shot to be taken over again.

The goalkeeper may attempt to stop the shot in any manner except by throwing his stick or any object, in which case a goal shall be awarded.

(NOTE) See Rule 88.

- (c) In cases where a penalty shot has been awarded under Rule 51(c), deliberately displacing goal post during course of a breakaway; under Rule 67(i), Interference; under Rule 72(m), illegal entry into the game; under Rule 88(a) for throwing a stick; and under Rule 91(b), fouling from behind, the Referee shall designate the player who has been fouled as the player who shall take the penalty shot.

In cases where a player is fouled from behind (Rule 91(b)), four criteria must be met in order for the Referee to award a penalty shot:

1. The infraction must have taken place in the opponent's half of the ice, i.e. over the center red line;
2. The infraction must have been committed from behind;
3. The player in possession and control (or, in the judgment of the Referee, clearly would have obtained possession and control of the puck) must have been denied a reasonable chance to score

(NOTE) The fact that he got a shot off does not automatically eliminate this play from the penalty shot consideration criteria. If the foul was from behind and he was denied a "more" reasonable scoring opportunity due to the foul, then the penalty shot should be awarded), and;

4. The player in possession and control (or, in the judgment of the Referee who would have obtained possession and control) must have had no opposing player between himself and the goalkeeper.

In cases where a penalty shot has been awarded under Rule 17(b), deliberate illegal substitution with insufficient playing time remaining; under Rule 51(d), deliberately displacing goal post; under Rule 55(c), falling on the puck in the crease; under Rule 59(d), picking up the puck from the crease area, the penalty shot shall be taken by a player selected by the Captain of the non-offending Team from the players on the ice at the time when the foul was committed. Such selection shall be reported to the Referee and cannot be changed.

If by reason of injury, the player designated by the Referee to take the penalty shot is unable to do so within a reasonable time, the shot may be taken by a player selected by the Captain of the non-offending Team from the players on the ice when the foul was committed. Such selection shall be reported to the Referee and cannot be changed.

- (d) Should the player in respect to whom a penalty shot has been awarded himself commit a foul in connection with the same play or circumstances, either before or after the penalty shot has been awarded, be designated to take the shot, he shall first be permitted to do so before being sent to the penalty bench to serve the penalty except when such penalty is for a game misconduct, gross misconduct or match penalty in which case the penalty shot shall be taken by a player selected by the Captain of the non-offending Team from the players on the ice at the time when the foul was committed.

If at the time a penalty shot is awarded, the goalkeeper of the penalized Team has been removed from

the ice to substitute another player, the goalkeeper shall be permitted to return to the ice before the penalty shot is taken.

- (e) While the penalty shot is being taken, players of both sides shall withdraw to the sides of the rink and in front of their own player's bench.
- (f) If, while the penalty shot is being taken, any player of the opposing Team shall have by some action interfered with or distracted the player taking the shot and, because of such action, the shot should have failed, a second attempt shall be permitted and the Referee shall impose a misconduct penalty on the player so interfering or distracting.
- (g) If a goal is scored from a penalty shot, the puck shall be faced-off at center ice. If a goal is not scored, the puck shall be faced-off at either of the end face-off spots in the zone in which the penalty shot was tried.
- (h) Should a goal be scored from a penalty shot, a further penalty to the offending player shall not be applied unless the offense for which the penalty shot was awarded was such as to incur a major, match or misconduct penalty, in which case the penalty prescribed for the particular offense shall be imposed.

If the offense for which the penalty shot was awarded was such as to normally incur a minor penalty, then regardless of whether the penalty shot results in a goal or not, no further minor penalty shall be served.

If the offense for which the penalty shot was awarded was such as to incur a double minor penalty, or where the offending team is assessed an additional minor penalty on the same stoppage of play in which the penalty shot was awarded, the first minor penalty is not assessed since the penalty shot was awarded to restore the lost scoring opportunity. The second minor penalty would be assessed and served regardless of whether the penalty shot results in a goal or not. This will be announced as a double minor penalty for the appropriate foul and the player will serve two (2) minutes only.

- (i) If the foul upon which the penalty shot is based occurs during actual playing time, the penalty shot shall be awarded and taken immediately in the usual manner notwithstanding any delay occasioned by a slow whistle by the Referee to allow play to continue until the attacking side has lost possession of the puck to the defending side, which delay results in the expiration of the regular playing time in any period.

The time required for the taking of a penalty shot

shall not be included in the regular playing time or overtime.

- (j) If, after a player's stick has been ruled illegal, he attempts to take a penalty shot with a second stick that is also ruled illegal prior to taking the penalty shot, the opportunity to take the penalty shot shall be disallowed. The player shall be assessed one minor penalty for the first illegal stick.

Rule 31. Goalkeeper's Penalties

- (a) A goalkeeper shall not be sent to the penalty bench for an offense which incurs a minor penalty, but instead, the minor penalty shall be served by another member of his Team who was on the ice when the offense was committed. This player is to be designated by the Manager or Coach of the offending Team through the playing Captain and such substitute shall not be changed.

(NOTE) A penalized player may not serve a goalkeeper's penalty.

- (b) A goalkeeper shall not be sent to the penalty bench for an offense which incurs a major penalty, but instead, the major penalty shall be served by another member of his Team who was on the ice when the offense was committed. This player is to be designated by the Manager or Coach of the offending Team through the playing Captain and such substitute shall not be changed.
- (c) Should a goalkeeper incur three (3) major penalties in one game, in accordance with Rule 27(b) – Major Penalties, he shall be ruled off the ice for the balance of the playing time and his place shall be taken by a member of his own club, or by a regular substitute goalkeeper who is available. Such player will be allowed the goalkeeper's equipment. (Major penalty plus game misconduct penalty and automatic fine of twenty-five dollars (\$25).)
- (d) Should a goalkeeper on the ice incur a misconduct penalty, this penalty shall be served by another member of his Team who was on the ice when the offense was committed. This player is to be designated by the Manager or Coach of the offending Team through the Captain and, in addition, the goalkeeper shall be fined fifteen dollars (\$15).
- (e) Should a goalkeeper incur a game misconduct penalty, his place will then be taken by a member of his own club, or by a regular substitute goalkeeper who is available, and such player will be allowed the goalkeeper's full equipment. In addition, the goalkeeper shall be

fined twenty five dollars (\$25).

- (f) Should a goalkeeper incur a match penalty, his place will then be taken by a member of his own club, or by a substitute goalkeeper who is available, and such player will be allowed the goalkeeper's full equipment. However, any additional penalties as specifically called for by the individual rules covering match penalties will apply, and the offending Team shall be penalized accordingly. Such additional penalties will be served by other members of the Team on the ice when the offenses were committed. These players are to be designated by the Manager or Coach of the offending Team through the Captain. (See Rules 43 and 69.)
- (g) Should a goalkeeper incur a match penalty, the case shall be investigated promptly by the President who shall have full power to fine or suspend the penalized goalkeeper or any other players in the altercation.
- (h) A minor penalty shall be imposed on a goalkeeper who leaves the immediate vicinity of his crease during an altercation. In addition, he shall be subject to a fine of twenty-five dollars (\$25) and this incident shall be reported to the President for such further disciplinary action as may be required.

(NOTE) All penalties imposed on a goalkeeper, regardless of who serves the penalty or any substitution, shall be charged in the records against the goalkeeper.

- (i) If a goalkeeper participates in the play in any manner when he is beyond the center red line, a minor penalty shall be imposed upon him.
- (j) A goalkeeper shall not play the puck outside of the designated area behind the net. This area shall be defined by lines that begin six feet (6') from either goal post and extend diagonally to points twenty-eight feet (28') apart at the end boards. Should the goalkeeper play the puck outside of the designated area behind the goal line, a minor penalty for delay of game shall be imposed. The determining factor shall be the position of the puck. The minor penalty will not be assessed when a goalkeeper plays the puck while still in his goal crease.

NEW

Rule 32. Delayed Penalties

- (a) If a third player of any Team shall be penalized while two (2) players of the same Team are serving penalties, the penalty time of the third player shall not commence until the penalty time of one of the two players already penalized has elapsed. Nevertheless, the third

player penalized must at once proceed to the penalty bench but may be replaced by a substitute until such time as the penalty time of the penalized player shall commence.

- (b) When any Team shall have three (3) players serving penalties at the same time and because of the delayed penalty rule, a substitute for the third offender is on the ice, none of the three penalized players on the penalty bench may return to the ice until play has stopped. When play has been stopped, the player whose full penalty has expired may return to the play.

Provided however that the Penalty Timekeeper shall permit the return to the ice in the order of expiration of their penalties, of a player or players when, by reason of the expiration of their penalties, the penalized Team is entitled to have more than four (4) players on the ice.

- (c) In the case of delayed penalties, the Referee shall instruct the Penalty Timekeeper that penalized players whose penalties have expired shall only be allowed to return to the ice when there is a stoppage of play. When the penalties of two (2) players of the same Team will expire at the same time, the Captain of that Team will designate to the Referee which of such players will return to the ice first and the Referee will instruct the Penalty Timekeeper accordingly.

When a major and a minor penalty are imposed at the same time on players of the same Team, the Penalty Timekeeper shall record the minor as being the first of such penalties.

(NOTE) This applies to the case where the two penalties are imposed on DIFFERENT players of the same Team. See also Note to Rule 26 – Minor Penalties.

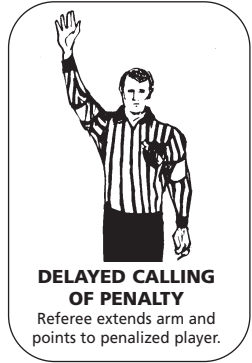

Rule 33. Calling of Penalties

- (a) Should an infraction of the rules which would call for a minor, major, misconduct, game misconduct or match penalty be committed by a player of the side in possession of the puck, the Referee shall immediately blow his whistle and penalize the offending player.

The resulting face-off shall be made at the place where the play was stopped for the assessment of the

penalty, unless the stoppage occurs in the attacking zone of the player penalized in which case the face-off shall be made at the nearest face-off spot in the neutral zone.

- (b) Should an infraction of the rules which would call for a minor, major, misconduct, game misconduct or match penalty be committed by a player of the Team not in possession of the puck, the Referee will raise his arm to signal the delayed calling of a penalty. When the Team to be penalized gains control of the puck, the referee will blow his whistle to stop play and impose the penalty on the offending player.

(NOTE) There shall be no signal given by the Referee for a misconduct or game misconduct penalty under this section.

The resulting face-off shall be located where the play was stopped when the offending Team gained control of the puck, except when they do so in their attacking zone, to which the ensuing face-off will be conducted in the neutral zone near the defending Team's blue line.

If the stoppage of play is caused by the defending Team (puck frozen along boards, frozen by goalkeeper, shot out of play) and the attacking Team is to be penalized, the resulting face-off shall be made at the place where the play was stopped. The only exception to this face-off location is if, prior to the stoppage of play for the assessment of the penalty, the non-offending Team ices the puck, then the face-off following the stoppage shall take place in the neutral zone near the defending blue line of the Team shooting the puck.

If the penalty to be imposed is a minor penalty and a goal is scored on the play by the non-offending side, the minor penalty shall not be imposed but major and match penalties shall be imposed in the normal manner regardless of whether or not a goal is scored.

Minor penalty expiration criteria:

- i) Is the Team scored against short-handed?
- ii) Is the Team scored against serving a minor penalty on the clock?

If both criteria are satisfied, the minor penalty with the least amount of time on the clock shall terminate except when coincidental penalties are being served.

(NOTE) No penalty shall expire when a goal is scored against a Team on a penalty shot (Rule 26(c)).

When the penalty to be imposed is applicable under Rule 46(a) – Butt-Ending; Rule 60(a) – Head-Butting; Rule 61(b)(1) – High Sticks or Rule 86(a) – Sparring, and a goal is scored, two (2) minutes of the appropriate

penalty will be assessed to the offending player. (This will be announced as a double minor for the appropriate foul and the player will serve two (2) minutes only.)

If when a Team is "short-handed" by reason of one or more minor or bench minor penalties, the Referee signals a further minor penalty or penalties against the "short-handed" Team and a goal is scored by the non-offending side before the whistle is blown, then the goal shall be allowed. The penalty or penalties signaled shall be assessed and the first of the minor penalties already being served shall automatically terminate under Rule 26(c) – Minor Penalties. Major and match penalties shall be imposed in the normal manner regardless of whether or not a goal is scored.

(NOTE 1) "Completion of the play by the Team in possession" in this Rule means that the puck must have come into the possession and control of an opposing player or has been "frozen". This does not mean a rebound off the goalkeeper, the goal or the boards, or any accidental contact with the body or equipment of an opposing player. "Control of the puck" means the act of propelling the puck with the stick, hand or feet. If while it is being propelled, the puck is touched by another player or his equipment, or hits the goal or goes free, the player shall no longer be considered to be "in control of the puck".

(NOTE 2) If after the Referee has signaled a penalty but before the whistle has been blown, the puck shall enter the goal of the non-offending Team as the direct result of a player of that Team, the goal shall be allowed and the penalty signaled shall be imposed in the normal manner. No goal may be scored by the offending team during the delayed calling of a penalty unless the non-offending team puts it directly into their own net. This shall mean that a deflection off an offending player or goalkeeper, or any physical action by an offending player that may cause the puck to enter the non-offending team's goal, shall not be considered a legal goal. Play shall be stopped before the puck enters the net (whenever possible), and the signaled penalty assessed to the offending team.

- (c) Should the same offending player commit other fouls on the same play, either before or after the Referee has blown his whistle, the offending player shall serve such penalties consecutively.

Rule 33A. Supplementary Discipline

In addition to the automatic fines and suspensions imposed under these Rules, the President may, at his discretion, investigate any incident that occurs in connection with any pre-season, exhibition, League or playoff game and may assess additional fines and/or suspensions for any offense committed during the course of a game or any aftermath thereof by a player, Trainer, Manager, Coach or club executive, whether or not such

offense has been penalized by the Referee.

(NOTE) If an investigation is requested by a Club or by the League on its own initiative, it must be initiated within twenty-four (24) hours following the completion of the game in which the incident occurred.

**Rule 33B. Suspensions Arising from
Pre-season and Exhibition Games**

Whenever suspensions are imposed as a result of infractions occurring during pre-season and exhibition games, the President shall exercise his discretion in scheduling the suspensions to ensure that no Team shall be short more players in any regular League game than it would have been had the infractions occurred in regular League games.

SECTION FIVE – OFFICIALS

Rule 34. Appointment of Officials

- (a) The President shall appoint a Referee and two Linesmen for each game, as well as Game Timekeeper, Penalty Timekeeper, Official Scorer and two Goal Judges for each game which will be determined through the home Team.
 - (b) The President shall forward to all clubs a list of Referees and Linesmen, all of whom must be treated with proper respect at all times during the season by all players and officials of clubs.
-

Rule 35. Referee

- (a) The Referee shall have general supervision of the game and shall have full control of all game officials and players during the game, including stoppages; and in case of any dispute, his decision shall be final.

(NOTE) As there is a human factor in involving in blowing the whistle to stop play, the Referee may deem the play to be stopped slightly prior to the whistle actually being blown. The fact that the puck may come loose or cross the goal line prior to the sound of the whistle has no bearing if the Referee has ruled that the play had been stopped prior to this happening.

The Referee shall remain on the ice at the conclusion of each period until all players have proceeded to their dressing rooms.

- (b) All Referees and Linesmen shall be dressed in black trousers and official sweaters.
They shall be equipped with approved whistles, tape measure and an official stick measuring gauge.
- (c) The Referee shall order the Teams on the ice at the appointed time for the beginning of a game and at the commencement of each period. If for any reason, there is more than fifteen (15) minutes' delay in the commencement of the game or any undue delay in resuming play after the eighteen (18) minute intervals between periods, the Referee shall state in his report to the President the cause of the delay and the club or clubs which were at fault.
- (d) It shall be his duty to see to it that all players are properly dressed, and that the approved regulation equipment (including the approved supplier pool program) is in use at all times during the game.
- (e) The Referee shall, before starting the game, see that the appointed Game Timekeeper, Penalty Timekeeper, Official Scorer and Goal Judges are in their respective places and ensure that the timing and signaling equip-

ment are in order.

- (f) It shall be his duty to impose such penalties as are prescribed by the rules for infractions thereof and he shall give the final decision in matters of disputed goals. The Referee may consult with the Linesmen or Goal Judge before making his decision.
- (g) The Referee shall announce have announced over the public address system information regarding the legality of an apparent goal. The Official Scorer will confirm the goal scorer and any players deserving of an assist. See also Rule 57 (Note) – Goals and Assists.

The Referee shall have announced over the public address system the reason for not allowing a goal every time the goal signal light is turned on in the course of play. This shall be done at the first stoppage of play regardless of any standard signal given by the Referee when the goal signal light was put on in error.

The Referee shall report to the Official Scorer the name or number of the goal scorer but he shall not give any information or advice with respect to the awarding of assists.

(NOTE) The name of the scorer and any player entitled to an assist will be announced over the public address system. In the event that the Referee disallows a goal for any violation of the rules, he shall report the reason for the disallowance to the Official Scorer who shall have announced the Referee's decision correctly over the public address system.

The infraction of the rules for which each penalty has been imposed will be announced correctly, as reported by the Referee, over the public address system. Where players of both Teams are penalized on the same play, the penalty to the visiting player will be announced first.

Where a penalty is imposed by the Referee which calls for a mandatory or automatic fine, only the time portion of the penalty will be reported by the Referee to the Official Scorer and announced over the public address system, and the fine will be collected through the League Office.

- (h) The Referee shall see to it that players of opposing Teams are separated on the penalty bench to prevent feuding.
- (i) The Referee shall not halt the game for any infractions of the rules concerning off-side play at the blue line or center line, or any violation of Rule 65, Icing the Puck. Determining infractions of these rules is the duty of the Linesmen unless, by virtue of some accident, the Linesman is prevented from doing so in which case the duties of the Linesman shall be assumed by the Referee

until play is stopped.

- (j) Should a Referee accidentally leave the ice or receive an injury which incapacitates him from discharging his duties while play is in progress, the game shall be automatically stopped.
- (k) If, through misadventure or sickness, the Referee and Linesmen appointed are prevented from appearing, the Managers or Coaches of the two clubs shall agree on a Referee and Linesman upon approval by the President. If they are unable to agree, they shall appoint a player from each side who shall act as Referee and Linesman; the player of the home club acting as Referee and the player of the visiting club as Linesman.
- (l) If the regularly appointed Officials appear during the progress of the game, they shall at once replace the temporary Officials.
- (m) Should a Linesman appointed be unable to act at the last minute or through sickness or accident be unable to finish the game, the Referee shall have the power to appoint another in his stead, if he deems it necessary, or if required to do so by the Manager or Coach of either of the competing Teams.
- (n) If, owing to illness or accident, the Referee is unable to continue to officiate, one of the Linesmen shall perform the duties of the ill or injured Referee during the balance of the game. If a Linesman is to be assigned, the Referee or Officiating Supervisor will select him. In the event that a CHL Supervisor is in attendance at a game where a spare Official is present, he shall have the authority to substitute the injured Referee with the spare Official.
- (o) The Referee shall check club rosters and all players in uniform before signing the Official Report of Match form.
- (p) The Referee shall report to President promptly and in detail the circumstances of any of the following incidents:
 - (i) When a stick or part thereof is thrown outside the playing area – Rule 88(c) – Throwing Stick;
 - (ii) Every obscene gesture made by any person involved in the playing or conduct of the game whether as a participant or as an official of either Team or of the League, which gesture he has personally observed or which has been brought to his attention by any game official – Rule 73(a) – Obscene Language or Gestures;
 - (iii) When any player, Trainer, Coach or club executive becomes involved in an altercation with a spectator – Rule 68(b) – Interference by/with Spectators;

- (iv) Every infraction under Rule 27(b) – Major Penalties, whenever a major penalty and game misconduct is assessed.
- (v) Anytime a player is deemed the instigator of the aggressor in a fight – Rule 56(a) – Fisticuffs.
- (q) In the event of failure by a club to comply with a provision of the League constitution, by-laws, resolutions, rules or regulations affecting the playing of a game, the Referee shall, if so directed by the President or his designee, refuse to permit the game to proceed until the offending club comes into compliance with such provision.

Should the offending club persist in its refusal to come into compliance, the Referee shall, with the prior approval of the President or his designee, declare the game forfeited and the non-offending club the winner. Should the Referee declare the game forfeited because both clubs have refused to comply with such a provision, the visiting club shall be declared the winner.

If the game is declared forfeited prior to its having commenced, the score shall be recorded as 1-0 and no player shall be credited with any personal statistics.

If the game was in progress at the time it is declared forfeited, the score shall be recorded as zero for the loser and 1, or such greater number of goals that had been scored by it, for the winner; however, the players on both clubs shall be credited with all personal statistics earned up to the time the forfeit was declared.

- (r) In the event of any dispute regarding time or the expiration of penalties, the matter shall be referred to the Referee for adjudication and his decision shall be final.

Rule 36. Linesmen

- (a) The Linesman shall stop play:
 1. When premature substitution of the goalkeeper has occurred: Rule 17(a) – Change of Players.
 2. When he deems that a player has sustained a serious injury: Rule 18(f) – Injured Players.
 3. When the goal post has been displaced from its normal position: Rule 51 – Delaying the Game.
 4. For premature entry into the face-off area: Rule 54(a)(e) – Face-offs.
 5. When the puck has been directed with a hand to a teammate in any zone other than the defensive zone: Rule 59(e) – Handling the Puck with Hands.
 6. When the puck is struck by a stick above the height of the shoulders: Rule 61(d) – High Sticks.
 7. When either Team ices the puck: Rule 65 – Icing

the Puck.

8. When there has been interference by/with spectators: Rule 68 – Interference by/with Spectators.
 9. For any infraction of the rules concerning off-side at the blue line: Rule 74 – Off-Side, and Rule 77 – Preceding Puck into the Attacking Zone.
 10. When the puck is out of bounds or unplayable: Rule 80 – Puck Out of Bounds or Unplayable.
 11. When a goal has been scored that has not been observed by the Referee.
 12. When the puck is interfered with by an ineligible player/person.
 13. The calling of a penalty shot under Rule 88(a) – Throwing Stick.
- (b) The Linesman may stop play and assess a minor penalty for:
1. There are too many men on the ice: Rule 17 – Change of Players.
 2. Articles are thrown on the ice from the players' bench or penalty bench: Rule 41(k) – Abuse of Officials and Other Misconduct.
 3. When Team personnel interfere with a game official: Rule 41(l) – Abuse of Officials and Other Misconduct.
 4. When a player who has lost or broken his stick receives one illegally: Rule 45(c) – Broken Stick.
 5. Delay of game by deliberately displacing goal post: Rule 51(c) – Delaying the Game.
 6. The instigation of an incident by a player of the opposing Team for which a major/match penalty was assessed following the original incident. The Linesman will report this to the Referee.
- (c) The Linesman may stop play and assess a double minor for:
1. Butt-Ending: Rule 46(a) – Butt-Ending.
 2. Head-Butting: Rule 60(a) – Head-Butting.
 3. High-Sticking: Rule 61(b) – High Sticks.
 4. Spearing: Rule 86(a) – Spearing.
- The Linesman may stop play and impose any major penalty when a serious incident has occurred.
- (d) The Linesman must report upon completion of play, any circumstances pertaining to:
1. Match penalties: Rule 43 – Attempt to or Deliberate Injury of Opponents.
 2. Bench minor penalties (Unsportsmanlike Conduct): Rule 41(a) – Abuse of Officials.
 3. Misconducts, Game Misconducts and Gross Misconducts: Rule 28 – Misconduct Penalties.
 4. Interference with a goalkeeper when a goal has been scored.

- (e) The Linesman shall face-off the puck at all times except to start the game.
 - (f) The Linesman shall give to the Referee his interpretation of any incident that may have taken place during the game.
-

Rule 37. Goal Judge

- (a) There shall be one (1) Goal Judge situated behind each goal. They shall not be replaced during the game unless due to sickness or some other unforeseen circumstance.
 - (b) Goal Judges shall be stationed behind the goals during the progress of play, in properly protected areas, if possible, so that there can be no interference with their activities. They shall not change goals during the game.
 - (c) In the event of a goal being claimed, the Goal Judge of that goal shall decide whether or not the puck has passed between the goal posts and entirely over the goal line.
-

Rule 38. Penalty Timekeeper

- (a) The Penalty Timekeeper shall keep, on the official forms provided, a correct record of all penalties imposed by the Officials including the names of the players penalized, the penalties assessed, the duration of each penalty and the time at which each penalty was imposed. He shall report on the Penalty Record form each penalty shot awarded, the name of the player taking the penalty shot and the result of the shot. He shall also record on the Penalty Record form the details and the result of any stick measurement performed by the Referee during the game.
- (b) The Penalty Timekeeper shall check to ensure that the time served by all penalized players is correct. The Penalty Timekeeper shall be responsible for the correct posting of penalties on the scoreboard at all times and shall promptly call to the attention of the Referee any discrepancy between the time recorded on the clock and the official correct time and shall be responsible for making any adjustments ordered by the Referee.

The Penalty Timekeeper shall upon request, give a penalized player correct information as to the unexpired time of his penalty.

(NOTE 1) The infraction of the rules for which each penalty has been imposed will be announced twice over the public address system as reported by the Referee. Where players of both Teams are penalized at the same time, the penalty to the visiting player will be announced first.

(NOTE 2) Misconduct penalties and coincident major penalties should not be recorded on the timing device (penalty time clock) but such penalized players should be alerted and released at the first stoppage of play following the expiration of their penalties.

- (c) Upon the completion of each game, the Penalty Timekeeper shall complete and sign the Penalty Record and shall have the Referee sign the official game sheet before inputting the game as final. The approved form is to be distributed as quickly as possible to the following persons:
 - (1) One copy to the Official Scorer for transmission to the League President;
 - (2) One copy to the visiting Coach or Manager;
 - (3) One copy to the home Coach or Manager;
 - (4) One copy to the home Team Public Relations Department.
- (d) The Hockey Operations/Officiating Department shall be entitled to inspect, collect and forward to the League Office the actual work sheets used by the Penalty Timekeeper in any game.
- (e) The Penalty Timekeeper shall have an official stick measuring gauge and tape measure available for the Officials' use during the game.

Rule 39. Official Scorer

- (a) Before the start of the game, the Official Scorer shall obtain from the Manager or Coach of both Teams a list of all eligible players and the starting line-up of each Team which information shall be made known to the opposing Manager or Coach before the start of play.

The Official Scorer shall secure the names of the Captain and Alternate Captains from the Manager or Coach at the time the line-ups are collected and will indicate those nominated by placing the letter "C" or "A" opposite their names on the Official Report of Match form. All of this information shall be presented to the Referee for his signature at the completion of the game.
- (b) The Official Scorer shall keep a record of the goals scored, the scorers, and players to whom assists have been credited and shall indicate those players on the lists who have actually taken part in the game. He shall also record the time of entry into the game of any substitute goalkeeper. He shall record on the Official Score Sheet a notation where a goal is scored when the goalkeeper has been removed from the ice.
- (c) The Official Scorer shall award the points for goals and assists and his decision shall be final. The awards of points for goals and assists shall be announced twice

over the public address system and all changes in such awards shall also be announced in the same manner.

No requests for changes in any award of points shall be considered unless they are made at or before the conclusion of actual play in the game by the Team Captain, or immediately following the game by a Team representative.

- (d) At the conclusion of the game, the Official Scorer shall complete and sign the Official Score Sheet and shall have the Referee sign the official game sheet before inputting the game as final. The approved form is to be distributed as quickly as possible to the following persons:
 - (1) One copy to the Official Scorer to be transmitted to the League President;
 - (2) One copy to the visiting Coach or Manager;
 - (3) One copy to the home Coach or Manager;
 - (4) One copy to the home Team Public Relations Department.
- (e) The Official Scorer shall prepare the Official Report of Match form for signature by the Referee and forward it to the League Office electronically together with the Score Sheet and the Penalty Record forms.
- (f) The Official Scorer should view the game from an elevated position, well away from the players' benches, with house telephone communication to the public address announcer.

Rule 40. Game Timekeeper

- (a) The Game Timekeeper shall record the time of starting and finishing of each period in the game. During the game the Game Timekeeper will start the clock with the drop of the puck and stop the clock upon hearing the Officials' whistle or the scoring of a goal. Any loss of time on the game or penalty clocks due to a false face-off must be replaced as deemed appropriate.
- (b) The Game Timekeeper shall signal the Referee and the competing Teams for the start of the game and each succeeding period and the Referee shall start the play promptly in accordance with Rule 90 – Time of Match.

For the purpose of keeping the spectators informed as to the time remaining during intermissions, the Game Timekeeper will use the electric clock to record the length of intermissions. The clock will not start for the intermission until all players and Officials have left the ice.

To assist in assuring the prompt return to the ice of the Teams and the Officials, the Game Timekeeper shall

- give preliminary warnings of five (5) minutes and two (2) minutes prior to the resumption of play in each period.
- (c) If the arena is not equipped with an automatic signaling device or, if such device fails to function, the Game Timekeeper shall signal the end of each period by blowing a whistle.
 - (d) The Game Timekeeper shall cause to be announced over the public address system at the nineteenth minute in each period that there is one (1) minute remaining to be played in the period.
 - (e) In the event of any dispute regarding time, the matter shall be referred to the Referee for adjudication and his decision shall be final. The Game Timekeeper shall assist to verify game time using an additional timing device. (CHL approved stopwatch.)
 - (f) The Game Timekeeper is required to synchronize his timing device with the Television Producer of the originating broadcast if the game is televised.
-

Rule 40A. Statistician

- (a) There shall be appointed for duty at every game played in the League a Statistician and such assistants or alternates as may be deemed necessary.
- (b) The duty of the Statistician(s) is to correctly record on official League forms all of the required data concerning the performances of the individual players and Teams.
- (c) These records shall be compiled and recorded in strict conformity with the instructions printed on the forms supplied and shall be completed as to totals where required and with such accuracy as to ensure that the data supplied is "in balance".
- (d) At the conclusion of each game, the Statistician shall sign and shall have the Referee sign the official game sheet before inputting the game as final. The approved form is to be distributed as quickly as possible to the following persons:
 - (1) One copy to the Official Scorer for transmission to the League President;
 - (2) One copy to the visiting Coach or Manager;
 - (3) One copy to the home Coach or Manager;
 - (4) One copy to the home Team Public Relations Department.

SECTION SIX – PLAYING RULES

**Rule 41. Abuse of Officials
and other Misconduct**

- (a) A minor penalty for unsportsmanlike conduct shall be imposed on any player who uses obscene, profane or abusive language to any person. If this conduct persists, he shall be assessed a misconduct penalty and if this conduct further persists, then a game misconduct penalty shall be imposed. A misconduct penalty shall be imposed on any player who intentionally knocks or shoots the puck out of the net and/or out of reach of an Official who is retrieving it or who deliberately throws any equipment out of the playing area.
- (b) A minor penalty for unsportsmanlike conduct shall be assessed to any player who challenges or disputes the rulings of any Official during a game. If the player persists in such challenge or dispute, he shall be assessed a misconduct penalty and any further dispute will result in a game misconduct penalty being assessed to the offending player.

**UNSPORTSMANLIKE
CONDUCT**

Use both hands to form a
"T" in front of the chest.

(NOTE) Any player who, having entered the penalty bench, leaves the penalty bench prior to the expiration of his penalty for the purpose of challenging an Official's ruling, shall be assessed a game misconduct penalty. He shall also be automatically suspended for the next two (2) regular League and/or playoff games of his club. This Rule does not replace any other more severe penalty that may be imposed for leaving the penalty bench for the purpose of starting or participating in an altercation. See Rule 72 – Leaving Players' or Penalty Bench.

- (c) A minor penalty for unsportsmanlike conduct shall be assessed to any player or players who bang the boards with their sticks or other objects at any time, or who, in any manner, shows disrespect for an Official's decision. If this conduct persists, he shall be assessed a misconduct penalty and if this conduct further persists, then a game misconduct shall be imposed.

In the event that the Coach, Trainer, Manager or club executive commits an infraction under this Rule, a bench minor penalty shall be imposed.

- (d) Where coincident penalties are imposed on players of

both Teams, the penalized players of the visiting Team shall take their positions on the penalty bench first in the place designated for visiting players.

- (e) Any player who, following a fight or other altercation in which he has been involved is broken up and for which he is penalized, fails to proceed directly and immediately to the penalty bench, or who causes any delay by retrieving his equipment (gloves, sticks, etc. shall be delivered to him at the penalty bench by Teammates), shall incur an automatic fine of fifteen dollars (\$15) in addition to all other penalties or fines incurred.
- (f) Any player who persists in continuing or attempting to continue a fight or altercation after he has been ordered by the Referee to stop, or who resists a Linesman in the discharge of his duties shall, at the discretion of the Referee, incur a misconduct or game misconduct penalty in addition to any penalties imposed. (See also Rule 76 – Physical Abuse of Officials.)
- (g) A misconduct penalty shall be imposed on any player who persists in any course of conduct (including threatening or abusive language or gestures or similar actions) designed to incite an opponent into incurring a penalty.

If, after the assessment of a misconduct penalty, a player persists in any course of conduct for which he was previously assessed a misconduct penalty, he shall be assessed a game misconduct penalty.

- (h) A bench minor penalty shall be imposed against the offending Team if any player, club executive, Manager, Coach or Trainer uses obscene, profane or abusive language or gesture to any person or uses the name of any Official coupled with any vociferous remarks.

A gross misconduct penalty shall be assessed to any player or non-playing club personnel who directs obscene, profane or abusive language or gestures to any person or uses the name of any Official coupled with any vociferous remarks, after the expiration of the game. This action may occur on or off the ice.

This shall also apply to anyone who throws or shoots any equipment or other object in the general direction of an Official but does not come close to making any kind of contact. This action may occur on or off the ice.

Any player or non-playing club personnel penalized under this section may be subject to supplemental discipline under Rule 33A.

- (i) In the case of any club executive, Manager, Coach or Trainer being guilty of such misconduct, he is to be removed from the bench by order of the Referee and his case reported to the President for further action. (Refer to Rule 73(c) – Obscene Language or Gestures.)
- (j) If any club executive, Manager, Coach or Trainer is removed from the bench by order of the Referee, he must not sit near the bench of his club nor in any way direct or attempt to direct the play of his club.

When a Coach has been removed from the bench, he shall be assessed a game misconduct penalty. Following the game, a detailed report must be filed with the President.

- (k) A bench minor penalty shall be imposed against the offending Team if any player, Trainer, Coach, Manager or club executive in the vicinity of the players' bench or penalty bench throws anything on the ice during the progress of the game or during stoppage of play.
- (l) A bench minor penalty shall be imposed against the offending Team if any player, Trainer, Coach, Manager or club executive interferes in any manner with any game official including the Referee, Linesmen, Timekeepers or Goal Judges in the performance of their duties.

The Referee may assess further penalties under Rule 76 – Physical Abuse of Officials if he deems them to be warranted.

- (m) A misconduct penalty shall be imposed on any player or players who, except for the purpose of taking their positions on the penalty bench, enter or remain in the Referee's crease while he is reporting to or consulting with any game official including Linesmen, Timekeeper, Penalty Timekeeper, Official Scorer or Announcer.
- (n) A minor penalty shall be imposed on any player who is guilty of unsportsmanlike conduct including, but not limited to hair-pulling, biting, grabbing hold of a face mask, etc.

(NOTE) In severe cases of hair pulling, biting or grabbing hold of a face mask, and specifically when injury results, Rule 43 – Attempt to or Deliberate Injury of Opponents must be applied and a match penalty assessed.

Rule 42. Adjustment to Clothing or Equipment

- (a) Play shall not be stopped nor the game delayed by reasons of adjustments to clothing, equipment, skates or sticks.

For an infringement of this Rule, a minor penalty shall be given.

- (b) The onus of maintaining clothing and equipment in proper condition shall be upon the player. If adjustments are required, the player shall leave the ice and play shall continue with a substitute.
- (c) No delay shall be permitted for the repair or adjustment of goalkeeper's equipment. If adjustments are required, the goalkeeper shall leave the ice and his/her place shall be taken by the substitute goalkeeper immediately.
- (d) For an infraction of this Rule by a goalkeeper, a minor penalty shall be imposed.

Rule 43. Attempt to or Deliberate Injury of Opponents

- (a) A match penalty shall be imposed on any player who deliberately attempts or who deliberately injures an opponent and the circumstances shall be reported to the President for further action.

A match penalty can be assessed for the following infractions:

- i) attempt to injure in any manner* (Rule 43)
- ii) biting (Rule 41)
- iii) butt-ending* (Rule 46)
- iv) cross-checking (Rule 50)
- v) deliberate injury in any manner* (Rule 43)
- vi) hair pulling (Rule 41)
- vii) head-butting* (Rule 60)
- viii) high sticking (Rule 61)
- ix) kicking a player (Rule 69)
- x) kneeling (Rule 71)
- xi) slashing (Rule 85)
- xii) slew-footing (Rule 91)
- xiii) spearing* (Rule 86)
- xiv) throwing stick or any object (Rule 88)
- xv) wearing tape or other material on hands in an altercation* (Rule 56)
- xvi) goalkeeper who uses his blocking glove to the head or face of an opponent* (Rule 84)

(* = match penalty MUST be assessed when injury results).

- (b) In addition to the match penalty, the player shall be automatically suspended from further competition until the President has ruled on the issue.
- (c) No substitute shall be permitted to take the place of the penalized player until five (5) minutes of actual playing time have elapsed from the time the penalty was imposed.

- (d) A game misconduct penalty shall be imposed on any player who deliberately attempts to injure an Official, Manager, Coach or Trainer in any manner and the circumstances shall be reported to the President for further action. (See also Rule 76 – Physical Abuse of Officials.)
-

Rule 44. Board Checking

- (a) A minor or major penalty, at the discretion of the Referee, based upon the degree of violence of the impact with the boards, shall be imposed on any player who checks an opponent in such a manner that causes the opponent to be thrown violently in the boards.

(NOTE) Any unnecessary contact with a player playing the puck on an obvious "icing" or "off-side" play which results in that player being knocked into the boards is "boarding"

and must be penalized as such. In other instances where there is no contact with the boards, it should be treated as "charging".

- (b) When a major penalty is imposed under this Rule for a foul resulting in an injury to the face or head of an opponent, a game misconduct shall be imposed, along with an automatic fine of twenty-five dollars (\$25).
- (c) Any player who incurs a total of two (2) game misconducts for Boarding under Rule 44(b), in either Regular Season or Playoffs, shall be suspended automatically for the next game of his Team. For each subsequent game misconduct penalty the automatic suspension shall be increased by one (1) game.
-

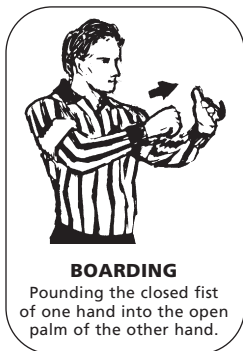

BOARDING

Pounding the closed fist of one hand into the open palm of the other hand.

Rule 45. Broken Stick

(NOTE) A broken stick is one which, in the opinion of the Referee, is unfit for normal play.

- (a) A player without a stick may participate in the game. A player whose stick is broken may participate in the game provided he drops the broken stick. A minor penalty shall be imposed for an infraction of this Rule.
- (b) A goalkeeper may continue to play with a broken stick until a stoppage of play or until he has one legally handed to him by a teammate.
- (c) A player who has lost or broken his stick may only receive a stick at his own players' bench or be handed

NEW

one from a Teammate on the ice. A minor penalty shall be imposed for an infraction of this Rule.

(NOTE) A player tendered a stick thrown on the ice from the players' or penalty bench will not receive a penalty. However, the person responsible for throwing the stick will receive the penalty, as covered in Rule 41(k) – Abuse of Officials and Other Misconduct and Rule 67(g)(h)(i) – Interference.

- (d) A goalkeeper whose stick is broken or illegal may not go to the players' bench for a replacement but must receive his stick from a Teammate. For an infraction of this Rule, a minor penalty shall be imposed on the goalkeeper.

Rule 46. Butt-Ending

(NOTE) Butt-ending shall mean using the end of the shaft of the stick in a jabbing motion.

- (a) A double-minor penalty will be imposed on a player who attempts to butt-end an opponent.
 (b) A major penalty and a game misconduct shall be imposed on a player who butt-ends an opponent.

In addition to the major penalty and game misconduct imposed under this Rule, an automatic fine of twenty-five dollars (\$25) will be imposed.

- (c) A match penalty shall be imposed on a player who injures an opponent as a result of a butt-end. See Rule 43 – Attempt to or Deliberate Injury of Opponents.

Rule 47. Charging

Charging shall mean the actions of a player who, as a result of distance traveled, shall violently check an opponent in any manner. A "Charge" may be the result of a check into the boards, into the goal frame or in open ice.

- (a) A minor or major penalty shall be imposed on a player who skates or jumps into, or charges an opponent in any manner.
 (b) When a major penalty is imposed under this Rule for a foul resulting in an injury to the face or head of an opponent, a game misconduct shall be imposed, and an automatic fine of twenty-five dollars (\$25).
 (c) A minor, major or a major and a game misconduct shall be imposed on a player who charges a goalkeeper



CHARGING

Rotating clenched fists around one another in front of chest.

while the goalkeeper is within his goal crease.

(NOTE) A goalkeeper is NOT "fair game" just because he is outside the goal crease area. The appropriate penalty should be assessed in every case where an opposing player makes unnecessary contact with a goalkeeper. However, incidental contact, as the discretion of the Referee, will be permitted when the goalkeeper is in the act of playing the puck outside his goal crease provided the attacking player has made a reasonable effort to avoid such contact.

Although goalkeepers are provided with additional protection under Rule 78 – Protection of the Goalkeeper, they are still subject to penalties for infractions of the rules that they commit in or out of the goal crease. Particular attention will be made by the Referees to goalkeepers that embellish the contact in an attempt to draw a penalty.

Rule 48. Checking from Behind

A check from behind is a check delivered on a player who is not aware of the impending hit, therefore UNABLE TO DEFEND HIMSELF, and contact is made on the back part of the body. When a player intentionally turns his body to create contact with his back, no penalty shall be assessed.

- (a) Any player who cross-checks, pushes or charges from behind an opponent who is unable to defend himself, shall be assessed a major and a game misconduct. This penalty applies anywhere on the playing surface.
 - (b) Any player who incurs a total of two (2) game misconducts for Checking from Behind under Rule 48(a) in either Regular Season or Playoffs, shall be suspended automatically for the next game of his Team. For each subsequent game misconduct penalty the automatic suspension shall be increased by one (1) game.
-

Rule 49. Clipping

Clipping is the act of throwing the body, from any direction, across or below the knees of an opponent.

- (a) A player may not deliver a check in a "clipping" manner, nor lower his own body position to deliver a check on or below an opponent's knees.
- (b) An illegal "low hit" is a check that is delivered by a player who may or may not have both skates on the ice, with his sole intent to check the opponent in the area of his knees. A player may not lower his body position to deliver a check to an opponent's knees.

A player who commits these fouls will be assessed a minor penalty for "clipping". If an injury occurs as a result of this "clipping" check, the player must be assessed a major penalty and a game misconduct.

Rule 50. Cross-Checking

(NOTE) A cross-check shall mean a check rendered with both hands on the stick, and the extending of the arms, while the check is being delivered.

- (a) A minor or major penalty, at the discretion of the Referee, shall be imposed on a player who "cross-checks" an opponent.

When a major penalty is assessed for cross-checking, an automatic game misconduct penalty shall be imposed on the offending player.

- (b) When a major penalty is imposed under this Rule, an automatic fine of twenty-five dollars (\$25) shall also be imposed.



CROSS-CHECKING

A forward and backward motion with both fists clenched extending from the chest.

Rule 51. Delaying the Game

- (a) A minor penalty shall be imposed on any player or goalkeeper who delays the game by deliberately shooting or batting the puck with his stick outside the playing area.

(NOTE 1) When the goalkeeper shoots the puck directly (non-deflected) out of the playing surface, except where there is no glass, a penalty shall be assessed for delaying the game. When the puck is shot by the goalkeeper into the players' bench, the penalty will not apply. When the puck is shot by the goalkeeper over the glass 'behind' the players' bench, the penalty will be assessed.

(NOTE 2) This penalty shall also apply when a player or goalkeeper deliberately bats or shoots the puck with his stick outside the playing area after a stoppage of play.

- (b) A minor penalty shall be imposed on any player or goalkeeper who throws or deliberately bats the puck with his hand or stick outside the playing area.
- (c) A minor penalty shall be imposed on any player (including the goalkeeper) who delays the game by deliberately displacing a goal post from its normal position. The Referee or Linesmen shall stop play immediately when the offending Team gains possession of the puck.

If the goal post is deliberately displaced by a goalkeeper or player during the course of a "breakaway", a penalty shot will be awarded to the non-offending Team, which shot shall be taken by the player last in possession of the puck.

(NOTE) A player with a "breakaway" is defined as a player in control of the puck with no opposition between him and the opposing goal and with a reasonable scoring opportunity.

In the event that a goalpost is deliberately displaced by a defending player or goalkeeper, a minor penalty shall be assessed for delaying the game. In the event that a goal post is deliberately displaced by a defending player, prior to the puck crossing the goal line between the normal position of the goalposts, the Referee may award a goal.

In order to award a goal in this situation, the goal post must have been deliberately displaced by a defending player, the puck must have been shot (or the player must be in the act of shooting) at the goal prior to the goal post being displaced, and it must be determined that the puck would have entered the net between the normal position of the goal posts. See also Rule 57 – Goals and Assists.

- (d) If by reason of insufficient time in the regular playing time or by reason of penalties already imposed, the minor penalty assessed to a player for deliberately displacing his own goal post cannot be served in its entirety within the regular playing time of the game or at any time in overtime, a penalty shot shall be awarded against the offending Team.
- (e) A bench minor penalty shall be imposed upon any Team which, after warning by the Referee to its Captain or Alternate Captain to place the correct number of players on the ice and commence play, fails to comply with the Referee's direction and thereby causes any delay by making additional substitutions, by persisting in having its players off-side, or in any other manner.

Rule 52. Diving

NEW

A minor penalty shall be imposed on a player who, in the opinion of the Referee, blatantly embellishes a fall, a reaction or feigns an injury in an attempt to draw a penalty by his actions. This penalty shall be assessed for Diving.

(NOTE) A player may also be penalized under this section if he intentionally skates into an opponent (when both he and his opponent are not in possession of the puck) in a clear attempt to draw a penalty on his opponent for a restraining foul.

Rule 53. Elbowing

Elbowing shall mean the use of an extended elbow in a manner that may or may not cause injury.

- (a) A minor or major penalty, at the discretion of the Referee, shall be imposed on any player who uses his elbow to foul an opponent.
- (b) When a major penalty is imposed under this Rule for a foul resulting in an injury to the face or head of an opponent, a game misconduct shall be imposed and an automatic fine of twenty-five dollars (\$25).

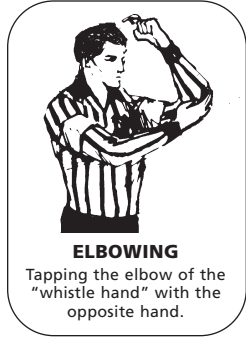

Rule 54. Face-Offs

- (a) Conduct of any face-off commences when the Official designates the place of the face-off and he takes up his position to drop the puck. As soon as the line change procedure has been completed by the Referee and he lowers his hand to indicate no further changes, the Linesman conducting the face-off shall blow his whistle. This will signal to both Teams that they have no more than five (5) seconds to line up for the ensuing face-off. At the end of the five (5) seconds (or sooner if both centers are ready), the Linesman will conduct a proper face-off. If, however:
 - (1) One or both centers are not positioned for the face-off,
 - (2) One or both centers refrain from placing their stick on the ice,
 - (3) Any player has encroached into the face-off circle,
 - (4) Any player makes physical contact with an opponent, or
 - (5) Any player is in an off-side position, the Linesman shall have the offending center(s) replaced immediately prior to dropping the puck.

If a center is not at the designated face-off area once the five (5) second time limit has elapsed, the Linesman will drop the puck immediately. If the center is back from the face-off dot, is "quarterbacking" or refuses to come into the face-off area when instructed to do so by the linesman, or the center is simply slow getting to the face-off dot when the five (5) seconds has elapsed, the

puck shall be dropped. If, the center attempts to arrive at the face-off dot just as the five seconds elapses in an attempt to gain an advantage to win the face-off, he is to be removed from the face-off and replaced, resulting in a face-off violation.

In the last two (2) minutes of regulation time or any-time in overtime, the linesman will still blow his whistle to initiate the face-off, but the five (5) second time limit will not be enforced, however, players must abide by the verbal directions given by the Linesman in his attempt to conduct a fast and fair face-off.

- (b) The puck shall be faced-off by the Referee or the Linesman dropping the puck on the ice between the sticks of the players facing-off. Players facing-off will stand squarely facing their opponent's end of the rink approximately one stick length apart with the blade of their sticks on the ice.

When the face-off takes place in any of the end zone face-off circles, the players taking part shall take their position so that they will stand squarely facing their opponent's end of the rink, and clear of the ice markings. The sticks of both players facing-off shall have the blade on the ice, within the designated white area. The visiting player shall place his stick within the designated white area first followed IMMEDIATELY by the home player.

No other player shall be allowed to enter the face-off circle or come within fifteen feet (15') of the players facing-off. All players must stand on-side on all face-offs. Players on the attacking team (exclusive of the center) must establish their position first and then the defending team may counter and hold their position until the puck is dropped. A violation of this procedure shall be treated as face-off encroachment and the Linesman shall order the center of the offending team replaced.

If a violation of this sub-section occurs, the Referee or Linesman shall conduct the face-off again.

- (c) In the conduct of any face-off anywhere on the playing surface, no player facing-off shall make any physical contact with his opponent's body by means of his own body or by his stick except in the course of playing the puck after the face-off has been completed.

For violation of this Rule, the Referee may, at his discretion, impose a minor penalty or penalties on the player(s) whose action(s) caused the physical contact. Nonetheless, this physical contact prior to the dropping of the puck shall be deemed a face-off violation and the

Linesman shall order the center of the offending team replaced.

Face-off encroachment may be applied during face-offs anywhere on the playing surface. However, since no such lines are painted on the ice, Linesmen shall use their judgment as to whether or not a violation has occurred. All players other than the centers shall be uniformly back from the face-off location similar to being outside the face-off circle for face-offs in the end zones.

- (d) If a player facing-off fails to take his proper position immediately when directed by the Official, the Official may order him replaced for that face-off by any teammate then on the ice. If a player is ejected from the face-off, his replacement must come into the position quickly or risk having the puck dropped by the Linesman without him being set, or ejected from the face-off by the Linesman resulting in a bench minor penalty for delay of game for a second face-off violation during the same face-off.

If the replacement center is back from the face-off dot, is "quarterbacking" or refuses to come into the face-off area when instructed to do so by the linesman, or the center is simply slow getting to the face-off dot when the five (5) seconds has elapsed, the puck shall be dropped. If, the center attempts to arrive at the face-off dot just as the five seconds elapses in an attempt to gain an advantage to win the face-off, he is to be removed from the face-off and replaced, resulting in a face-off violation.

No substitution of players shall be permitted until the face-off has been completed and play has resumed except when a penalty is imposed which affects the on-ice strength of either Team.

- (e) A second violation of any of the provisions of sub-section (a) hereof by the same Team during the same face-off shall be penalized with a bench minor penalty for delay of game to the offending Team. This penalty shall be announced as a "Bench Minor Penalty for Delay of Game – Face-Off Violation". Any loss of time on the game or penalty clocks due to a false face-off must be replaced.

During end zone face-offs, all other players on the ice must position their bodies on their own side of the restraining lines marked on the outer edge of the face-off circles.

If a player other than the player taking the face-off moves into the face-off circle prior to the dropping of

the puck, then the offending Team's player taking the face-off shall be ejected from the face-off circle.

Face-off violations shall be summarized as follows (any of the three on-ice Officials may identify a face-off violation):

- (1) Encroachment by any player other than the center into the face-off area prior to the puck being dropped.

(NOTE) Players on the perimeter of the face-off circle must keep both skates outside the face-off circle (skate contact with the line is permitted). If a player's skate crosses the line into the face-off circle prior to the drop of the puck, this shall be deemed as a face-off violation. A player's stick may be inside the face-off circle provided there is no physical contact with his opponent or his opponent's stick.

- (2) Encroachment by any player into the area between the hash marks on the outer edges of the face-off circle prior to the puck being dropped.

(NOTE) Players must also ensure that both of their skates do not cross their respective hash marks. Contact with the line with their skate is permitted. If a player's skate crosses the line into the area between the hash marks prior to the drop of the puck, this shall be deemed as a face-off violation. A player's stick may be inside the area between the hash marks provided there is no physical contact with his opponent or his opponent's stick.

- (3) Any physical contact with an opponent prior to the puck being dropped.
- (4) Failure by either center taking the face-off to properly position himself behind the restraining lines or place his stick on the ice (as outlined in Rule 54(b)).

(NOTE) "Properly position himself behind the restraining lines" shall mean that the center must place his feet on either side of the restraining lines that are parallel to the side boards (contact with the lines is permitted), and the toe of the blade of his skates must not cross over the restraining lines that are perpendicular to the side boards as he approaches the face-off spot.

The blade of the stick must then be placed on the ice (at least the toe of the blade of the stick) in the designated white area of the face-off spot and must remain there until the puck is dropped.

Failure to comply with this positioning and face-off procedure will result in a face-off violation.

Whenever a team has committed two face-off violations during the same face-off, the Referee shall immediately assess the offending Team a bench minor penalty for delay of game. This penalty shall be announced as a "Bench Minor Penalty for Delay of Game – Face-Off Violation".

Players who are in an off-side position for the ensuing face-off will be warned once in the game by the Referee. This warning will also be given to the offending team's Coach. Any subsequent violation shall result in a bench minor penalty for delay of game being assessed to the offending team. This penalty shall be announced as a "Bench Minor Penalty for Delay of Game – Slow Proceeding to Face-Off Location".

- (f) When an infringement of a rule has been committed or a stoppage of play has been caused by any player of the attacking side in the attacking zone, the ensuing face-off shall be made in the neutral zone on the nearest face-off spot.

If an attacking player is to be penalized, and the play is stopped due to the actions of a defending player (ie. puck frozen by the goalkeeper) the ensuing face-off will remain in the defending zone of the non-offending Team.

(NOTE) This is also true for situations whereby the attacking team is penalized after the play has been stopped in the attacking zone by an act by the defending Team. The face-off would remain in the non-offending Team's end zone.

- (g) When an infringement of a rule has been committed by players of both sides in the play resulting in the stoppage, the ensuing face-off will be made at the place of such infringement or at the place where play is stopped.
- (h) When stoppage occurs between the end face-off spots and near end of the rink, the puck shall be faced-off at the end face-off spot on the side where the stoppage occurs unless otherwise expressly provided by these Rules.
- (i) No face-off shall be made within fifteen feet (15') of the goal or sideboards.
- (j) When a goal is illegally scored as a result of a puck being deflected directly off an Official anywhere in the defending zone, the resulting face-off shall be made at the end face-off spot in the defending zone.
- (k) When the game is stopped for any reason not specifically covered in the Official Rules, the puck must be faced-off where it was last played.
- (l) The whistle will not be blown by the Official to start play. Playing time will commence from the instant the puck is faced-off and will stop when the whistle is blown or a goal is scored.
- (m) Following a stoppage of play, should one or both defensemen who are the point players or any player coming from the bench of the attacking Team, enter

into the attacking zone beyond the outer edge of the end zone face-off circle during an altercation or "scrum", the ensuing face-off shall take place in the neutral zone near the blue line of the defending Team.

Rule 55. Falling on Puck

- (a) A minor penalty shall be imposed on a player other than the goalkeeper who deliberately falls on or gathers the puck into his body.

(NOTE) Any player who drops to his knees to block a shot should not be penalized if the puck is shot under him or becomes lodged in his clothing or equipment but any use of the hands to make the puck unplayable should be penalized promptly.

- (b) A minor penalty shall be imposed on a goalkeeper who, when he is in his own goal crease, deliberately falls on or gathers the puck into his body or who holds or places the puck against any part of the goal in such a manner as to cause a stoppage of play unless he is actually being checked by an opponent.

(NOTE) Refer to Rule 79(b) – Puck Must Be Kept In Motion for the Rule governing freezing of the puck by a goalkeeper outside of his crease area.

- (c) No defending player, except the goalkeeper, will be permitted to fall on the puck, hold the puck or gather the puck into the body or hands when the puck is within the goal crease.

For infringement of this Rule, play shall immediately be stopped and a penalty shot shall be ordered against the offending Team, but no other penalty shall be given.

(NOTE) The Rule shall be interpreted so that a penalty shot will be awarded only when the puck is in the crease at the instant the offense occurs. However, in cases where the puck is outside the crease, Rule 55(a) may still apply and a minor penalty may be imposed, even though no penalty shot is awarded.

Rule 56. Fisticuffs

An instigator of an altercation shall be a player who by his actions or demeanor demonstrates any/some of the following criteria: distance traveled; gloves off first; first punch thrown; menacing attitude or posture; verbal instigation or threats; conduct in retaliation to a prior game (or season) incident; obvious retribution for a previous incident in the game or season.

The aggressor in an altercation shall be the player who continues to throw punches in an attempt to inflict punishment on his opponent who is in a defenseless position or who is an unwilling combatant. A player must be deemed the aggressor when he has clearly won the fight but he continues throwing and landing

punches in a further attempt to inflict punishment and/or injury on his opponent who is no longer in a position to defend himself.

An altercation is a situation involving two players, with at least one to be penalized.

- (a) A major penalty shall be imposed on any player who fights.

A player who is deemed to be the instigator of an altercation shall be assessed an instigating minor penalty, a major for fighting and a ten minute misconduct.

A player who is deemed to be the instigator of an altercation will have this recorded as an instigator of an altercation for statistical and suspension purposes.

If the same player is deemed to be the instigator of a second altercation in the same game, he shall be assessed an instigating minor penalty, a major for fighting and a game misconduct.

A player who is deemed to be the aggressor of an altercation shall be assessed a major for fighting and a game misconduct.

A player who is deemed to be the aggressor of an altercation will have this recorded as an aggressor of an altercation for statistical and suspension purposes.

A player who is deemed to be both the instigator and aggressor of an altercation shall be assessed an instigating minor penalty, a major penalty for fighting, a ten minute misconduct penalty (instigator) and a game misconduct penalty (aggressor).

A player who is deemed to be the instigator of an altercation for the third time or the aggressor for the third time in one Regular Season shall be suspended for the next Regular Season game of his Team. For the fourth instigator penalty or fourth aggressor penalty in the same Regular Season, the player will be suspended for the next two (2) games of his Team. For the fifth instigator penalty or fifth aggressor penalty in the same Regular Season, the player will be suspended for the next three (3) games of his Team.

During the Playoffs, any player who is deemed to be the instigator of an altercation for the second time or the aggressor for the second time shall be suspended automatically for the next Playoff game of his Team. For each subsequent instigator or aggressor violation during the Playoffs, the automatic suspension shall be increased by one (1) game.

Prior to the commencement of each President's Cup Finals, a player will have his current instigator and

aggressor violations removed from his current playoff record. They will remain part of his historical record.

A player who deliberately removes his sweater prior to participating in an altercation or who is clearly wearing a sweater that has been modified and does not conform to Rule 24A – Players' Jerseys, shall be assessed a minor penalty for Unsportsmanlike Conduct and a game misconduct. This is in addition to other penalties to be assessed to the participants of an altercation.

A player who engages in fisticuffs and whose sweater is removed (completely off his torso), other than through the actions of his opponent in the altercation or through the actions of the Linesman, shall be assessed a game misconduct penalty.

A player who engages in fisticuffs and whose sweater is not properly "tied-down" (sweater properly fastened to pants), and who loses his sweater (completely off his torso) in that altercation, shall receive a game misconduct.

A player who is involved in an altercation, when the opponent has been identified as an instigator, shall not be assessed a game misconduct if his sweater should be removed by an opponent or an Official in the discharge of his duties.

- (b) A minor penalty shall be imposed on a player who, having been struck, shall retaliate with a blow or attempted blow. However, at the discretion of the Referee, a major or a double minor penalty or a game misconduct penalty may be imposed if such player continues the altercation.

(NOTE 1) It is the intent and purpose of this Rule that the Referee shall impose the "major and game misconduct" penalty in all cases where the instigator or retaliator of the fight is the aggressor and is plainly doing so for the purpose of intimidation or punishment. To further clarify, the player who starts the fight, and who then also becomes the aggressor shall be assessed an instigating minor penalty, a major penalty for fighting, a ten minute misconduct (instigator), and a game misconduct for being the aggressor.

(NOTE 2) The Referee is provided very wide latitude in the penalties which he may impose under this Rule. This is done intentionally to enable him to differentiate between the obvious degrees of responsibility of the participants either for starting the fighting or persisting in continuing the fighting. The discretion provided should be exercised realistically.

(NOTE 3) Referees are directed to employ every means provided by these Rules to stop "brawling" and should use this Rule and Rules 41(e) and (f) – Abuse of Officials and other Misconduct.

(NOTE 4) Any player wearing tape or any other material on his

hands (below the wrist) who cuts or injures an opponent during an altercation will receive a match penalty under Rule 43 – Attempt to or Deliberate Injury of Opponents in addition to any other penalties imposed including fighting under this rule.

- (c) A misconduct or game misconduct penalty shall be imposed on any player involved in fisticuffs off the playing surface or with another player who is off the playing surface. These penalties are in addition to any other time penalties assessed.
- (d) A game misconduct penalty, at the discretion of the Referee, shall be imposed on any player or goalkeeper who is the first to intervene in an altercation already in progress except when a match penalty is being imposed in the original altercation. This penalty is in addition to any other penalty incurred in the same incident.
- (e) When a fight occurs, all players not engaged shall go immediately to the area of their players' bench and in the event the altercation takes place at a players' bench, the players on the ice from that Team shall go to their defensive zone.

Failure to comply with the Rule shall, in addition to the other penalties that may be assessed, result in a fine to the Team of one hundred dollars (\$100) and the Coach of said Team in the amount of one hundred dollars (\$100).

- (f) A game misconduct penalty shall be imposed on any player who is assessed a major penalty for fighting after the original altercation.

Notwithstanding this Rule, at the discretion of the Referee, the automatic game misconduct penalty may be waived for a player in the altercation if the opposing player was clearly the instigator of the altercation.

- (g) Any Teams whose players become involved in an altercation, other than during the periods of the game, shall be fined automatically five hundred dollars (\$500) in addition to any other appropriate penalties that may be imposed upon the participating players by supplementary discipline or otherwise.

Any player who would be deemed to be an instigator pursuant to Rule 56(a) at a time other than during the periods of the game shall be suspended automatically for six (6) games. Such determination may be made by the Referee at the time of the incident or subsequently by the President or his designee based upon such reports and other information that he deems sufficient, including but not limited to television tapes.

(NOTE) In the case of altercations taking place after the period or

game the fine under this Rule shall be assessed only in the event that an altercation is commenced after the period or game has terminated.

Rule 57. Goals and Assists

(NOTE) It is the responsibility of the Official Scorer to award goals and assists, and his decision in this respect is final, notwithstanding the report of the Referee or any other game Official. Such awards shall be made or withheld strictly in accordance with the provisions of this Rule. Therefore, it is essential that the Official Scorer be thoroughly familiar with every aspect of this Rule; be alert to observe all actions which could affect the awarding of a goal or assist; and, above all, give or withhold awards with absolute impartiality.

In case of an obvious error in awarding a goal or an assist that has been announced, it should be corrected promptly, but changes should not be made in the Official Scoring Summary after the Referee has signed the Game Report.

- (a) A goal shall be scored when the puck shall have been put between the goal posts by the stick of a player of the attacking side, from in front and below the cross-bar, and entirely across a red line the width of the diameter of the goal posts drawn on the ice from one goal post to the other with the goal frame in its proper position. (See also Rule 51(c) – Delaying the Game.)

The goal frame is considered to be displaced if either or both goal peg(s) are no longer in their respective holes in the ice, or the net has come completely off the peg(s), prior to or as the puck enters the goal.

- (b) A goal shall be scored if the puck is put into the goal in any way by a player of the defending side. The player of the attacking side who last played the puck shall be credited with the goal but no assist shall be awarded.
- (c) A goal cannot be scored by an attacking player who deliberately bats the puck with any part of his body across the goal line. A goal cannot be scored where an attacking player bats the puck and it is deflected off any player or goalkeeper into the net.
- (d) If an attacking player has the puck deflect into the net, off his skate or body, in any manner, the goal shall be allowed. The player who deflected the puck shall be credited with the goal.

The goal shall not be allowed if the puck has been intentionally kicked with his skate or foot, using a distinct kicking motion, and subsequently enters the net.

A goal shall be allowed unless a distinct kicking motion is evident.

The goal shall not be allowed if the puck has been thrown or otherwise deliberately directed into the goal by any means other than a stick. (See also Rule 70 – Kicking the Puck.)

- (e) If a goal is scored as a result of being deflected directly into the net off an Official, the goal shall not be allowed. Refer to Rule 82 – Puck Striking Official.
- (f) Should a player legally propel a puck into the goal crease of the opponent club and the puck should become loose and available to another player of the attacking side, a goal scored on the play shall be legal.
- (g) Any goal scored, other than as covered by the Official Rules, shall not be allowed.
- (h) A "goal" shall be credited in the scoring records to a player who shall have propelled the puck into the opponent's goal. Each "goal" shall count one (1) point in the player's record.
- (i) When a player scores a goal, an "assist" shall be credited to the player or players taking part in the play immediately preceding the goal, but no more than two (2) assists can be given on any goal. Each "assist" shall count one (1) point in the player's record.
- (j) Only one point can be credited to any one (1) player on a goal.



WASH-OUT

Both arms swung laterally across the body with palms down. When used by the Referee, it means goal disallowed.

Rule 58. Gross Misconduct

The Referee may impose a "GROSS MISCONDUCT" penalty on any player, Manager, Coach or Trainer who is guilty of gross misconduct of any kind. Any person incurring a "gross misconduct" penalty shall be suspended for the balance of the game and shall incur an automatic fine of fifty dollars (\$50) and the case shall be referred to the President of the League for further disciplinary action. (See also Rule 28(d) – Misconduct Penalties.)

(NOTE) For all game misconduct and gross misconduct penalties regardless of when imposed, a total of ten (10) minutes shall be charged in the records against the offending player.

A gross misconduct penalty can be assessed for the following infractions:

- i) interfering with or striking a spectator.
 - ii) post-game verbal abuse from players or non-playing club personnel (on or off the ice)
 - iii) racial taunts or slurs
 - v) spitting on an opponent, or spectator
-

Rule 59. Handling Puck with Hands

- (a) If a player, except a goalkeeper, closes his hand on the puck, the play shall be stopped and a minor penalty shall be imposed on him. A player shall be permitted to catch the puck out of the air but must immediately place it or knock it down to the ice. If he catches it and skates with it, either to avoid a check or to gain a territorial advantage over his opponent, a minor penalty shall be assessed for "closing his hand on the puck".

A goalkeeper who holds the puck with his hands for longer than three (3) seconds shall be given a minor penalty unless he is actually being checked by an opponent.

- (b) A goalkeeper must not deliberately hold the puck in any manner which, in the opinion of the Referee, causes a stoppage of play, nor throw the puck forward towards the opponent's net, nor deliberately drop the puck into his pads or onto the goal net, nor deliberately pile up snow or obstacles at or near his net, that in the opinion of the Referee, would tend to prevent the scoring of a goal.

(NOTE) The object of this entire Rule is to keep the puck in play continuously and any action taken by the goalkeeper which causes an unnecessary stoppage must be penalized without warning.

- (c) The penalty for infringement of this Rule by the goalkeeper shall be a minor penalty.

(NOTE) In the case where the puck thrown forward by the goalkeeper being taken by an opponent, the Referee shall allow the resulting play to be completed, and if goal is scored by the non-offending Team, it shall be allowed and no penalty given; but if a goal is not scored, play shall be stopped and a minor penalty shall be imposed against the goalkeeper.

- (d) A minor penalty shall be imposed on a player, except the goalkeeper, who, while play is in progress, picks up the puck off the ice with his hand.

If a player, except a goalkeeper, while play is in progress, picks up the puck with his hand from the ice in the goal crease area, the play shall be stopped immediately and a penalty shot shall be awarded to the non-offending Team.

- (e) A player shall be permitted to stop or "bat" a puck in the air with his open hand, or push it along the ice

with his hand, and the play shall not be stopped unless, in the opinion of the Referee, he has directed the puck to a Teammate in any zone other than the defending zone, in which case the play shall be stopped and the puck faced-off at the spot where the offense occurred, except when the offense occurs in the attacking zone in which case the ensuing face-off shall be conducted outside the defending Team's blue line in the neutral zone.

Play will not be stopped for any hand pass by players in their own defending zone. A hand pass in the defending zone is considered to have occurred when both the player making the pass and the player receiving the pass have both of their skates inside their defending zone.

A goal cannot be scored by an attacking player who bats the puck with his hand directly into the net. A goal cannot be scored by an attacking player who bats the puck and it is deflected into the net off any player, goalkeeper or Official.

Rule 60. Head-Butting

- (a) A double minor penalty shall be imposed on a player who attempts to head-butt an opponent.
- (b) A major and a game misconduct penalty shall be imposed on a player who head-butts an opponent. (See also Rule 43 – Attempt to or Deliberate Injury of Opponents.)
- (c) A match penalty shall be imposed on a player who injures an opponent as a result of a head-butt. (See also Rule 43 – Attempt to or Deliberate Injury of Opponents.)

Rule 61. High Sticks

A "high stick" is one which is carried above the height of the opponent's shoulders. A player is permitted accidental contact on an opponent if the act is committed as a normal windup or follow through of a shooting motion.

- (a) Any contact made by a stick on an opponent above the shoulders is prohibited and a minor shall be imposed subject to section (b) of this Rule.
- (b) When a player carries or holds any part of his stick above the shoulders of the



opponent so that injury results, the Referee shall:

- (i) Assess a double minor penalty for all accidental contact that causes an injury, in the opinion of the Referee.
 - (ii) Assess a major penalty and a game misconduct to a player, excluding goalkeepers, who in the opinion of the Referee, is careless with his stick and makes contact with injury. When a major penalty is imposed under this rule, an automatic fine of twenty-five dollars (\$25) shall also be imposed.
 - (iii) Assess a match penalty to a player, who in the opinion of the Referee, attempted to injure an opponent. (See Rule 43 - Attempt to or Deliberate Injury of Opponents.)
 - (iv) Assess a match penalty to a player, who in the opinion of the Referee, deliberately injured an opponent. (See Rule 43 – Attempt to or Deliberate Injury of Opponents.)
- (c) An apparent goal scored by an attacking player when any part of his stick makes contact with the puck above the height of the crossbar of the goal frame shall not be allowed. The determining factor is where the puck makes contact with the stick. If the puck makes contact with the stick below the level of the crossbar and enters the goal, this goal shall be allowed.

A goal scored by a defending player who strikes the puck with his stick above the height of the crossbar of the goal frame shall be allowed.

- (d) Batting the puck above the normal height of the shoulders with a stick is prohibited. When a puck is struck with a high stick and subsequently comes into the possession of a Teammate, there shall be a whistle. If a territorial advantage is gained by the offending Team, the ensuing face-off will be where the high-stick occurred. If a territorial disadvantage occurs to the offending Team, the ensuing face-off will be where the puck is touched. Play continues following a high-sticked puck if:
- (1) the puck has been batted to an opponent in which case the play shall continue.
 - (2) a player of the defending side shall bat the puck into his own goal in which case the goal shall be allowed.

(NOTE) When a player bats the puck to an opponent under subsection 1, the Referee shall give the "washout" signal immediately. Otherwise, he will stop the play.

- (e) Following a high sticking the puck violation, if both teams abstain from touching the puck, the referee shall

blow the whistle and the ensuing face-off shall be where the play was stopped, regardless of which Team was responsible for contacting the puck with a high stick.

- (f) When either Team is below the numerical strength of its opponent and a player of the Team of greater numerical strength causes a stoppage of play by striking the puck with his stick above the height of his shoulder, the resulting face-off shall be made at one of the end zone face-off spots adjacent to the goal of the Team causing the stoppage.

Rule 62. Holding an Opponent

A minor penalty shall be imposed on a player who holds an opponent by using his hands, arms or legs.

(NOTE) A player is permitted to use his arm in a strength move, by blocking his opponent, provided he has body position and is not using his hands in a holding manner, when doing so.



HOLDING

Clasping the wrist of the "whistle hand" well in front of the chest.

Rule 63. Holding an Opponent's Stick

A player is not permitted to hold an opponent's stick. A minor penalty shall be assessed to a player who holds an opponent's stick.

(NOTE) A player is permitted to protect himself by defending against an opponent's stick. He must immediately release the stick and allow the player to resume normal play.

Rule 64. Hooking

Hooking is the act of using the stick in a manner that enables a player to restrain an opponent.

(NOTE) When a player is checking another in such a way that there is only stick-to-stick contact, such action is not to be penalized as hooking.

- (a) A minor penalty shall be imposed on a player who impedes the progress of an opponent by "hooking" with his stick.

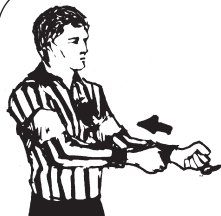

HOOKING

A tugging motion with both arms, as if pulling something toward the stomach.

- (b) A major penalty and a game misconduct shall be imposed on any player who injures an opponent by "hooking". A player who has been assessed a major penalty and a game misconduct under this Rule shall be automatically fined twenty-five dollars (\$25).
-

Rule 65. Icing the Puck

- (a) For the purpose of this Rule, the center red line will divide the ice into halves. Should any player of a Team, equal or superior in numerical strength to the opposing Team, shoot, bat or deflect the puck from his own half of the ice beyond the goal line of the opposing Team, play shall be stopped and the puck faced-off at the end face-off spot of the offending Team, unless on the play, the puck shall have entered the net of the opposing Team, in which case the goal shall be allowed.

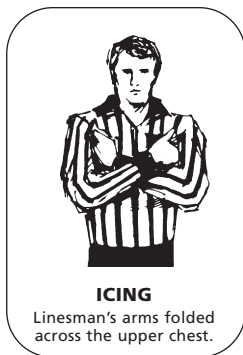

For the purpose of this Rule, the point of last contact with the puck by the Team in possession shall be used to determine whether icing has occurred or not. Icing the puck shall immediately occur the instant the puck completely crosses the opponents' goal line. As such, the Team in possession must "gain the line" in order for the icing to be nullified. "Gaining the line" shall mean that the puck (not the player's skate) must make contact with the center red line in order to fully nullify a potential icing.

(NOTE 1) If during the period of a delayed whistle due to a foul by a player of the side NOT in possession, the side in possession "ices" the puck, then the face-off following the stoppage of play shall take place in the neutral zone near the defending blue line of the Team icing the puck.

(NOTE 2) When a Team is "short-handed" as the result of a penalty and the penalty is about to expire, the decision as to whether there has been an "icing" shall be determined at the instant the penalty expires. The action of the penalized player remaining in the penalty box will not alter the ruling.

When a Team is "short-handed" by reason of a major penalty, and they have neglected to ensure there is a player on the penalty bench to exit upon the expiry of the penalty, they will continue to play short-handed but are not permitted to ice the puck. Icing will be called. They may substitute for this penalized player at the next stoppage of play.

(NOTE 3) For the purpose of interpretation of the Rule, "icing the puck" is completed the instant the puck crosses the goal line. The linesman shall immediately blow his whistle to signify icing once the puck has completely crossed the goal line. A defending player will not be required to touch the puck for icing to occur.

(NOTE 4) When the puck is shot and rebounds from the body or stick of an opponent in his own half of the ice so as to cross the goal line of the player shooting, it shall not be considered as "icing".

(NOTE 5) Notwithstanding the provisions of the section concerning "batting" the puck in respect to the "icing the puck" rule, the provisions of the final paragraph of Rule 59(e) apply and NO goal can be scored by batting the puck with the hand into the opponent's goal whether intended or not.

- (b) If the puck was so shot by a player of a side below the numerical strength of the opposing Team, play shall continue and the icing violation shall not be called.

(NOTE) If the Team returns to full strength following a shot by one of its players, play shall continue and the face-off shall not take place.

- (c) If, however, the puck shall go beyond the goal line in the opposite half of the ice directly from either of the players while facing-off, it shall not be considered a violation of this Rule.
- (d) If, in the opinion of the Linesmen, any player of the opposing Team is able to play the puck before it passes his goal line, but has not done so, play shall continue and the icing violation shall not be called. If, in the opinion of the Referee, the defending side intentionally abstains from playing the puck promptly when they are in a position to do so, he shall stop the play and order the resulting face-off on the adjacent corner face-off spot nearest the goal of the Team at fault. If, in the opinion of the Linesman, the goalkeeper feigns playing the puck or skates in the direction of the puck on an icing at any time, the potential icing shall not be called and play shall continue.

NEW

The Linesman shall have discretion to wave off apparent icing infractions on attempted passes are deemed receivable.

(NOTE) The purpose of this section is to enforce continuous action and both Referee and Linesmen should interpret and apply the Rule to produce this result. If, however, a goalkeeper is legitimately out of the net in an attempt to go to the players' bench to be substituted for an extra attacker and in no way makes an attempt to play the puck, the icing should not be nullified under this section.

- (e) If the puck touches any part of a player of the opposing side, including his skates or his stick, or if it touches any part of the opposing Team's goalkeeper, includ-

ing his skates or his stick, at any time before crossing the goal line, it shall not be considered icing.

- (f) If the Linesman shall have erred in calling an "icing the puck" infraction (regardless of whether either Team is short-handed), the puck shall be faced-off on the center ice face-off spot.
-

Rule 66. Illegal Puck

If at any time while play is in progress, a puck other than the one legally in play shall appear on the playing surface, the play shall not be stopped but shall continue with the legal puck until the play then in progress is completed by change of possession.

Rule 67. Interference

(NOTE) A strict standard of interference must be adhered to in all areas of the rink, WITH EMPHASIS ON INTERFERENCE IN THE NEUTRAL ZONE.

- (a) A minor penalty shall be imposed on a player who interferes with or impedes the progress of an opponent who is not in possession of the puck.
- (b) A minor penalty shall be imposed on a player who restrains an opponent who is attempting to "forecheck".
- (c) A minor penalty shall be imposed on an attacking player who deliberately checks a defensive player. Including the goalkeeper, who is not in possession of the puck.
- (d) A minor penalty shall be imposed on a player who shall cause an opponent who is not in possession of the puck to be forced off-side, causing a stoppage in play.
- (e) A minor penalty shall be imposed on a player who deliberately knocks a stick out of an opponent's hand, or who prevents a player who has dropped his stick or any other piece of equipment from regaining possession of it.
- (f) A minor penalty shall be imposed on a player who knocks or shoots any abandoned or broken stick or illegal puck or other debris towards an opposing puck carrier in a manner that could cause him to be distracted. (See also Rule 88(a) – Throwing Stick.)
- (g) A minor penalty shall be imposed on any player on



the players' bench or penalty bench who, by means of his stick or his body, interferes with the movements of the puck or any opponent on the ice during the progress of the play.

(NOTE) The appropriate penalty according to the playing rules shall be assessed when a player on the players' or penalty bench becomes involved with an opponent on the ice during a stoppage in play. The player(s) involved may be subject to additional sanctions as appropriate pursuant to Rule 33A – Supplementary Discipline.

- (h) If, when the goalkeeper has been removed from the ice, any member of his Team (including the goalkeeper) not legally on the ice, including the Manager, Coach or Trainer, interferes by means of his body, stick or any other object with the movements of the puck or an opposing player, the Referee shall immediately award a goal to the non-offending Team.
- (i) When a player in control of the puck on his opponent's side of the center red line and having no other opponent to pass than the goalkeeper is interfered with by a stick or any part thereof or any other object thrown or shot by any member of the defending Team including the Manager, Coach or Trainer, a penalty shot shall be awarded to the non-offending Team.

(NOTE 1) Body Position:

Body position shall be determined as the player skating in front of or beside his opponent, traveling in the same direction. A player who is behind an opponent, who does not have the puck, may not use his stick or body in order to restrain his opponent, but must skate in order to gain or reestablish his proper position in order to make a check.

A player is allowed the ice he is standing on (body position) and is not required to move in order to let an opponent proceed. A player may "block" the path of an opponent provided he is in front of his opponent and moving in the same direction. Moving laterally and without establishing body position, then making contact with the non-puck carrier is not permitted and will be penalized as interference. A player is always entitled to use his body position to lengthen an opponent's path to the puck, provided his stick is not utilized (to make himself "bigger" and therefore considerably lengthening the distance his opponent must travel to get to where he is going); his free hand is not used and he does not take advantage of his body position to deliver an otherwise illegal check.

(NOTE 2) Possession of the Puck:

The last player to touch the puck, other than the goalkeeper, shall be considered the player in possession. The player deemed in possession of the puck may be checked legally, provided the check is rendered immediately following his loss of possession.

(NOTE 3) Restrain:

The actions of a player who does not have body position, but instead

uses illegal means (e.g. hook with stick; hold with hands; trip with the stick or in any manner) to impede an opponent who is not in possession of the puck. Illegal means are acts which allow a player to establish, maintain or restore body position, other than by skating.

(NOTE 4) *Pick:*

A "pick" is the action of a player who checks an opponent who is not in possession of the puck and is unaware of the impending check/hit. A player who is aware of an impending hit, not deemed to be a legal "battle for the puck", may not be interfered with by a player delivering a "pick". A player delivering a "pick" is one who moves into an opponent's path without initially having body position, thereby taking him out of the play. When this is done, an interference penalty shall be assessed.

(NOTE 5) *Free Hand:*

A free hand is the one that is not evident holding the player's own stick. The free hand may be used by a player to "fend off" an opponent or his stick, but may not be used to hold an opponent's stick or body.

(NOTE 6) *Stick:*

A player who does not have body position on his opponent, who uses his stick (either the blade or the shaft, including the butt end of the shaft) to impede or prevent his opponent from moving freely on the ice shall be assessed a hooking penalty.

Rule 68. Interference by/with Spectators

- (a) In the event of a player being held or interfered with by a spectator, the Referee or Linesman shall blow the whistle and play shall be stopped unless the Team of the player interfered with is in possession of the puck. The play shall be allowed to be completed before blowing the whistle and the puck shall be faced-off where play was stopped.
- (b) Any player, Trainer, Manager, Coach or club executive who physically interferes with the spectators shall automatically incur a gross misconduct penalty and the Referee shall report all such infractions to the President who shall have full power to impose such further penalty as he shall deem appropriate.
- (c) In the event that objects are thrown on the ice that interfere with the progress of the game, the Referee shall blow the whistle and stop the play and the puck shall be faced-off at the spot where play is stopped.

(NOTE 1) *In the event that objects are thrown on the ice during a stoppage in play, including after the scoring of a goal (unless approved by the League Office), the Referee shall have announced that any further occurrences will result in a bench minor penalty being assessed to the home Team.*

(NOTE 2) *The Referee shall report to the President for disciplinary action all cases in which a player becomes involved in an altercation with a spectator.*

Rule 69. Kicking a Player

A match penalty shall be imposed on any player who kicks or attempts to kick another player.

Whether or not an injury occurs, the Referee will impose a five (5) minute time penalty under this Rule. Refer to Rule 43 – Attempt to or Deliberate Injury of Opponents.

Rule 70. Kicking the Puck

- (a) Kicking the puck shall be permitted in all zones. A goal cannot be scored by an attacking player who uses a distinct kicking motion to propel the puck into the net. A goal cannot be scored by an attacking player who kicks a puck that deflects into the net off any player, goalkeeper or Official.
- (b) A puck that deflects into the net off of an attacking player who does not use a distinct kicking motion, is a legitimate goal.

(NOTE) The following should clarify deflections following a kicked puck that enters the goal:

- (i) A kicked puck that deflects off the body of any player of either team (including the goalkeeper) shall be ruled NO GOAL.
- (ii) A kicked puck that deflects off ANY stick (excluding the goalkeeper's stick) shall be ruled a GOOD GOAL. After the puck has been kicked, makes contact with any stick and then deflects off any player (excluding the goalkeeper) and into the net will still be ruled a GOOD GOAL.
- (iii) The player who kicks the puck and has the puck deflect off his OWN stick and then into the net, this will be ruled a GOOD GOAL.
- (c) A goal cannot be scored by an attacking player who kicks any equipment (stick, glove, helmet, etc.) at the puck, causing the puck to cross the goal line.

Rule 71. Kneeing

Kneeing is the act of a player leading with his knee and in some cases extending his leg outwards to make contact with his opponent.

A minor, major or match penalty shall be imposed on any player who fouls an opponent by kneeing.

When a player has been assessed a major penalty for kneeing he shall also be assessed a game misconduct.

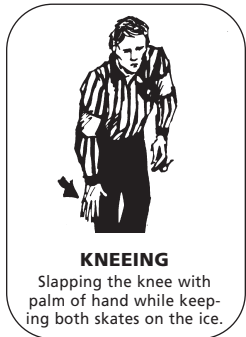

Rule 72. Leaving the Players' or Penalty Bench

- (a) No player may leave the players' or penalty bench at any time during an altercation or for the purpose of starting an altercation. Substitutions made prior to the altercation shall be permitted provided the players so substituting do not enter the altercation. A player who has entered the game on a legal line change and starts an altercation will be subjected to discipline in accordance with Rule 33A - Supplementary Discipline.

A player or players who have entered the game on a legal line change during a stoppage of play, who line up in preparation for the ensuing face-off, and who participate in an altercation prior to the drop of the puck, shall be assessed a major penalty for fighting and a game misconduct under Rule 41(f), and may be subject to discipline in accordance with Rule 33A – Supplementary Discipline.

- (b) For violation of this Rule, a game misconduct penalty shall be imposed on the player who was the first or second player to leave the players' or penalty bench from either or both Teams.
- (c) The first player to leave the players' or penalty bench, whether play is in progress or not, from either or both Teams during an altercation or for the purpose of starting an altercation whereby by subsequent altercation(s) occur, shall be suspended automatically for the next six (6) regular League and/or playoff games of his Team. All other instances of player(s) leaving the players' or penalty bench, whether play is in progress or not, for the purpose of starting an altercation will be subject to discipline in accordance with Rule 33A – Supplementary Discipline.
- (d) The second player to leave the bench from either or both Teams shall be suspended automatically for the next three (3) regular League and/or playoff games.

(NOTE) The determination as to the players penalized under (c) and (d) of this Rule shall be made by the Referee in consultation with the Linesmen and Off-Ice Officials. In the event that he is unable to identify the offending players, the matter will be referred to the President or his designee and such determinations may be made subsequently based on reports and other information including but not limited to videotapes.

- (e) Any Team that has a player penalized under (a) shall be fined automatically one hundred dollars (\$100), and the player shall be fined automatically twenty-five dollars (\$25).

- (f) All players including the first and second players who leave the bench during an altercation shall be subject to 33(A) - Supplementary Discipline in addition to the automatic fines and suspensions.
- (g) Any player who leaves the penalty bench during an altercation and is not the first player to do so, shall be suspended automatically for the next three (3) regular League and/or playoff games.
- (h) Except at the end of each period or on expiration of his penalty, no player may, at any time, leave the penalty bench.

Any player who, having entered the penalty bench, leaves the penalty bench prior to the expiration of his penalty for the purpose of challenging an Official's ruling, shall be assessed a game misconduct penalty. He shall also be automatically suspended for the next two (2) regular League and/or playoff games of his club. This rule does not replace any other more severe penalty that may be imposed for leaving the penalty bench for the purpose of starting or participating in an altercation as outlined in this Rule 72.

(NOTE) Once a player enters the penalty bench, he must not leave until his penalty expires and his team is entitled to an additional player on the ice, or, at the end of a period to proceed to this dressing room, or, when he has received permission from an On-Ice Official. At any other time, he shall be assessed a game misconduct penalty under this rule.

- (i) A penalized player who leaves the penalty bench before his penalty has expired, whether play is in progress or not, shall incur an additional minor penalty, after serving his unexpired penalty.
- (j) Any penalized player leaving the penalty bench during stoppage of play and during an altercation shall incur a minor penalty plus a game misconduct penalty after serving his unexpired time.
- (k) If a player leaves the penalty bench before his penalty is fully served, the Penalty Timekeeper shall note the time and signal the Officials who will stop play when the offending player's Team obtains possession of the puck.
- (l) In the case of a player returning to the ice before his time has expired through an error of the Penalty Timekeeper, he is not to serve an additional penalty, but must serve his unexpired time.
- (m) If a player of the attacking side in possession of the puck shall be in such a position as to have no opposition between him and the opposing goalkeeper, and while in such position he shall be interfered with by a

player of the opposing side who shall have illegally entered the game, the Referee shall impose a penalty shot against the side to which the offending player belongs.

- (n) If the opposing goalkeeper has been removed and a player throws or shoots any part of a stick or any other object at the puck or puck carrier, or if the puck carrier is fouled from behind, thereby being prevented from having a clear shot on an open goal, a goal shall be awarded to the attacking Team.

If, when the opposing goalkeeper has been removed from the ice, a player of the side attacking the unattended goal is interfered with by a player who shall have entered the game illegally, the Referee shall immediately award a goal to the non-offending Team.

- (o) If a Coach or Manager gets on the ice after the start of a period and before that period is ended, the Referee shall impose a bench minor penalty against the Team and report the incident to the President for disciplinary action.
- (p) Any club executive or Manager committing the same offense will be automatically fined two hundred dollars (\$200).
- (q) If a penalized player returns to the ice from the penalty bench before his penalty has expired by his own error or the error of the Penalty Timekeeper, any goal scored by his own Team while he is illegally on the ice shall be disallowed but all penalties imposed on either Team shall be served as regular penalties.
- (r) If a player shall illegally enter the game from his own players' bench or from the penalty bench, any goal scored by his own Team while he is illegally on the ice shall be disallowed but all penalties imposed on either Team shall be served as regular penalties.
- (s) A bench minor penalty shall be imposed on a Team whose player(s) leave the players' bench for any purpose other than a change of players and when no altercation is in progress.
- (t) Any player who has been ordered to the dressing room by the Officials and returns to his bench or to the ice surface for any reason before the appropriate time shall be subject to discipline in accordance with Rule 33A – Supplementary Discipline.
- (u) The Coach(es) of the Team(s) whose player(s) left the players' bench(es) during an altercation may be suspended, pending a review by the President. The Coach(es) also may be fined a maximum of one thousand dollars (\$1,000).

(NOTE) In the event that suspensions imposed under this Rule cannot be completed in regular League and/or playoff games in any one season, the remainder of the suspension shall be served the following season.

Rule 73. Obscene Language or Gestures

- (a) Players shall not use obscene gestures on the ice or anywhere in the rink before, during or after the game. For violation of this Rule, a game misconduct penalty shall be imposed and the Referee shall report the circumstances to the President of the League for further disciplinary action.

(NOTE) It is the responsibility of all game officials and all club officials to send a confidential report to the President setting out the full details concerning the use of obscene gestures or language by any player, Coach or other official. The President shall take such further disciplinary action as he shall deem appropriate.

- (b) Club Executives, Managers, Coaches and Trainers shall not use obscene language or gestures anywhere in the rink. For violation of this Rule, a bench minor penalty shall be imposed. Should this behavior continue, a game misconduct penalty shall be imposed and a confidential report to the President shall be completed and filed with the League for possible further disciplinary action.

Rule 74. Off-Sides

- (a) The position of the player's skates and not that of his stick shall be the determining factor in all instances in deciding an off-side. A player is off-side when both skates are completely over the outer edge of the blue line involved in the play.

(NOTE 1) A player is on-side when either of his skates are in contact with, or on his own side

of the line, at the instant the puck completely crosses the outer edge of that line regardless of the position of his stick. However, if while an off-side call is delayed, players of the offending team clear the zone, the Linesman shall drop his arm and the play is no longer off-side.

(NOTE 2) It should be noted that while the position of the player's skates is what determines whether a player is "off-side", nevertheless the question of an "off-side" never arises until the puck has completely crossed the outer edge of the line at which time the decision is to be made.

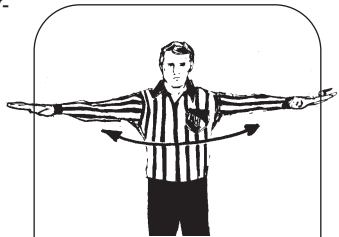

WASH-OUT

Both arms swung laterally at shoulder level with palms down. When used by the Linesman, it means no icing or no off-side.

- (b) If while an off-side call is delayed, the Linesman shall drop his arm to nullify the off-side violation and allow play to continue if:
 - (i) All players of the offending Team clear the zone at the same instant (skate contact with the blue line) permitting the attacking players to re-enter the attacking zone, or
 - (ii) The defending Team passes or carries the puck into the neutral zone.
- (c) If the attacking Team does not clear the attacking zone, play shall be stopped for the off-side violation if any attacking player touches the puck, or attempts to gain possession of a loose puck while the puck is still in the attacking zone, or forces the defending puck carrier further back into the attacking zone.

(NOTE) If the puck enters the defending Team's goal during a delayed off-side, the goal is disallowed. The face-off will be in the neutral zone.

- (d) If in the opinion of the Linesman, an intentional off-side play has been made, the puck shall be faced-off at the end face-off spot in the defending zone of the offending Team.

(NOTE 1) An intentional off-side is one which is made for the purpose of securing a stoppage of play regardless of the reason, whether either Team is short-handed.

(NOTE 2) If, while an off-side call is delayed, a player of the offending Team deliberately touches the puck to create a stoppage of play, the Linesman will signal an intentional off-side.

NEW Rule 75. Passes

- (a) The puck may be passed by any player to a player on the same Team within any one of the three zones into which the ice is divided.
- (b) Should the puck, after having been passed, contact any part of the body, stick or skate of a player on the Team who is legally on-side, the pass shall be considered complete.
- (c) The player last touched by the puck shall be deemed to be in possession.

Rebounds off goalkeepers' pads or other equipment shall not be considered as a change of possession or completion of the play by the Team when applying Rule 33(b) – Calling of Penalties.

- (d) If a player in the neutral zone is preceded in the attacking zone by the puck passed from the neutral zone, he shall be eligible to take possession of the puck anywhere in the attacking zone except when the "icing the puck" rule applies.

Rule 76. Physical Abuse of Officials

- (a) Any player who deliberately applies physical force in any manner against an Official, in any manner attempts to injure an Official, physically demeans, or deliberately applies physical force to an Official solely for the purpose of getting free of such an Official during or immediately following an altercation shall receive a game misconduct penalty.

In addition, the following disciplinary penalties shall apply:

CATEGORY I

Any player who deliberately strikes an Official and causes injury or who deliberately applies physical force in any manner against an Official with intent to injure, or who in any manner attempts to injure an Official shall be automatically suspended for not less than fourteen (14) games. (For the purpose of the Rule, "intent to injure" shall mean any physical force which a player knew or should have known could reasonably be expected to cause injury.)

CATEGORY II

Any player who deliberately applies excessive physical force to an Official in any manner (excluding actions as set out in Category I), which physical force is applied without intent to injure, shall be automatically suspended for not less than six (6) games.

CATEGORY III

Any player who, by his actions, physically demeans an Official or physically threatens an Official by (but not limited to) throwing a stick or any other piece of equipment or object at or in the general direction of an Official, shooting the puck at or in the general direction of an Official, spitting at or in the direction of an Official, or who deliberately applies physical force to an Official solely for the purpose of getting free of such an Official during or immediately following an altercation shall be suspended for not less than two (2) games.

Immediately after the game in which such game misconduct penalty is imposed, the Referee shall, in consultation with the Linesmen, decide the category of the offense. He shall make an oral report to the President and advise of the category and of the offense. In addition, he shall file a written report to the President in which he may request a review as to the adequacy of the suspension. The player and club involved shall be notified of the decision of the Referee on the morning fol-

lowing the game and the player may request the President to review, subject to the provisions of this Rule, the penalty imposed by the Referee. Such request must be filed with the President in writing not later than seventy-two (72) hours following notification of the penalty.

The penalties imposed under this Rule shall not be deemed to limit the right of the President with respect to any action that he might otherwise take under Rule 33A - Supplemental Discipline or under the CHL Lex Scripta.

In the event that the player has committed more than one offense under this Rule, in addition to the penalties imposed under this offense, his case shall be referred to the President of the League for consideration of supplementary disciplinary action.

(In all instances where the President is referred to in this Rule, it shall mean the President or his designee.)

- (b) Any Club Executive, Manager, Coach or Trainer who holds or strikes an Official shall be automatically suspended from the game, ordered to the dressing room and the matter will be reported to the President for further disciplinary action.

Rule 77. Preceding Puck into Attacking Zone

(NOTE) During a delayed off-side situation any offensive player(s) deemed to be in the attacking zone prior to the puck must "tag up" making skate contact with the blue line before re-entering the attacking zone.

- (a) Players of the attacking Team must not precede the puck into the attacking zone.
- (b) For violation of this Rule, the play is stopped and the puck shall be faced-off in the neutral zone at the face-off spot nearest the attacking zone of the offending Team.

(NOTE) A player actually controlling the puck who shall cross the line ahead of the puck shall not be considered "off-side".

- (c) If a player or players precede the puck into the attacking zone, the Linesman shall raise his arm to indicate a delayed off-side call. The Linesman shall drop his arm to nullify the off-side violation and allow play to continue if:

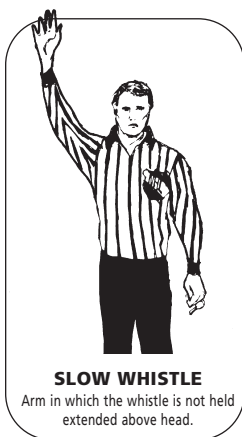

- (i) The defending Team passes or carries the puck into the neutral zone, or
 - (ii) All attacking players in the attacking zone (at the time the puck crosses the blue line) clear the attacking zone by making skate contact with the blue line. All attacking players must be clear of the zone at the same instant before the linesman can drop his arm permitting the attacking players to re-enter the attacking zone.
- (d) If the puck is shot on goal, during a delayed off-side, the play shall be allowed to continue under the normal clearing of the zone. Should the puck enter the net in this situation, either directly or off the goalkeeper, or a player or official on the ice, the goal shall not be allowed as the original shot was off-side.
- (e) For all delayed off-sides, including intentional off-sides, the Linesman will raise his non-whistle arm. He will allow play to continue and, if a stoppage of play occurs, there will be three possible face-off locations:
- (i) When an intentional off-side has been called, the face-off location will be on the face-off spot of the offending Team's defensive zone.
 - (ii) If an errant pass or shoot-in makes unintentional contact with an attacking player who preceded the puck into the attacking zone, the whistle shall be blown and the ensuing face-off shall take place at the location from where the pass or shot originated.
 - (iii) If the defending player is about to be checked, by an attacking player who is unaware that he is in an off-side position, the ensuing face-off shall take place on a neutral zone face-off spot nearest to the defending Team's blue line.

(NOTE 1) An intentional off-side is one which is made for the purpose of securing a stoppage of play regardless of the reason.

(NOTE 2) If, while an off-side call is delayed, a player of the offending Team deliberately touches the puck to create a stoppage of play; or, when a player deliberately carries the puck into the attacking zone when he knows that players from his team are in an off-side position; the Linesman will signal an intentional off-side.

(NOTE 3) An intentional off-side is still in effect when a Team is short-handed.

(NOTE 4) If a delayed off-side has been signaled, the non-offending player must carry or pass the puck towards and into the neutral zone. If he does not, the whistle shall be blown and the face-off take place in the neutral zone at a spot nearest the defending Team's blue line.

(NOTE 5) In the case of a delayed off-side being signaled, and the

puck goes out of play as a result of the pass or shot by the attacking player, the ensuing face-off shall be from the point at which the pass or shot originated.

(NOTE 6) A puck that deflects back into the defensive zone off of an Official who is in the neutral zone will be off-side (or a delayed off-side, as appropriate).

- (f) If a player legally carries or passes the puck back into his own defensive zone while a player of the opposing Team is in such defensive zone, the off-side shall be ignored and play permitted to continue.

(NOTE) If a puck clearly deflects off a defensive player in the neutral zone back into the defensive zone, all attacking players are eligible to play the puck.

Rule 78. Protection of Goalkeeper

The crease rule is based on the premise that an attacking player's position, whether inside or outside the crease, should not, by itself, determine whether a goal should be allowed or disallowed - i.e., goals scored while attacking players are standing in the crease may, in appropriate circumstances be allowed. Goals should be disallowed only if: (1) an attacking player, either by his positioning or by contact, impairs the goalkeeper's ability to move freely within his crease or defend his goal; or (2) an attacking player initiates more than incidental contact with a goalkeeper, inside or outside of his goal crease. Incidental contact with a goalkeeper will be permitted, and resulting goals allowed, when such contact is initiated outside of the goal crease, provided the attacking player has made a reasonable effort to avoid such contact.

- (a) If an attacking player initiates contact with a goalkeeper, incidental or otherwise, while the goalkeeper is in his goal crease, and a goal is scored, the goal will be disallowed.
- (b) If an attacking player initiates any contact with a goalkeeper, other than incidental contact, while the goalkeeper is outside his goal crease, and a goal is scored, the goal will be disallowed.
- (c) In all cases in which an attacking player initiates other than incidental contact with a goalkeeper, whether or not the goalkeeper is inside or outside the goal crease, and whether or not a goal is scored, the offensive player will receive a penalty (minor or major, as the Referee deems appropriate). (See also rule 47(c) – Charging).

(NOTE 1) In exercising his judgment under subsections (a) and (b) above, the Referee should give more significant consideration to the degree and nature of the contact with the goalkeeper than to the

exact location of the goalkeeper at the time of the contact.

(NOTE 2) If an attacking player has been pushed, shoved, or fouled by a defending player so as to cause him to come into contact with the goalkeeper, such contact will not be deemed to be contact initiated by the attacking player for purposes of this rule, provided the attacking player has made a reasonable effort to avoid such contact.

(NOTE 3) A goalkeeper is not "fair game" just because he is outside the goal crease. The appropriate penalty should be assessed in every case where an attacking player makes unnecessary contact with the goalkeeper. However, incidental contact will be permitted when the goalkeeper is in the act of playing the puck outside his goal crease provided the attacking player has made a reasonable effort to avoid such unnecessary contact.

- (d) If (i) a goalkeeper initiates contact with an offensive player who is in the goal crease; and (ii) such contact is (a) initiated by the goalkeeper in order to establish position in his goal crease; and (b) results in an impairment of the goalkeeper's ability to defend his goal, and a goal is scored, the goal will be disallowed.
- (e) If, after any contact by a goalkeeper who is attempting to establish position in his goal crease, the attacking player does not immediately vacate his current position in the goal crease (i.e. give ground to the goalkeeper), and a goal is scored, the goal will be disallowed. In all such cases, whether or not a goal is scored, the offensive player will receive a minor penalty for goalkeeper interference.

(NOTE 1) The overriding rationale of subsections (d) and (e) above is that a goalkeeper should have the ability to move freely within his goal crease without being hindered by the actions of an attacking player.

(NOTE 2) If, while attempting to establish position within his goal crease, a goalkeeper commits an act that is worthy of a penalty (i.e. cross-checking, slashing, etc.), then the appropriate penalty shall be assessed by the Referee.

- (f) When a goalkeeper has played the puck outside of his crease and is then prevented from returning to his crease area due to the deliberate actions of an attacking player, such player may be penalized for goalkeeper interference. Similarly, the goalkeeper may be penalized, if by his actions outside of his crease he deliberately interferes with an attacking player who is attempting to play the puck or an opponent.
- (g) If an attacking player establishes a significant position within the goal crease, so as to obstruct the goalkeeper's vision and impair his ability to defend his goal, and a goal is scored, the goal will be disallowed.

(NOTE) For this purpose, a player "establishes a significant posi-

tion within the crease" when, in the Referee's judgment, his body, or a substantial portion thereof, is within the goal crease for more than an instantaneous period of time.

- (h) Subject to (i) below, if an attacking player enters the goal crease and, by his actions, impairs the goalkeeper's ability to defend his goal, and a goal is scored, the goal will be disallowed.
- (i) In a rebound situation, or where a goalkeeper and offensive player(s) are simultaneously attempting to play a loose puck, whether inside or outside the crease, incidental contact with the goalkeeper will be permitted, and any goal that is scored as a result thereof will be allowed.
- (j) In the event that a goalkeeper has been pushed into the net together with the puck after making a stop, the goal will be disallowed. If applicable, appropriate penalties will be assessed.

In the event that the puck is under a player in or around the crease area (deliberately or otherwise), a goal cannot be scored by pushing this player together with the puck into the goal. If applicable, the appropriate penalties will be assessed, including a penalty shot if deemed to be covered in the crease deliberately (see Rule 55(c) – Falling on Puck).

- (k) A goalkeeper who deliberately initiates contact with an attacking player other than to establish position in the crease, or who otherwise acts to create the appearance of other than incidental contact with an attacking player, is subject to the assessment of a minor penalty for unsportsmanlike conduct.
- (l) An attacking player who, in the judgment of the Referee, initiates contact with the goalkeeper, whether inside or outside the crease, in a fashion that would otherwise warrant a penalty, will be assessed an appropriate penalty (minor or major and/or game misconduct) and will be subject to additional sanctions as appropriate pursuant to Rule 33A – Supplementary Discipline.

(NOTE 1) For purposes of this rule, "contact", whether incidental or otherwise, shall mean any contact that is made between or among a goalkeeper and attacking player(s), whether by means of a stick or any part of the body.

(NOTE 2) The above-stated standards relating to when a goal will be disallowed will be applied in all situations in which the puck enters the net regardless of whether it was directed into the net by the attacking or defensive Team.

- (m) Whenever the Referee stops play to disallow a goal as a result of contact with the goalkeeper (incidental or

otherwise), the resulting face-off shall take place at the nearest neutral zone face-off spot outside the attacking zone of the offending Team.

Rule 79. Puck Must Be Kept in Motion

- (a) The puck must be kept in motion at all times.
- (b) A minor penalty shall be imposed on any player, including the goalkeeper, who holds, freezes or plays the puck with his stick, skates or body in such a manner as to deliberately cause a stoppage of play.

(NOTE 1) With regard to a goalkeeper, this Rule applies outside of his goal crease area.

(NOTE 2) If a goalkeeper comes out of his crease to "cut down the angle" on a shot and after making the save covers the puck, this shall be legal. If the goalkeeper races out of his crease in an attempt to beat the attacking player to the puck and instead of playing the puck jumps on the puck causing a stoppage of play, this shall be a minor penalty for Delay of Game.

(NOTE 3) The overall intent of this rule is to keep the play going.

Rule 80. Puck Out of Bounds or Unplayable

- (a) When a puck goes outside the playing area at either end or either side of the rink, or strikes any obstacles above the playing surface other than the boards or glass, it shall be faced-off where it was shot or deflected out of play.

Notwithstanding this Rule, should an attacking player cause the puck to go out of play or become unplayable in the attacking zone, the face-off shall take place at a neutral zone face-off spot or the point from which the puck left the ice, whichever is less advantageous to the attacking Team.

Any loss of time on the game or penalty clocks due to the puck going out of play must be replaced.

(NOTE) Should the puck strike the spectator netting at the ends and the corners of the arena, play shall be stopped and the ensuing face-off shall be determined as if the puck went outside of the playing area. However, if the puck striking the spectator netting goes unnoticed by the On-Ice Officials, play shall continue as normal and resulting play with the puck shall be deemed as legitimate play. Players must not stop playing the game until they hear the whistle to do so.

- (b) When the puck becomes lodged in the netting on the outside of either goal so as to make it unplayable, or if it is "frozen" between opposing players intentionally or otherwise, the Referee shall stop the play and face-off the puck at either of the adjacent face-off spots unless in the opinion of the Referee, the stoppage was caused

by the attacking Team, in which case the resulting face-off shall be conducted in the neutral zone.

(NOTE) The defending Team and/or the attacking Team may play the puck off the net at any time. However, should the puck remain on the net for more than three (3) seconds, play shall be stopped and the face-off shall take place in the end zone, corner face-off spot, except when the stoppage is caused by the attacking Team, in which case the face-off shall take place on a face-off spot in the neutral zone.

- (c) A minor penalty shall be imposed on a goalkeeper who deliberately drops the puck on the goal netting to cause a stoppage of play.
 - (d) If the puck comes to rest on top of the boards surrounding the playing area, it shall be considered to be in play and may be played legally by hand or stick.
-

Rule 81. Puck Out of Sight

Should a scramble take place or a player accidentally fall on the puck and the puck be out of sight of the Referee, he shall immediately blow his whistle and stop the play. The puck shall then be faced-off at the point where the play was stopped unless otherwise provided for in the Rules.

Rule 82. Puck Striking Official

- (a) Play shall not be stopped if the puck touches an Official anywhere on the rink, regardless of whether a Team is shorthanded or not. A puck that deflects back into the defensive zone off an Official who is in the neutral zone, will be deemed to be off-side as per Rule 74 – Off-Side.
 - (b) When a puck deflects off an Official and goes out of play, the ensuing face-off will take place at the spot where the puck deflected off the Official.
(NOTE) If a goal is scored as a result of being deflected directly into the net off an Official, the goal shall not be allowed.
 - (c) When a goal is illegally scored as a result of a puck being deflected directly off an Official anywhere in the defending zone, the resulting face-off shall be made at the end face-off spot in the defending zone.
-

Rule 83. Refusing to Start Play

- (a) If, when both Teams are on the ice, one Team for any reason shall refuse to play when ordered to do so by the Referee, he shall warn the Captain and allow the Team so refusing fifteen (15) seconds within which to begin the play or resume play. If at the end of that time, the Team shall still refuse to play, the Referee shall impose a bench minor penalty for delay of game
-

on a player of the offending Team to be designated by the Manager or Coach of that Team through the playing Captain. Should there be a repetition of the same incident, the Referee shall notify the Coach that he has been fined the sum of fifty dollars (\$50). The offending Coach shall be removed from the players' bench and assessed a game misconduct penalty.

Should the offending Team still refuse to play, the Referee shall have no alternative but to declare that the game be forfeited to the non-offending club and the case shall be reported to the President for further action.

- (b) If a Team, when ordered to do so by the Referee through its club executive, Manager or Coach, fails to go on the ice and start play within five (5) minutes, the club executive, Manager or Coach shall be fined one hundred dollars (\$100), the game shall be forfeited and the case shall be reported to the President for further action.

(NOTE) The President of the League shall issue instructions pertaining to records, etc., of a forfeited game.

Once the club executive, Manager or Coach has been notified of the five (5) minute warning, and the Team returns to the ice to resume play within that time frame, a bench minor penalty for delay of game must be assessed to the offending Team.

Rule 84. Roughing

Roughing is a minor altercation that is not worthy of a major penalty to either participant. (An altercation is a situation involving two players, with at least one to be penalized.

- (a) A minor penalty shall be imposed on a player who strikes an opponent. (See also Rule 56 – Fisticuffs.)
- (b) If, in the judgment of the Referee, a goalkeeper uses his blocking glove to punch an opponent in the head or face in an attempt to or to deliberately injure an opponent, a match penalty must be assessed.

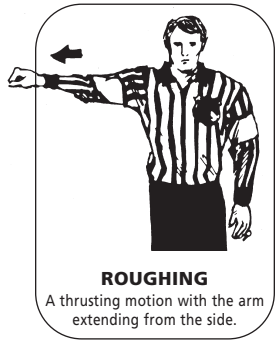

Rule 85. Slashing

Slashing is the act of swinging a player's stick at an opponent, whether contact is made or not.

(NOTE) Non-aggressive stick contact to the pant or front of the shin pads, should not be penalized as slashing.

- (a) A minor or major and a game misconduct penalty, at the discretion of the Referee, shall be imposed on any player who impedes the progress of an opponent by "slashing" with his stick.
- (b) A major and a game misconduct penalty or a match penalty shall be imposed on any player who injures an opponent by slashing. (See Rule 43 – Attempt to or Deliberate Injury of Opponents.)

**SLASHING**

A chopping motion with the edge of one hand across the opposite forearm.

Rule 86. Spearing

Spearing shall mean stabbing an opponent with the point of the stick blade whether contact is made or not.

- (a) A double minor penalty will be imposed on a player who spears an opponent and does not make contact.
- (b) A double minor penalty or, at the discretion of the Referee, a major and a game misconduct shall be imposed on a player who spears an opponent. (See also Rule 43 – Attempt to or Deliberate Injury of Opponents.)
- (c) A match penalty shall be imposed on a player who injures an opponent as a result of a spear. (See also Rule 43 – Attempt to or Deliberate Injury of Opponents.)

**SPEARING**

A jabbing motion with both hands thrust out in front of the body.

Rule 87. Start of Game and Periods

- (a) The game shall be commenced at the time scheduled by a "face-off" in the center of the rink and shall be renewed promptly at the conclusion of each intermission in the same manner.

No delay shall be permitted by reason of any ceremo-

ny, exhibition, demonstration or presentation unless consented to reasonably in advance by the visiting Team.

- (b) Home clubs shall have the choice of goals to defend at the start of the game except where both players' benches are on the same side of the rink, in which case the home club shall start the game defending the goal nearest to its own bench. The Teams shall change ends for each period of regulation time and, in the playoffs, for each period of overtime. (See Rule 89 – NOTE – Tied Games.)
- (c) During the pre-game warm-up (which shall not exceed sixteen (16) minutes in duration) and before the commencement of play in any period, each Team shall confine its activity to its own end of the rink. Refer to Rule 56(g) – Fisticuffs.

(NOTE 1) The Game Timekeeper shall be responsible for signaling the commencement and termination of the pre-game warm-up and any violation of this Rule by the players shall be reported to the President by the Referee, or Supervisor when in attendance at the game.

(NOTE 2) Players shall not be permitted to come on the ice during a stoppage of play or at the end of the first and second periods for the purpose of warming-up. The Referee will report any violation of this Rule to the President for disciplinary action.

- (d) Twenty (20) minutes before the time scheduled for the start of the game, both Teams shall vacate the ice and proceed to their dressing rooms while the ice is being flooded. Both Teams shall be signaled by the Game Timekeeper to return to the ice together in time for the scheduled start of the game.
- (e) At the beginning of the game, if a Team fails to appear on the ice promptly without proper justification, a fine shall be assessed against the offending Team, the amount of the fine to be decided by the President.

At the beginning of the second and third periods, and overtime periods in playoffs (0:00 on the clock), clubs must be on the ice or be observed to be proceeding to the ice. Failure to comply with this regulation will result in a two (2) minute bench minor penalty for delay of game.

- (f) At the end of each period, the visiting Team players must proceed directly to their dressing room while the home Team players must wait for a signal from the Referee to proceed only if they have to go on the ice to reach their dressing room. Failure to comply with this regulation will result in a two (2) minute bench minor for delay of game.

- (g) Before the start of the second and third periods, the Teams will proceed directly to their respective players' benches. Only the starting lineup will be allowed on the ice. The visiting Team will immediately place its starting lineup at the face-off circle, then the home Team will follow. Skating, warm-ups or on-ice activities by non-starters will result in a delay of game penalty to the offending Team.
-

Rule 88. Throwing Stick

- (a) When any member of the defending Team, including any Manager, Coach or Trainer, throws or shoots any part of a stick or any other object at the puck or puck carrier in his defending zone, the Referee shall:
- (i) Award a penalty shot if the stick or other object is thrown or shot at the puck or the puck carrier in the defending zone, preventing a reasonable shot or pass. This shot shall be taken by the player designated by the Referee as the player fouled.
 - (ii) Assess a minor penalty if the stick or other object is thrown or shot at the puck or the puck carrier in the defending zone, but does not interfere in any manner with the puck or the puck carrier.
 - (iii) Not assess a penalty if the stick or other object is thrown or shot away from the area of play (moved out of the traffic area) and in no way interferes with the play.

If, when the opposing goalkeeper has been removed, a member of the defending Team, including any Manager, Coach or Trainer, throws or shoots any part of a stick or any other object at the puck or puck carrier, thereby preventing the puck carrier from having a clear shot on an "open net", a goal shall be awarded to the attacking side.

(NOTE 1) If the Officials are unable to determine the person against whom the offense was made, the offended Team, through the Captain, shall designate a player on the ice at the time the offense was committed to take the shot.

(NOTE 2) For the purpose of this Rule, an "open net" is defined as one from which a goalkeeper has been removed for an additional attacking player.

- (b) A minor penalty shall be imposed on any player on the ice who throws his stick or any part thereof or any other object in the direction of the puck in any zone, except when such act has been penalized by the assessment of a penalty shot or the awarding of a goal.

(NOTE) When the player discards the broken portion of a stick by tossing it to the side of the ice (and not over the boards) in such a

way as will not interfere with play or opposing player, no penalty will be imposed for so doing.

- (c) A misconduct or game misconduct penalty, at the discretion of the Referee, shall be imposed on a player who throws his stick or any part thereof outside the playing area. If the offense is committed in protest of an Official's decision, a minor penalty for unsportsmanlike conduct plus a game misconduct penalty shall be assessed to the offending player.
- (d) If a player attempts to or deliberately injures an opponent by throwing a stick or any other object at an opposing player, Coach, Manager or Trainer, he shall be assessed a match penalty under Rule 43 – Attempt to or Deliberate Injury of Opponents.

Rule 89. Tied Game

- (a) During regular season games, if at the end of the three (3) regular twenty (20) minute periods the score shall be tied, each Team shall be awarded one point in the League standings. The Teams will then play an additional overtime period of not more than five (5) minutes with the Team scoring first declared the winner and being awarded an additional point. The overtime period shall be played with each Team at a numerical strength of four (4) skaters and one (1) goalkeeper

(NOTE 1) The overtime period will be commenced immediately following a one (1) minute rest period during which the players will remain on the ice. The Teams will not change ends for the overtime period.

(NOTE 2) When the regulation time ends and Teams are 5 on 3, Teams will start overtime 5 on 3. Once player strength reaches 5 on 4 or 5 on 5, at the next stoppage of play, player strength is adjusted to 4 on 3 or 4 on 4, as appropriate.

(NOTE 3) When regulation ends and Teams are 4 on 4, Teams will start overtime 3 on 3.

(NOTE 4) At no time will a Team have less than three (3) players on the ice which may require a fifth skater to be added if a two man advantage occurs.

(NOTE 5) A Team shall be allowed to pull its goalkeeper in favor of an additional skater in the overtime period. The goaltender may not return to his position until the next stoppage of play in overtime. Any attempt by the goalkeeper to return to his position prior to the next stoppage of play (on the fly) shall be deemed to be an illegal substitution and a bench minor penalty shall be assessed for having an ineligible player. However, should that Team lose the game during the time in which the goalkeeper has been removed, it would forfeit the automatic point gained in the tie at the end of regulation play, except if the goalkeeper has been removed at the call of a delayed penalty against the other Team.

- (b) During regular season games, if the game remains tied at the end of the five (5) minute overtime period, the Teams will proceed to a shootout following a one (1) minute rest period. The rules governing the shootout shall be the same as those listed under Rule 30 – Penalty Shot.

(NOTE 1) The Teams will not change ends for the shootout. The visiting Team shall shoot first. The Teams shall alternate shots.

NEW

(NOTE 2) Five (5) players from each Team shall participate in the shootout and they shall proceed in such order as the Coach selects. All players are eligible to participate in the shootout unless they are serving a major penalty (their own), a 10 minute misconduct, or have been assessed a game misconduct, gross misconduct or match penalty (their own). Goalkeepers who are assessed penalties prior to the start of the shootout and the penalty imposed cannot be served in its entirety, are permitted to participate in the shootout providing the infraction does not call for immediate ejection.

(NOTE 3) Once the shootout begins, the goalkeeper cannot be replaced unless he is injured. No warm-up shall be permitted for a substitute goalkeeper.

NEW

(NOTE 4) Each Team will be given five (5) shots, unless the outcome is determined earlier in the shootout. After each Team has taken five shots, if the score remains tied, the shootout will proceed to a "sudden death" format. If the score shall remain tied through ten (10) shooters for each Team, the order shall revert back to the first shooter, and proceed in the same order until one Team takes the advantage with an equal number of shooters. The winning Team will be awarded two points, and the losing Team shall be awarded one point in the League standings.

(NOTE 5) Regardless of the number of goals scored during the shootout portion of overtime, the final score recorded for the game will give the winning Team one more goal than its opponent, based on the score at the end of overtime.

(NOTE 6) For League and Club official scoring and goaltending statistics, the following practice will be followed:

- a) Only the winning goal will be recorded (for example, in a 4-1 shootout, the player scoring the second goal for the winning Team will be credited with the winning goal. One extra shot on goal will also be recorded).*
- b) The losing Team will be charged with one extra goal against and one extra shot against, but the losing goalkeeper will not be charged with an extra goal or shot.*
- c) Referee's decision on all shots taken will be final.*

(NOTE 7) No stick measurements will be permitted in a shootout, but will be permitted during overtime in the playoffs. Please also see Rule 19 - Sticks and Rule 19(d) NOTE 3.

During the playoffs at the end of regulation playing time, a regular intermission (15 minutes) shall be taken,

followed by twenty (20) minute "sudden death" periods with regular fifteen (15) minute intermissions between each of the periods, which shall be played until the tie is broken. The ice shall be resurfaced during each intermission unless mutually agreed upon to the contrary.

Rule 90. Time of Match

- (a) The time allowed for a game shall be three (3) twenty (20) minute periods of actual play with a rest intermission between periods.

Play shall be resumed promptly following each intermission upon the expiration of eighteen (18) minutes or a length of time approved by the League from the completion of play in the preceding period. Timing of the intermission commences immediately upon the players and Officials leaving the playing surface. (See Rule 40(b) – Game Timekeeper.) A preliminary warning shall be given by the Game Timekeeper to the Officials and to both Teams five (5) minutes prior to the resumption of play in each period and the final warning shall be given two (2) minutes prior to the resumption of play to enable the Teams to start play promptly.

(NOTE) For the purpose of keeping the spectators informed as to the time remaining during intermissions, the Game Timekeeper will use the electric clock to record length of intermissions.

- (b) The Team scoring the greatest number of goals during the three (3) twenty (20) minute periods shall be the winner and shall be credited with two (2) points in the League standings.
- (c) In the interval between periods, the ice surface shall be flooded unless mutually agreed to the contrary.
- (d) If any unusual delay occurs within five (5) minutes of the end of the first or second periods, the Referee may order the next regular intermission to be taken immediately. The balance of the period will be completed on the resumption of play with the Teams defending the same goals after which, the Teams will change ends and resume play of the ensuing period without delay.

(NOTE) If a delay takes place with more than five (5) minutes remaining in the first or second period, the Referee will order the next regular intermission to be taken immediately only when requested to do so by the home club.

Rule 91. Tripping

(NOTE 1) Accidental trips that occur simultaneously with a completed play will not be penalized.

(NOTE 2) If, in the opinion of the Referee, a player is unquestionably hook-checking the puck and obtains possession of it, thereby

tripping the puck carrier, no penalty shall be imposed.

(NOTE 3) Accidental trips occurring simultaneously with or after a stoppage of play will not be penalized.

(NOTE 4) "Slew-Footing" is the act of a player using his leg or foot to knock or kick an opponent's feet from under him, or pushes an opponent's upper body backward with an arm or elbow, and at the same time with a forward motion of his leg, knocks or kicks the opponent's feet from under him.

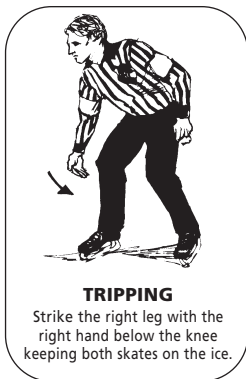

- (a) A minor penalty shall be imposed on any player who shall place his stick or any portion of his body in such a manner that it shall cause his opponent to trip and fall.
- (b) When a player, in control of the puck (or who could have obtained possession and control of the puck) on the opponent's side of the center red line and having no other opponent to pass than the goalkeeper, is tripped or otherwise fouled from behind, thus preventing a reasonable scoring opportunity, a penalty shot shall be awarded to the non-offending side. Nevertheless, the Referee shall not stop play until the attacking side has lost possession of the puck to the defending side.

(NOTE 5) The intent of this Rule is to restore a reasonable scoring opportunity that has been lost by reason of a foul from behind when the foul is committed on the opponent's side of the red line.

"Control of the puck" means the act of propelling the puck with the stick, hand or feet. If while it is being propelled, the puck is touched by another player or his equipment, or hits the goal or goes free, the player shall no longer be considered to be "in control of the puck".

In order for a penalty shot to be awarded for a player being fouled from behind, the following four criteria must have been met:

- (i) The infraction must have taken place in the opponent's half of the ice, i.e. over the center red line;
- (ii) The infraction must have been committed from behind;
- (iii) The player in possession and control (or, in the judgment of the Referee, the player clearly would have obtained possession and control of the puck) must have been denied a reasonable chance to score.

(NOTE) *The fact that he got a shot off does not automatically eliminate this play from the penalty shot consideration criteria. If the foul was from behind and he was denied a "more" reasonable scoring opportunity due to the foul, then the penalty shot should be awarded), and;*

- (iv) The player in possession and control (or, in the judgment of the Referee, the player clearly would have obtained possession and control) must have had no opposing player between himself and the goalkeeper.
- (c) If, when the opposing goaltender has been removed from the ice, a player in control of the puck is tripped or otherwise fouled with no opposition between him and the opposing goal, thus preventing a reasonable scoring opportunity, the Referee shall immediately stop play and award a goal to the attacking Team.
- (d) Any player who is guilty of "slew-footing" shall be assessed a match penalty. This penalty shall be in accordance with Rule 43 – Attempt to or Deliberate Injury of Opponents. Any player assessed a match penalty for "slew-footing" will also be subject to Rule 33A – Supplementary Discipline.

Rule 92. Time-Outs

- (a) Each Team shall be permitted to take one (1) thirty-second (:30) time-out during the course of any game, regular-season or playoffs.
- (b) This time-out must be taken during a normal stoppage of play. Only one time-out, commercial or Team, shall be permitted at any one stoppage of play.

(NOTE) *For the purpose of this Rule, a commercial stoppage in play is deemed to be an "official time-out" and not charged to either Team.*

- (c) Any player designated by the Coach will indicate to the Referee (prior to the drop of the puck) that his Team is exercising its option and the Referee will report the time-out to the Game Timekeeper who shall be responsible for signaling the termination of the time-out.
- (d) No time-out shall be granted following a face-off violation.
- (e) When a penalty shot has been awarded to either Team by the Referee, no time-out will be granted once instructions have been given to the player taking the shot and the goalkeeper defending the shot. No time-out will be granted during the shoot-out.

NEW



CHL SCHEDULE 2005-06

All Games and Times Subject to Change

All Start Times Local

#	DAY	DATE	VISITOR	HOME	START TIME
1	Fri.	Oct. 21/05	Memphis	Bossier-Shreveport	7:05 PM
2	Fri.	Oct. 21/05	Laredo	Colorado	7:05 PM
3	Fri.	Oct. 21/05	Odessa	Wichita	7:05 PM
4	Fri.	Oct. 21/05	Corpus Christi	Austin	7:30 PM
5	Fri.	Oct. 21/05	Fort Worth	Oklahoma City	7:35 PM
6	Fri.	Oct. 21/05	Lubbock	Rio Grande Valley	7:35 PM
7	Fri.	Oct. 21/05	Youngstown	Tulsa	7:35 PM
8	Sat.	Oct. 22/05	Laredo	Amarillo	7:00 PM
9	Sat.	Oct. 22/05	Youngstown	Bossier-Shreveport	7:05 PM
10	Sat.	Oct. 22/05	Odessa	Colorado	7:05 PM
11	Sat.	Oct. 22/05	Oklahoma City	Wichita	7:05 PM
12	Sat.	Oct. 22/05	Tulsa	Fort Worth	7:30 PM
13	Sat.	Oct. 22/05	Austin	Corpus Christi	7:35 PM
14	Sat.	Oct. 22/05	Lubbock	Rio Grande Valley	7:35 PM
15	Tue.	Oct. 25/05	Bossier-Shreveport	Fort Worth	7:30 PM
16	Fri.	Oct. 28/05	Lubbock	Odessa	7:00 PM
17	Fri.	Oct. 28/05	Austin	Bossier-Shreveport	7:05 PM
18	Fri.	Oct. 28/05	Youngstown	Memphis	7:05 PM
19	Fri.	Oct. 28/05	Colorado	Wichita	7:05 PM
20	Fri.	Oct. 28/05	Laredo	Fort Worth	7:30 PM
21	Fri.	Oct. 28/05	Rio Grande Valley	Oklahoma City	7:35 PM
22	Fri.	Oct. 28/05	Amarillo	Tulsa	7:35 PM
23	Sat.	Oct. 29/05	Oklahoma City	Odessa	7:00 PM
24	Sat.	Oct. 29/05	Wichita	Colorado	7:05 PM
25	Sat.	Oct. 29/05	Amarillo	Lubbock	7:05 PM
26	Sat.	Oct. 29/05	Bossier-Shreveport	Memphis	7:05 PM
27	Sat.	Oct. 29/05	Rio Grande Valley	Austin	7:30 PM
28	Sat.	Oct. 29/05	Youngstown	Fort Worth	7:30 PM
29	Sat.	Oct. 29/05	Corpus Christi	Laredo	7:30 PM
30	Sun.	Oct. 30/05	Lubbock	Austin	4:00 PM
31	Sun.	Oct. 30/05	Youngstown	Corpus Christi	5:05 PM
32	Sun.	Oct. 30/05	Odessa	Amarillo	6:00 PM
33	Sun.	Oct. 30/05	Laredo	Rio Grande Valley	6:05 PM
34	Wed.	Nov. 2/05	Bossier-Shreveport	Colorado	7:05 PM
35	Thu.	Nov. 3/05	Memphis	Corpus Christi	7:35 PM
36	Fri.	Nov. 4/05	Bossier-Shreveport	Colorado	7:05 PM
37	Fri.	Nov. 4/05	Amarillo	Wichita	7:05 PM

#	DAY	DATE	VISITOR	HOME	START TIME
38	Fri.	Nov. 4/05	Oklahoma City	Youngstown	7:05 PM
39	Fri.	Nov. 4/05	Fort Worth	Austin	7:30 PM
40	Fri.	Nov. 4/05	Laredo	Rio Grande Valley	7:35 PM
41	Fri.	Nov. 4/05	Lubbock	Tulsa	7:35 PM
42	Sat.	Nov. 5/05	Lubbock	Amarillo	7:00 PM
43	Sat.	Nov. 5/05	Bossier-Shreveport	Wichita	7:05 PM
44	Sat.	Nov. 5/05	Oklahoma City	Youngstown	7:05 PM
45	Sat.	Nov. 5/05	Tulsa	Austin	7:30 PM
46	Sat.	Nov. 5/05	Memphis	Laredo	7:30 PM
47	Sat.	Nov. 5/05	Fort Worth	Corpus Christi	7:35 PM
48	Sat.	Nov. 5/05	Odessa	Rio Grande Valley	7:35 PM
49	Sun.	Nov. 6/05	Austin	Lubbock	5:05 PM
50	Sun.	Nov. 6/05	Tulsa	Amarillo	6:00 PM
51	Tue.	Nov. 8/05	Odessa	Lubbock	11:00 AM
52	Wed.	Nov. 9/05	Oklahoma City	Wichita	7:05 PM
53	Thu.	Nov. 10/05	Corpus Christi	Memphis	7:05 PM
54	Thu.	Nov. 10/05	Laredo	Austin	7:30 PM
55	Fri.	Nov. 11/05	Lubbock	Odessa	7:00 PM
56	Fri.	Nov. 11/05	Bossier-Shreveport	Memphis	7:05 PM
57	Fri.	Nov. 11/05	Tulsa	Youngstown	7:05 PM
58	Fri.	Nov. 11/05	Corpus Christi	Fort Worth	7:30 PM
59	Fri.	Nov. 11/05	Amarillo	Laredo	7:30 PM
60	Fri.	Nov. 11/05	Wichita	Oklahoma City	7:35 PM
61	Fri.	Nov. 11/05	Colorado	Rio Grande Valley	7:35 PM
62	Sat.	Nov. 12/05	Wichita	Odessa	7:00 PM
63	Sat.	Nov. 12/05	Oklahoma City	Lubbock	7:05 PM
64	Sat.	Nov. 12/05	Tulsa	Youngstown	7:05 PM
65	Sat.	Nov. 12/05	Bossier-Shreveport	Fort Worth	7:30 PM
66	Sat.	Nov. 12/05	Colorado	Laredo	7:30 PM
67	Sat.	Nov. 12/05	Amarillo	Corpus Christi	7:35 PM
68	Sat.	Nov. 12/05	Austin	Rio Grande Valley	7:35 PM
69	Sun.	Nov. 13/05	Odessa	Austin	4:00 PM
70	Sun.	Nov. 13/05	Memphis	Wichita	5:05 PM
71	Tue.	Nov. 15/05	Bossier-Shreveport	Memphis	10:00 AM
72	Tue.	Nov. 15/05	Rio Grande Valley	Corpus Christi	11:05 AM
73	Tue.	Nov. 15/05	Amarillo	Tulsa	7:00 PM
74	Tue.	Nov. 15/05	Laredo	Youngstown	7:05 PM
75	Tue.	Nov. 15/05	Oklahoma City	Fort Worth	7:30 PM
76	Wed.	Nov. 16/05	Wichita	Colorado	7:05 PM
77	Wed.	Nov. 16/05	Laredo	Youngstown	7:05 PM
78	Thu.	Nov. 17/05	Lubbock	Odessa	11:00 AM
79	Thu.	Nov. 17/05	Fort Worth	Memphis	7:05 PM
80	Fri.	Nov. 18/05	Amarillo	Odessa	7:00 PM
81	Fri.	Nov. 18/05	Tulsa	Colorado	7:05 PM
82	Fri.	Nov. 18/05	Youngstown	Lubbock	7:05 PM
83	Fri.	Nov. 18/05	Fort Worth	Memphis	7:05 PM
84	Fri.	Nov. 18/05	Bossier-Shreveport	Wichita	7:05 PM
85	Fri.	Nov. 18/05	Rio Grande Valley	Austin	7:30 PM

CENTRAL HOCKEY LEAGUE

<u>#</u>	<u>DAY</u>	<u>DATE</u>	<u>VISITOR</u>	<u>HOME</u>	<u>START TIME</u>
86	Fri.	Nov. 18/05	Corpus Christi	Oklahoma City	7:35 PM
87	Sat.	Nov. 19/05	Lubbock	Amarillo	7:00 PM
88	Sat.	Nov. 19/05	Memphis	Bossier-Shreveport	7:05 PM
89	Sat.	Nov. 19/05	Tulsa	Colorado	7:05 PM
90	Sat.	Nov. 19/05	Oklahoma City	Wichita	7:05 PM
91	Sat.	Nov. 19/05	Corpus Christi	Austin	7:30 PM
92	Sat.	Nov. 19/05	Laredo	Rio Grande Valley	7:35 PM
93	Sun.	Nov. 20/05	Youngstown	Oklahoma City	3:00 PM
94	Sun.	Nov. 20/05	Rio Grande Valley	Laredo	4:00 PM
95	Sun.	Nov. 20/05	Odessa	Corpus Christi	5:05 PM
96	Tue.	Nov. 22/05	Youngstown	Bossier-Shreveport	7:05 PM
97	Tue.	Nov. 22/05	Colorado	Fort Worth	7:30 PM
98	Wed.	Nov. 23/05	Laredo	Lubbock	7:05 PM
99	Wed.	Nov. 23/05	Colorado	Oklahoma City	7:05 PM
100	Wed.	Nov. 23/05	Tulsa	Wichita	7:05 PM
101	Fri.	Nov. 25/05	Austin	Amarillo	7:00 PM
102	Fri.	Nov. 25/05	Fort Worth	Bossier-Shreveport	7:05 PM
103	Fri.	Nov. 25/05	Memphis	Lubbock	7:05 PM
104	Fri.	Nov. 25/05	Corpus Christi	Youngstown	7:05 PM
105	Fri.	Nov. 25/05	Odessa	Laredo	7:30 PM
106	Fri.	Nov. 25/05	Tulsa	Oklahoma City	7:35 PM
107	Fri.	Nov. 25/05	Wichita	Rio Grande Valley	7:35 PM
108	Sat.	Nov. 26/05	Lubbock	Amarillo	7:00 PM
109	Sat.	Nov. 26/05	Colorado	Bossier-Shreveport	7:05 PM
110	Sat.	Nov. 26/05	Corpus Christi	Youngstown	7:05 PM
111	Sat.	Nov. 26/05	Memphis	Austin	7:30 PM
112	Sat.	Nov. 26/05	Oklahoma City	Fort Worth	7:30 PM
113	Sat.	Nov. 26/05	Wichita	Laredo	7:30 PM
114	Sat.	Nov. 26/05	Odessa	Rio Grande Valley	7:35 PM
115	Sun.	Nov. 27/05	Colorado	Tulsa	2:00 PM
116	Tue.	Nov. 29/05	Colorado	Fort Worth	7:30 PM
117	Wed.	Nov. 30/05	Rio Grande Valley	Laredo	7:00 PM
118	Thu.	Dec. 1/05	Amarillo	Odessa	7:00 PM
119	Thu.	Dec. 1/05	Austin	Corpus Christi	7:35 PM
120	Fri.	Dec. 2/05	Laredo	Odessa	7:00 PM
121	Fri.	Dec. 2/05	Memphis	Colorado	7:05 PM
122	Fri.	Dec. 2/05	Lubbock	Youngstown	7:05 PM
123	Fri.	Dec. 2/05	Corpus Christi	Austin	7:30 PM
124	Fri.	Dec. 2/05	Bossier-Shreveport	Fort Worth	7:30 PM
125	Fri.	Dec. 2/05	Amarillo	Oklahoma City	7:35 PM
126	Fri.	Dec. 2/05	Wichita	Tulsa	7:35 PM
127	Sat.	Dec. 3/05	Memphis	Colorado	7:05 PM
128	Sat.	Dec. 3/05	Tulsa	Wichita	7:05 PM
129	Sat.	Dec. 3/05	Lubbock	Youngstown	7:05 PM
130	Sat.	Dec. 3/05	Oklahoma City	Fort Worth	7:30 PM
131	Sat.	Dec. 3/05	Bossier-Shreveport	Laredo	7:30 PM
132	Sat.	Dec. 3/05	Odessa	Corpus Christi	7:35 PM
133	Sat.	Dec. 3/05	Austin	Rio Grande Valley	7:35 PM

#	DAY	DATE	VISITOR	HOME	START TIME
134	Sun.	Dec. 4/05	Amarillo	Fort Worth	3:00 PM
135	Tue.	Dec. 6/05	Lubbock	Odessa	7:00 PM
136	Tue.	Dec. 6/05	Colorado	Tulsa	7:00 PM
137	Tue.	Dec. 6/05	Rio Grande Valley	Youngstown	7:05 PM
138	Wed.	Dec. 7/05	Rio Grande Valley	Youngstown	7:05 PM
139	Wed.	Dec. 7/05	Austin	Fort Worth	7:30 PM
140	Thu.	Dec. 8/05	Colorado	Bossier-Shreveport	7:05 PM
141	Fri.	Dec. 9/05	Youngstown	Amarillo	7:00 PM
142	Fri.	Dec. 9/05	Corpus Christi	Odessa	7:00 PM
143	Fri.	Dec. 9/05	Laredo	Lubbock	7:05 PM
144	Fri.	Dec. 9/05	Colorado	Memphis	7:05 PM
145	Fri.	Dec. 9/05	Tulsa	Wichita	7:05 PM
146	Fri.	Dec. 9/05	Bossier-Shreveport	Austin	7:30 PM
147	Fri.	Dec. 9/05	Fort Worth	Oklahoma City	7:35 PM
148	Sat.	Dec. 10/05	Youngstown	Odessa	7:00 PM
149	Sat.	Dec. 10/05	Colorado	Memphis	7:05 PM
150	Sat.	Dec. 10/05	Fort Worth	Wichita	7:05 PM
151	Sat.	Dec. 10/05	Rio Grande Valley	Austin	7:30 PM
152	Sat.	Dec. 10/05	Lubbock	Laredo	7:30 PM
153	Sat.	Dec. 10/05	Bossier-Shreveport	Corpus Christi	7:35 PM
154	Sat.	Dec. 10/05	Tulsa	Oklahoma City	7:35 PM
155	Sun.	Dec. 11/05	Oklahoma City	Tulsa	2:00 PM
156	Sun.	Dec. 11/05	Lubbock	Corpus Christi	5:05 PM
157	Sun.	Dec. 11/05	Odessa	Amarillo	6:00 PM
158	Sun.	Dec. 11/05	Laredo	Rio Grande Valley	6:05 PM
159	Tue.	Dec. 13/05	Memphis	Wichita	7:05 PM
160	Tue.	Dec. 13/05	Youngstown	Fort Worth	10:30 AM
161	Wed.	Dec. 14/05	Oklahoma City	Colorado	7:05 PM
162	Thu.	Dec. 15/05	Austin	Corpus Christi	7:35 PM
163	Fri.	Dec. 16/05	Odessa	Amarillo	7:00 PM
164	Fri.	Dec. 16/05	Fort Worth	Bossier-Shreveport	7:05 PM
165	Fri.	Dec. 16/05	Youngstown	Colorado	7:05 PM
166	Fri.	Dec. 16/05	Austin	Laredo	7:30 PM
167	Fri.	Dec. 16/05	Wichita	Oklahoma City	7:35 PM
168	Fri.	Dec. 16/05	Corpus Christi	Rio Grande Valley	7:35 PM
169	Fri.	Dec. 16/05	Memphis	Tulsa	7:35 PM
170	Sat.	Dec. 17/05	Colorado	Amarillo	7:00 PM
171	Sat.	Dec. 17/05	Fort Worth	Bossier-Shreveport	7:05 PM
172	Sat.	Dec. 17/05	Odessa	Lubbock	7:05 PM
173	Sat.	Dec. 17/05	Corpus Christi	Austin	7:30 PM
174	Sat.	Dec. 17/05	Rio Grande Valley	Laredo	7:30 PM
175	Sat.	Dec. 17/05	Memphis	Oklahoma City	7:35 PM
176	Sat.	Dec. 17/05	Wichita	Tulsa	7:35 PM
177	Sun.	Dec. 18/05	Laredo	Rio Grande Valley	6:05 PM
178	Tue.	Dec. 20/05	Corpus Christi	Amarillo	7:00 PM
179	Tue.	Dec. 20/05	Austin	Memphis	7:05 PM
180	Wed.	Dec. 21/05	Lubbock	Odessa	7:00 PM
181	Wed.	Dec. 21/05	Tulsa	Colorado	7:05 PM

CENTRAL HOCKEY LEAGUE

<u>#</u>	<u>DAY</u>	<u>DATE</u>	<u>VISITOR</u>	<u>HOME</u>	<u>START TIME</u>
182	Wed.	Dec. 21/05	Austin	Fort Worth	7:30 PM
183	Thu.	Dec. 22/05	Wichita	Bossier-Shreveport	7:05 PM
184	Thu.	Dec. 22/05	Amarillo	Youngstown	7:05 PM
185	Fri.	Dec. 23/05	Tulsa	Colorado	7:05 PM
186	Fri.	Dec. 23/05	Odessa	Lubbock	7:05 PM
187	Fri.	Dec. 23/05	Bossier-Shreveport	Memphis	7:05 PM
188	Fri.	Dec. 23/05	Fort Worth	Wichita	7:05 PM
189	Fri.	Dec. 23/05	Amarillo	Youngstown	7:05 PM
190	Fri.	Dec. 23/05	Austin	Laredo	7:30 PM
191	Fri.	Dec. 23/05	Rio Grande Valley	Corpus Christi	7:35 PM
192	Sun.	Dec. 25/05	Tulsa	Oklahoma City	7:35 PM
193	Tue.	Dec. 27/05	Fort Worth	Tulsa	7:00 PM
194	Tue.	Dec. 27/05	Youngstown	Memphis	7:05 PM
195	Tue.	Dec. 27/05	Oklahoma City	Wichita	7:05 PM
196	Tue.	Dec. 27/05	Laredo	Rio Grande Valley	7:35 PM
197	Wed.	Dec. 28/05	Corpus Christi	Laredo	7:00 PM
198	Wed.	Dec. 28/05	Lubbock	Austin	7:30 PM
199	Wed.	Dec. 28/05	Colorado	Fort Worth	7:30 PM
200	Thu.	Dec. 29/05	Amarillo	Odessa	7:00 PM
201	Thu.	Dec. 29/05	Oklahoma City	Bossier-Shreveport	7:05 PM
202	Thu.	Dec. 29/05	Youngstown	Wichita	7:05 PM
203	Fri.	Dec. 30/05	Wichita	Amarillo	7:00 PM
204	Fri.	Dec. 30/05	Austin	Odessa	7:00 PM
205	Fri.	Dec. 30/05	Youngstown	Colorado	7:05 PM
206	Fri.	Dec. 30/05	Corpus Christi	Lubbock	7:05 PM
207	Fri.	Dec. 30/05	Rio Grande Valley	Fort Worth	7:30 PM
208	Fri.	Dec. 30/05	Bossier-Shreveport	Oklahoma City	7:35 PM
209	Fri.	Dec. 30/05	Memphis	Tulsa	7:35 PM
210	Sat.	Dec. 31/05	Bossier-Shreveport	Lubbock	5:05 PM
211	Sat.	Dec. 31/05	Colorado	Amarillo	7:00 PM
212	Sat.	Dec. 31/05	Tulsa	Memphis	7:05 PM
213	Sat.	Dec. 31/05	Austin	Laredo	7:30 PM
214	Sat.	Dec. 31/05	Wichita	Oklahoma City	7:35 PM
215	Sat.	Dec. 31/05	Fort Worth	Rio Grande Valley	7:35 PM
216	Sat.	Dec. 31/05	Odessa	Corpus Christi	8:05 PM
217	Tue.	Jan. 3/06	Youngstown	Bossier-Shreveport	7:05 PM
218	Tue.	Jan. 3/06	Memphis	Fort Worth	7:30 PM
219	Wed.	Jan. 4/06	Tulsa	Colorado	7:05 PM
220	Thu.	Jan. 5/06	Wichita	Oklahoma City	7:05 PM
221	Fri.	Jan. 6/06	Amarillo	Colorado	7:05 PM
222	Fri.	Jan. 6/06	Odessa	Lubbock	7:05 PM
223	Fri.	Jan. 6/06	Oklahoma City	Memphis	7:05 PM
224	Fri.	Jan. 6/06	Bossier-Shreveport	Wichita	7:05 PM
225	Fri.	Jan. 6/06	Youngstown	Laredo	7:30 PM
226	Fri.	Jan. 6/06	Fort Worth	Corpus Christi	7:35 PM
227	Fri.	Jan. 6/06	Austin	Rio Grande Valley	7:35 PM
228	Sat.	Jan. 7/06	Lubbock	Colorado	7:05 PM
229	Sat.	Jan. 7/06	Bossier-Shreveport	Memphis	7:05 PM

#	DAY	DATE	VISITOR	HOME	START TIME
230	Sat.	Jan. 7/06	Laredo	Austin	7:30 PM
231	Sat.	Jan. 7/06	Youngstown	Fort Worth	7:30 PM
232	Sat.	Jan. 7/06	Odessa	Oklahoma City	7:35 PM
233	Sat.	Jan. 7/06	Corpus Christi	Rio Grande Valley	7:35 PM
234	Sat.	Jan. 7/06	Wichita	Tulsa	7:35 PM
235	Sun.	Jan. 8/06	Rio Grande Valley	Austin	4:00 PM
236	Sun.	Jan. 8/06	Laredo	Corpus Christi	5:05 PM
237	Sun.	Jan. 8/06	Odessa	Amarillo	6:00 PM
238	Tue.	Jan. 10/06	Fort Worth	Memphis	7:05 PM
239	Tue.	Jan. 10/06	Tulsa	Oklahoma City	7:05 PM
240	Wed.	Jan. 11/06	Austin	Laredo	7:00 PM
241	Wed.	Jan. 11/06	Amarillo	Lubbock	7:05 PM
242	Wed.	Jan. 11/06	Wichita	Youngstown	7:05 PM
243	Thu.	Jan. 12/06	Corpus Christi	Rio Grande Valley	7:35 PM
244	Fri.	Jan. 13/06	Colorado	Amarillo	7:00 PM
245	Fri.	Jan. 13/06	Laredo	Bossier-Shreveport	7:05 PM
246	Fri.	Jan. 13/06	Oklahoma City	Memphis	7:05 PM
247	Fri.	Jan. 13/06	Wichita	Youngstown	7:05 PM
248	Fri.	Jan. 13/06	Fort Worth	Austin	7:30 PM
249	Fri.	Jan. 13/06	Rio Grande Valley	Corpus Christi	7:35 PM
250	Fri.	Jan. 13/06	Odessa	Tulsa	7:35 PM
251	Sat.	Jan. 14/06	Odessa	Amarillo	7:00 PM
252	Sat.	Jan. 14/06	Fort Worth	Bossier-Shreveport	7:05 PM
253	Sat.	Jan. 14/06	Colorado	Lubbock	7:05 PM
254	Sat.	Jan. 14/06	Laredo	Memphis	7:05 PM
255	Sat.	Jan. 14/06	Wichita	Youngstown	7:05 PM
256	Sat.	Jan. 14/06	Rio Grande Valley	Austin	7:30 PM
257	Sat.	Jan. 14/06	Oklahoma City	Tulsa	7:35 PM
258	Sun.	Jan. 15/06	Colorado	Oklahoma City	3:00 PM
259	Sun.	Jan. 15/06	Corpus Christi	Lubbock	5:05 PM
260	Fri.	Jan. 20/06	Austin	Amarillo	7:00 PM
261	Fri.	Jan. 20/06	Oklahoma City	Bossier-Shreveport	7:05 PM
262	Fri.	Jan. 20/06	Tulsa	Memphis	7:05 PM
263	Fri.	Jan. 20/06	Odessa	Youngstown	7:05 PM
264	Fri.	Jan. 20/06	Colorado	Laredo	7:30 PM
265	Fri.	Jan. 20/06	Wichita	Corpus Christi	7:35 PM
266	Fri.	Jan. 20/06	Fort Worth	Rio Grande Valley	7:35 PM
267	Sat.	Jan. 21/06	Lubbock	Amarillo	7:00 PM
268	Sat.	Jan. 21/06	Memphis	Bossier-Shreveport	7:05 PM
269	Sat.	Jan. 21/06	Odessa	Youngstown	7:05 PM
270	Sat.	Jan. 21/06	Wichita	Austin	7:30 PM
271	Sat.	Jan. 21/06	Fort Worth	Laredo	7:30 PM
272	Sat.	Jan. 21/06	Colorado	Corpus Christi	7:35 PM
273	Sat.	Jan. 21/06	Tulsa	Oklahoma City	7:35 PM
274	Sun.	Jan. 22/06	Oklahoma City	Tulsa	2:00 PM
275	Sun.	Jan. 22/06	Amarillo	Lubbock	5:05 PM
276	Sun.	Jan. 22/06	Rio Grande Valley	Memphis	7:05 PM
277	Mon.	Jan. 23/06	Corpus Christi	Austin	11:30 AM

CENTRAL HOCKEY LEAGUE

<u>#</u>	<u>DAY</u>	<u>DATE</u>	<u>VISITOR</u>	<u>HOME</u>	<u>START TIME</u>
278	Tue.	Jan. 24/06	Rio Grande Valley	Bossier-Shreveport	7:05 PM
279	Wed.	Jan. 25/06	Amarillo	Colorado	7:05 PM
280	Thu.	Jan. 26/06	Austin	Corpus Christi	7:35 PM
281	Fri.	Jan. 27/06	Wichita	Amarillo	7:00 PM
282	Fri.	Jan. 27/06	Bossier-Shreveport	Odessa	7:00 PM
283	Fri.	Jan. 27/06	Rio Grande Valley	Colorado	7:05 PM
284	Fri.	Jan. 27/06	Oklahoma City	Lubbock	7:05 PM
285	Fri.	Jan. 27/06	Fort Worth	Austin	7:30 PM
286	Fri.	Jan. 27/06	Corpus Christi	Laredo	7:30 PM
287	Fri.	Jan. 27/06	Memphis	Tulsa	7:35 PM
288	Sat.	Jan. 28/06	Lubbock	Odessa	7:00 PM
289	Sat.	Jan. 28/06	Fort Worth	Bossier-Shreveport	7:05 PM
290	Sat.	Jan. 28/06	Rio Grande Valley	Colorado	7:05 PM
291	Sat.	Jan. 28/06	Memphis	Wichita	7:05 PM
292	Sat.	Jan. 28/06	Oklahoma City	Austin	7:30 PM
293	Sat.	Jan. 28/06	Laredo	Corpus Christi	7:35 PM
294	Sat.	Jan. 28/06	Youngstown	Tulsa	7:35 PM
295	Sun.	Jan. 29/06	Oklahoma City	Laredo	4:00 PM
296	Sun.	Jan. 29/06	Memphis	Bossier-Shreveport	5:05 PM
297	Sun.	Jan. 29/06	Odessa	Lubbock	5:05 PM
298	Sun.	Jan. 29/06	Youngstown	Wichita	5:05 PM
299	Sun.	Jan. 29/06	Tulsa	Amarillo	6:00 PM
300	Tue.	Jan. 31/06	Bossier-Shreveport	Rio Grande Valley	11:00 AM
301	Tue.	Jan. 31/06	Amarillo	Odessa	7:00 PM
302	Tue.	Jan. 31/06	Corpus Christi	Tulsa	7:00 PM
303	Wed.	Feb. 1/06	Memphis	Youngstown	11:00 AM
304	Thu.	Feb. 2/06	Colorado	Oklahoma City	7:05 PM
305	Fri.	Feb. 3/06	Tulsa	Odessa	7:00 PM
306	Fri.	Feb. 3/06	Amarillo	Lubbock	7:05 PM
307	Fri.	Feb. 3/06	Memphis	Youngstown	7:05 PM
308	Fri.	Feb. 3/06	Fort Worth	Austin	7:30 PM
309	Fri.	Feb. 3/06	Rio Grande Valley	Laredo	7:30 PM
310	Fri.	Feb. 3/06	Bossier-Shreveport	Corpus Christi	7:35 PM
311	Fri.	Feb. 3/06	Colorado	Oklahoma City	7:35 PM
312	Sat.	Feb. 4/06	Lubbock	Amarillo	7:00 PM
313	Sat.	Feb. 4/06	Austin	Odessa	7:00 PM
314	Sat.	Feb. 4/06	Colorado	Wichita	7:05 PM
315	Sat.	Feb. 4/06	Memphis	Youngstown	7:05 PM
316	Sat.	Feb. 4/06	Bossier-Shreveport	Fort Worth	7:30 PM
317	Sat.	Feb. 4/06	Rio Grande Valley	Laredo	7:30 PM
318	Sat.	Feb. 4/06	Oklahoma City	Tulsa	7:35 PM
319	Tue.	Feb. 7/06	Youngstown	Tulsa	7:00 PM
320	Tue.	Feb. 7/06	Corpus Christi	Bossier-Shreveport	7:05 PM
321	Tue.	Feb. 7/06	Lubbock	Oklahoma City	7:05 PM
322	Tue.	Feb. 7/06	Odessa	Fort Worth	7:30 PM
323	Wed.	Feb. 8/06	Rio Grande Valley	Laredo	7:00 PM
324	Wed.	Feb. 8/06	Wichita	Colorado	7:05 PM
325	Wed.	Feb. 8/06	Memphis	Austin	7:30 PM

#	DAY	DATE	VISITOR	HOME	START TIME
326	Thu.	Feb. 9/06	Amarillo	Corpus Christi	7:35 PM
327	Fri.	Feb. 10/06	Odessa	Bossier-Shreveport	7:05 PM
328	Fri.	Feb. 10/06	Tulsa	Lubbock	7:05 PM
329	Fri.	Feb. 10/06	Youngstown	Memphis	7:05 PM
330	Fri.	Feb. 10/06	Colorado	Wichita	7:05 PM
331	Fri.	Feb. 10/06	Laredo	Fort Worth	7:30 PM
332	Fri.	Feb. 10/06	Austin	Oklahoma City	7:35 PM
333	Fri.	Feb. 10/06	Amarillo	Rio Grande Valley	7:35 PM
334	Sat.	Feb. 11/06	Laredo	Bossier-Shreveport	7:05 PM
335	Sat.	Feb. 11/06	Lubbock	Colorado	7:05 PM
336	Sat.	Feb. 11/06	Odessa	Memphis	7:05 PM
337	Sat.	Feb. 11/06	Tulsa	Wichita	7:05 PM
338	Sat.	Feb. 11/06	Amarillo	Austin	7:30 PM
339	Sat.	Feb. 11/06	Corpus Christi	Fort Worth	7:30 PM
340	Sat.	Feb. 11/06	Youngstown	Oklahoma City	7:35 PM
341	Sun.	Feb. 12/06	Youngstown	Austin	4:00 PM
342	Sun.	Feb. 12/06	Corpus Christi	Rio Grande Valley	6:05 PM
343	Tue.	Feb. 14/06	Tulsa	Amarillo	7:00 PM
344	Tue.	Feb. 14/06	Corpus Christi	Laredo	7:00 PM
345	Tue.	Feb. 14/06	Youngstown	Bossier-Shreveport	7:05 PM
346	Wed.	Feb. 15/06	Rio Grande Valley	Oklahoma City	10:35 AM
347	Thu.	Feb. 16/06	Bossier-Shreveport	Lubbock	7:05 PM
348	Thu.	Feb. 16/06	Wichita	Memphis	7:05 PM
349	Fri.	Feb. 17/06	Bossier-Shreveport	Amarillo	7:00 PM
350	Fri.	Feb. 17/06	Laredo	Odessa	7:00 PM
351	Fri.	Feb. 17/06	Colorado	Austin	7:30 PM
352	Fri.	Feb. 17/06	Youngstown	Fort Worth	7:30 PM
353	Fri.	Feb. 17/06	Memphis	Oklahoma City	7:35 PM
354	Fri.	Feb. 17/06	Corpus Christi	Rio Grande Valley	7:35 PM
355	Fri.	Feb. 17/06	Wichita	Tulsa	7:35 PM
356	Sat.	Feb. 18/06	Laredo	Amarillo	7:00 PM
357	Sat.	Feb. 18/06	Fort Worth	Odessa	7:00 PM
358	Sat.	Feb. 18/06	Colorado	Lubbock	7:05 PM
359	Sat.	Feb. 18/06	Austin	Corpus Christi	7:35 PM
360	Sat.	Feb. 18/06	Wichita	Oklahoma City	7:35 PM
361	Sat.	Feb. 18/06	Youngstown	Rio Grande Valley	7:35 PM
362	Sat.	Feb. 18/06	Memphis	Tulsa	7:35 PM
363	Sun.	Feb. 19/06	Laredo	Austin	4:00 PM
364	Sun.	Feb. 19/06	Lubbock	Bossier-Shreveport	5:05 PM
365	Mon.	Feb. 20/06	Youngstown	Fort Worth	6:00 PM
366	Tue.	Feb. 21/06	Rio Grande Valley	Odessa	7:00 PM
367	Tue.	Feb. 21/06	Oklahoma City	Tulsa	7:00 PM
368	Tue.	Feb. 21/06	Lubbock	Memphis	7:05 PM
369	Wed.	Feb. 22/06	Amarillo	Colorado	7:05 PM
370	Wed.	Feb. 22/06	Fort Worth	Wichita	7:05 PM
371	Wed.	Feb. 22/06	Bossier-Shreveport	Youngstown	7:05 PM
372	Thu.	Feb. 23/06	Tulsa	Lubbock	7:05 PM
373	Fri.	Feb. 24/06	Amarillo	Odessa	7:00 PM

CENTRAL HOCKEY LEAGUE

<u>#</u>	<u>DAY</u>	<u>DATE</u>	<u>VISITOR</u>	<u>HOME</u>	<u>START TIME</u>
374	Fri.	Feb. 24/06	Oklahoma City	Colorado	7:05 PM
375	Fri.	Feb. 24/06	Bossier-Shreveport	Youngstown	7:05 PM
376	Fri.	Feb. 24/06	Memphis	Fort Worth	7:30 PM
377	Fri.	Feb. 24/06	Corpus Christi	Laredo	7:30 PM
378	Fri.	Feb. 24/06	Austin	Rio Grande Valley	7:35 PM
379	Fri.	Feb. 24/06	Wichita	Tulsa	7:35 PM
380	Sat.	Feb. 25/06	Oklahoma City	Colorado	7:05 PM
381	Sat.	Feb. 25/06	Amarillo	Lubbock	7:05 PM
382	Sat.	Feb. 25/06	Bossier-Shreveport	Youngstown	7:05 PM
383	Sat.	Feb. 25/06	Odessa	Austin	7:30 PM
384	Sat.	Feb. 25/06	Wichita	Fort Worth	7:30 PM
385	Sat.	Feb. 25/06	Laredo	Corpus Christi	7:35 PM
386	Sat.	Feb. 25/06	Memphis	Rio Grande Valley	7:35 PM
387	Sun.	Feb. 26/06	Odessa	Laredo	4:00 PM
388	Sun.	Feb. 26/06	Rio Grande Valley	Corpus Christi	5:05 PM
389	Sun.	Feb. 26/06	Tulsa	Wichita	5:05 PM
390	Tue.	Feb. 28/06	Tulsa	Memphis	7:05 PM
391	Tue.	Feb. 28/06	Austin	Youngstown	7:05 PM
392	Tue.	Feb. 28/06	Lubbock	Fort Worth	7:30 PM
393	Wed.	Mar. /06	Rio Grande Valley	Laredo	11:00 AM
394	Wed.	Mar. 1/06	Colorado	Wichita	7:05 PM
395	Wed.	Mar. 1/06	Austin	Youngstown	7:05 PM
396	Fri.	Mar. 3/06	Bossier-Shreveport	Amarillo	7:00 PM
397	Fri.	Mar. 3/06	Rio Grande Valley	Odessa	7:00 PM
398	Fri.	Mar. 3/06	Colorado	Lubbock	7:05 PM
399	Fri.	Mar. 3/06	Youngstown	Memphis	7:05 PM
400	Fri.	Mar. 3/06	Wichita	Fort Worth	7:30 PM
401	Fri.	Mar. 3/06	Laredo	Corpus Christi	7:35 PM
402	Fri.	Mar. 3/06	Oklahoma City	Tulsa	7:35 PM
403	Sat.	Mar. 4/06	Colorado	Odessa	7:00 PM
404	Sat.	Mar. 4/06	Amarillo	Lubbock	7:05 PM
405	Sat.	Mar. 4/06	Youngstown	Memphis	7:05 PM
406	Sat.	Mar. 4/06	Austin	Fort Worth	7:30 PM
407	Sat.	Mar. 4/06	Laredo	Corpus Christi	7:35 PM
408	Sat.	Mar. 4/06	Bossier-Shreveport	Oklahoma City	7:35 PM
409	Sat.	Mar. 4/06	Wichita	Tulsa	7:35 PM
410	Sun.	Mar. 5/06	Austin	Fort Worth	3:00 PM
411	Sun.	Mar. 5/06	Odessa	Amarillo	6:00 PM
412	Sun.	Mar. 5/06	Memphis	Oklahoma City	6:00 PM
413	Tue.	Mar. 7/06	Bossier-Shreveport	Rio Grande Valley	7:35 PM
414	Wed.	Mar. 8/06	Wichita	Colorado	7:05 PM
415	Wed.	Mar. 8/06	Fort Worth	Lubbock	7:05 PM
416	Thu.	Mar. 9/06	Corpus Christi	Odessa	7:00 PM
417	Fri.	Mar. 10/06	Youngstown	Bossier-Shreveport	7:05 PM
418	Fri.	Mar. 10/06	Fort Worth	Colorado	7:05 PM
419	Fri.	Mar. 10/06	Oklahoma City	Memphis	7:05 PM
420	Fri.	Mar. 10/06	Amarillo	Wichita	7:05 PM
421	Fri.	Mar. 10/06	Odessa	Laredo	7:30 PM

#	DAY	DATE	VISITOR	HOME	START TIME
422	Fri.	Mar. 10/06	Rio Grande Valley	Corpus Christi	7:35 PM
423	Fri.	Mar. 10/06	Austin	Tulsa	7:35 PM
424	Sat.	Mar. 11/06	Laredo	Odessa	7:00 PM
425	Sat.	Mar. 11/06	Oklahoma City	Bossier-Shreveport	7:05 PM
426	Sat.	Mar. 11/06	Fort Worth	Colorado	7:05 PM
427	Sat.	Mar. 11/06	Rio Grande Valley	Lubbock	7:05 PM
428	Sat.	Mar. 11/06	Youngstown	Memphis	7:05 PM
429	Sat.	Mar. 11/06	Austin	Wichita	7:05 PM
430	Sat.	Mar. 11/06	Amarillo	Tulsa	7:35 PM
431	Sun.	Mar. 12/06	Lubbock	Corpus Christi	5:05 PM
432	Sun.	Mar. 12/06	Rio Grande Valley	Amarillo	6:00 PM
433	Tue.	Mar. 14/06	Amarillo	Odessa	7:00 PM
434	Tue.	Mar. 14/06	Colorado	Tulsa	7:00 PM
436	Tue.	Mar. 14/06	Memphis	Bossier-Shreveport	7:05 PM
437	Tue.	Mar. 14/06	Lubbock	Rio Grande Valley	7:35 PM
446	Thu.	Mar. 16/06	Memphis	Corpus Christi	7:35 PM
438	Fri.	Mar. 17/06	Odessa	Amarillo	7:00 PM
439	Fri.	Mar. 17/06	Wichita	Bossier-Shreveport	7:05 PM
440	Fri.	Mar. 17/06	Fort Worth	Lubbock	7:05 PM
441	Fri.	Mar. 17/06	Colorado	Youngstown	7:05 PM
442	Fri.	Mar. 17/06	Tulsa	Austin	7:30 PM
443	Fri.	Mar. 17/06	Memphis	Laredo	7:30 PM
444	Fri.	Mar. 17/06	Corpus Christi	Rio Grande Valley	7:35 PM
445	Sat.	Mar. 18/06	Lubbock	Amarillo	7:00 PM
435	Sat.	Mar. 18/06	Fort Worth	Odessa	7:00 PM
447	Sat.	Mar. 18/06	Tulsa	Bossier-Shreveport	7:05 PM
448	Sat.	Mar. 18/06	Oklahoma City	Wichita	7:05 PM
449	Sat.	Mar. 18/06	Colorado	Youngstown	7:05 PM
450	Sat.	Mar. 18/06	Laredo	Austin	7:30 PM
451	Sat.	Mar. 18/06	Memphis	Rio Grande Valley	7:35 PM
452	Sun.	Mar. 19/06	Corpus Christi	Laredo	4:00 PM
453	Sun.	Mar. 19/06	Amarillo	Lubbock	5:05 PM
454	Sun.	Mar. 19/06	Tulsa	Wichita	5:05 PM
455	Tue.	Mar. 21/06	Amarillo	Odessa	7:00 PM
456	Tue.	Mar. 21/06	Bossier-Shreveport	Memphis	7:05 PM
457	Tue.	Mar. 21/06	Laredo	Rio Grande Valley	7:35 PM
458	Wed.	Mar. 22/06	Oklahoma City	Colorado	7:05 PM
459	Wed.	Mar. 22/06	Lubbock	Wichita	7:05 PM
460	Wed.	Mar. 22/06	Fort Worth	Youngstown	7:05 PM
461	Thu.	Mar. 23/06	Memphis	Bossier-Shreveport	7:05 PM
462	Fri.	Mar. 24/06	Rio Grande Valley	Amarillo	7:00 PM
463	Fri.	Mar. 24/06	Corpus Christi	Odessa	7:00 PM
464	Fri.	Mar. 24/06	Wichita	Colorado	7:05 PM
465	Fri.	Mar. 24/06	Austin	Memphis	7:05 PM
466	Fri.	Mar. 24/06	Fort Worth	Youngstown	7:05 PM
467	Fri.	Mar. 24/06	Lubbock	Oklahoma City	7:35 PM
468	Fri.	Mar. 24/06	Bossier-Shreveport	Tulsa	7:35 PM
469	Sat.	Mar. 25/06	Austin	Bossier-Shreveport	7:05 PM

CENTRAL HOCKEY LEAGUE

#	DAY	DATE	VISITOR	HOME	START TIME
470	Sat.	Mar. 25/06	Wichita	Colorado	7:05 PM
471	Sat.	Mar. 25/06	Odessa	Lubbock	7:05 PM
472	Sat.	Mar. 25/06	Tulsa	Memphis	7:05 PM
473	Sat.	Mar. 25/06	Fort Worth	Youngstown	7:05 PM
474	Sat.	Mar. 25/06	Laredo	Corpus Christi	7:35 PM
475	Sat.	Mar. 25/06	Amarillo	Oklahoma City	7:35 PM
476	Sun.	Mar. 26/06	Austin	Tulsa	2:00 PM
477	Sun.	Mar. 26/06	Corpus Christi	Laredo	4:00 PM
478	Sun.	Mar. 26/06	Oklahoma City	Wichita	5:05 PM
479	Sun.	Mar. 26/06	Lubbock	Amarillo	6:00 PM
480	Sun.	Mar. 26/06	Rio Grande Valley	Odessa	4:00 PM



Notes





2005-06 CHL TEAM DIRECTORY

CENTRAL HOCKEY LEAGUE OFFICE

4909 East McDowell Rd., Ste. 104

Phoenix, AZ 85008

Telephone: 480/949-8600

Fax: 480/949-8616

www.centralhockeyleague.com

AMARILLO GORILLAS

1934 Civic Circle

Amarillo, TX 79109

Telephone: 806/242-7825

Fax: 806/242-0079

www.amarillogorillas.com

AUSTIN ICE BATS

7311 Decker Lane

Austin, TX 78724

Telephone: 512/927-7825

Fax: 512/927-7828

www.icebats.com

BOSSIER-SHREVEPORT MUDBUGS

2000 CenturyTel Center Drive

Bossier City, LA 71112

Telephone: 318/752-2847

Fax: 318/752-2878

www.mudbugshockey.com

COLORADO EAGLES

1625 Pelican Lakes Pt., Suite 200

Windsor, CO 80550

Telephone: 970/674-1743

Fax: 970/674-9549

www.coloradoeagles.com

CORPUS CHRISTI RAYZ

1901 N. Shoreline Blvd. Suite 300

Corpus Christi, TX 78403

Telephone: 361/814-7825

Fax: 361/980-0003

www.ccrayz.com

FORT WORTH BRAHMAS

1314 Lake Street, Suite 200

Fort Worth, TX 76102

Telephone: 817/336-4423

Fax: 817/336-3334

www.brahmas.com

LAREDO BUCKS

6700 Arena Blvd.

Laredo, TX 78041

Telephone: 956/791-9192

Fax: 956/729-9393

www.laredobucks.com

LUBBOCK COTTON KINGS

1309 University

Lubbock, TX 79401

Telephone: 806/747-7825

Fax: 806/792-8396

www.cottonkings.com

MEMPHIS RIVERKINGS

4560 Venture Drive
Southaven, MS 38671
Telephone: 662/342-1755
Fax: 662/342-1156
www.riverkings.com

OKLAHOMA CITY BLAZERS

119 North Robinson Suite 630
Oklahoma City, OK 73102
Telephone: 405/235-7825
Fax: 405/272-9875
www.okcblazers.com

TULSA OILERS

9128 46th Street
Tulsa, OK 74145
Telephone: 918/632-7825
Fax: 918/632-0006
www.tulsaoilers.com

YOUNGSTOWN STEELHOUNDS

34 Federal Plaza West, Suite 200
Youngstown, OH 44503
Telephone: 330/747-7825
Fax: 330/746-1771
www.steelhounds.com

ODESSA JACKALOPES

5514 Champions Drive
Midland, TX 79706
Telephone: 432/520-2255
Fax: 432/520-8326
www.jackalopes.org

RIO GRANDE VALLEY KILLER BEES

2600 State Highway 336
Hidalgo, TX 78557
Telephone: 956/843-7825
Fax: 956/843-6644
www.killerbeehockey.com

WICHITA THUNDER

505 West Maple Street, Suite 100
Wichita, KS 67213
Telephone: 316/264-4625
Fax: 316/264-3037
www.wichitathunder.com

Notes

